

ATS-2

ATS-2 User's Manual

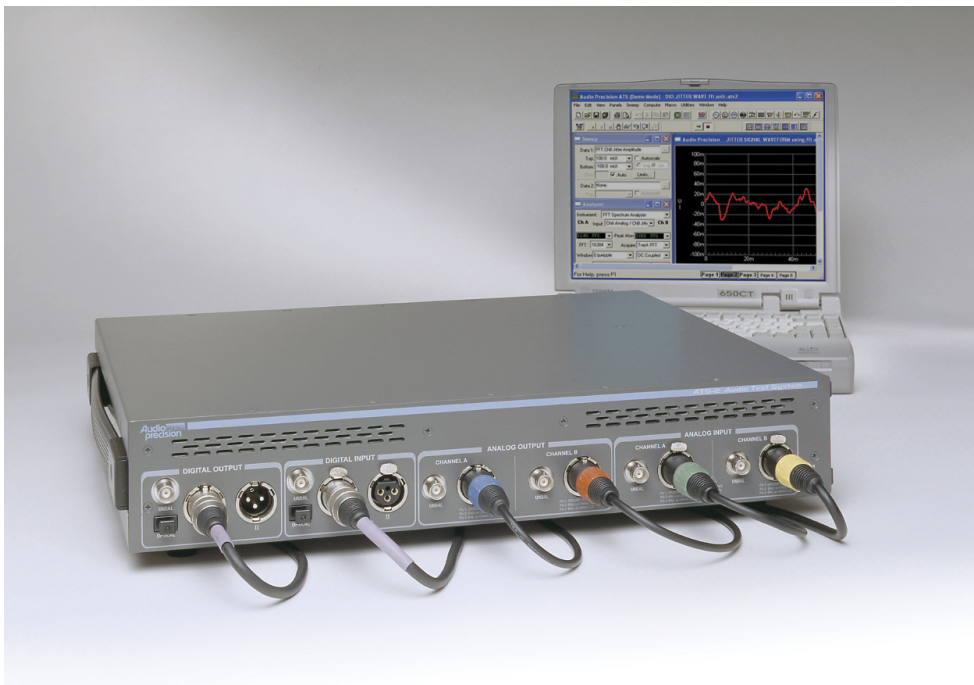

ATS-2 User's Manual



For ATS Software Version 1.6

Copyright © 2001–2007 Audio Precision, Inc.

All rights reserved.

Document part number 8211.0135 revision 4.

All content in this manual is owned by Audio Precision and is protected by United States and international copyright laws. Audio Precision allows its customers to make a limited number of copies of this manual, or portions thereof, solely for use in connection with the Audio Precision product covered by this manual. Audio Precision may revoke this permission to make copies at any time. You may not distribute any copies of the manual, apart from a transfer of ownership of the Audio Precision product.

Audio Precision®, System One®, System Two™, System Two Cascade™, System One + DSP™, System Two + DSP™, Dual Domain®, FASTTEST®, APWIN™, ATS™ and ATS-2™ are trademarks of Audio Precision, Inc. Windows is a trademark of Microsoft Corporation.

Published by:



Contents

Safety Information	xix
Safety Symbols	xx

Chapter 1

Introduction	1
ATS-2: an Overview	1
APIB	2
GPIB	2
About This Manual	2
ATS-2 Capabilities	3
Conceptual Architecture of ATS-2	4
Other Documentation for ATS-2	5
Getting Started with ATS-2	5
Online Help	6
The AP Basic User's Guide and Language Reference	6
The AP Basic Extensions Reference for ATS-2	7
Application Notes and TECHNOTES	7
GPIB Documentation for ATS-2	7

Chapter 2

The ATS Control Software	9
Overview	9
The User Interface	9
The Workspace	10
The ATS Panels	10
Panel Settings	11
Panel Readings	12
The ATS Menus	13
The File Menu	13
The Edit Menu	14
The View Menu	15
The Panels Menu	16

The Help Menu	18
Access to the Audio Precision Web site	19
The Status Bar	19
The Toolbars and ATS Icon Buttons	19
The Standard Toolbar	20
The Panels Toolbar	22
The Macro Toolbar	23
The Learn Mode Toolbar	23
The Quick Launch Toolbar	24
ATS Add-Ins	24
Working with Files and ATS	25
Test Files	25
Macro Files	25
Data Files	26
Waveform Files	26
Sample Files	27
The Log File	27
Keyboard Shortcuts	27
Function Keys	27
ATS-2 and GPIB	29
Chapter 3	
The ATS-2 Hardware	31
The ATS-2 Front Panel	31
The ATS-2 Rear Panel	32
Power Recycle Time	34
Chapter 4	
Signal Inputs and Outputs	35
The Analog Outputs	36
The Analog Inputs	37
The Digital Output	38
The Digital Input	39
Electrical vs. Data Characteristics Across Formats.	39
Chapter 5	
Signal Analysis with ATS-2	41
Analog Audio Signals	41
Analog Audio Generation and Output	41
Analog Audio Input	41
Digital Audio Signals	42
The Serial Digital Interface Signal	42
Digital Audio Generation	42
The Analyzer	42
Real-Time and Batch Mode Measurements	43

The Analyzer Instruments	43
Sweeps and Graphs	44

Chapter 6

The Analog Input Panel	45
Source	45
Input Termination Option	46
Peak Monitors	46
Input Ranging	47
Autoranging	47
Fixed Range	47
DC Coupling	47
Converter and Sample Rate Selection	48

Chapter 7

The Digital I/O Panel	51
The DIO Output Section	52
Format	53
Output Sample Rate-OSR	54
Voltage	54
Output Resolution	55
μ -Law and A-law Compression	55
Preemphasis	56
Scale Freq. by	57
Polarity	57
Send Errors	57
Changing the Parity bit	58
Sending a Validity bit	58
Jitter Generation	58
Jitter Type	59
Amplitude	59
Frequency	59
EQ Curve	60
The DIO Input Section	60
Format	61
Input Impedance	62
Single and Dual Connector Input Bitstream Selection	62
Single-Connector Mode	62
Dual-Connector Mode	62
Input Sample Rate-ISR	63
Voltage	63
Input Resolution	64
μ -Law and A-law Expansion	64
Deemphasis	65
Scale Freq. by	65

Rate Ref	66
Peak Monitors.	66
Data Bit Indicators	67
Error Indicators.	67
The Confidence Indicator	68
The Lock Indicator	68
The Coding Indicator	68
The Parity Bit Indicator	68
The Validity Bit Indicators	69
Jitter Measurement	69
The Status Bits panel	70
Transmit Status Bits	71
Consumer Format Status Bits	72
Professional Format Status Bits.	73
Local Address and Time of Day entry	73
CRC entry	74
Receive Status Bits	74
Hex Control and Display	75
Dual Connector Mode and Status Bits	75

Chapter 8

The Analog Generator	77
Test Signal Generation in ATS-2	77
Two Audio Signal Generators	77
Signals for Analog Measurements	77
The Analog Generator Panel.	78
Frequency Units	79
Output On/Off and Channel Selection	79
Auto On	79
Amplitude Control and Units	80
Choosing an Analog Generator Waveform.	81
Sine waveforms.	81
Wfm: Sine: Normal	82
Wfm: Sine: Var Phase.	82
Wfm: Sine: Stereo	83
Wfm: Sine: Dual.	83
Wfm: Sine: Shaped Burst	84
Wfm: Sine: EQ.	87
Squarewave	89
Wfm: Square	89
Intermodulation Distortion (IMD).	89
Wfm: IMD: SMPTE/DIN 4:1	89
Wfm: IMD: SMPTE/DIN 1:1	90
Noise Waveform	90

Arbitrary Waveforms	91
Setting the DAC Sample Rate	91
Special Waveforms	92
Wfm: Special: Polarity	93
Wfm: Special: Pass Thru	93
Configuring the Analog Outputs	94
Analog Generator References	95
“dBr” Amplitude Reference	96
Frequency Reference	96
Watts Reference	96
dBm Reference	96

Chapter 9

The Digital Generator	99
Test Signal Generation in ATS-2	99
Two Audio Signal Generators	99
Signals for Digital Measurements	99
The Digital Generator Panel	100
Frequency Units	101
Output On/Off and Channel Selection	101
Auto On	101
Channel Invert	102
Amplitude Control and Units	102
Choosing a Digital Generator Waveform	103
Sine waveforms	103
Wfm: Sine: Normal	104
Wfm: Sine: Var Phase	104
Wfm: Sine: Stereo	105
Wfm: Sine: Dual	105
Wfm: Sine: Shaped Burst	106
Wfm: Sine: EQ	107
Wfm: Sine: Burst	109
Wfm: Sine + Offset	111
Intermodulation Distortion (IMD)	112
Wfm: IMD: SMPTE/DIN 4:1	112
Wfm: IMD: SMPTE/DIN 1:1	112
Squarewave	112
Wfm: Square	112
White Noise	113
Wfm: Noise	113
Arbitrary Waveforms	114
Special Waveforms	115
Wfm: Special: Polarity	115
Wfm: Special: Pass Thru	116

Wfm: Special: Monotonicity	117
Wfm: Special: J-Test.	119
Wfm: Special: Walking Ones and Walking Zeros	119
Wfm: Special: Constant Value	120
Wfm: Special: Random	120
Dither	120
Dither Type	121
Digital Generator References	122
Volts for Full Scale Reference	122
Frequency Reference.	122
dBr Reference	122

Chapter 10

The Audio Analyzer	123
Overview	123
Loading the Audio Analyzer	124
Signal Inputs	125
The Level Meters.	126
Level Meter Units	126
AC and DC Coupling	127
Common-Mode Testing and Coupling Issues.	128
The Frequency Meters	128
Meter Ranging.	129
Autoranging.	129
Fixed Range	129
The Function Meters	130
Function Meter Measurement Functions.	130
Amplitude Function	131
2-Channel Ratio Function	132
Crosstalk Function	133
THD + N Functions.	134
THD + N Ratio Function	135
THD + N Amplitude Function.	136
Bandpass Function	136
SMPTE/DIN IMD Function	137
Phase Function	138
Function Meter Units	140
Function Meter Ranging	140
Detector Type	141
Detector Reading Rate	142
The Bandwidth and Filter Fields.	143
BW: The Highpass Filter.	143
BW: The Lowpass Filter	144
The "Fltr" Field.	145

Fltr: Weighting Filters	145
User Filters	147
Bandpass/Bandreject Filter Tuning	149
Fltr: Selecting Harmonics in Bandpass	150
References	151
Analyzer Analog References	151
Analyzer Digital References	152

Chapter 11

The Spectrum Analyzer	155
Introduction	155
Loading the Spectrum Analyzer	156
Signal Inputs	156
Peak Level Monitors	157
Acquiring, Transforming and Processing	157
The Acquisition Record	159
Acquisition Length	160
Transform Length	161
Spectrum Analyzer Window Selection	161
Hann Window	163
Blackman-Harris Window	163
Flat-Top Window	163
Equiripple Window	164
Hamming Window	164
Gaussian Window	164
Rife-Vincent Windows	164
None (No Window or Rectangular Window)	165
None, move to bin center	165
Quasi-AC Coupling	166
Averaging	167
Synchronous Averaging	168
Signal Alignment for Synchronous Averaging	169
Sync (without re-align)	170
Sync, re-align	170
Synchronous Averaging for "Move to bin center" operations	170
Synchronous Averaging and Frequency Domain Views	171
Power (Spectrum) Averaging	172
Display Processing	173
Waveform (time domain) Display Processing	173
Interpolate	174
Display Samples	174
Peak Values	175
Absolute Values	175

Graphic Aliasing	176
Spectrum (frequency domain) Display Processing	176
FFT Start Time	177
Triggering	177
Free Run	178
Auto	178
Fixed Sensitivity	178
Trig In (Ext)	179
Digital Gen	179
Analog Gen.	179
Line (Mains)	179
Jitter Gen	179
Fixed Level	179
Trigger Delay Time	180
Trigger Slope	180
Triggering with Synchronous Averaging	181
Without Re-alignment	181
With Re-alignment	181
Triggering with Quasi-AC Coupling	182
References	182
The Sweep Spectrum/Waveform Button	182
Acquired Waveform Files.	183
Saving Acquired Waveforms.	184
Opening Acquired Waveforms.	184
Combining Mono to Stereo	185
Compatibility of Acquired Waveform Files.	185
Chapter 12	
The Digital Interface Analyzer	187
Overview	187
ATS-2 Digital Interface Analyzer Analysis Tools.	187
Digital Interface Analyzer Components.	188
The Digital Interface Analyzer ADC	188
Digital Interface Analyzer Capabilities	188
Loading the Digital Interface Analyzer	189
The Digital Interface Analyzer panel	189
Digital Interface Analyzer Waveform Views	191
Interface Waveform	191
Eye Pattern	192
Jitter Waveform.	193
Digital Interface Analyzer Spectrum Views	195
Interface Spectrum	195
Jitter Spectrum	195
Digital Interface Analyzer Histograms.	197

Interface Amplitude Histogram	197
Interface Pulse Width Histogram	198
Interface Bit-Rate Histogram.	199
Jitter Histogram.	200
InterVuMenu.atsb	201
Digital Interface Analyzer panel settings	202
Wave Display processing (Time Domain view only)	202
Interpolate	203
Display Samples	203
Peak Values	204
Eye Pattern	204
Jitter Detection	204
Squarewave (Converter Clock) Jitter Detection	206
Averages (spectrum view only)	207
FFT Windows for the Digital Interface Analyzer	207
Trigger Source.	209
Triggering for squarewave acquisitions	210
Trigger Slope	210
Data Acquisition.	211
Receive Error Triggers	211
References.	211
Saving and Loading Interface Waveforms	212
Audible Monitoring in the Digital Interface Analyzer	212

Chapter 13

The Multitone Audio Analyzer.	213
Introduction	213
Overview: Multitone Testing	214
Multitone Waveform requirements.	215
Sample multitone waveforms.	215
Creating custom multitone waveforms	216
“Inside Information”: Multitone Generator Settings.	216
The Multitone Audio Analyzer panel	217
Signal Inputs	217
Peak Level Monitors.	218
Multitone Measurements.	218
Frequency Domain Views by default	218
Spectrum	219
Response	220
Distortion	221
Noise	222
Masking Curve	224
Crosstalk	225
Time Domain View	226

Frequency Resolution	226
Setting Multitone triggering resolution	226
Setting frequency resolution for rss summing	227
FFT Length	227
Processing	228
Triggering	229
Off	229
Digital Gen and Analog Gen	229
Tight, Normal and Loose	229
Trig In (Ext).	230
Trigger Delay	230
Phase Measurements	230
Channel A Phase.	231
Channel B Phase.	231
References	231
Other Considerations	232
Multitone Minimum Duration Requirements	232
Invalid Multitone Readings.	233
Acquired Waveform Files.	233
Saving Acquired Waveforms.	234
Opening Acquired Waveforms.	234
Combining Mono to Stereo	235
Compatibility of Acquired Waveform Files.	235
Creating Multitone Waveform Files	236
Multitone Creation Utility opening dialog box	236
Using Existing File Data.	238
File Options	239
Frequencies Menu	240
Editing the Frequency List.	240
Sweep Table Definition.	241
Creating an MS RIFF (.wav) File	242
Final Options.	243

Chapter 14

The Harmonic Distortion Analyzer	245
Introduction	245
Loading the Harmonic Distortion Analyzer.	247
Signal Inputs	247
The Fundamental Amplitude Meters	248
The Fundamental Frequency Meters	248
Harmonic Distortion Product Amplitude.	248
Harmonic Order Control	249
Distortion Product Bandwidth Limitations	249
Amplitude Units.	250

References	251
Steering Control	251
High Speed/High Accuracy Control	252
Sweeping and Graphing Results	254

Chapter 15

Sweeps and Sweep Settling	255
Introduction: Sweeps and Graphs	255
Batch Mode "Sweeps"	257
Plan Your Sweep	257
The Sweep Panel	258
Source 1	258
Settings or Readings?	259
Selecting a Sweep Source	259
Start and Stop Values	260
Source 1 Log or Lin Scales	260
Sweep Resolution	260
Linear Scale Steps	260
Logarithmic Scale Steps	261
X-Axis Divisions	261
Data 1	261
Selecting the Data 1 Reading	261
Top and Bottom Values	262
Data 1 Log or Lin Scales	262
Y-Axis Divisions	263
Data Limits	263
Data 2	263
Plotting Data as X-versus-Y	263
Data 3 through Data 6	264
Sweep Display Mode	265
Go / Stop / Pause	266
Repeat	266
Append	266
Appending a File	266
Stereo Sweeps	267
Single Point Sweeps	268
Nested Sweeps using Source 2	269
Pre-Sweep Delay	269
Pre-Sweep Delay and Auto On	269
Table Sweeps	270
External Sweeps	271
External Sweep Operation	272
Start and Stop	273
Spacing	273

End On	274
Min Lvl	275
Start On Rules	275
Some Hints.	276
External Stereo Sweep	277
External Single Point Sweeps	277
Time Sweeps.	277
Sweep Settling.	278
The Settling Panel.	279
Settling Concepts	280
Settling Delay Time	280
Algorithm Selection	280
Exponential Settling Algorithm	281
Flat Settling Algorithm.	282
Average Settling Algorithm	282
Settling Tolerance.	282
Settling Floor	282
Settling Issues for Specific Instruments	283
Timeout	283

Chapter 16

Graphs.	285
The Graph Panel	285
Zoom	286
The Graph Options Menu	287
Zoomout.	287
Zoomout to Original	288
Optimize	288
Copy to Sweep Panel	289
Display Cursors	289
Scroll Bars	292
Title and Labels	293
Comment	293
New Data.	293
Graph Buffer.	294
Graph Legend	294
Graph Legend / Data Editor Linkage.	296
Graphing invalid or suspect data	298
Trace Colors	298
Color Assignment for a New Test	299
Color Assignment for Multiple-Data-Set Sweeps	299
Color Cycling in Nested and Appended Sweeps	299
Color Cycling with Appended Files	300

Chapter 17

Bar Graphs	303
Creating a Bar Graph	303
Bar Graph Setup	304
Using a Bar Graph for Readings	305
Using a Bar Graph for Settings	306

Chapter 18

Editing Data and Setting Limits	307
The Data Editor	307
The Data Editor Panel	308
Columns	308
Rows	308
Data	308
Editing the Current Data in Memory	309
Saving ATS Data	310
Setting Limits	310
Making a Limit File	311
Attaching a Limit File	312
Using the Attached File Editor	313
Actions Upon Failure	314
More About Using AP Data Files	314

Chapter 19

Performing Computations on Data	317
The Compute Dialog Boxes	318
Compute: Normalize	319
Compute: Invert	320
Compute: Smooth	320
Compute: Linearity	321
Compute: Center	322
Compute: Delta	323
Compute: Average	324
Compute: Minimum	325
Compute: Maximum	325
Compute: Equalize	326
Compute Status	326
Clear All and Reset	327
Comparing Results with Original Data	327

Chapter 20

Printing and Exporting	329
Printing ATS Graphs	329
Page Setup	330
Print Setup	331

Printing a Graph	331
Print Preview	332
Printing ATS Data as a Table	332
Printing to a File	333
Exporting a Graph	334
Copying a Graph to the Clipboard	334
Copying a Window or Screen to the Clipboard	334
Chapter 21	
Monitoring	337
Headphone/Speaker Monitoring	337
The Volume Bar	337
Headphone/Speaker panel	338
The Monitor Outputs	339
The SOURCE Outputs	340
The FUNCTION Outputs	340
Chapter 22	
Sync/Ref, Trigger and Aux	341
SYNC/REF IN	341
Sync/Ref Input Panel	342
Reference Input Source	342
Squarewave frequency ranging	343
Frame Lock	344
Input Termination Impedance	344
Frequency	344
Input Frequency	344
Out of Range Indicator	345
TRIG IN	345
TRIG OUT and the Main Trigger Panel	345
Auxiliary Control Output and Input	348
Chapter 23	
Automating Tests	351
Introduction	351
Learn Mode	351
The Macro Editor	352
AP Basic Documentation	353
Chapter 24	
Regulation	355
Examples of Regulated Sweeps	359
Chapter 25	
Configuration and the Utilities Menu	361
The Configuration panel	361

General	362
Log	364
The Log File	364
Graph	366
Restoring the ATS-2 Hardware	367
Hardware Status	368
Turn All Outputs OFF / ON	368
Clear Log File	368
View Log File	368
Learn Mode	369
Multitone Creation	369

Appendix A

Units of Measurement	371
Introduction	371
Analog Amplitude Units	372
Digital Amplitude Units	376
Digital Data Units	378
Ratio Units	378
Relative Units	378
Frequency Units	379
Phase Unit	380
Time Units	380
DCX-127 Units	381
DCX-127 Amplitude Units	381
DCX-127 Resistance Units	381
DCX-127 Digital Input and Output Units	381

Appendix B

The Digital Audio Signal	383
The Serial Digital Interface Signal	384
Bi-phase Mark Encoding	385
The Frame and Subframe	385
Channel Status	386
Serial Interface Measurements	391

Appendix C

FFTs	393
The Fast Fourier Transform	393
Real Time vs. Batch Mode	393
Acquiring Data	394
The FFT Record	394
FFT Bandwidth	394
FFT Bin Width	395
FFT Record Looping	396

FFT Windowing	397
Synchronous FFTs	399
Graphing FFTs	400

Appendix D

User Downloadable Filters	401
Creating User Downloadable Filters	401
User Downloadable Filter Design Constraints:	401
MATLAB Downloadable Filter Support	403
ap_write_filter	404
Syntax	404
Description	404
Multiple Sample Rates	405
Filter Restrictions	405
Examples	405
ap_read_filter	406
Syntax	406
Description	406
Example	407

Appendix E

AP Waveform File Support	409
Exporting to .WAV	409
Operation	409
Tips and Tricks	410
Importing from .WAV	411
Operation	411
MATLAB support	412
ap_write_wave	412
Syntax	412
Description	412
Example	413
ap_read_wave	414
Syntax	414
Description	414
Example	415

Appendix F

Test and Macro Translators	417
Check the Web!	417
The Test Translator	417
Preparing S1.EXE and APWIN tests for translation	419
Macros for batch converting APWIN tests	419
Using the ATS-2 Test Translator	420
How the Test Translator Makes Decisions	421

Mapping Two Analyzers into One Analyzer.	421
Attached file considerations.	422
Reporting Test Translation Exceptions	422
The Macro Translator	422
Using the Macro Translator	423
Identifying the System when Importing Macros	424
Macro Translator Issues.	424
Numbers or Constants?	425
Libraries and the "With" Command	425
Referenced Files	425
Unavailable Features	425
Reporting Macro Translation Exceptions.	425
Mapping exceptions and substitutions	426
Analog Generator	426
Digital Generator	427
Audio Input	427
Analyzer Settings	428
Digital I/O.	430
Compute Functions.	430

Safety Information

Do NOT service or repair this product unless properly qualified. Servicing should be performed only by a qualified technician or an authorized Audio Precision distributor.

Do NOT defeat the safety ground connection. This product is designed to operate only from a 50/60 Hz AC power source (250 V rms maximum) with an approved three-conductor power cord and safety grounding. Loss of the protective grounding connection can result in electrical shock hazard from the accessible conductive surfaces of this product.

For continued fire hazard protection, fuses should be replaced ONLY with the exact value and type indicated on the rear panel of the instrument and discussed in the installation manual, *Getting Started with ATS-2*. The AC voltage selector also must be set to the same voltage as the nominal power source voltage (100, 120, 230, or 240 V rms) with the appropriate fuses. Different fuses are required depending on the line voltage.

The International Electrotechnical Commission (IEC 1010-1) requires that measuring circuit terminals used for voltage or current measurement be marked to indicate their Installation Category. The Installation Category is defined by IEC 664 and is based on the amplitude of transient or impulse voltage that can be expected from the AC power distribution network. This product is classified as INSTALLATION CATEGORY II, abbreviated “CAT II” on the instrument front panel.

Do NOT substitute parts or make any modifications without the written approval of Audio Precision. Doing so may create safety hazards.

This product is for indoor use—pollution degree 2.

Safety Symbols

The following symbols may be marked on the panels or covers of equipment or modules, and are used in this manual:



WARNING!—This symbol alerts you to a potentially hazardous condition, such as the presence of dangerous voltage that could pose a risk of electrical shock. Refer to the accompanying Warning Label or Tag, and exercise extreme caution.



ATTENTION!—This symbol alerts you to important operating considerations or a potential operating condition that could damage equipment. If you see this marked on equipment, consult the User's Manual or Operator's Manual for precautionary instructions.



FUNCTIONAL EARTH TERMINAL—This symbol marks a terminal that is electrically connected to a reference point of a measuring circuit or output and is intended to be earthed for any functional purpose other than safety.



PROTECTIVE EARTH TERMINAL—This symbol marks a terminal that is bonded to conductive parts of the instrument. Confirm that this terminal is connected to an external protective earthing system.

Chapter 1

Introduction



Figure 1. The Audio Precision ATS-2 audio test and measurement system.

ATS-2: an Overview

The Audio Precision ATS-2 is a powerful computer-controlled audio test and measurement system. The ATS-2 system consists of two key components:

- The ATS-2 hardware, which provides the connectors and circuitry necessary for proper signal interface and precise signal generation and analysis. The hardware is mounted in a compact aluminum and

steel chassis which can be installed in a standard 19 in wide equipment rack using optional mounting hardware.

- The ATS measurement software, which runs on a personal computer (PC) and provides all the control, display, report and automation functions for the ATS-2 system. The PC is not provided with ATS-2.

With the exception of the mains power switch on the rear panel, there are no knobs, dials, controls, readouts, meters or switches on the ATS-2 chassis. All of the measurement settings and adjustments are made on the PC.

The ATS control software will run under Microsoft Windows XP Professional Service Pack 2 or Microsoft Windows Vista Business Edition (32-bit) operating systems.

APIB

The control software communicates with the ATS-2 instrument through the Audio Precision Interface Bus (APIB). Several options have been provided for accessing APIB from your PC, including:

- The USB-APIB adapter.
- The APIB PCI card and cable.
- The APIB PCI Express card and cable.
- The APIB PCMCIA card and cable.

GPIB

With Option GPIB hardware installed, ATS-2 can also be controlled by the industry-standard IEEE 488.2 General Purpose Interface Bus (GPIB). See page 31 for more information about ATS-2 with GPIB.

About This Manual

You're reading the *ATS-2 User's Manual*. This is the primary operation and reference manual for the Audio Precision ATS-2 audio test and measurement system.

We recommend you begin by reading the separate introductory manual, *Getting Started with ATS-2*, which is discussed below.

Look in the *ATS-2 User's Manual* for

- Detailed discussions of every ATS-2 feature and every software panel, control and display;

- Reference information on audio test and measurement techniques, sample and utility file listings and much more.

A copy of the *ATS-2 User's Manual* is shipped with every ATS-2 system. The manual is also published as a PDF on the Audio Precision Resources Disc and on our Web site at ap.com.

ATS-2 Capabilities

ATS-2 is a comprehensive high-performance audio testing system.

- ATS-2 can make amplitude, frequency, THD+N, noise, phase, crosstalk, bandpass, and IMD measurements for analog or digital audio devices, and can perform a detailed analysis of individual harmonic distortion products.
- ATS-2 can perform measurements on audio signals using fast Fourier transform (FFT) analysis with advanced high-speed FFT analysis techniques available, including multitone recognition and analysis capability, frequency adjustment for bin centering, synchronous FFT processing, and advanced post-FFT analysis. FFT analysis can also provide time-domain, oscilloscope-type waveform display of signals. Non-audio signals such as interface signal jitter components can also be studied with FFT techniques.
- ATS-2 can use a combination of different measurement instruments and parameters to perform complex sweeps, and can display and print the results with a powerful graphing engine. ATS-2 offers control over instrument regulation and over sweep settling parameters. Pass/fail limits or equalization data can be attached to a sweep to constrain a particular measurement. A variety of computations can be performed on the measured data after acquisition. Sweep tests can be saved and recalled, and ATS-2 measurements can be automated by macros written in the AP Basic programming language.
- ATS-2 can examine the digital interface signal and perform elemental analysis of digital communication paths and assure the integrity of digitally transmitted data. ATS-2 can extract a variety of statistics from the digital waveform, such as the actual sample rate, the interface waveform voltage, the active and inactive data bits and flag bits. ATS-2 can measure the jitter in the interface signal. ATS-2 also has the capability of transmitting and receiving the full complement of status bits for both the AES3 (professional) and IEC60958-3 (consumer) digital audio interface signals.
- ATS-2's sample rate may be synchronized to an external AES signal, a squarewave, or an NTSC / PAL video source.

- The ATS-2 Performance Upgrade Option adds more power: a pair of high-bandwidth analog-to-digital converters to extend the analog analysis bandwidth from 30 kHz up to 120 kHz; and an additional Analyzer instrument called the Digital Interface Analyzer that can more closely examine the interface signal, providing eye patterns, histograms, waveform display and FFT spectrum analysis of the recovered jitter signal, and triggering from a number of different interface patterns and bits.

Conceptual Architecture of ATS-2

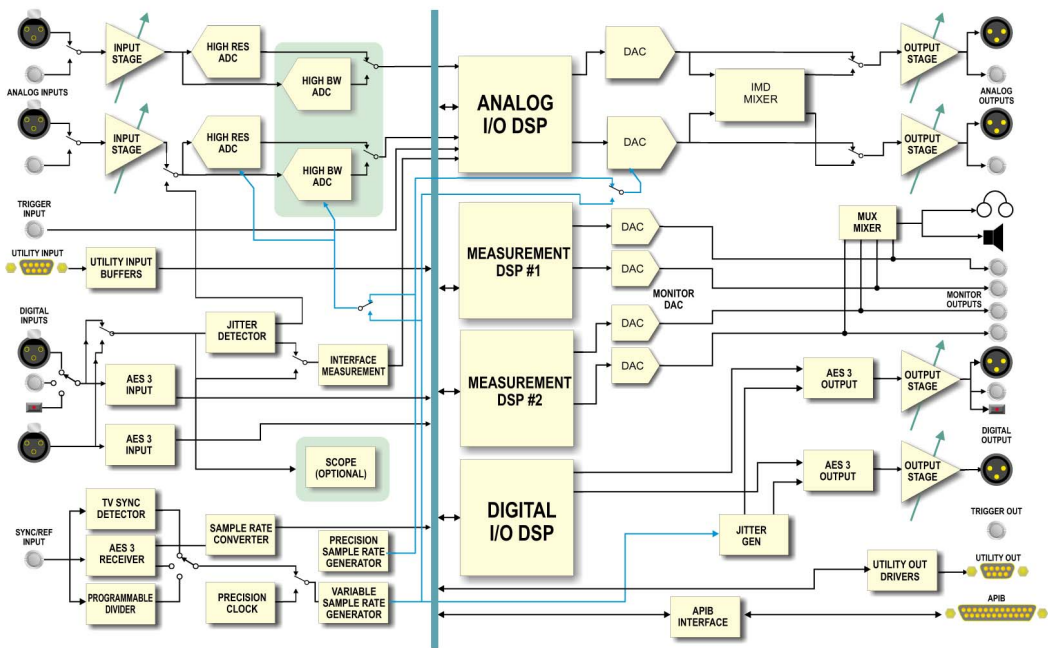

Figure 2. ATS-2 conceptual block diagram.

The functional components implemented in ATS-2 include two DSP-implemented audio signal generators, a suite of DSP-implemented audio, data and interface signal analysis capabilities, digital and analog input and output modules, and modules for synchronization and APIB communication.

All signal generation is performed in the digital domain. One of the two DSP signal generators is dedicated to the digital output. The signal from this generator, called the “Digital Generator,” is routed through the digital audio interface transmitter module and to the balanced, unbalanced and optical digital outputs. The output of the second DSP signal generator, the

“Analog Generator,” is converted to an analog signal by a digital-to-analog converter (DAC). The two-channel output of the DAC is conditioned and ranged for the balanced and unbalanced analog outputs.

All signal analysis is also performed in the digital domain in DSP. The digital input is routed through a digital audio interface receiver and applied to the Analyzer DSP. Analog inputs are first ranged and conditioned for domain conversion, and then are sampled by a high-resolution (or, optionally, a high-bandwidth) analog-to-digital converter (ADC) before being applied to the Analyzer.

Analog Domain / Digital Domain

Discussions of audio technology often place the signals into one or another of two realms: the analog domain or the digital domain. These terms provide a useful conceptual division.

Analog audio signals are analogies of the sound waves that they represent, varying in frequency and amplitude in a continuous fashion. In audio electronics, these are voltages and currents that are manipulated by modifying their amplitude or frequency. The term analog domain refers to signals represented and processed in this fashion.

Digital audio signals, on the other hand, are numerical representations of the sound waves. This representation is often carried on an electrical signal called the interface signal. Digital audio is processed mathematically in processes gathered together under the name of Digital Signal Processing, or DSP. The term digital domain refers to signals represented and processed in this fashion.

Other Documentation for ATS-2

Audio Precision publishes a wealth of material on our hardware and software products, about audio theory and on specific test and measurement techniques. Here are some important documentation resources:

Getting Started with ATS-2

We recommend that you read *Getting Started with ATS-2* before reading any other ATS-2 documentation. It is an introductory manual which will help you correctly set up ATS-2, install the software on your PC and familiarize yourself with the system. Inside *Getting Started with ATS-2* manual you'll find:

- hardware and software installation instructions;
- an introduction to the ATS-2 system;

- a look at the key features of the ATS control software;
- a group of Quick Guide tutorials, putting the ATS-2 system to use in simple tests; and
- ATS-2 specifications.

A copy of *Getting Started with ATS-2* is shipped with every ATS-2 system and is also published in electronic form as a PDF file, available on the Audio Precision Resources Disc and as a download from the Audio Precision Web site at ap.com.

Online Help

While you are running ATS, you will have much of the information contained in the *ATS-2 User's Manual* available to you instantly in the online Help system included as part of the ATS-2 system.

You can access the Help system while you are using ATS in a couple of ways:

- On the Menu bar, click **Help**. The Help menu offers commands to search the **Help Index**, browse through the **Help Topics**, or select an alternate Help library, **AP Basic Language**.
- ATS also has context-sensitive Help available. Almost every control and display on each software panel has a help topic associated with it. To view the topic, simply click on the field or control, then press the **F1** function key.

The AP Basic User's Guide and Language Reference

You can create simple or complex test and measurement *macros* to automate ATS-2 using AP Basic, the programming language included with the system. The same AP Basic language is also used to automate other Audio Precision PC-controlled systems and to interface with other programming languages.

The *AP Basic User's Guide and Language Reference* is published in electronic form as a PDF file, available on the Audio Precision Resources Disc and as a download from the Audio Precision Web site at ap.com.

You will also find online Help for AP Basic while running ATS. Click **Help > AP Basic Language Help** on the Help menu.

The AP Basic Extensions Reference for ATS-2

The *AP Basic Extensions Reference for ATS-2* is a large supplementary library of OLE / ActiveX automation commands for use specifically with ATS-2.

The *AP Basic Extensions Reference for ATS-2* is published in electronic form as a PDF file, available on the Audio Precision Resources Disc and as a download from the Audio Precision Web site at ap.com.

You will also find online Help for ATS-2 Basic Extension while running ATS. Click **Help > AP Basic Extension for ATS-2 Help** on the Help menu.

Application Notes and TECHNOTES

From time to time Audio Precision publishes technical papers such as AP Application Notes and TECH NOTES, which can help in your understanding of the operation of the ATS-2 system. Many of Audio Precision technical publications are available for download from our Web site at ap.com. New technical papers and online solutions are added on a regular basis.

Viewing and Printing PDF files

Audio Precision documentation is provided in Adobe Portable Document Format (PDF) format on the Audio Precision Resources Disc and on our Web site at ap.com.

You can view the PDF files using Adobe Acrobat Reader, a free program that can be downloaded from Adobe at www.adobe.com. You can also print PDF files using Acrobat Reader and a Windows compatible printer.

GPIB Documentation for ATS-2

With Option GPIB hardware installed, ATS-2 can also be controlled by the industry-standard General Purpose Interface Bus (GPIB).

Basic installation with GPIB is covered in *Getting Started with ATS-2*. For GPIB development and programming, order the *ATS-2 GPIB Programmer's Reference Manual*.

See page 31 for more information about ATS-2 with GPIB.

Chapter 2

The ATS Control Software

Overview

Most of your interaction with the ATS-2 system will be through the ATS control software. Once ATS-2 is plugged in, turned on and connected to your device under test (or *DUT*), you will be making all your adjustments and taking all your readings from your computer screen.

The ATS control software is a powerful and complex program, and most of this book is dedicated to exploring and explaining its many capabilities. In this chapter, we'll look at an overview of the software features and learn the basics of operating the system.

With Option GPIB hardware installed, ATS-2 can also be controlled by the industry-standard General Purpose Interface Bus (GPIB). See page 31 for more information about ATS-2 with GPIB.

The User Interface

Like many Windows applications, the ATS user interface has a menu bar, a status bar, toolbars, and a workspace. With these tools you can save test and data files, export and print measurement results, configure both the hardware and software to your needs, access online help, design and launch automated processes and, of course, open and operate the instrument panels where the core test and measurement work is performed.

The Workspace

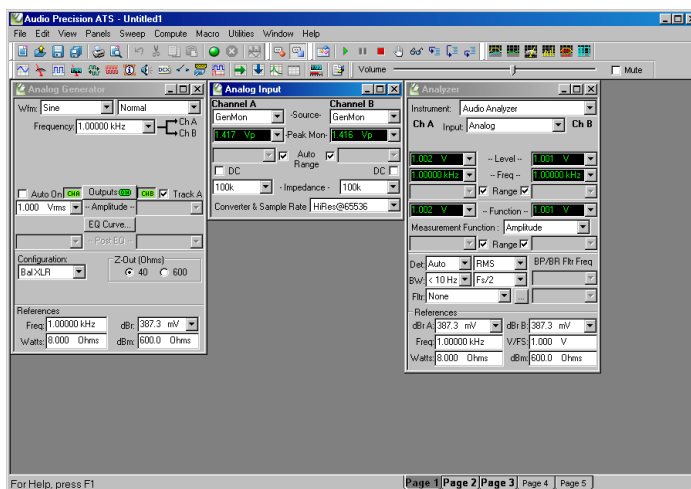

Figure 3. The ATS workspace.

The ATS workspace has 5 pages that you can select by menu commands (**View > Page #**) or by clicking the numbered tabs on the Status Bar. The workspace is like a multi-layered desktop where you can display and organize the instrument panels you are using for a particular set of tests.

Panels can be placed on any workspace page, and duplicated on more than one page. An instrument panel which appears on more than one page is simply a redundant display, for your convenience. The settings and results shown on redundant panels are identical, and a change made on one page is reflected on the others.

The ATS Panels

The real interaction with ATS-2 is done in control and measurement windows called *panels*. These can be thought of rather like the physical control panels often found on conventional test and measurement equipment, with range, function and trigger controls, ON and OFF switches, linear adjustment pots and sliders, numerical meter readouts, bar meters, X-Y waveform displays, graphs and so on.

The ATS panels are available through menu commands, toolbar icons and keyboard shortcuts.

You can control ATS-2 from just one or two ATS panels, if that's all your measurement requires. A more typical test might involve four or five panels; a complicated test, perhaps six or seven.

Figure 4.
An ATS Instrument Panel.

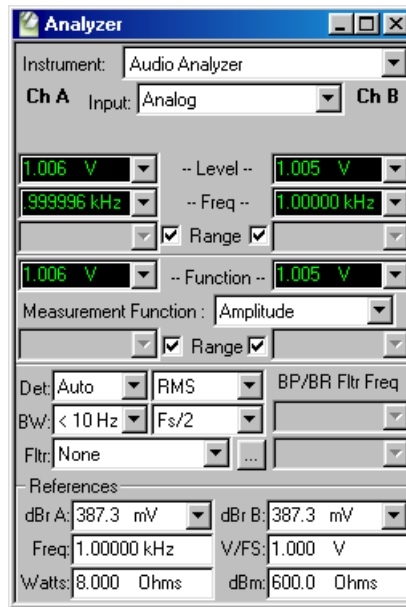

Although the ATS panels can all be placed on one workspace page, most users prefer to organize their workspace by placing panels on several different pages.

You can close a panel without canceling its function or effect; for example, you could set a signal's output voltage and frequency on the Analog Generator panel, turn the generator **ON**, then close the panel window. The signal will continue at the settings you've made until you open the panel again and turn the generator **OFF**.

Many of the ATS panels come in two sizes, the smaller having fewer commands and readouts visible, and the larger showing every option. The most commonly used size for each panel is set as its default size. Double-click on the panel title bar to expand or contract it.

Panel Settings

Settings for tests and measurements are made using several different types of controls on the panels:

- *Setting fields*, which come in several versions:
 - First is a text box, in which you can directly enter a value from the keyboard.
 - Second is a drop-down list box, in which you can make a selection from a set of choices.

Freq: .997000 kHz



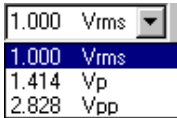

- Third is a combination of the first and second, a text box with an added drop-down list from which you can choose the units to express your value. See Appendix A, **Units of Measurement**.

Setting fields display dark (black or blue) text or numbers on a white field.



- **Check boxes**, which allow you to set non-exclusive conditions.

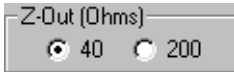

- **Option buttons**, which provide for exclusive conditions.



- **Browser buttons**, which open dialog boxes called *browsers*, which allow you to navigate lists of options, search for a file by browsing through a hierarchy of folders, and so on. Browser buttons are identified by the ellipsis mark (...).



- **Custom buttons** that control special functions, such as **GO**, **ON**, **OFF**, **1**, **0** and so on.

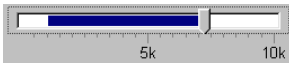

- **Sliders**, with which you can continuously adjust a value. Sliders are found on the Volume toolbar and on Bar Graph panels. Sliders can be operated by either the mouse pointer or by using the arrow keys.

Panel Readings

Results of tests or measurements are called *readings*, which ATS can display in several ways, as



- **Reading fields**, sometimes called *measurement fields* or *meters*. Reading fields come in two variations, with and without a drop-down list to select units. See Appendix A, **Units of Measurement**.

Reading fields always display green text or numbers on a black field.



- **Bar graphs**, which display values as a continuous colored bar like a conventional analog meter.

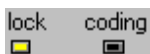

- **Status indicators**, which show the presence or absence of a condition by a small colored rectangle.

The ATS Menus

File Edit View Panels Sweep Compute Macro Utilities Window Help

The ATS Menu bar extends across the top of the ATS window and is always visible. In this chapter we will take a brief tour of some of the ATS menus. Details of menu options, controls and submenus will be explored in the chapters discussing specific ATS functions.

The File Menu

The File menu offers commands for opening, saving, appending, importing, exporting and printing ATS files, and access to the Quick Launch menu.



Since there are a number of different files types used by ATS, submenus are available (at the small black arrows ▶ accompanying some menu choices) to choose, for example, whether to **Save As a Test** or **Data** or **Macro** file.

The listings at the bottom of the File menu show the last tests opened by ATS, and provide a convenient way to quickly launch a previously used test. Simply click on the name of the test you would like to open.

The Edit Menu

Undo	Ctrl+Z
Cut	Ctrl+X
Copy	Ctrl+C
Paste	Ctrl+V
Copy Panel to Clipboard	
Set Analyzer Freq Ref	Ctrl+F4
Set Analyzer dBr Ref	F4
Set Generator Freq Ref	Ctrl+F3
Set Generator dBr Ref	F3
Reset Bar-graph Max/Min	F2
Insert Row Before	
Insert Row After	
Add Row to the End	
Delete Row	

The Edit Menu provides several groups of commands:

- **Undo** and **Cut**, **Copy**, and **Paste** provide editing functions for ATS text entries.
- **Copy Panel to Clipboard** places a bitmap image of the selected ATS panel on the Windows clipboard.
- The **Set Analyzer** and **Set Generator** commands provide an easy way to set reference levels and frequencies for the Analyzer and Generator panels for relative measurements. These are discussed in detail in the appropriate chapters.
- **Reset Bar-graph Max/Min** clears the gray minimum/maximum excursion bar from a selected Bar Graph display.
- The four last commands are only active when the ATS Data Editor is open and selected, and provide the means to insert, add and delete data rows.

The View Menu

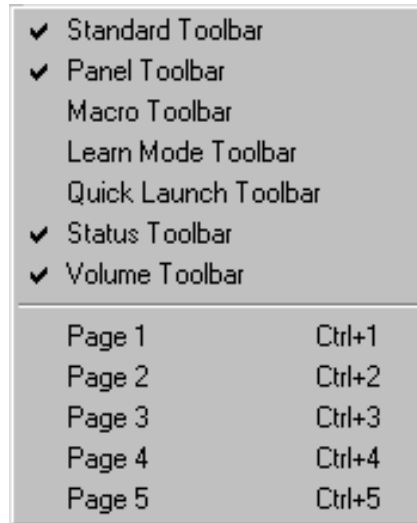

The View menu allows you to select which workspace page is visible, and whether or not the Status bar and any combination of Toolbars are displayed. A checkmark next to a View menu listing indicates that the selection is visible.

The Panels Menu

Analog Generator	Ctrl+G
Digital Generator	Ctrl+D
Analog Input	Ctrl+A
Analyzer	Ctrl+Y
Sweep	Ctrl+S
Graph	
Settling	
DCX	
Switcher	
Bar-Graphs	▶
Data Editor	
Digital I/O	Ctrl+I
Sync/Ref Input	
Status Bits	Ctrl+B
Headphone/Speaker	
Macro Editor	
Regulation	
Main Trigger	
Auxiliary Control IO	

The Panels menu shows all the control panels available in the control software. Click on a Panel name (or on its corresponding Toolbar button) to open a panel on the current workspace page. Panels can be duplicated on more than one page for convenience.

Closing a panel does not stop its activity. If a generator panel has been set to output a sine wave, or an analyzer panel to measure a voltage, these activities continue whether or not the panel is visible on any page.

The panel functions are discussed in detail in these chapters:

- Analog Generator panel (Ctrl+G). See Chapter 8.

- Digital Generator panel (Ctrl+D). See Chapter 9.
- Analog Input panel (Ctrl+A). See Chapter 6.
- Analyzer panel (Ctrl+Y). See Chapter 10.
- Sweep panel (Ctrl+S). See Chapter 15.
- Graph panel. See Chapter 16.
- Settling panel. See Chapter 15.
- DCX panel. The DCX-127 is an auxiliary multifunction instrument controlled by the ATS software. See the user's manual provided with the DCX-127.
- Switcher panel. The SWR-2755 series are auxiliary switching modules controlled by the ATS software. See the user's manual provided with the SWR-2755 switchers.
- Bar-Graphs panel. See Chapter 17.
- Data Editor panel. See Chapter 18.
- Digital I/O (Digital Input/Output or DIO) panel (Ctrl+I). See Chapter 7.
- Sync/Ref Input panel. See Chapter 22.
- Status Bits panel (Ctrl+B). See Chapter 7.
- Headphone/Speaker panel (Ctrl+H). See Chapter 21.
- Macro Editor panel. See Chapter 23.
- Regulation panel. See Chapter 24.
- Main Trigger panel. See Chapter 22.
- Auxiliary Control IO panel. See Chapter 22.

The Help Menu

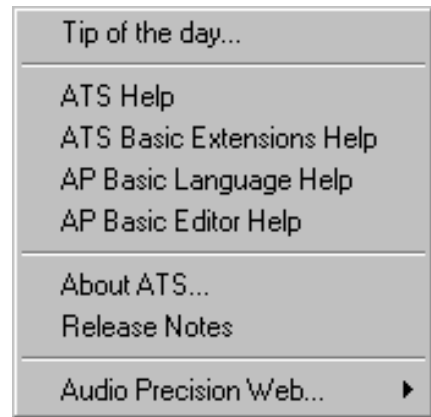

The Help menu gives you direct access to Online help and other information.

- Tip of the Day...
opens the next Tip, and allows you to enable or disable the Tips on software launch.
- ATS Help
links to the Contents tab of the Main Help file for the control software. Topics in this Main Help file can also be accessed as context-sensitive help pushing **F1** while the cursor is in a control or reading field.
- AP Basic Extensions help
is the Help file that lists every AP Basic ActiveX Automation (OLE) command specific to the ATS-2 instrument. Topics in this Help file can also be accessed as context-sensitive help pushing **F1** while the cursor is within command string in the AP Basic macro editor.
- AP Basic Language help
is a listing of the general (non-instrument-specific) commands available in AP Basic.
- AP Basic Editor help
provides topics about the use of the AP Basic macro editor.
- About ATS...
provides information about the specific release of ATS control software.
- Release Notes
is a shortcut to the Readme file.

[Access to the Audio Precision Web site](#)

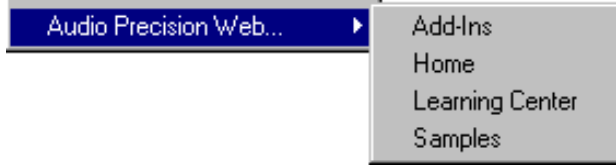

The last line on the Help menu,

- Audio Precision Web...▶

opens a submenu that lists the Web links currently provided to ATS. The list will vary from no links to many, depending upon the ATS installation and version and whether or not new links have been added or deleted through visits to the Audio Precision Web site at ap.com or other file maintenance.

You will typically have Web links to

- Add-Ins: additional software features for ATS, downloadable from the Audio Precision Web site. See page 24 for more information about Add-Ins.
- Home: the Audio Precision home page.
- Learning Center: the Tech Support Learning Center area at Audio Precision.
- Samples: the Tech Support Samples area at Audio Precision.

[The Status Bar](#)

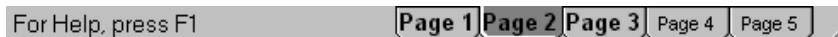

The Status bar runs across the bottom of the workspace and shows the workspace page tabs and various status notes as ATS operates.

[The Toolbars and ATS Icon Buttons](#)

ATS has 5 toolbars for quick access to panels and common functions. The toolbars can “float” at any location you place them on the workspace, or they can be “docked” or attached to the Menu bar. Whether docked or floating, the toolbars appear on every workspace page.

The toolbars display icon buttons, which, when clicked with the mouse, perform the associated functions.

The Standard Toolbar



The Standard toolbar gives you quick access to ATS file, printer and editing operations, as well as Sweep Stop/Start and FFT Time/Frequency domain switching. The buttons on the Standard toolbar are:



New Test resets the ATS control software to its defaults and initiates a new test.



Open Test presents you with a file browser window to select a previously saved test file (.ats2) for opening.



Save Test saves the current test as .ats2. If the test has not been previously saved, you will be presented with a browser window to choose a file name and location.



Save All saves not only the current test but any other files which are currently open, such as data or macro files. If any file has not been previously saved, you will be presented with a browser window to choose a file name and location.



Print prints the current graph to your default printer with the current settings.



Print Preview provides a preview window of your graph using the current default printer and the current settings.



Undo allows you to “back up” one step in your text editing.



Cut removes the selected text and places it on the Windows clipboard.



Copy places the selected text on the Windows clipboard.

Paste inserts text from the Windows clipboard at the cursor location.



Go starts a sweep.



Stop ends a sweep.



Toggle FFT Time/Frequency Domain switches the graph between a frequency-domain view (spectrum view) and a time-domain view (waveform view) for the same input signal acquisition. This feature is only available while using the Spectrum Analyzer, the Multitone Audio Analyzer and the Digital Interface Analyzer.



The Panels Toolbar



The Panels toolbar gives you quick access to 17 often-used ATS panels:



This button opens the Analog Generator panel. See Chapter 8.



This button opens the Analog Input panel. See Chapter 6.



This button opens the Digital Generator panel. See Chapter 9.



This button opens the Analyzer panel. See Chapter 5.



This button opens the Digital Input/Output (DIO) panel. See Chapter 7.



This button opens the Sync/Ref Input panel. See Chapter 22.



This button opens the Status Bits panel. See Chapter 7.



This button opens the Headphone/Speaker panel. See Chapter 21.



This button opens the DCX panel. See Chapter .



This button opens the Switcher panel. See Chapter .



This button opens the Auxiliary Digital I/O panel. See Chapter 22.



This button opens the Trigger panel. See Chapter 22.

This button opens the Sweep panel. See Chapter 15.



This button opens the Settling panel. See Chapter 15.



This button opens the Graph panel. See Chapter 16.



This button opens the Data Editor panel. See Chapter 18.



This button opens a new Bar Graph panel. See Chapter 17.



This button opens the Macro Editor panel. See Chapter 23.



The Macro Toolbar



The Macro toolbar offers 9 one-click operations for running and editing an AP Basic Macro. See Chapter 23, **Automating Tests**, for explanations of functions initiated by Macro toolbar buttons.

The Learn Mode Toolbar



Learn mode logs all your ATS operations as you perform them, building a script for automation purposes. The Learn Mode toolbar gives you the ability to turn the script recording function on and off with a click of the mouse. See Chapter 23, **Automating Tests**, for explanations of Learn Mode toolbar button functions.

The Quick Launch Toolbar



Quick Launch allows you to create and use custom toolbar buttons to open ATS tests, run AP Basic macros and even launch other Windows programs.

From the Main menu, choose **File > Quick Launch > Customize Quick Launch** to open the Quick Launch Configuration panel, where you can view or edit the existing Quick Launch commands or to add new commands of your own.

Figure 5.
The Quick Launch Configuration panel

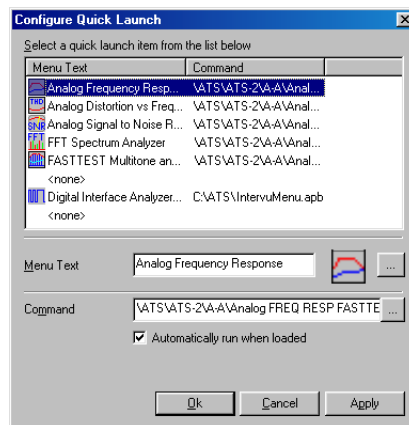

For each toolbar command, enter (or browse to) a command line with a complete path in the **Command** field. Then name the command in the **Menu Text** field, and choose toolbar button icon with the browser next to the **Menu Text** field. If you would like a macro from the Quick Launch toolbar to run immediately, check **Automatically run when loaded**.

To open the test, macro or program, click the button on the Quick Launch toolbar. In a default installation, the Quick Launch sample files are installed under ... \Program Files\Audio Precision\ATS-2\Quick Launch\.

ATS Add-Ins

An Add-In is a small software package that adds a specific set of features to ATS. Add-Ins can be downloaded and installed from the Audio Precision Web site.

An activated Add-In appears as an additional menu item in the appropriate ATS menu. If you have an Internet connection, you can browse the available Add-Ins using the Help menu (Help > Audio Precision Web... > Add-Ins) or go to our Web site at ap.com.

Working with Files and ATS

Part of the power of the ATS control software is its capability to create, store, load and run files which contain test setup and measurement data information, similar to the way a word processor or spreadsheet application uses document, template or script files.

Test Files

The key “document” created by the ATS software is the *test*, although ATS uses other file types as well. The measurement settings and readings, control software settings, associated file links and (if you’ve actually used the test on a DUT) the measurement data are all saved in the test file. These files can be opened, re-used, modified and re-saved as you wish.

The filename extension for test files is

- ATS test file—.ats2

When you first launch ATS, a default setup is loaded. You can modify this initial setup by opening or closing panels, changing configuration, making settings, running a sweep and so on. You can save your custom setup as a “test” under any name, in any folder you choose. ATS saves the instrument and sweep setup information, the input and output configuration, the panel sizes and positions, and so on. If you have run the test and produced results, the test data is also saved in the test file.

If you would like to return to a “clean slate” simply click the **New Test** button or the **New > Test** command on the File menu. ATS will discard your current settings and data and reload the default setup.

Macro Files

Another important ATS file type is the *macro* file, sometimes called a *procedure* file. As in other programs, a macro is a programming script which can automate program functions. ATS macros are written in the programming language AP Basic, which is included with ATS.

The extension for macro files is

- AP Basic macro file—.atsb

Data Files

ATS stores all data from test results in memory as the test is run. As mentioned before, this information is saved along with panel and sweep setup information in a test file. The data can also be viewed and edited in a panel called the Data Editor, and can be saved as a separate file.

ATS can open saved data files in order to attach previous data to a current test. There are four different data file types, each of which has a different use within ATS.

The extensions for data files are

- AP data file—.atsa
- AP limit file—.atsl
- AP sweep file—.atss
- AP EQ file—.atsq

The four ATS data file types are identical except for their file name extensions. Data saved as .atsa, .atsl, .atss or .atsq files can later be used for any data function. The different extensions serve to help organize data files and to indicate the intended use of the data.

It is also possible to export ATS data as an ASCII text file for use in a spreadsheet or text editor program. The extension for an ASCII data file is:

- AP ASCII data file—.atsx

Waveform Files

For certain analyzer functions performed in DSP, including FFT displays and some types of interface analysis, ATS acquires a short sample of the digital waveform. These samples can be saved as waveform files and later opened by ATS for further use.

The extensions for waveform files are

- AP stereo waveform file (generator)—.ags
- AP stereo waveform file (analyzer)—.aas
- AP mono waveform file (generator)—.agm
- AP mono waveform file (analyzer)—.aam
- AP digital interface waveform file—.aai

Sample Files

Dozens of sample tests and associated files for the ATS-2 are provided on the Audio Precision Resources Disc and are also available for download from our Web site at ap.com. You can use the test samples as examples or as starting points for your own custom tests.

The Log File

ATS can generate a log file, which can contain error messages, file activity, sweep activity, graph information and pass/fail test results. The log file can be viewed on the screen or printed. The extension for the log file is

- AP log file—.alg

The log file is enabled and set up on the Configuration panel, and is discussed in detail in Chapter 25.

Keyboard Shortcuts

Many of the ATS Menu and Toolbar commands are also available as keyboard shortcuts. The Sweep **Start** command, for example, is **F9**; the Analog Generator panel can be brought to the screen with **Ctrl+G**.

Keyboard shortcuts are identified in the chapters which discuss the functions they command, and are listed as alternative commands in the ATS menus. They are all listed here as well.

Function Keys

- **F1—Help**
Context-sensitive Help—brings the Help topic associated with the currently selected panel feature to the screen.
- **F2—Resets Min/Max**
In a Bar Graph, resets the minimum/maximum value history.
- **F2—Edit**
In the Data Editor, enables editing within a data cell.
- **F3—Set Gen Ampl. Ref**
Sets the Analog Generator dBr reference value to the current Analog Generator amplitude setting.
- **Ctrl-F3—Set Gen Freq. Ref**
Sets the Analog Generator frequency reference value to the current Analog Generator frequency setting.

- **F4—Set Analyzer Ampl. Ref**
Sets the Audio Analyzer and the Harmonic Distortion Analyzer dBr reference value to the current Analyzer amplitude reading.
- **Ctrl-F4—Set Analyzer Freq. Ref**
Sets the analyzer frequency reference value to the current value displayed in the analyzer frequency counter.
- **F6—Re-Transform without Acquire**
(for FFT-based, batch mode instruments: Spectrum, Digital Interface and Multitone Analyzers)
Performs a new transform on the acquired data and graphs the results.
- **Ctrl-F6—Re-Graph without Transform or Acquire**
(for FFT-based, batch mode instruments: Spectrum, Digital Interface and Multitone Analyzers)
Graphs the transform results currently in DSP memory without performing a new transform.
- **F7—Graph or Re-Graph**
Graphs the data currently in computer memory.
- **Alt-F8—Store in Graph Buffer**
Stores the present trace or traces to the Graph Buffer memory.
- **F8—Display Graph Buffer**
Displays the trace or traces currently stored in the Graph Buffer memory.
- **Ctrl-F8—Clear Graph Buffer**
Deletes any trace or traces in the Graph Buffer memory.
- **F9—Sweep Start (Go)**
Starts a new Sweep; equivalent of Sweep **Start** or clicking the **Go** button.
- **Ctrl-F9—Sweep with Append**
Starts a new Sweep while retaining previous data; appending the new sweep to the old; equivalent of clicking **Go** when **Append** box is checked.
- **Alt-F9—Sweep and Repeat**
Starts a new Sweep in repeating mode; equivalent of clicking **Go** when **Repeat** box is checked.
- **F10—Pause Sweep**
The “sweep pause button.” Toggles a sweep from running to paused and back again.

- **F12—Kill Outputs**

The “panic button.” Turns off all generator outputs.

- **Ctrl-F12—Revive Killed Outputs**

Turns on any generator outputs previously turned off by the panic button.

ATS-2 and GPIB

With Option GPIB hardware installed, ATS-2 can also be controlled by the industry-standard General Purpose Interface Bus (GPIB).

Chapter 3

The ATS-2 Hardware

There are no controls or displays on the ATS-2 hardware chassis. Instead, the ATS-2 user interface is through the controls and displays of the ATS control software (ATS.EXE), running on the personal computer connected to the ATS-2 chassis by the Audio Precision Interface Bus (APIB).

The hardware module Option GPIB brings the General Purpose Interface Bus (GPIB) to ATS-2. GPIB is an industry-standard interface that enables ATS-2 to be controlled by a computer running third party or custom-designed software. Operation with GPIB is not covered in this manual.

For both APIB and GPIB use, all signal generation and analysis is performed in the ATS-2 hardware, including storage of signals acquired for DSP waveform display or FFT analysis.

The ATS-2 Front Panel

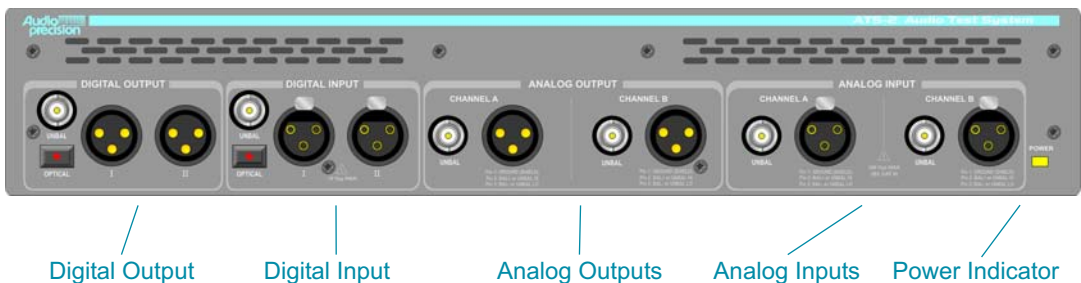

Figure 6. ATS-2 Front Panel.

The main digital and analog signal input and output connectors are on the ATS-2 front panel, with a lighted “power on” indicator.

- **THE DIGITAL OUTPUT**
The ATS-2 digital output can be routed to the balanced XLR male “I” connector, the unbalanced BNC connector or the optical connector by software selections. When the dual-connector output configuration is selected, both the “I” and “II” connectors are used together.
- **THE DIGITAL INPUT**
The ATS-2 digital input can be routed from the balanced XLR female “I” connector, the unbalanced BNC connector or the optical connector by software selections. When the dual-connector input configuration is selected, both the “I” and “II” connectors are used together.
- **THE ANALOG OUTPUTS**
The ATS-2 analog outputs for both “A” and “B” channels are available as balanced signals at the XLR male connectors and as unbalanced signals on the BNC connectors.
- **THE ANALOG INPUTS**
The XLR female balanced connectors and the BNC unbalanced connectors for both “A” and “B” channels are routed to the ATS-2 analog inputs.

See Chapter 4, **Signal Inputs and Outputs** for more information about the ATS-2 inputs and outputs and the software panels associated with them. Refer to the manual *Getting Started with ATS-2* for detailed input and output specifications.

The ATS-2 Rear Panel

The only switch on the ATS-2 hardware is the mains power switch. The power switch is located on the left side of the rear panel in the power entry module, which also contains the power cord connector, the mains voltage selector and the power fuse(s).

The ATS-2 monitor and headphone, sync/ref, trigger, auxiliary control and APIB connections are also mounted on the rear panel.

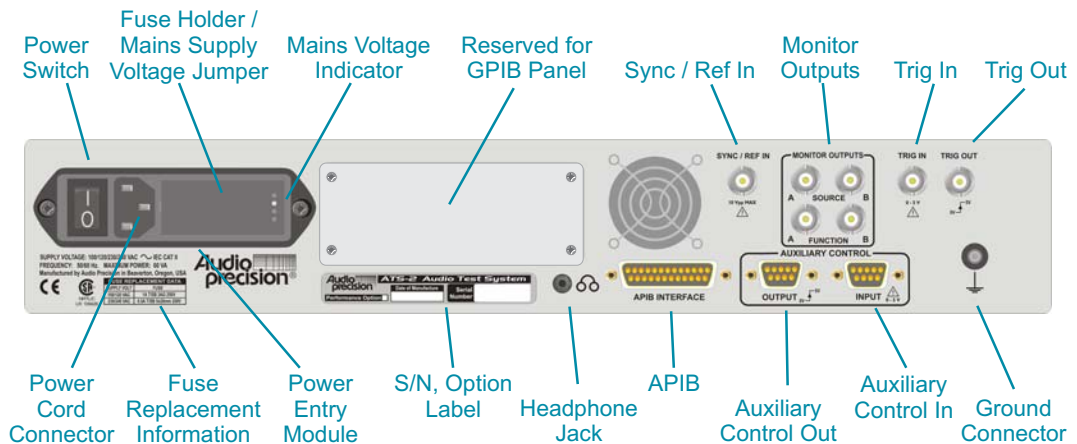

Figure 7. ATS-2 Rear Panel.

- **POWER ENTRY MODULE**—this module includes the
 - **POWER SWITCH**—This switch turns the main power supply to the ATS-2 hardware ON (I) or OFF (O). To assure stable operation after ATS-2 is switched off or loses power, wait 15 seconds before re-applying power.
 - **POWER CORD CONNECTOR**—This is a standard grounded connector for the mains power supply cord.
 - **FUSE HOLDER / MAINS SUPPLY VOLTAGE JUMPER**—Open the cover of the fuse holder (see the separate manual *Getting Started with ATS-2*) for access to the mains power fuse and the mains supply voltage configuration jumper card.
 - **MAINS SUPPLY VOLTAGE INDICATOR**—The white tip of the plastic indicator on the voltage configuration jumper card appears in one of four small holes to show the mains voltage selection.
- **FUSE REPLACEMENT INFORMATION**—This chart lists the fuse values required for correct operation at the four supply voltage options.
- **S / N, OPTION LABEL**—This label lists the Audio Precision serial number, date of manufacture and hardware Performance Upgrade Option, if installed.
- **HEADPHONE JACK**—This is a 3.5 mm stereo jack suitable for driving headphones or other audio monitors.
- **RESERVED FOR GPIB PANEL**—This blank panel can be removed for factory installation of the GPIB configuration option, adding GPIB (IEEE-488.2 General Purpose Interface Bus) functionality to ATS-2. Operation under GPIB control is not covered in this manual.

- **APIB INTERFACE**—This connector provides the two-way Audio Precision Interface Bus connection between ATS-2 and the personal computer running the ATS control software.
- **SYNC / REF IN**—This connector provides an additional input for an external digital audio signal, a squarewave or an NTSC/PAL video signal for sample rate synchronization (“house sync”). This connector also serves as the input for the **Pass-Thru** generator function.
- **MONITOR OUTPUTS**—These connectors provide audio signal monitor outputs. The SOURCE monitor signals are routed from the input of the ATS-2 Analyzer, at the Level meters; the FUNCTION monitor signals are routed from the Analyzer Function meter, monitoring the reading in process.
- **TRIG IN**—This connector provides an input to trigger or initiate certain measurement functions.
- **TRIG OUT**—This connector provides an output for the purpose of triggering an external oscilloscope.
- **AUXILIARY CONTROL OUT**—A 9-pin DSUB connector to enable ATS-2 to control other instruments.
- **AUXILIARY CONTROL IN**—A 9-pin DSUB connector for external control and display input.
- **GROUND CONNECTOR**—This is a chassis ground connection suitable for bare wire or banana plug connection.

Power Recycle Time

To assure stable operation after ATS-2 is switched off or loses power, wait 15 seconds before re-applying power.

Chapter 4

Signal Inputs and Outputs

This chapter discusses the hardware aspects of ATS-2's main analog and digital signal inputs and outputs. Monitor connections are discussed in Chapter 21, while sync, reference and auxiliary connections are examined in Chapter 22.

The primary signal input and output connectors are mounted on the ATS-2 front panel.

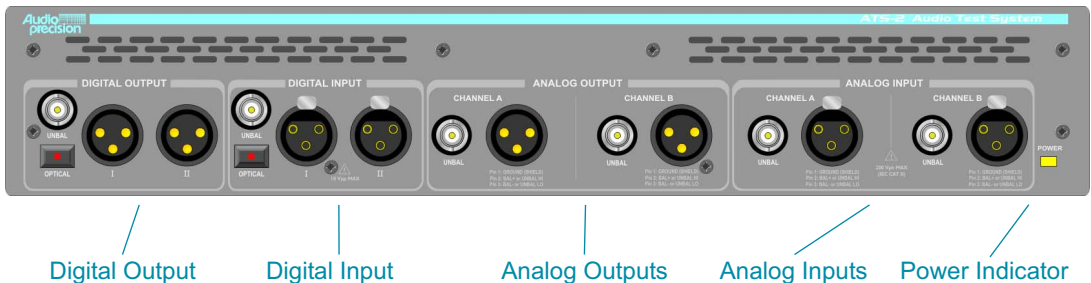

Figure 8. ATS-2 Front Panel

The analog inputs are configured on the software Analog Input panel; the analog outputs are controlled from the Analog Generator panel.

A digital audio signal has two aspects: the electrical interface signal and the information carried in the interface data stream. Selection and electrical configuration of the digital interface signal input and output is accomplished from the Digital Input/Output (DIO) panel, as are many characteristics of the data stream itself. Additionally, features of the audio embedded in the data stream are controlled from the Digital Generator panel.

See **Specifications** in *Getting Started with ATS-2* for detailed hardware specifications for both the analog and digital inputs and outputs.

The Analog Outputs

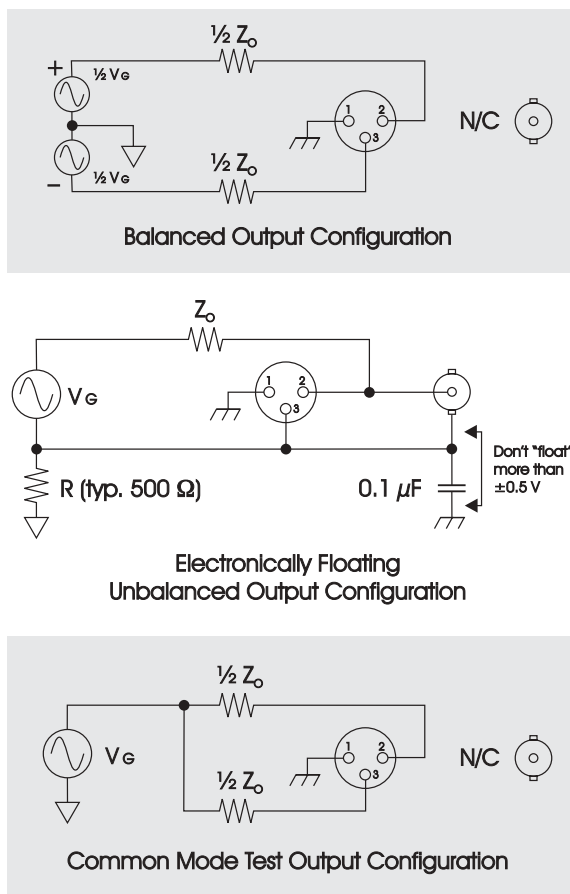

Figure 9. Analog Output Circuit Configurations, simplified.

The ATS-2 analog outputs can provide a balanced output signal, an unbalanced signal or a common-mode-test signal. The software output configuration selection affects both Channels A and B.

The balanced signal is available on the XLR male connector, with pin 2 wired to the “high” leg of the signal, pin 3 to the “low,” and pin 1 to ground. In balanced mode the BNC connector for that channel is disconnected.

When an output is set to unbalanced, the signal is available at both the XLR male connector and the BNC connector simultaneously. In this configuration pin 1 of the XLR is wired to ground; the BNC shell and pin 3 of the XLR are held to the unbalanced signal low; and the center pin of the BNC and pin 2 of the XLR carry the signal high.

Do not “unbalance” the balanced outputs by connecting pin 2 or pin 3 of an XLR output connector to ground, as might be done with adapter cables. Connecting the ATS-2 balanced outputs to an unbalanced load will produce distorted waveforms. Use the unbalanced output connectors for an unbalanced load.

The common-mode test signal is applied to both pins 2 and 3 of the XLR connector, while pin 1 is grounded. The BNC connector is disconnected in the common-mode configuration.

Three impedance configurations are available for the ATS-2 at the time of ordering. Changes in impedance configurations must be performed at the factory or by an authorized Audio Precision representative.

- **Standard Impedance Configuration**

With the standard impedance configuration, output impedances can be set to 40 Ω or 150 Ω in the balanced configuration and to 20 Ω or 50 Ω in the unbalanced.

- **Optional European Impedance Configuration**

With the optional European impedance configuration, output impedances can be set to 40 Ω or 200 Ω in the balanced configuration and to 20 Ω or 50 Ω in the unbalanced.

- **Optional 600 Ω Impedance Configuration**

With the optional 600 Ω impedance configuration, output impedances can be set to 40 Ω or 600 Ω in the balanced configuration and to 20 Ω or 50 Ω in the unbalanced.

Output selection and impedance are set on the Analog Generator panel, discussed in Chapter 8.

The Analog Inputs

The XLR female balanced connectors and the BNC unbalanced connectors (both A and B channels) are connected to the ATS-2 analog inputs. Input selection is made on the Analog Input panel, discussed in Chapter 6.

In the standard or European impedance configurations, the input load at each of the analog inputs is fixed at a high impedance, greater than 100 k Ω .

If you have ordered your ATS-2 with the 600 Ω impedance option, an additional field will be shown on the Analog Input panel and you will have the choice of an input load of either **100 k Ω** or **600 Ω** . This choice affects both balanced and unbalanced inputs. See Chapter 6.

We recommend that you do not use both the balanced and unbalanced analog inputs of either channel simultaneously. Circuit conditions external to ATS-2 could degrade the system performance. However, you may use the balanced input of one channel and the unbalanced input of the other channel at the same time.

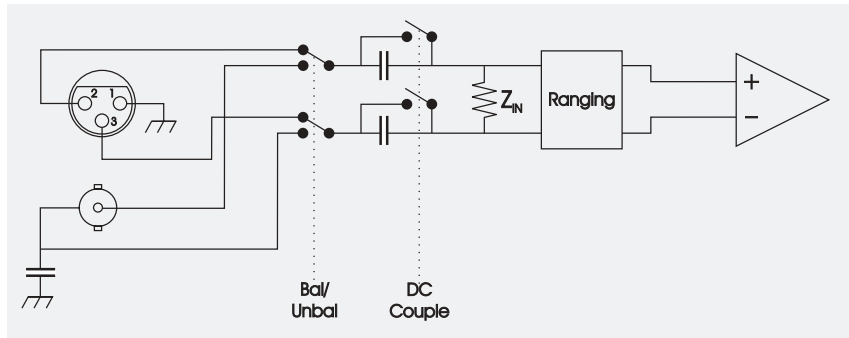

Figure 10. Analog Input Circuit Configurations.

The Digital Output

The digital output signal is available as a balanced electrical signal at the XLR male connectors, in either single or dual-connector configurations. This output satisfies the electrical requirements of the AES3 professional interface standard. Use the connector labeled “I” for the customary single-connector configuration, and both “I” and “II” for the optional dual-connector configuration.

The output signal is also available as an unbalanced electrical signal at the BNC connector. This output satisfies the electrical requirements of both the AES3id professional standard and the IEC60958-3 standard, which is compatible with the S/PDIF consumer digital interface format.

The XLR and BNC digital outputs are calibrated with the assumption that the signal is terminated in the proper impedance (110 Ω for the balanced output; 75 Ω for the unbalanced). If the signal isn’t properly terminated the actual output voltage will be different from the voltage specified in the DIO panel.

The digital output is also provided as an optical signal compatible with the Toslink® interface.

Digital output selection and interface configuration are set on the DIO panel, page 51.

We recommend that you do not use the balanced and unbalanced digital outputs simultaneously. Circuit conditions external to ATS-2 could degrade the system performance. However, the optical output can be used simultaneously with either the balanced or unbalanced digital output.

The Digital Input

The digital input accommodates the same interface formats as the digital output. The XLR female connectors provide a balanced input for satisfying the electrical requirements of an AES3 professional format digital audio signal in either single or dual-connector configurations. Use the connector labeled “I” for the customary single-connector configuration, and both “I” and “II” for the optional dual-connector configuration. Input termination can be set on the DIO panel to **HiZ** (approximately 10 k Ω) or to **110 Ω** , the AES3 standard.

The BNC input connector is configured for an unbalanced digital signal satisfying the electrical requirements of both the AES3id professional format and the IEC60958-3 (S/PDIF) consumer interface format. Input termination can be set on the DIO panel to **HiZ** (approximately 10 k Ω) or to **75 Ω** .

The optical input is compatible with the Toslink® interface.

Digital input selection and interface configuration are set on the DIO panel, page 51.

We recommend that you do not maintain connections to the balanced and unbalanced digital inputs simultaneously. Circuit conditions external to ATS-2 could degrade the system performance. However, a connection to the optical input can be maintained simultaneous to a connection to either the balanced or unbalanced digital input. The DIO panel will select only one input at a time.

Electrical vs. Data Characteristics Across Formats

The various standards defining digital audio interface formats cover a broad number of characteristics, including line impedance, signal voltage, acceptable rise-time and jitter figures, and also the information carried as data on the interface.

Although the ATS-2 balanced and unbalanced digital connections do satisfy the electrical requirements for certain standards, as mentioned above, selecting the balanced or unbalanced digital input or output does not configure the digital data stream. This is done in other fields on the DIO panel

and on the Status Bits panel. See Chapters 7 and Appendix B for a full discussion of the digital data stream and status bits.

It is entirely possible to route digital audio data configured to the professional format standard (AES3) to the unbalanced output with voltage and impedance characteristics matching the consumer format standard (IEC60958-3), as it is possible to route consumer-formatted data to the balanced output, at the professional format voltage levels and impedance values.

Chapter 5

Signal Analysis with ATS-2

This chapter gives a brief overview of the tools ATS-2 provides for signal analysis and serves as an introduction to test and measurement techniques using ATS-2. ATS-2 can test and measure analog audio signals, the serial digital interface signal, and the digital audio signal carried on the interface.

For each type of signal, ATS-2 provides the capability to generate a variety of stimulus signals for input to the device under test (DUT), and the capability to analyze the output of the DUT in a number of different ways.

References link the key topics introduced here to later chapters where they are examined in detail.

Analog Audio Signals

Analog Audio Generation and Output

ATS-2 can produce a wide range of analog audio signals in the Analog Generator (see Chapter 8) to be applied to the input of an analog DUT as stimulus signals.



The Analog Generator panel also provides controls to select and configure the analog outputs.

The Analog Generator and the Digital Generator (discussed below) are similar in appearance and function.

Analog Audio Input

The ATS Analog Input panel provides the means to select and configure the analog inputs. The signals routed through the Analog Input panel are then converted to digital audio signals for analysis, using high-performance analog-to-digital converters (ADCs). After conversion, the signals



are routed to the ATS-2 Analyzer, where a number of different analysis instruments can be applied.

See Chapter 6 for detailed information on the Analog Input panel. The Analyzer is discussed below.

Digital Audio Signals

The Serial Digital Interface Signal



Digital audio is transmitted and received on the serial digital interface signal. The interface signal has characteristics which can be measured and tested, and ATS provides the capability to do this in the Digital Input / Output (DIO) panel, and to a greater extent in the Analyzer instrument called the Digital Interface Analyzer, which is available as a component of the Performance Upgrade Option.

Since the interface signal carries the digital audio, some characteristics of the interface signal can be observed by measuring the audio effects on the embedded signal.

The DIO also configures ATS-2 to receive the data stream from the digital input, and passes the embedded audio on to other ATS-2 functions.

All the input and output configuration of the digital interface signal is accomplished from the DIO panel. See Chapter 7 for detailed information on the DIO panel.

Digital Audio Generation



ATS-2 can produce a wide range of digital audio signals in the Digital Generator (see Chapter 9). After generation, the digital audio is embedded in the serial digital interface signal before being applied to the input of a digital DUT as a stimulus signal.

As mentioned above, the digital interface signal is configured under the control of the DIO panel.

The Digital Generator and the Analog Generator (discussed above) are similar in appearance and function.

The Analyzer



After input conditioning, audio from the analog or the digital inputs can be routed to the ATS-2 Analyzer. Because the Analyzer uses DSP techniques for measurement and analysis, the audio must be in the digital domain. The audio from the digital input can be applied directly to the

Analyzer without need of conversion; the analog inputs, as we have seen, are converted to the digital domain by high-performance ADCs.

Click **Panels > Analyzer** or the **Analyzer** button on the Panels toolbar to open the Analyzer panel.

Real-Time and Batch Mode Measurements

Many of the ATS meters and instruments display their results in real time; that is, their displays update so quickly that moment-to-moment variations can be observed on a continuous basis. There is some variation in just how quick real-time measurements actually are; most of the ATS meters have variable detector rates, and the DIO interface monitors update at approximately 4 times per second. Within certain ranges, however, real-time measurements provide immediate results.

Other ATS instruments must first acquire a sample of the signal to be analyzed, and then perform DSP calculations on the data before display. These are called batch mode measurements, since the data is acquired and processed in discrete “batches.” In batch mode there is always an initial acquisition, after which the data is in memory and different analyses can be performed.

Analyzer instruments which use FFT techniques, including the Spectrum Analyzer, the Digital Interface Analyzer and the Multitone Audio Analyzer, are all batch mode instruments.

The Analyzer Instruments

Figure 11.
ATS Analyzer instrument selection.

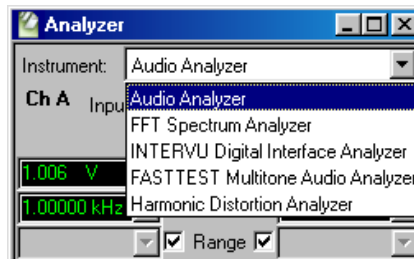

The Analyzer panel provides access to several specialized analysis tools called *instruments*. Selecting an Analyzer instrument loads a specific measurement program into the Analyzer DSPs. Each Analyzer instrument changes the appearance of the Analyzer panel, bringing its own set of input, setting, reading and other parameter choices.

The Analyzer instruments are discussed individually in subsequent chapters. They are:

- The Audio Analyzer, Chapter 10.

- The Spectrum Analyzer, Chapter 11.
- The Digital Interface Analyzer, Chapter 12.
- The Multitone Analyzer, Chapter 13.
- The Harmonic Distortion Analyzer, Chapter 14.

These five chapters discuss every function, control and display available on each Analyzer instrument panel in detail. If you are new to ATS-2, you might want to start with the Quick Guides in *Getting Started with ATS-2*, which will introduce you to the Analyzer instrument features.

Sweeps and Graphs



The Analog Generator, the Digital Generator, the Analyzer and other ATS functions can be controlled from the Sweep Panel, which orchestrates sets of measurements and provides the means to collect, graph, edit, constrain and modify analysis data.



See Chapter 15 for information on using sweeps, Chapter 16 for graphing, Chapter 18 to learn about limits and Chapter 19 for performing computations on test results.

Chapter 6

The Analog Input Panel

The Analog Input panel selects and configures audio signals that are applied to ATS-2's analog inputs, and sets the sample rate and bandwidth of the analog-to-digital converters (ADCs) that prepare the signals for analysis. See Chapter 5, **Signal Analysis**, and **Audio Analyzer Signal Inputs**, page 125.

Click **Panels > Analog Input** or the **Analog Input** button on the Panels toolbar to open the Analog Input panel.



Figure 12.
The ATS Analog Input panel.

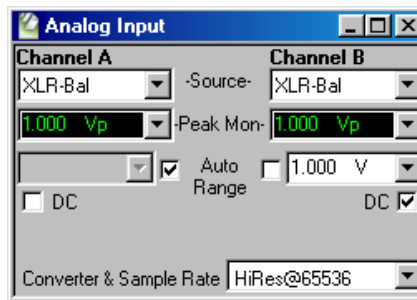

With the exception of the **Converter and Sample Rate** choices, the two analog input channels can be configured independently, with Channel A settings and readings to the left of the panel and Channel B to the right.

Source

Select the analog input source for each channel from the drop-down list. The choices are:

- **XLR-Bal**

This selection attaches the input channel to the balanced XLR input connection.

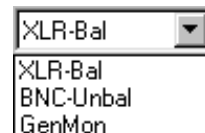

- **BNC-Unbal**

This selection attaches the input channel to the unbalanced BNC input connection.

- **GenMon**

This selects the generator monitor path, which bypasses the external analog inputs and instead attaches the input channel to the Analog Generator output via an internal connection.

See Chapter 4, **Signal Inputs and Outputs**, for more details concerning the physical and electrical characteristics of the analog input connections.

Input Termination Option

Figure 13.
The ATS Analog Input panel, shown with the 600Ω impedance option.

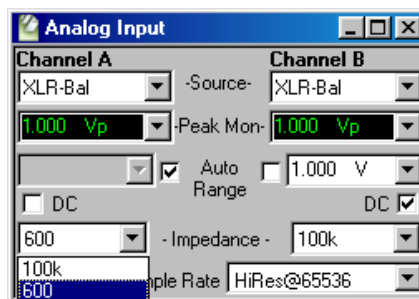

In the standard or European impedance configurations, the input load at each of the analog inputs is fixed at a high impedance, greater than 100 kΩ.

If you have ordered your ATS-2 with the 600 Ω impedance option ATS2-600Z, an additional field will be displayed on the Analog Input panel as shown in Figure 13.

With this option installed you have the choice terminating the input in a load of either **100 kΩ** or **600 Ω**. This termination choice affects both the balanced and unbalanced inputs.

Peak Monitors

Beneath the **Source** selection fields are two peak-reading monitors, one for each input channel. These monitors read the peak voltage of the analog inputs, to confirm signal presence and to aid you in setting the input ranging, if necessary.

Input Ranging

Practical devices have an optimum amplitude operating range in which they exhibit their best performance. This is true for amplifiers, for measurement instruments and for the ADC circuits used in ATS-2 domain conversion. ATS-2 uses selectable attenuators and gain amplifiers to bring a wide range of input signals to the optimum amplitude for the measurement detectors.

ATS-2 gives you the choice of automatic ranging (or *autoranging*) or manually setting a fixed maximum range.

Analog input ranging is controlled from the Analog Input panel. If you are using the **Audio Analyzer** instrument, additional Analyzer ranging controls are available on that instrument, as explained on page 129.

Autoranging

ATS-2 should normally be operated with automatic ranging, indicated by a check mark in each the appropriate **Auto Range** check boxes. This provides operation with no possibility of clipping due to high-amplitude signals.

Click the **Auto Range** check box to defeat autoranging. The range setting field for that meter and channel will become active, and you can enter a fixed maximum range for that input.

Fixed Range

Using a fixed range produces faster measurements, which can be important when speed is at a premium, as within a repetitive routine in an automated testing macro. However, you must know the probable range of the signal and set a maximum above the highest expected level.

Manual range selection is also preferred when using signals which vary quickly, such as tone bursts or program material such as voice or music. Automatic ranging will constantly switch levels when a complex, wide-range signal is applied. This may make it difficult to adjust a device for minimum distortion or noise, for example.

DC Coupling

ATS-2's analyzer circuitry can be DC-coupled from the front-panel connectors to the input of the ADC circuits. With DC coupling enabled, DSP acquisition of analog signals is extended down to DC.

DC coupling also provides a superior common-mode rejection ratio (CMRR) at low frequencies, which is normally limited by the inevitable small mismatch in the values of the coupling capacitors that serve to block the DC.

You can choose to pass the DC component of either analog input signal by checking the **DC** checkbox for either channel.

- If the checkbox is checked, DC coupling is enabled for that channel.
- If the checkbox is unchecked, a capacitor is inserted into the circuit and the DC component is blocked for that channel.

Converter and Sample Rate Selection

All signal analysis within ATS-2 is performed in the digital domain, and analog input signals must be converted using analog-to-digital converters (ADCs). In ATS-2, these are normally 24-bit high-resolution ADCs. You can choose one of two sampling rate references for the high-resolution ADCs from the **Converter & Sample Rate** drop-down list:

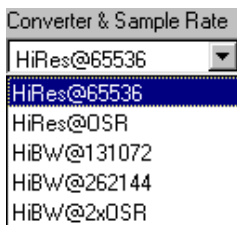

- **HiRes@65536 Hz.** This is the best choice for most audio testing. The high-resolution converters offer better noise and distortion characteristics than the optional high-bandwidth converters, and when the sampling rate is set to 65,536 Hz the high-frequency response of the analog inputs extends to 30 kHz.
- **HiRes@OSR.** This setting uses the high-resolution ADCs, but the value of the sampling rate is taken from the **Output Sampling Rate (OSR)** setting on the Digital Input/Output (DIO) panel. Some tests, such as multitone analysis, require that the digital signal applied to the DSP be synchronous with the **OSR**, and this selection provides that synchronization. At the maximum **OSR** of 108 kHz, the high-frequency response of the analog inputs extends to 50 kHz. See Chapter 7, **The Digital I/O Panel**.

ATS-2 can be ordered with the Performance Upgrade Option installed, which includes an additional pair of converters, the 16-bit high-bandwidth ADCs. These converters offer considerably higher sampling rates and available signal bandwidths, at the trade-off of less resolution. The standard 24-bit converters provide 10 dB to 15 dB better residual distortion.

If the high-bandwidth ADCs are installed, three more choices will be available on the drop-down list:

- **HiBW@131072 Hz.** When set at a sampling rate of 131,072 Hz, the frequency response of the analog inputs extends to 60 kHz.

- **HiBW@262144 Hz.** At this sampling rate setting of 262,144 Hz, the frequency response of the analog inputs is extended to 120 kHz.
- **HiBW@2xOSR.** This setting uses the high-bandwidth ADCs, but the value of the sampling rate is taken from the **Output Sampling Rate (OSR)** setting on the Digital Input/Output (DIO) panel. Some tests, such as DSP multitone analysis, require that the digital signal applied to the DSP be synchronous with the **OSR**, and this selection provides that synchronization with the high-bandwidth ADCs. See Chapter 7, **The Digital I/O Panel**.

Chapter 7

The Digital I/O Panel

This chapter discusses the Digital I/O panel (also called the Digital Input/Output panel or simply the DIO panel). The DIO panel serves as the hub for all digital signal input and output configuration. Additionally, a number of interface signal parameters can be monitored or changed on the DIO panel and on the linked Status Bits panel.

See Chapter 2 for an explanation of the characteristics of digital audio signal, including the serial digital interface signal and the embedded digital audio it carries. The digital input and output hardware connections are discussed in Chapter 4.

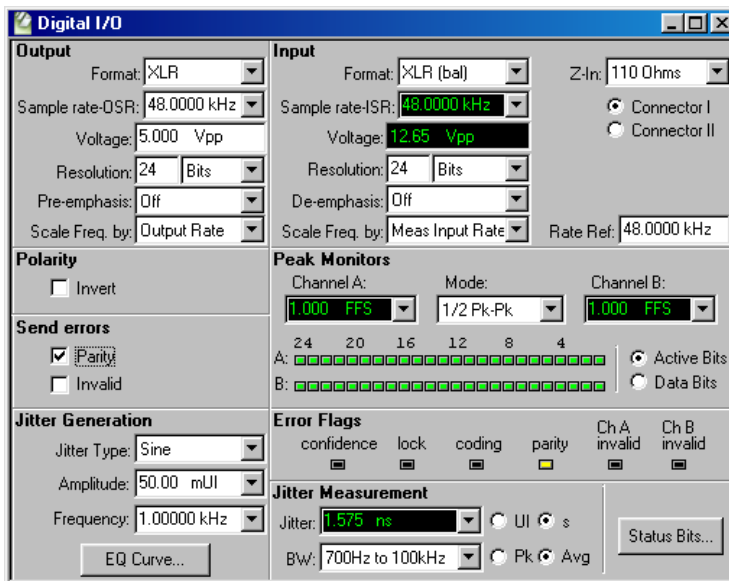
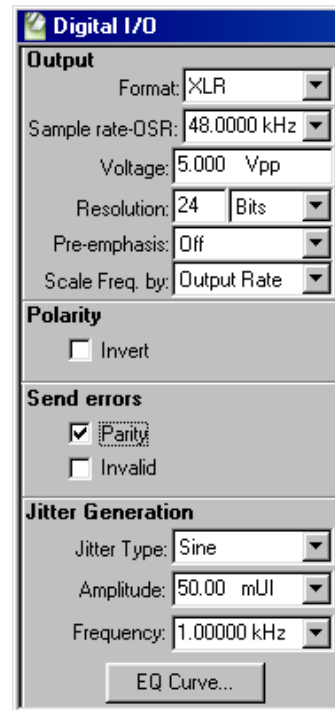

Figure 14. The Digital Input/Output (DIO) panel.

On the left of the DIO panel is the **Output** section, which includes configuration settings and a number of output signal impairment selections. The rest of the panel is the **Input** section, which includes input configuration and monitoring. A button near the bottom of the panel accesses the Status Bits panel.

The DIO Output Section

Figure 15. The DIO Output Section.



The routing and configuration of the digital interface output signal are set in the **Output** section of the DIO panel. Some settings which modify the embedded audio, such as **μ -Law** and **Pre-emphasis**, show up in this area of the panel as well.

The controls in the bottom half of the panel enable you to impair the digital output in several ways. An impaired digital interface signal can be useful in testing proper operation of interface signal receivers.

Format

Figure 16. The DIO Output Format Selections.

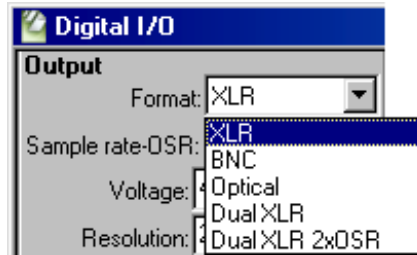

The first setting field is **Format**. Select the serial digital interface output format and connector(s) from the list.

- **XLR**
This is the balanced digital output. The signal voltage maximum is 5.10 V_{pp}, typical of the AES3 professional standard.
- **BNC**
This is the unbalanced digital output. The signal voltage maximum is 1.275 V_{pp}, typical of the AES3id professional standard and twice the voltage of the IEC60958-3 consumer standard.
- **Optical**
This is the Toslink® output.
- **Dual XLR**
These balanced digital outputs (I and II) are used in conjunction with each other, as explained in the **Dual Connector Mode** sidebar below. In this mode the **Sample rate - OSR** field sets the overall data rate, so the rate per output is 1/2 OSR.
- **Dual XLR 2xOSR**
Similar to Dual XLR, with this difference: the **Sample rate - OSR** field sets the data rate per connector, so the overall data rate is 2 × OSR.

All the digital outputs are always active. Signal voltage levels at the balanced and unbalance outputs are related by a 4:1 ratio; both will change when either is adjusted.

Dual Connector Mode

Typically the alternate data subframes in the AES3 signal carry the left and right audio channels. In the Dual XLR mode, each AES3 interface signal carries a monaural signal whose sub-frame rate is double the frame rate. Two connections (I and II) are required for 2-channel audio. Normally, Connector I carries the “A” or left audio channel and Connector II carries the “B” or right audio channel.

Output Sample Rate-OSR

Figure 17. The DIO Sample rate-OSR and Voltage selections.

The image shows a control panel with two fields. The top field is labeled 'Sample rate-OSR:' and contains a text input with '48.0000 kHz' and a small downward-pointing arrow on the right. The bottom field is labeled 'Voltage:' and contains a text input with '5.100 Vpp'.

The **Sample rate-OSR** field (labeled **Rate** on the small form of the DIO panel) allows you to set a value for the output sample rate (or **OSR**). The default **OSR** is 48 kHz. Simply click on the field and enter a new rate from the keyboard. The **OSR** may be set in the range between 28.8 kHz to 108 kHz; in **Dual XLR** mode the range is 57.6 kHz to 216 kHz. A drop-down list allows you to specify the units of measurement for the **OSR**.

The output sample rate set here, the **OSR**, is available on the Analog Input panel as a sample rate choice for the input ADCs. **OSR** also shows up on the Analog Generator panel as a sample rate selection for the DACs used in arbitrary waveform conversion and as the **Pass Thru** sample rate. **OSR** is also available as an embedded frequency scaling factor selection in the **Scale Freq. by** field in both the **Output** and **Input** sections of the DIO panel, where it is called **Output Rate**.

*When using the Dual Connector modes, ADCs or DACs using **OSR** as a sample rate selection are clocked by the connector rate (the cable rate). Frequency scaling is always by the overall rate.*

The output rate may be swept as part of a test by selecting **Dio** as the instrument and **Output Sample Rate** at **Source 1** or **Source 2** on the Sweep panel. See Chapter 15 for more information about sweeps.

Voltage

See Figure 17 for reference.

The **Voltage** field displays the output amplitude of the serial digital interface signal. Serial digital interface signal voltage is measured in volts, peak-to-peak (Vpp).

The signal voltage maximum for the **XLR** connector setting is 5.10 Vpp, typical of the AES3 professional standard; voltage maximum for the **BNC** connector setting is 1.275 Vpp, typical of the AES3id professional standard and twice the voltage of the IEC60958-3 consumer standard.

The voltage of the interface signal can be varied to simulate cable attenuation and test the performance of an interface receiver. Type in the **Voltage** field to enter a new interface voltage.

The XLR and BNC digital outputs are calibrated with the assumption that the signal is terminated in the proper impedance (110 Ω for the balanced output; 75 Ω for the unbalanced). If the signal isn't properly terminated the actual output voltage will be different from the voltage specified in the DIO panel.

The output voltage may be swept as part of a test by selecting **Dio** as the instrument and **Output Voltage** at **Source 1** or **Source 2** on the Sweep panel.

Output Resolution

Figure 18. The DIO Resolution selections.

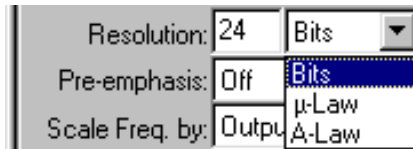

The **Resolution** field shows the output resolution or word width. You can set the resolution to any integer value from 8 bits to 24 bits by typing in the value and pressing the **Enter** key.

Internal to ATS-2, the digital signal is generated at a word length greater than 24 bits. When a word length is selected in the **Resolution** field, dither is added at the appropriate amplitude for that length and the signal is truncated to the specified value.

The output resolution is independent of the input resolution.

The output resolution may be swept as part of a test by selecting **Dio** as the instrument and **Output Resolution** at **Source 1** or **Source 2** on the Sweep panel.

μ-Law and A-law Compression

See Figure 18 for reference.

The field to the right of the **Resolution** field allows selection of **μ-Law** or **A-law** compression. This selection overrides the normal, uncompressed word width selected in the left **Resolution** field, which is grayed out under these conditions.

Choose **μ-Law** or **A-law** to enable the compression, or **Bits** to return to normal, linear PCM resolutions.

*The Digital Generator outputs a 14-bit or 13-bit signal when the **Resolution** is set to **μ-Law** or **A-Law**. Dither, if enabled, is properly scaled to these word lengths.*

See the sidebar on μ -Law and A-law below for more information on these companding techniques.

μ -Law and A-Law

The International Telecommunication Union (ITU) specifies in its standard G.711 two similar approaches for reducing the bit rate in digital voice telephony. Called μ -Law and A-Law, these techniques have been widely used in digital telecommunications for a number of years.

μ -Law and A-Law are known as companders, converting 14-bit linear PCM samples (μ -Law) or 13-bit linear PCM samples (A-Law) to an 8-bit pseudo floating-point representation via compression at the encoder and expansion at the decoder.

ATS-2 can both transmit and receive μ -Law and A-Law encoded digital signals through the AES3, IEC60958-3 and optical inputs and outputs.

Preemphasis

Figure 19. The DIO Preemphasis selections.

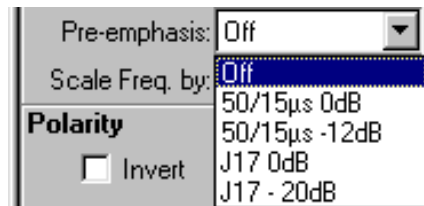

The embedded audio of the digital output signal may be transmitted without preemphasis, as is normal, or preemphasized according to one of two different functions. Preemphasis is rarely used.

The consumer format has only one defined preemphasis condition, the 50/15 μ s Compact Disc preemphasis. The professional format adds the CCITT J17 preemphasis.

Either preemphasis function may be selected at normal gain, or with a headroom allowance of -12 dB (50/15 μ s) or -20 dB (J17) if there is a concern that high-level test signals would exceed clipping (digital full scale) after preemphasis has been applied.

Matching deemphasis and gain selections are available in the **Deemphasis** field of the **Input** section of the DIO panel to provide overall unity gain and flat response.

Scale Freq. by

Figure 20. The DIO Scale Freq. by selections

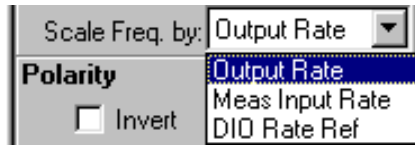

For a digital audio signal of a given sample rate, the embedded audio will be shifted in frequency when the same data is transmitted at a different sample rate. The audio frequency will change by the ratio of the two sample rates.

For example, a 1 kHz audio signal generated in DSP at a 48 kHz sample rate would be converted to a 666.67 Hz signal if transmitted at a 32 kHz sample rate.

ATS-2 offers the capability to scale the embedded frequency relative to the interface output or input sample rates.

In the output **Scale Freq. by** field you can select one of three sample rate choices as a reference by which to scale the embedded frequency of the digital output signal. The choices are:

- **Output Rate**, which is the rate set in the **Sample Rate-OSR** field above.
- **Meas Input Rate**, which is the measured input sample rate displayed on the Input side of the DIO panel.
- **DIO Rate Ref**, which is a reference value you can enter on the Input side of the DIO.

Polarity

Figure 21. The DIO Polarity selection.

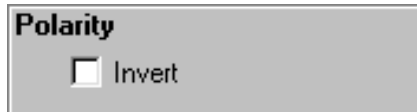

The polarity of the serial digital interface bitstream output can be reversed by checking the **Invert** checkbox. Properly-designed AES3 receivers should function correctly with either polarity of input bitstream.

Send Errors

Four bits are sent at the end of each frame of AES3/IEC60958 data: the Validity bit, the User bit, the Channel Status bit and the Parity bit. See Ap-

pendix B for more information about Status Bits and the AES3/IEC60958 interface.

ATS displays and sets the Status bits on the Status Bits panel, page 70. User bits are not displayed or set in ATS.

The states of the output Validity bit and the Parity bit can be changed on the DIO panel.

Figure 22. The DIO Send Errors selections.

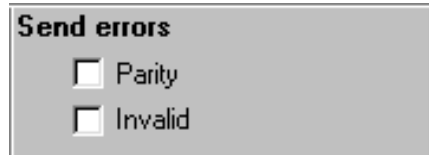

Changing the Parity bit

This bit will normally be high or low to maintain even parity within the frame. Setting a parity error by checking the **Parity** checkbox will invert the state of the Parity bit (bit 31), giving each frame odd parity. AES3 requires that parity be even, and the DUT should respond to odd parity as if data is corrupt.

Sending a Validity bit

The Validity bit (bit 28) will normally be low, indicating valid linear PCM audio. Checking the **Invalid** checkbox will set the Validity bit high, indicating invalid (non-audio or non-linear-PCM) data.

Jitter Generation

In a digital interface data stream, jitter is a variation in time of the pulse transitions from an ideal clock timing. ATS-2 can add sinusoidal jitter to the serial interface bitstream.

Figure 23. The DIO Jitter Generation selections.

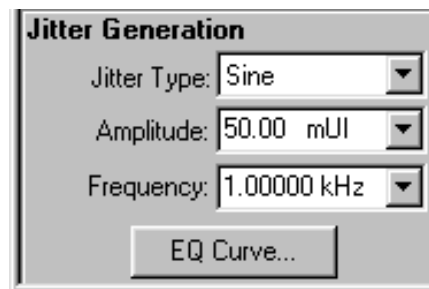

Jitter Type

- **Off**
Off disables jitter generation.
- **Sine**
Sine modulates the interface transition times with sinusoidal jitter. The amplitude and frequency of the sinewave are set in the fields below.
- **EQ Sine**
EQ Sine adds sinusoidal jitter in the same way as the previous choice, but attaches an EQ file to the sinewave. This causes the output jitter amplitude to vary as a function of jitter frequency, corresponding to the values in the EQ file selected. Use the **EQ Curve** browser to attach the file.

Amplitude

Enter the amplitude of the jitter in this field. The units available are **UI** (unit intervals), **dBUI** (decibels referred to 1.00 UI) and **s** (seconds, typically **ns** or nanoseconds). Jitter amplitudes are calibrated in terms of the peak value of a sinewave.

It may seem unusual to measure amplitude in units of time, but jitter is a variation in time. High levels of jitter produce large time displacements.

The unit interval is defined as the *shortest nominal time interval in the coding scheme*. Since an AES3 signal has 64 bits per frame and the bi-phase coding of the interface nominally doubles this rate, there are 128 UI per AES3 frame.

The UI is useful because it scales with the interface data rate. In the case of a 48 kHz sample rate and an AES3 frame as described above:

$$1 \text{ UI} = \frac{1}{(128 \times 48000/\text{s})} = 163 \text{ ns;}$$

or, with a 44.1 kHz sample rate:

$$1 \text{ UI} = \frac{1}{(128 \times 44100/\text{s})} = 177 \text{ ns.}$$

Jitter amplitude may be swept as part of a test by selecting **Dio** as the instrument and **Jitter Ampl** at **Source 1** or **Source 2** on the Sweep panel.

Frequency

Enter the frequency of the jitter sinewave in this field.

Jitter frequency may be swept as part of a test by selecting **Dio** as the instrument and **Jitter Freq** at **Source 1** or **Source 2** on the Sweep panel.

EQ Curve

The jitter sinewave generator can be equalized in the same way that the ATS-2 signal generators can.

Click the **EQ Curve...** button to select an EQ file to attach to the jitter generator. See **Specifying the EQ Curve** on page 88 for general information on using EQ files with generated signals.

The DIO Input Section

Figure 24. The DIO Input Section.

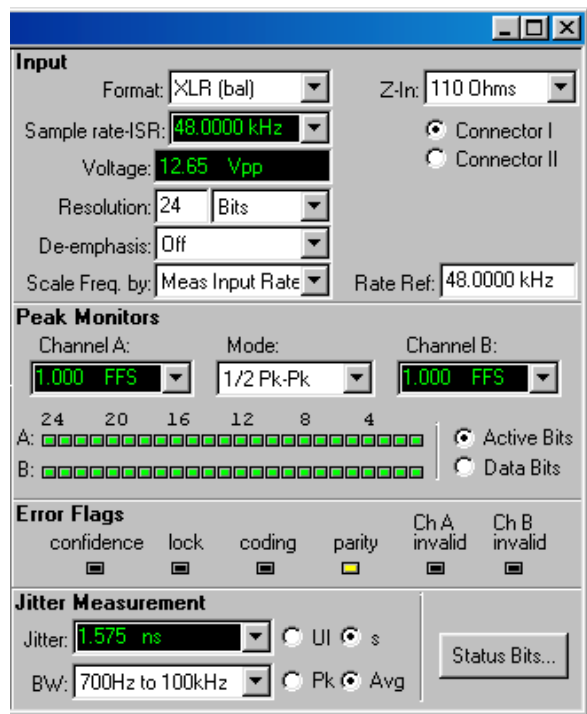

The routing and configuration of the digital interface input signal are set in the **Input** section of the DIO panel.

At the top area of the panel, meters display the measured input sample rate (**ISR**) and the interface bitstream voltage level. Some settings which affect the reception of the embedded audio, such as **Resolution** and **De-emphasis**, show up in this area of the panel as well.

The middle area of the panel contains data monitors, embedded audio peak level meters and interface error flag indicators.

At the bottom of the panel are jitter measurement displays and settings, and a button to open the Status Bits panel.

Format

Figure 25. The DIO Input Format Selections.

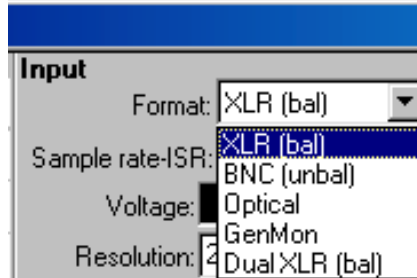

The first setting field is **Format**. Select the serial digital interface input format and connector(s) from the list.

- **XLR (bal)**
This is the balanced digital input. When the impedance at **Z-In** is set to $110\ \Omega$, this input satisfies the electrical aspects of the AES3 professional standard.
- **BNC (unbal)**
This is the unbalanced digital input. When the impedance at **Z-In** is set to $75\ \Omega$, this input satisfies the electrical aspects of the AES3id professional standard; with impedance at **HiZ**, this input satisfies the IEC60958-3 consumer standard.
- **Optical**
This is the Toslink® optical input.
- **GenMon**
This selects the generator monitor path, which bypasses the external digital input connector and instead attaches the digital input to the Digital Generator output via an internal connection.
- **Dual XLR (bal)**
These balanced digital inputs (I and II) are used in conjunction with each other, as explained in the **Dual Connector Mode** sidebar on page 53.

Input Impedance

Figure 26. The DIO Input Impedance / Connector I / Connector II selections.

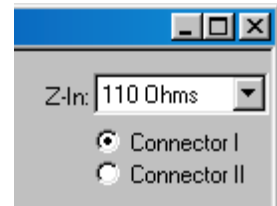

To the right of the Format selection field is the **Z-In** field, which allows you to choose the input impedance for the digital input. The impedance choices are different for the balanced and unbalanced inputs.

- **110 Ω** is the low-impedance selection for the balanced input, which satisfies electrical aspects of the AES3 professional standard.
- **75 Ω** is the low-impedance selection for the unbalanced input, which satisfies the AES3id professional standard.
- **HiZ** is the high-impedance selection, which when used with the unbalanced input satisfies the IEC60958-3 consumer standard. **HiZ** can also be used as a bridging input when ATS-2 is connected in parallel with an external device input, with the external device providing the termination.

Single and Dual Connector Input Bitstream Selection

See Figure 26.

Single-Connector Mode

When **XLR** is selected in the **Format** field, the **Connector I / Connector II** buttons allow you to choose either of the two balanced digital inputs for audio and interface measurements.

Dual-Connector Mode

When **Dual XLR** is selected in the **Format** field, the **Connector I** and **Connector II** selections allow you to choose either of the two balanced digital inputs for interface measurements. The DIO panel input sample rate (**ISR**) and **Voltage** displays, the **Jitter Measurement** reading and all Digital Interface Analyzer measurements of the digital interface characteristics are of the bitstream selected by the **Connector I** or **Connector II** buttons.

With **Dual XLR** selected, however, the **Connector I** and **Connector II** selections have no effect on the selection of the *embedded audio*. In dual-connector mode, the selected Analyzer instrument (**Audio Analyzer**,

Spectrum Analyzer, Multitone Audio Analyzer, or Harmonic Distortion Analyzer) always analyzes left channel audio from **Connector I** and right channel audio from **Connector II**.

See Chapter 12, **The Digital Interface Analyzer**.

Input Sample Rate-ISR

Figure 27. The DIO **Sample rate-ISR** and **Voltage** selections.



The **Sample rate-ISR** field (labeled **Rate** on the small form of the DIO panel) displays the measured input sample rate (or **ISR**) at the **Connector I** digital input. In dual-connector mode, the **ISR** displays the sample rate of either the **Connector I** or **Connector II** inputs, as selected. Input sample rates from 28.8 kHz to 108 kHz are accepted. A drop-down list allows you to specify the units of measurement for the **ISR**.

The input sample rate displayed here, the **ISR**, is also available as an embedded frequency scaling factor selection in the **Scale Freq. by** field in both the **Output** and **Input** sections of the DIO panel, where it is called the **Meas Input Rate**.

The input sample rate may be used to control a sweep as part of a test by selecting **Dio** as the instrument and selecting the reading **Input Sample Rate** at **Source 1** or **Source 2** on the Sweep panel.

Voltage

See Figure 27 for reference.

The **Voltage** field displays the input amplitude of the serial digital interface signal. Serial digital interface signal voltage is measured in volts, peak-to-peak (Vpp). The Voltage field does not display when **Optical** is selected as the digital input **Format**.

The serial interface input voltage may be used to control a sweep as part of a test by selecting **Dio** as the instrument and selecting the reading **Input Voltage** at **Source 1** or **Source 2** on the Sweep panel.

Input Resolution

Figure 28. The DIO Resolution selections.

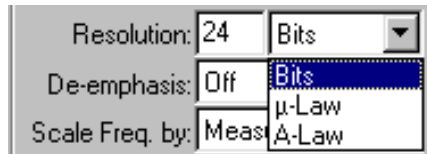

The actual resolution or word width of the incoming digital signal is shown in the **Active Bits** display below.

The **Resolution** field shows the resolution or word width to be enforced on the incoming digital signal. You can set the resolution to any integer value from 8 bits to 24 bits by typing in the value and pressing the **Enter** key.

If the value entered in the **Resolution** field matches or exceeds the resolution of the incoming digital signal, the signal is passed on unchanged. If the value entered is lower than the incoming resolution, the signal is truncated at the LSB.

The value of quantization noise and distortion of the audio of digital input signals measured by the Analyzer instruments will be affected by the **Input Resolution** setting.

If the input signal being measured is using the Aux bits for another signal, the **Input Resolution** must be set to 20 bits or fewer to strip off the Aux signal before measurement by one of the Analyzer instruments. See Chapter 2 for an explanation of Aux bits in the digital audio word.

The input resolution is independent of the output resolution.

The input resolution may be swept as part of a test by selecting **Dio** as the instrument and **Input Resolution** at **Source 1** or **Source 2** on the Sweep panel.

μ-Law and A-law Expansion

See Figure 28 for reference.

The right field of the **Resolution** section allows selection of **μ-Law** or **A-law** expansion. This selection overrides the word width selected in the left **Resolution** field, which is grayed out under these conditions.

Choose **μ-Law** or **A-law** to enable the expansion, or **Bits** to return to normal, linear PCM resolutions.

See the sidebar on **μ-Law** and **A-law** on page 56 for more information on these companding techniques.

Deemphasis

Figure 29. The DIO **Deemphasis** selections

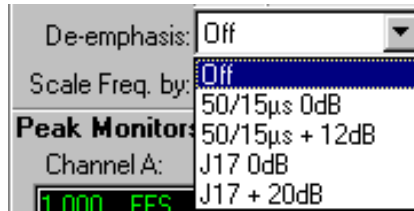

A digital signal transmitted with preemphasis must be deemphasized on reception. Since preemphasis is rarely used, deemphasis is rarely needed.

See **Preemphasis** on page 56.

To properly deemphasize a signal you must select deemphasis curves and gain (50/15 µs Compact Disc at 0 dB or +12 dB; or CCITT J17 at 0 dB or +20 dB) that are complementary to the preemphasis conditions, to provide overall unity gain and flat response.

The deemphasis (and gain, if any) is implemented after the **Channel A** and **Channel B Peak Monitors**, so the monitor readings will not be affected as deemphasis is turned on and off.

Scale Freq. by

Figure 30. The DIO **Scale Freq. by** selections

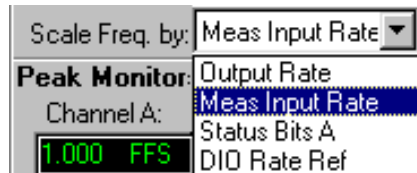

ATS-2 must normalize the frequency of an incoming digital audio signal to a local sample rate before display, whether the signal is to be displayed numerically or as a frequency component on an FFT graph. Depending on the application, there are several sources of sample rate which may be appropriate for normalization.

ATS offers the capability to select one of four sample rate choices as a reference by which to scale the embedded frequency of the digital input signal. The choices are:

- **Output Rate**, which is the rate set in the **Sample Rate - OSR** field.
- **Meas Input Rate**, which is the measured input sample rate (**ISR**).

- **Status Bits A**, which is the value of the sample frequency encoded into the received Channel A status bits.
- **DIO Rate Ref**, which is a reference value you can enter on the Input side of the DIO.

Generally, **Meas Input Rate** will be used as the scaling source so that audio signal frequency measurements follow any changes in sample rate from the source.

If the actual measured value is unstable, you may enter the nominal incoming sample rate in the **Rate Ref** field and select **DIO Rate Ref** for stable audio frequency scaling.

The **Output Rate** selection can be used to measure the frequency- shifting effects of digital processors and sample rate converters.

The **Status Bits** selection refers frequency measurements to the nominal, standard sample rate (if in fact the sample rate is actually encoded into the status bits) and will be independent of any moment-to- moment variations in the actual received sample rate.

Rate Ref

Figure 31. The DIO Rate Ref entry field.



Rate Ref: 48.0000 kHz

Rate Ref is a reference field. A sample rate entered here can be selected as a reference for digital input or output frequency scaling. The acceptable range for **Rate Ref** is 28.8 kHz to 216.00 kHz.

Peak Monitors

Figure 32. The DIO Peak Monitors.

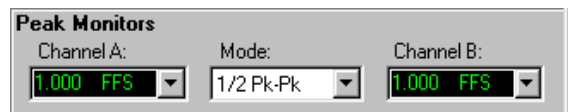

The DIO panel provides the capability to view the peak levels of the embedded audio signals. These meters indicate the digital input levels prior to the application of deemphasis, if used.

The **Mode** field between the numeric display fields permits selection among four types of responses:

- **Pos. Peak**
displays the greatest positive value during each measurement

interval, which is approximately 1/4 second for all peak monitor response modes.

- **Neg. Peak**
displays the greatest negative value during each measurement interval.
- **Abs. Peak**
displays the absolute value of the greatest positive-going or negative-going value during each measurement interval. **Abs. Peak** is always expressed as a positive number.
- **1/2 Pk-Pk**
displays the value that is one-half the peak-to-peak range measured during the measurement interval.

Data Bit Indicators

Figure 33. The DIO Data Bit Indicators.



The Data Bit indicators show a bit-by-bit view of the embedded data in the digital signal audio word for each subframe. The two subframes correspond to Channel A and Channel B.

The bits are labeled from the left from the most significant bit (MSB, or bit 24 of the word) to the least significant bit (LSB, or bit 1 of the word) on the right. The Data Bit indicators examine the signal in intervals of approximately 1/4 second.

The Data Bit indicators have two modes, selectable by the option buttons to the right of the indicator rows.

When **Data Bits** is selected, the indicators display green for a bit that is at data 1 at the moment of measurement, and black for a bit that is at data 0.

When **Active Bits** is selected, the indicators display green for a bit that has changed state during the measurement period, and black for a bit that has not.

Error Indicators

Figure 34. The DIO Error Indicators.

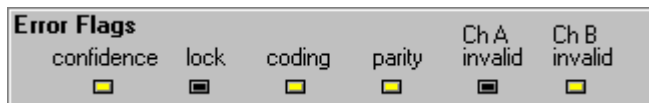

The ATS DIO panel contains four error indicators for characteristics of the serial digital signal. The indicators are labeled **Confidence**, **Lock**, **Coding**, and **Parity**. Proper operation is indicated when none of the indicators is lighted. When an indicator lights, it shows that some characteristic of the digital input signal is marginal or unacceptable.

Both the Digital Interface Analyzer and the Main Trigger panel can select a **Parity**, **Coding**, **Lock**, or **Confidence** error flag to act as a trigger.

Two more indicators, labeled **Ch A invalid** and **Ch B invalid**, light when the Validity bit (bit 28, the V bit) of that subframe is asserted.

The Confidence Indicator

The **Confidence** indicator lights when the ratio between the amplitude of the 3 UI-long pulse and the following 1 UI-long pulse in a subframe preamble becomes large enough to cause an increasing probability of errors when “slicing” the input signal into logic high and low values. This large ratio occurs when the transmission bandwidth has been reduced to marginal or unacceptable values.

The Lock Indicator

The **Lock** indicator lights when the digital input phase-locked loop is unable to lock to the incoming signal.

The Coding Indicator

The **Coding** indicator shows a deviation from proper bi-phase coding in the input serial bitstream. Since the subframe preambles deliberately deviate from the bi-phase coding rules in order to provide a unique synchronization signal, preambles are excluded from the function of the **Coding** indicators.

The Parity Bit Indicator

The **Parity** bit indicator indicates a parity error within a subframe. Correct parity is determined by comparing the parity bit (bit 31, the “P” bit) with the sum of the remaining 31 bits in each subframe. Any one bit error or odd number of bit errors introduced in transmission will cause a **Parity** error indication.

A deliberate parity bit error (the “P” bit set high) can be transmitted from the ATS-2 digital output by checking **Parity** in the DIO Output **Send Errors** section.

Unfortunately, even numbers of bit errors within a subframe cannot be detected by the parity technique.

The Validity Bit Indicators

Two additional indicators show whether the Channel A and B validity bits (bit 28, the “V” bit) are asserted or not.

A validity bit is associated with each subframe. Exactly how (or if) the validity bit is set depends upon the design of the particular digital device being measured. For example, a DAT machine may set its “V” bit to *invalid* (“V” bit set high) when the tape is not playing and to *valid* (set low) when the tape is moving.

The “V” bit transmitted by ATS-2 can be set high (both Channel A and B are set together) by checking **Invalid** in the DIO Output **Send Errors** section.

Jitter Measurement

Figure 35. DIO
Jitter Measurement.

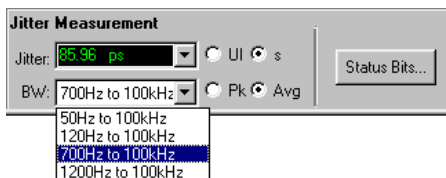

The jitter of the digital interface signal is shown in the DIO Panel **Jitter Measurement** display. This measurement is made from the error signal of the AES receiver input phase lock loop, and is sensitive to jitter of the total signal, including transitions in both the preamble and the data sections of the frames. Jitter measurements may be displayed in units of **UI** (unit intervals) or **s** (seconds, typically **ns** or nanoseconds).

You can choose one of two detector responses, **Pk** (peak) and **Avg** (average) for the jitter meter. Both detectors are calibrated in terms of the peak value of a sine wave.

The averaging detector is typically used for making frequency response plots of the jitter signal, while the peak detector should be used for characterizing actual interface jitter. Peak jitter measurements will almost always give a higher number than average, depending upon the crest factor of the jitter waveform.

Jitter is often dominated by low-frequency noise, so the value of jitter measured is likely to be a strong function of the bandwidth of the measurement. Four bandwidth selections may be selected for jitter measurements:

- 50 Hz–100 kHz
- 120 Hz–100 kHz
- 700 Hz–100 kHz, and

- 1200 Hz–100 kHz.

Jitter may be plotted on a graph as a function of some swept parameter such as time or transmitted jitter amplitude; choose **Dio** as the Sweep **Data** instrument and **Interface Jitter** as the parameter.

Using the **Spectrum Analyzer** instrument you can select the **Jitter** signal and display either the jitter waveform or an FFT spectrum analysis of the jitter signal. See **Spectrum Analyzer Signal Inputs** on page 156.

Jitter may also be measured according to an entirely different technique by the Digital Interface Analyzer instrument, described in Chapter 12.

The Status Bits panel

Channel status bits are administrative or “housekeeping” data carried in the AES3 and IEC60958 serial digital interfaces. Each subframe has one “C” (Channel Status) bit, bit number 30. The bits are gathered and arranged into channel status blocks of 192 bits, marked off by the block start code which occurs in the interface preamble at intervals of 192 subframes.

Bit 0 in the status block identifies the format as professional or consumer. The information in the status blocks differs, for the most part, between the two formats. See page 386 for more information about Channel Status.

The ATS Status Bits panel gives you the ability to both view received status bits and to set transmit status bits to any condition. Choose **Panels > Status Bits** to open the panel, or click the **Status Bits** button on the Toolbar or on the DIO panel.

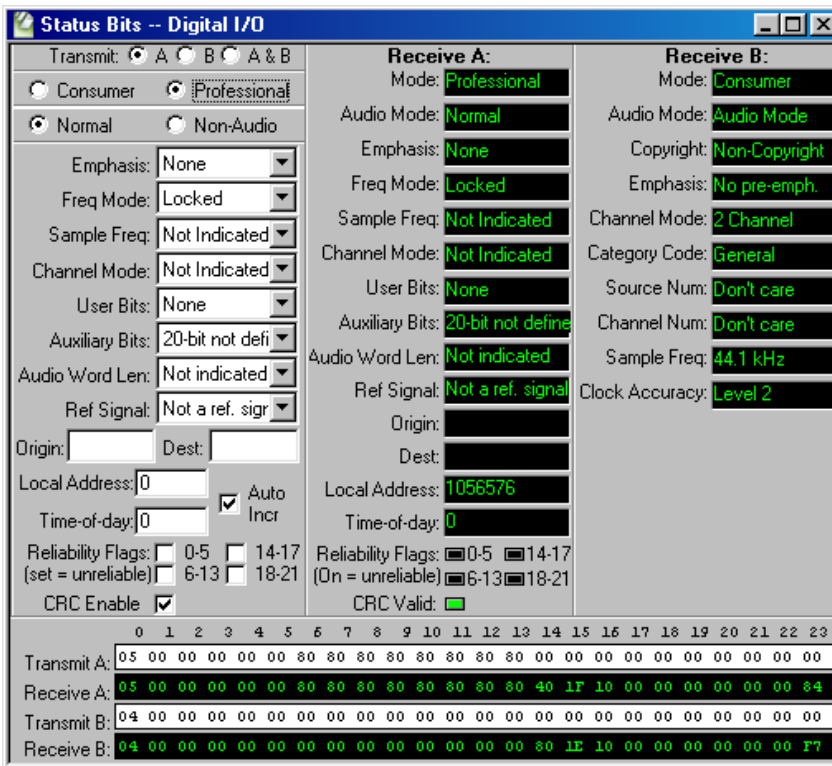

Figure 36. The Status Bits panel.

Transmit Status Bits

The left side of the status bits panel has a number of fields to select status bit conditions for the transmitted serial interface signal appearing at the ATS-2 digital output.

The first three option buttons select whether the settings you make operate on Channel A, Channel B or both.

To select the format, click **Consumer** or **Professional**. Since the consumer and professional formats vary greatly in the status bit fields available, the choice of format will bring an entirely different set of options to the panel. We will look at the Consumer format options first.

Consumer Format Status Bits

Figure 37. Transmitting Consumer Format Status Bits.



The screenshot shows a software panel titled "Status Bits -- Digital I/O". It contains several rows of radio buttons and a section of drop-down menus. The radio buttons are arranged in pairs for each row, with the first option in each pair selected. The rows are: "Transmit:" with options A, B, and A & B; "Consumer" vs "Professional"; "Audio Mode" vs "Data Mode"; "Copyright" vs "Non-Copyrigh"; "No pre-emph" vs "50/15µs"; and "2 Channel" vs "4 Channel". Below these is a section with five drop-down menus: "Category Code:" (General), "Source Num:" (Don't care), "Channel Num:" (Don't care), "Sample Freq:" (44.1 kHz), and "Clock Accuracy:" (Level 2).

Transmit:	<input type="radio"/> A	<input type="radio"/> B	<input checked="" type="radio"/> A & B
	<input checked="" type="radio"/> Consumer	<input type="radio"/> Professional	
	<input checked="" type="radio"/> Audio Mode	<input type="radio"/> Data Mode	
	<input checked="" type="radio"/> Copyright	<input type="radio"/> Non-Copyrigh	
	<input checked="" type="radio"/> No pre-emph	<input type="radio"/> 50/15µs	
	<input checked="" type="radio"/> 2 Channel	<input type="radio"/> 4 Channel	
Category Code:	General ▼		
Source Num:	Don't care ▼		
Channel Num:	Don't care ▼		
Sample Freq:	44.1 kHz ▼		
Clock Accuracy:	Level 2 ▼		

With the option buttons and drop-down lists shown here, you can set any of the consumer format status bit conditions. See page 386 for more information about Channel Status and for detailed tables of the consumer format status bit fields and interpretations.

Professional Format Status Bits

Figure 38. Transmitting Professional Format Status Bits.

The screenshot shows the 'Status Bits -- Digital I/O' panel. At the top, there are radio buttons for 'Transmit' with options A, B, and A & B. Below that, there are radio buttons for 'Consumer' and 'Professional' (selected). Underneath, there are radio buttons for 'Normal' (selected) and 'Non-Audio'. The panel contains several drop-down menus: 'Emphasis' (Not Indicated), 'Freq Mode' (Locked), 'Sample Freq' (Not Indicated), 'Channel Mode' (Not Indicated), 'User Bits' (None), 'Auxiliary Bits' (20-bit undefin), 'Audio Wordlen' (Not indicated), and 'Ref Signal' (Not a ref. sigr). There are also text input fields for 'Origin' and 'Dest'. Below these are 'Local Address' (0) and 'Time-of-day' (0) fields, with an 'Auto Incr' checkbox checked. At the bottom, there are 'Reliability Flags' (0-5, 6-13, 14-17, 18-21) checkboxes, with 'CRC Enable' checked.

With the option buttons and drop-down lists shown here, you can set any of the professional format status bit conditions. See page 386 for more information about Channel Status and for detailed tables of the professional format status bit fields and interpretations.

Local Address and Time of Day entry

If the **Auto Incr** box is checked, ATS automatically enters a continuously increasing count, in audio samples, in both the **Local Address** and the **Time of Day** fields. The count begins at the moment the professional format is selected, or at the moment the **Auto Incr** box is checked, whichever occurs later.

If the **Auto Incr** box is not checked, you may enter a fixed number into either field.

CRC entry

The AES3 professional standard defines status byte 23 as a cyclic redundancy code (CRC) byte, to assist the receiver in detecting errors in the first 23 bytes (bytes 0–22). If the **CRC Enable** box is checked, ATS automatically computes a CRC byte based on the data in bytes 0–22, and transmits that byte as status byte 23. This is normal operation.

If the **CRC Enable** box is not checked, the CRC is not computed and you may enter arbitrary values into byte 23 of the Hex Transmit field to test the error detection capability of the receiver in the DUT.

Receive Status Bits

Figure 39. Display of Received Status Bits, Channel A showing Professional Format and Channel B showing Consumer Format.

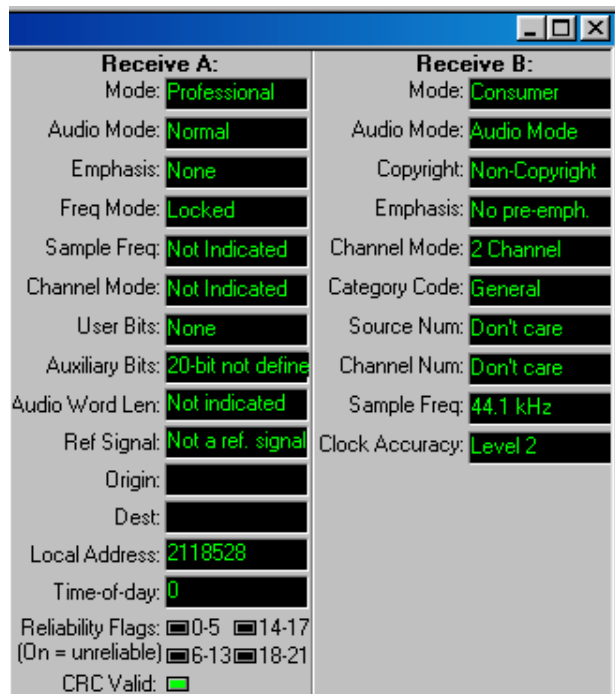

The right side of the Status Bits panel displays the conditions read in the incoming interface data. This display is updated approximately four times per second. If there are no incoming data, the panel display defaults to the consumer format fields.

The professional format **Reliability Flags** display OFF (black) for normal received data and ON (green) for unreliable data. The **CRC Valid** flag is ON (green) for valid received CRC, and OFF (black) for invalid CRC.

Hex Control and Display

	0	1	2	3	4	5	6	7	8	9	10	11	12	13	14	15	16	17	18	19	20	21	22	23
Transmit A:	05	00	00	00	00	00	80	80	80	80	80	80	80	80	00	00	00	00	00	00	00	00	00	00
Receive A:	05	00	00	00	00	00	80	80	80	80	80	80	80	80	53	20	00	00	00	00	00	00	00	1A
Transmit B:	04	00	00	00	00	00	00	00	00	00	00	00	00	00	00	00	00	00	00	00	00	00	00	00
Receive B:	04	00	00	00	00	00	00	00	00	00	00	00	00	00	C0	52	20	00	00	00	00	00	00	7D

Figure 40. Hexadecimal Display and Control of Status Bits.

At the bottom of the Status Bits panel are hexadecimal status bit setting fields and displays. The hex codes for the channel status conditions are detailed in the AES3 and IEC60958 standards.

The hex fields set (white with black text) and display (black with green text) the same status conditions as are set and displayed above in the high-level English display. A setting made in a high-level transmit field will be echoed in the corresponding hex transmit field; a setting made in a hex transmit field will be echoed in the corresponding high-level transmit field.

To make an entry in a hex field, click the cursor in the field desired and move back and forth with the arrow keys. Overtyping the hex code or codes shown with the new value, and press the **Enter** key to make the change.

Dual Connector Mode and Status Bits

In single-connector mode Channel A and Channel B status bits (corresponding to the A and B subframes in the data stream) can be set and read.

In dual-connector mode, the Channel A labels on the Status Bits panel refer to the Connector I signal, and the Channel B labels refer to the Connector II signal.

In this mode the received status bits are read from subframe A on each of the two signals; subframe B status bits are ignored. Transmitted status bits, in dual-connector mode, are identical in both subframes.

Chapter 8

The Analog Generator

Test Signal Generation in ATS-2

Most audio testing requires that a stimulus signal be applied to the device under test (DUT). At its simplest, the stimulus may be just a mid-frequency sinewave at a nominal level; a step up would be a sweep of frequencies, or the combination of tones used for intermodulation distortion (IMD) testing. An example of a very complex stimulus is a *multitone burst*, which has many precisely generated frequencies at a range of specific levels.

The signal generation systems in ATS-2 use digital signal processing (DSP) techniques to create a wide range of stimulus signals.

Two Audio Signal Generators

ATS-2 has two independent audio signal generating systems: the Analog Generator, which provides signal to the Analog Outputs, and the Digital Generator, which is the source of the audio embedded in the Digital Output signal.

The Analog and Digital generators both produce their signals in DSP, and they are similar in operation and in the settings available on their respective instrument panels. The two generators are completely independent and can generate different waveforms simultaneously.

See Chapter 9 for more information on the Digital Generator.

Signals for Analog Measurements

The Analog Generator creates audio signals in DSP that are converted to the analog domain with two high precision digital-to-analog converters (DACs). The resulting analog signals are then buffered and conditioned

and routed to the analog output circuitry. The outputs are configured by settings on the Analog Generator panel.

The Analog Generator Panel



Open the Analog Generator panel by choosing **Panels > Analog Generator**, by clicking the **Analog Generator** button on the Panel toolbar or by the keyboard shortcut **Ctrl+G**. Like most ATS panels, the Analog Generator can be viewed in two sizes. Double-click the panel Title Bar to change sizes.

Figure 41. The Analog Generator Panel.

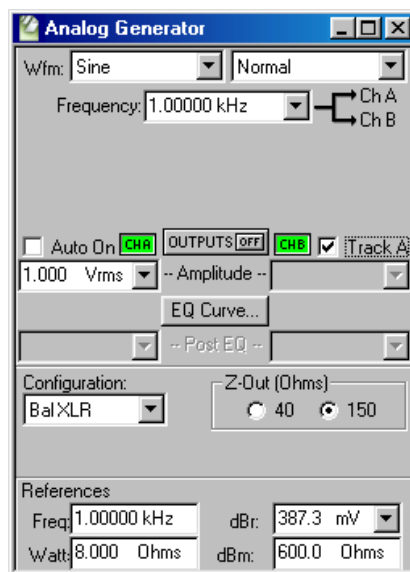

The Analog Generator panel is divided into three areas:

- The upper area, which provides fields for choosing waveforms, setting amplitude and attaching EQ curves;
- the center area, which provides controls for bandwidth and output configuration, and
- the lower area, which provides fields to set references.

We will first look at general topics of setting frequency and amplitude and turning the generator **ON** and **OFF**; then we will examine the many waveform selections available in detail; then we will look at configuring the analog outputs and setting the analog references.

Frequency Units

Figure 42. Setting the Analog Generator Frequency

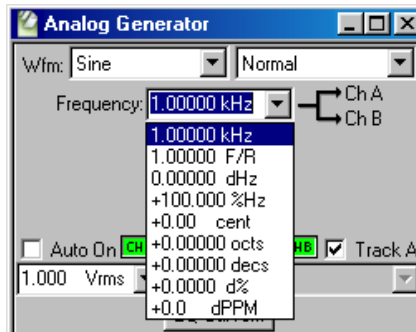

Frequency may be expressed in absolute units (hertz) and in a variety of units relative to the value entered in the **Reference: Freq** field. See **Analog Generator References** on page 95 and **Frequency Units** on page 372.

Changing units does not change the frequency of the generator. The existing frequency will simply be re-stated in the new units. Also, the value displayed after pressing **Enter** may differ slightly from the value you typed in, since ATS will step to the nearest frequency increment.

Output On/Off and Channel Selection

Figure 43. Analog Generator On / Off.



The Analog Generator signal outputs are toggled **ON** and **OFF** by the **OUTPUTS** button. Additionally, each channel output can be switched individually on and off by the **CH A** and **CH B** buttons on either side of the **OUTPUTS** button. Both the main **OUTPUTS** button and an individual channel button must be switched on to route signal to the analog output circuitry.

Auto On

If the **Auto On** checkbox is checked, the Analog Generator is automatically switched **ON** when a sweep starts, and **OFF** when the sweep stops.

This is useful for power amplifier or loudspeaker testing. With the generator set to **OFF** and **Auto On** enabled, signal will only be applied to the DUT while the sweep is actually running.

See Chapter 15 for more information on sweeps. Also see **Pre-Sweep Delay** on page 269 for a discussion of avoiding transients in the **Auto On** mode.

Amplitude Control and Units

Figure 44. Setting the Analog Generator Amplitude.

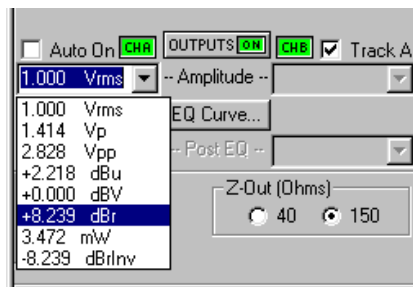

If the **Track A** checkbox is checked, the amplitudes of both Channel A and Channel B are set by the Channel A **Amplitude** setting.

If the **Track A** checkbox is not checked, the amplitudes of the two Analog Generator channels can be controlled individually. Type a value in the **Amplitude** setting field for either Channel A or Channel B and press **Enter**.

You can choose an amplitude unit of measurement from the units drop-down list, shown in Figure 44. Changing a unit of measurement will not change the audio amplitude, only the expression of the value. See **Analog Amplitude Units**, page 372.

The value displayed after pressing **Enter** may differ slightly from the value you typed in, since ATS will step to the nearest amplitude increment.

The Analog Generator will not permit an output amplitude entry greater than 16 Vrms (22.62 Vp) when configured for a balanced output; or 8 Vrms (11.31 Vp) when configured for an unbalanced output. If you enter a value greater than these maximum values, or a combination of values (in **EQ Sine** mode, for example) which results in a greater value, an error message is displayed.

Waveforms other than a sine wave are calibrated in *peak equivalent sine wave* terms; that is, the **Amplitude** setting field is calibrated to show the rms value of a sine wave with same peak value as the waveform selected. Selecting a square wave with an **Amplitude** value of 1.000 Vrms on the Analog Generator panel, for example, produces a 1.414 Vp square wave signal.

Choosing an Analog Generator Waveform

The Analog Generator offers a wide choice of test waveforms selectable from the primary and secondary waveform lists.

Figure 45. Analog Generator Primary Waveform Selections.

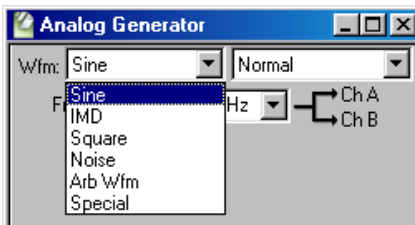

These list selections are, for the most part, sorted by the shape of the waveform, such as sinewave, squarewave, noise, and so on. Most waveform choices have an associated secondary list, from which you make your final waveform selection.

This chapter organizes the waveforms by shape. The variations available on the secondary lists are described under each section.

Sine waveforms

This section describes the sine waveforms available to the Analog Generator, which cover the frequency range from 2 Hz to 60 kHz. See page 94 for information on setting the Analog Generator bandwidth. Sinewave frequency can be set in hertz or in a variety of relative units; see **Frequency Units**, page 372.

Figure 46. Analog Generator Sine Waveform Selections.

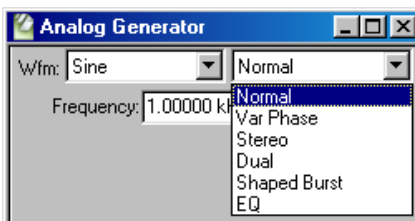

Wfm: Sine: Normal

Figure 47. Analog Generator Sine Normal.

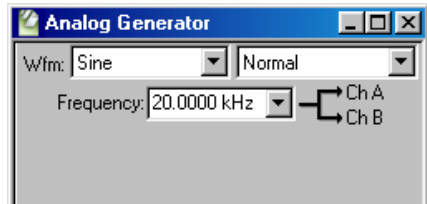

The normal sine waveform is the standard waveform for most audio testing, and is the default generator waveform.

Wfm: Sine: Var Phase

Figure 48. Analog Generator Sine Var Phase.

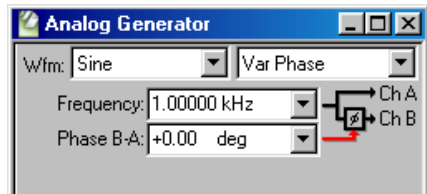

This choice produces the selected frequency at both Channel A and B outputs, but the phase of the Channel B output is variable from -180° to $+179.99^\circ$ with respect to the Channel A output, as controlled by the **Phase B-A** field.

A positive value entered in the **Phase B-A** field will cause the Channel B output to lead the Channel A output. A negative value entered in the **Phase B-A** field will cause the Channel B output to lag the Channel A output. See the illustration below:

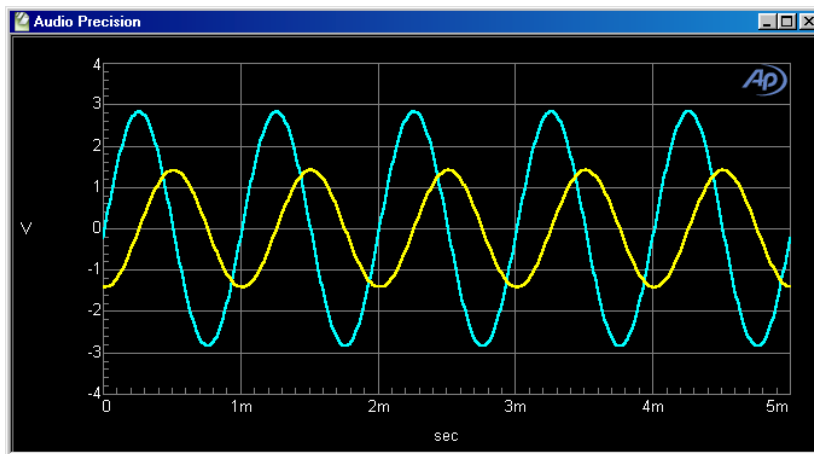
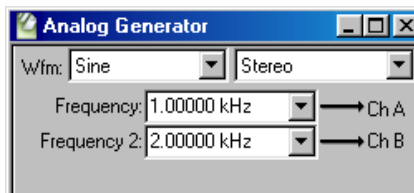

Figure 49. **Sine: Var Phase**, triggered on Channel A (the larger waveform). **-90.00 deg** has been entered in **Phase B-A** field, causing B (the smaller waveform) to lag A.

Wfm: Sine: Stereo

Figure 50. Analog Generator Sine Stereo.



This waveform selection produces independent sinewaves on Channel A and Channel B. The **Frequency** field sets the frequency of the Channel A signal, and the **Frequency 2** field sets the frequency of the Channel B signal. Their amplitudes are independently set by the two **Amplitude** fields unless the **Track A** box is checked, in which case the amplitudes are equal and controlled by the Channel A **Amplitude** field.

Wfm: Sine: Dual

Figure 51. Analog Generator Sine Dual.

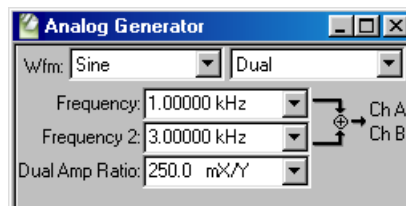

This selection produces two independent sinewaves which are summed to create a complex waveform. This complex waveform is sent to both channel outputs.

The **Frequency** and **Frequency 2** fields permit each component sinewave frequency to be set independently. The **Dual Ampl Ratio** field enables you to set the ratio by which the secondary (**Frequency 2**) sinewave component amplitude will be attenuated with respect to the amplitude of the primary (**Frequency**) sinewave component.

In **Sine: Dual**, the amplitude setting determines the sum of the amplitudes of the two components. A 1 V amplitude setting with a 25% ratio produces a waveform which is the sum of a 800 mV sinewave and a 200 mV sinewave.

The **Sine: Dual** signal is particularly useful as a calibration signal for harmonic distortion analyzers, where the **Frequency** signal at reference amplitude represents the fundamental signal. The secondary (**Frequency 2**) sinewave can be set to any desired harmonic of the primary (**Frequency**) “fundamental” sinewave, at an amplitude to represent any desired distortion level. For example, setting the primary (**Frequency**) at 1 kHz and the secondary (**Frequency 2**) at 3 kHz with a **Dual Amp** ratio of -40.0 dB (1%) produces a 1 kHz signal with third harmonic distortion of 1.0%.

Wfm: Sine: Shaped Burst

Figure 52. An example of a shaped burst.

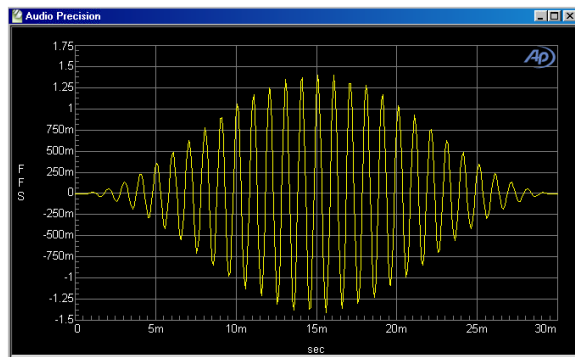

A tone burst is an audio signal (usually a sinewave) that is keyed on and off. Tone bursts are often used as stimulus signals, and can reveal characteristics of a DUT’s performance which are not observable with continuous tones.

The Analog Generator **Sine: Shaped Burst** signal is essentially identical to the Digital Generator **Sine: Shaped Burst** signal, and both are similar to the Digital Generator **Sine: Burst** signal.

For both generators, the **Sine: Shaped Burst** has a raised-cosine shaped envelope, creating a relatively narrow energy spectrum around the sinewave frequency. The Digital Generator **Sine: Burst** has a rectangular envelope with fast rise and fall times and consequently a wider spectrum of energy.

Figure 53. Analog Generator Sine: Shaped Burst panel.

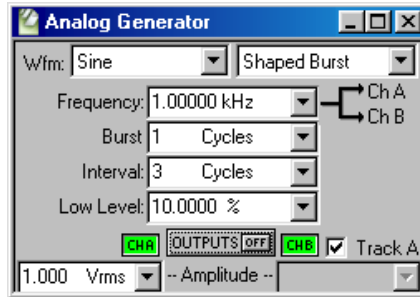

The frequency of the sinewave is set in the **Frequency** field. The **Amplitude** field sets the generator amplitude at the maximum burst ON level.

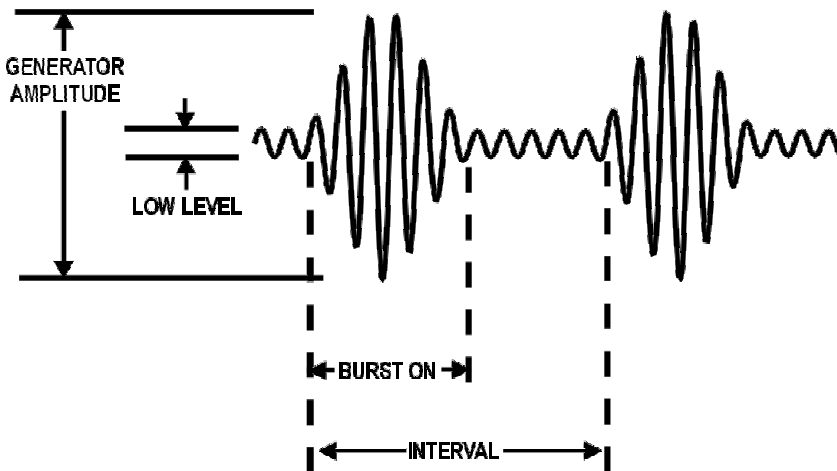

Figure 54. Tone burst definitions using a shaped burst as an example.

Refer to Figure 54 for definitions of the following settings:

■ **Burst**

Enter a value in the **Burst On** field to set the duration of the tone burst. The maximum **Burst On** duration is 65,535 cycles of the sine waveform, if **Interval** is set to its maximum; the minimum is 1 cycle. **Burst On** can be set in units of **Cycles** or **s B** (seconds, Burst). Only **Burst On** durations which are less than the **Interval** durations can be entered.

■ Interval

Enter a value in the **Interval** field to set the period between the onset of the tone burst and the onset of the next burst. The maximum **Interval** is 65,536 cycles of the sine waveform; the minimum is 2 cycles. **Interval** can be set in units of **Cycles** or **s B**.

Interval does not describe the time between the end of a burst and the beginning of the next, but the entire period from the beginning of one burst until the beginning of the next.

■ Low Level

When a tone burst is ON, the level of the sinewave in the burst is the same as the current **Amplitude** setting for the Analog Generator. When a tone burst is OFF, the low level is the ON level multiplied by the value set in the **Low Level** field. The OFF level is a ratio of the ON level, set here in units of **X/Y** ratio, **dB**, % (per cent), or **PPM**. See **Ratio Units**, page 378.

If **Low Level** is set to equal the burst high-level amplitude, no burst effect will occur and the output will be a continuous sinewave.

At large amplitude ratios, the amplitude resolution of **Low Level** becomes poorer. The display will show the actual available resolution steps, rather than the value entered.

Zero-Crossing

The beginning and ending of any tone burst are always at the positive-going zero-crossing points of the sinewave, which eliminates transients from the output.

Because of the zero-crossing nature of the tone bursts, only integer numbers of cycles can be entered as a **Burst On** or **Interval** setting; if you are using **s B** units, only time durations which represent multiples of the full period of a cycle of the selected sinewave can be entered as a **Burst On** or **Interval** setting.

Wfm: Sine: EQ

Figure 55. Analog Generator Sine EQ

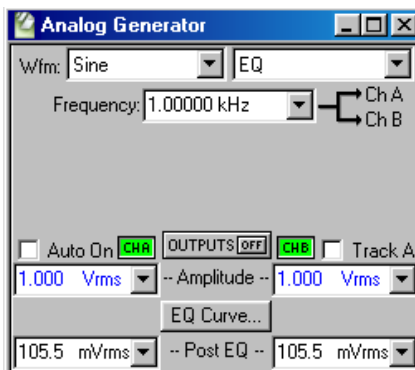

Generator Equalization

The **Sine: EQ** setting outputs a normal sinewave, with equalizing amplitude changes made in the generator level according to an attached EQ data file. This enables you to make a frequency sweep where the generator amplitude varies as instructed by the data in the attached file.

When you select **Sine: EQ** and attach an EQ file (see below), a new field call **Post EQ** appears on the Analog Generator panel. The **Post EQ** field displays the generator amplitude to be applied to the DUT, which is value entered in the **Amplitude** field corrected by the value (at that frequency) of the correction factor in the attached EQ file.

*When **Sine: EQ** is selected, the values in the **Amplitude** field are displayed in **blue** rather than **black**.*

To set the output amplitude, you can enter a value in either the **Amplitude** field or the **Post EQ** field, and the value in the other field will be properly adjusted according to the correction factor.

The Analog Generator will not permit an output amplitude entry greater than 16 Vrms (22.62 Vp) when configured for a balanced output, or 8 Vrms (11.31 Vp) when configured for an unbalanced output. If the value of the normal (pre-EQ) **Amplitude** field as modified by the equalization file would attempt to produce an amplitude greater than these maximum values, an error message is displayed.

If a frequency value outside the frequency range span of the EQ file is entered on the generator panel or occurs during a sweep, the **Post-EQ** amplitude will go to 0 V.

Specifying the EQ Curve

The EQ curve is specified by an AP data file (usually an EQ file, with the extension .atsq) which lists frequencies in **Column 1** and the corresponding amplitude changes in **Column 2** (or another column of your choice).

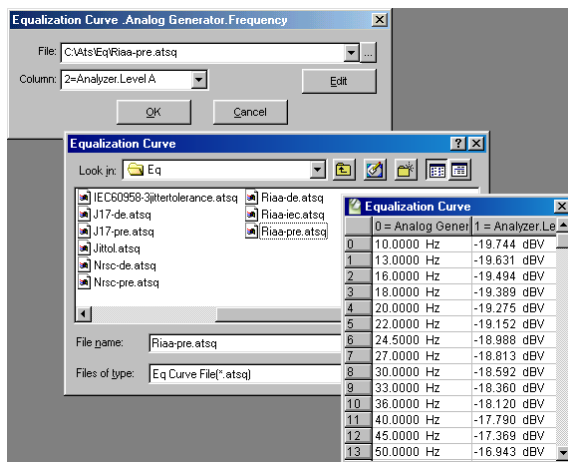

Figure 56. EQ file attachment and editing.

Click the **EQ Curve** button to open the Equalization Curve dialog box, then click the browser button to open the Equalization Curve file browser.

When you have selected an EQ file, it will be attached to the generator panel and the file name will appear in the Equalization Curve dialog box. The default amplitude data column is **Column 2**; you can choose another column from the drop-down list in the Equalization Curve dialog box.

To view or edit the EQ file, click the **Edit** button to open the Attached File Editor (see page 313).

You can create custom EQ curves by manually creating an ATS EQ file, or by using the current sweep data in memory and a Compute function to produce an appropriate EQ file. See Chapters 18 and 19 for more information on saving data files and modifying EQ data from a sweep using Compute functions.

Typical EQ Applications

The most common applications of generator equalization are to produce a nominally flat output from a device which contains a known equalization function. Typical examples would be U.S. FM and TV aural broadcast transmitters using 50 μ s and 75 μ s preemphasis curves.

By attaching an equalization curve to the ATS-2 generator that is the inverse of the nominal curve used in the device under test, the resulting measured output should be flat. Small variations from flatness will be a measurement of the accuracy of equalization in the device, since the .atsq curves provided are accurate to better than 0.01 dB and the specified generator flatness is of the same order.

Squarewave

Figure 57. Analog Generator Squarewave Waveform.

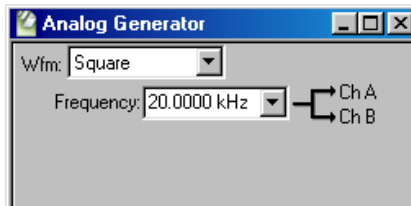

Wfm: Square

The frequency range for squarewaves is from 2 Hz to 20 kHz.

The squarewave amplitude is calibrated in peak equivalent sinewave terms. See **Amplitude Control and Units** on page 80.

Intermodulation Distortion (IMD)

Intermodulation distortion (IMD) testing requires a stimulus which is a combination of two waveforms, and a specific analysis technique to evaluate interaction of the waveforms within the DUT. ATS-2 provides two versions of the SMPTE/DIN standard IMD test signals.

IMD signal amplitude is set in the Analog Generator **Amplitude** field. The IMD composite waveform amplitude is calibrated in peak equivalent sinewave terms. See **Amplitude Control and Units** on page 80.

Figure 58. Analog Generator IMD Waveform Selections,

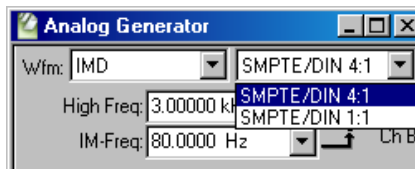

Wfm: IMD: SMPTE/DIN 4:1

This selection produces a signal which is the linear combination of two sinewaves. The first sinewave, set in the **IM-Freq** field, is a lower-frequency tone that can be assigned any frequency in the range of 40 Hz to

500 Hz. The frequency of the second sinewave, set in the **High Freq** field, can be anywhere in the range from 2 kHz to 60 kHz.

The low-frequency sinewave is linearly combined in 4:1 amplitude ratio with the high-frequency sinewave.

Wfm: IMD: SMPTE/DIN 1:1

This is the same as the **Wfm: IMD: SMPTE/DIN 4:1** selection, except that the amplitude ratio of the low-frequency sinewave to the high-frequency sinewave is 1:1.

Noise Waveform

Figure 59. Analog Generator Noise Waveform Selection.

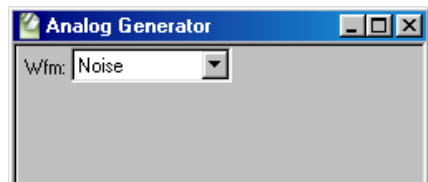

The ATS-2 Analog Generator offers a DSP-generated white noise signal.

The DSP-generated noise is pseudo-random and has a length of 2^{20} or 1,048,576 samples. The DAC sample rate is 131.072 kHz, which means that the noise pattern repeats about every 8 seconds. The noise has a zero mean, a crest factor of 1.73 and a rectangular probability distribution function. The spectrum of the noise is flat from just above 0 Hz to 60 kHz.

The noise waveform amplitude is calibrated in peak equivalent sinewave terms. See **Amplitude Control and Units** on page 80.

White Noise Characteristics

The spectral distribution of white noise is characterized by equal noise energy per hertz. This means that the spectral range between 100 Hz and 200 Hz will have the same energy as the range between 10,000 Hz and 10,100 Hz.

If analyzed by a constant-bandwidth spectrum analyzer such as a superheterodyne or FFT analyzer, white noise will show a flat energy characteristic versus frequency (up to the bandwidth limitation).

*Analysis of white noise with a constant-percentage-bandwidth (constant Q) filter such as in the Audio Analyzer **Bandpass** mode (or as in most real-time analyzers) will show a rising characteristic versus frequency, at the rate of 3 dB per octave.*

Arbitrary Waveforms

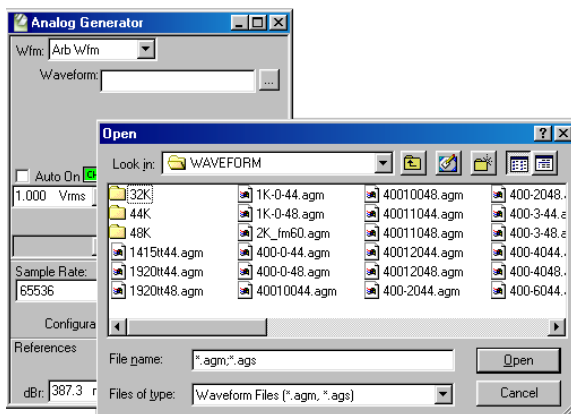

Figure 60. Loading an arbitrary waveform.

The generator arbitrary waveform function allows you to load a properly formatted digital waveform file into the ATS-2 DSP and route the waveform to the Analog Generator outputs.

Arbitrary waveform files provided with ATS-2 include single tones, tone combinations for IMD testing, multitone waveforms and calibration tones, and other useful waveforms.

Waveform files must be of the Audio Precision .agm (**G**enerator **M**ono) or .ags (**G**enerator **S**tereo) file types. You may also make custom arbitrary waveform files using a file creation utility provided with ATS-2 or with third-party applications such as MATLAB. See **Multitone Creation** on page 236.

Setting the DAC Sample Rate

To load a waveform file and then output the waveform so that the embedded audio tones are at the intended frequencies, the sample rate of the Analog Generator DACs must be set to the same sample rate that was used in creating the file.

If you use a sample rate different from the sample rate at which the file was created, the frequency of the audio tones embedded in the output signal will be shifted by the ratio of the two sample rates.

When **Arb Wfm** is selected, a **Sample Rate** field appears on the lower portion of the Analog Generator panel.

Figure 61. Selecting an Arbitrary Waveform Sample Rate.

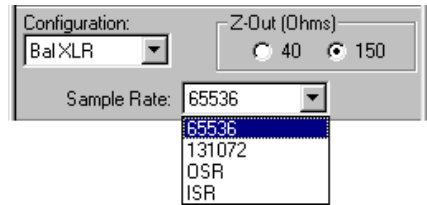

You can select from 4 sample rate choices for the DACs:

- **65536**, which is the lower fixed sample rate for the Analog Generator DACs.
- **131072**, the higher fixed sample rate.
- **OSR**, the **Output Sample Rate** set in the DIO panel. ATS-2 offers two methods of setting DAC sample rates using the **OSR** selection. Go to the first tab of the Configuration panel at **Utilities > Configuration** to set the method you prefer, as follows:
 - If the **Set sample rate when loading generator waveforms** checkbox is checked, ATS will automatically set the DIO **OSR** to the sample rate of the file being loaded.
 - If this checkbox is unchecked, you must manually enter the sample rate you desire in the **OSR** field on the DIO panel.
- **ISR**, the **Input Sample Rate** read from ATS-2's digital input and displayed on the DIO panel.

*The Arbitrary Waveform generation memory buffers of the Analog Generator and Digital Generator are shared. If both generators have **Arb Wfm** selected as the waveform, the same waveform file will be used for both and the same signal will be produced at both the analog and digital generator outputs.*

Special Waveforms

Figure 62. Analog Generator Special Waveform Selections

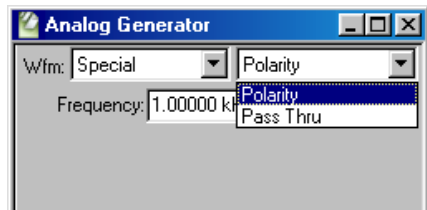

Wfm: Special: Polarity

Figure 63. Analog Generator Special Polarity

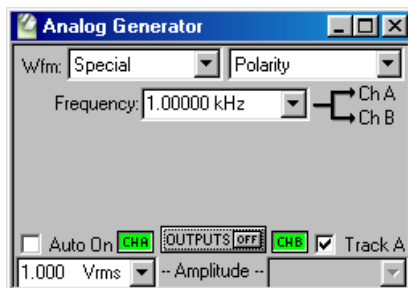

The polarity waveform is designed to be obviously asymmetrical, so that it is easily apparent if signal is inverted or not. The waveform is the sum of the fundamental tone set in the **Frequency** field and its second harmonic, in a fixed phase relationship.

When the output of the DUT is viewed using an oscilloscope or the ATS Spectrum Analyzer in the time-domain view, the signal will reveal whether or not there has been a polarity inversion in the DUT or in the signal interconnections.

The only setting available for the polarity waveform is **Frequency**.

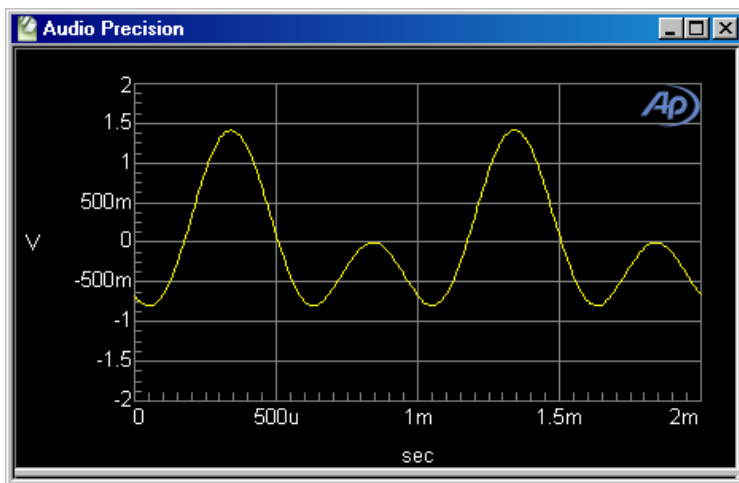

Figure 64. Polarity waveform, normal polarity shown.

Wfm: Special: Pass Thru

The **Special: Pass Thru** selection does not cause a waveform to be generated; instead, it converts the digital audio signal connected to the

rear panel **SYNC/REF IN** BNC connector to an analog signal and passes it through to the Analog Generator outputs.

This is a convenient way to convert a digital test signal (from a CD, for example) to an analog test signal. If the **REF IN** signal is stereo, the output signal will also be stereo.

In **Pass Thru** mode, the sample rate of the Analog Generator DACs is set to the ATS **Output Sample Rate (OSR)**, indicated by the **Sample Rate** field on the generator panel which shows **OSR** in this mode. The **OSR**, which is set on the DIO panel, has a range of 28.8 kHz to 108 kHz. The **REF IN** signal is sample rate converted to the **OSR**.

The **REF IN** signal sample rate must be between 28.8 kHz and 108 kHz. Additionally, the ratio of the **REF IN** sample rate to the **OSR** must fall in the range between 1:3 to 3:1; or, stated another way,

$$\frac{OSR}{3} \leq REF\ IN\ SR \leq OSR \times 3.$$

The sample rate converter is controlled by ATS to maintain the **REF IN** embedded audio at its original frequency. As a result, changing the **OSR** setting will not shift the audio frequency of the **REF IN** signal, but it will affect the signal's bandwidth. To avoid attenuation and distortion in **Special: Pass Thru**, the **REF IN** audio frequency must not exceed $0.47 \times OSR$.

The default setting of the **OSR** is 48 kHz. To preserve bandwidth, for most **Pass Thru** audio testing the **OSR** should not be set lower than 44.1 kHz.

The amplitude relationship between the **REF IN** signal and the Analog Generator output is such that a **REF IN** signal of 1.00 FS (0 dBFS) will result in a correctly calibrated analog output signal; that is, the signal will have peaks equal to those of a sinewave of the rms value set in the Analog Generator amplitude field.

Configuring the Analog Outputs

The analog output configuration is controlled from the Analog Generator panel. Both A and B outputs are configured together. The choices are

- **Bal XLR**, a balanced signal on the XLR male connectors (pin 2 high).
- **UnBal BNC/XLR**, an unbalanced signal available on both the BNC and the XLR male connectors (pin 2 high).
- **CMTST XLR**, a common-mode test signal on the XLR male connectors (both pins 2 and 3 high).

Figure 66. Analog Output Configuration, Balanced

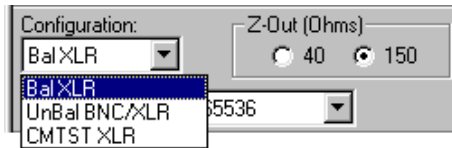

You can also choose one of two output impedances using the option buttons. These impedances are available for the balanced and common-mode configurations:

- if your ATS-2 was ordered with the standard output impedances, the choices are **40 Ω** and **150 Ω**;
- if your ATS-2 was ordered with the Euro impedance option, the choices are **40 Ω** and **200 Ω**;
- if your ATS-2 was ordered with the 600 Ω impedance option, the choices are **40 Ω** and **600 Ω**.

The impedances available for the unbalanced configuration are always **20 Ω** and **50 Ω**.

Figure 67. Analog Output, European impedance option.

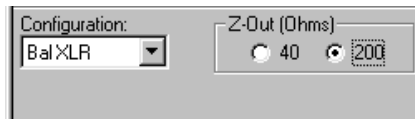
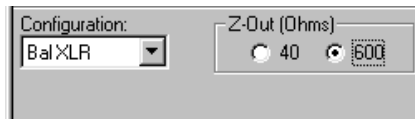

Figure 68. Analog Output Configuration, 600 Ω impedance option.



Do not “unbalance” the balanced outputs by connecting pin 2 or pin 3 of an XLR output connector to ground, as might be done with adapter cables. Connecting the ATS-2 balanced outputs to an unbalanced load will produce distorted waveforms. Use the unbalanced output connectors for an unbalanced load.

See Chapter 4 for more information about the ATS-2 Analog Outputs.

Analog Generator References

With the appropriate choice of units, amplitude and frequency settings in the Analog Generator can be made relative to reference values. These references are entered manually in the Analog Generator **References**

area. Freq and dBr references can also be entered “on the fly” from the current generator settings, as explained below.

Figure 69. Analog Generator References

References			
Freq:	1.00000 kHz	dBr:	387.3 mV
Watt:	8.000 Ohms	dBm:	600.0 Ohms

"dBr" Amplitude Reference

The dBr (which is shorthand for “decibels relative to a reference”) reference is an easy way to set a nominal level against which your settings or readings are made. Enter a reference value in the **References: dBr** field, or load it “on the fly” from the current generator amplitude setting using the menu command **Edit > Set Generator dBr Ref** or the keyboard shortcut **F3**.

You can set an Analog Generator **dBr** reference in **V**, **dBV** or **dBu** units.

Frequency Reference

The relative units of frequency for the Analog Generator are **F/R**, **dHz**, **%Hz**, **cent**, **octs**, **decs**, **d%**, and **dPPM**.

In a relative expression, the frequency setting or reading is expressed in relation to a second reference frequency. For Analog Generator relative frequency settings, this reference frequency is entered in hertz in the Analog Generator **References: Freq** field, or it can be entered “on the fly” from the current generator frequency setting with the menu command **Edit > Set Generator Freq Ref**, or with the keyboard shortcut **Ctrl+F3**.

Watts Reference

Because the watt is a unit of power, a voltage reading in **Watts** units will only have meaning if the circuit impedance is known.

To use watts levels, select **Watts** as the **Amplitude** unit of measurement, and then set the **Watts** impedance reference to the correct impedance value for your application. The default value is 8 Ω .

dBm Reference

Because the dBm is a unit of power (decibels relative to 1 mW), a voltage reading in **dBm** units will only have meaning if the circuit impedance is known.

To use dBm levels, select **dBm** as the **Amplitude** unit of measurement, and then set the **dBm** impedance reference to the correct impedance value for your application. The default value is **600 Ω**.

*dBm is rarely the correct choice of units for audio measurements. dBm units are often mistakenly chosen when dBu units should be used. See the sidebar **dBm versus dBu** on page 375.*

Chapter 9

The Digital Generator

Test Signal Generation in ATS-2

Most audio testing requires that a stimulus signal be applied to the device under test (DUT). At its simplest, the stimulus may be just a mid-frequency sinewave at a nominal level; a step up would be a sweep of frequencies, or the combination of tones used for intermodulation distortion (IMD) testing. An example of a very complex stimulus is a *multitone burst*, which has many precisely generated frequencies at a range of specific levels.

The signal generation systems in ATS-2 use digital signal processing (DSP) techniques to create a wide range of stimulus signals.

Two Audio Signal Generators

ATS-2 has two independent audio signal generating systems: the Analog Generator, which provides signal to the Analog Outputs, and the Digital Generator, which is the source of the audio embedded in the Digital Output signal.

The Analog and Digital generators both produce their signals in DSP, and they are similar in operation and in the settings available on their respective instrument panels. The two generators are completely independent and can generate different waveforms simultaneously.

See Chapter 8 for more information on the Analog Generator.

Signals for Digital Measurements

The Digital Generator creates audio signals in DSP that are then embedded in a *digital audio interface data stream*, such as described in the AES3 or IEC60958 standards. This interface signal is configured for output by set-

tings made in the Digital Input/Output (DIO) panel, which is discussed in detail in Chapter 7. See Appendix B for more information on the digital audio signal.

The Digital Generator Panel



Open the Digital Generator panel by choosing **Panels > Digital Generator**, by clicking the **Digital Generator** button on the Panel toolbar or by the keyboard shortcut **Ctrl+D**. Like most ATS panels, the Digital Generator can be viewed in two sizes. Double-click the panel Title Bar to change sizes.

Figure 70. The Digital Generator Panel.

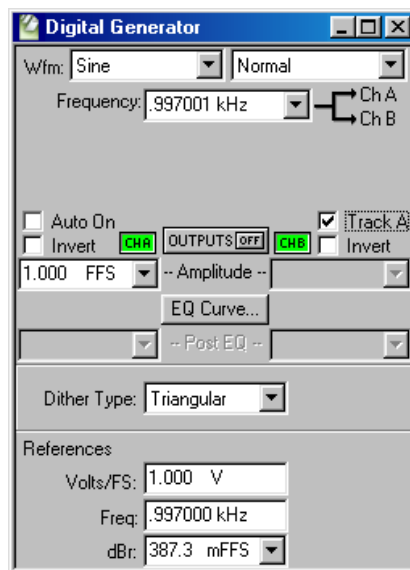

The Digital Generator panel is divided into three areas:

- The upper area, which provides fields for choosing waveforms, setting amplitude and attaching EQ curves;
- the center area, which offers control of dither, and
- the lower area, which provides fields to set references.

We will first look at general topics of setting frequency and amplitude and turning the generator **ON** and **OFF**; then we will examine the many waveform selections available in detail; last we will look at choosing the dither type and setting the digital references.

Frequency Units

Figure 71. Setting the Digital Generator Frequency.

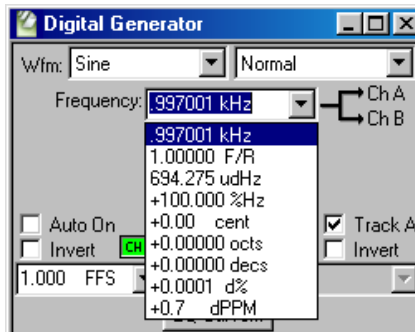

Frequency may be expressed in absolute units (hertz) and in a variety of units relative to the value entered in the **Reference: Freq** field. See **Digital Generator References** on page 122 and **Frequency Units** on page 372.

Changing units does not change the frequency of the generator. The existing frequency will simply be re-stated in the new units. Also, the value displayed after pressing **Enter** may differ slightly from the value you typed in, since ATS will step to the nearest frequency increment.

Output On/Off and Channel Selection

Figure 72. Digital Generator ON / OFF. Both channels and the Outputs are shown



The Digital Generator signal outputs are toggled **ON** and **OFF** by the **OUTPUTS** button. Additionally, each channel output can be switched individually on and off by the **CH A** and **CH B** buttons on either side of the **OUTPUTS** button. Both the main **OUTPUTS** button and an individual channel button must be switched on to route signal to the digital output circuitry.

Auto On

If the **Auto On** checkbox is checked, the Digital Generator is automatically switched **ON** when a sweep starts, and **OFF** when the sweep stops.

This is useful for power amplifier or loudspeaker testing. With the generator set to **OFF** and **Auto On** enabled, signal will only be applied to the DUT while the sweep is actually running.

See Chapter 15 for more information on sweeps. Also see **Pre-Sweep Delay** on page 269 for a discussion of avoiding transients in the **Auto On** mode.

Channel Invert

ATS-2 maintains correct absolute polarity throughout the system. You can invert the polarity of either audio channel by clicking the **Invert** checkbox for that channel. When neither or both **Invert** boxes are checked, both channels have the same polarity.

Polarity inversion of one channel with respect to the other can be used to create the stereo “difference” signal which modulates the subcarrier in some stereo multiplex systems.

Amplitude Control and Units

Figure 73. Setting the Digital Generator Amplitude.

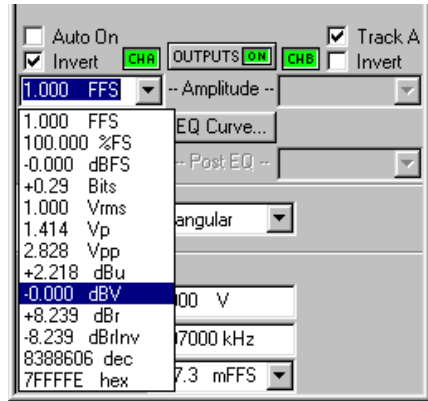

If the **Track A** checkbox is checked, the audio amplitude of both Channel A and Channel B are set by the Channel A **Amplitude** setting.

If the **Track A** checkbox is not checked, the audio amplitudes of the two Digital Generator channels can be controlled individually. Type a value in the **Amplitude** setting field for either Channel A or Channel B and press **Enter**.

You can choose an amplitude unit of measurement in either the analog or digital domains from the units drop-down list, shown in Figure 73. The ability to state a digital audio amplitude in analog terms makes it easy to work with the analog output values while testing a D-to-A converter, for example, when the full scale analog output of that converter is known. Enter the DUT voltage which corresponds to digital full scale in the **References: Volts/FS** field (see page 122).

Changing a unit of measurement will not change the audio amplitude, only the expression of the value. See **Digital Amplitude Units**, page 376, and **Analog Amplitude Units**, page 372.

The value displayed after pressing **Enter** may differ slightly from the value you typed in, since ATS will step to the nearest amplitude increment.

The Digital Generator will not permit an output amplitude entry greater than 1.000 FFS (0 dBFS). If you enter a value greater than 1.000 FFS or a combination of values (in **EQ Sine** or **Sine+Offset** modes, for example) which would result in a value greater than 1.000 FFS, an error message is displayed.

Waveforms other than a sinewave are calibrated in *peak equivalent sinewave* terms; that is, the **Amplitude** setting field is calibrated to show the rms value of a sinewave with same peak value as the waveform selected. Selecting a squarewave with an **Amplitude** value of 100.0 Vrms on the Digital Generator panel, for example, produces a 141.4 mVp squarewave signal.

Choosing a Digital Generator Waveform

The Digital Generator offers a wide choice of test waveforms selectable from the primary and secondary waveform lists.

Figure 74. Digital Generator Primary Waveform Selections.

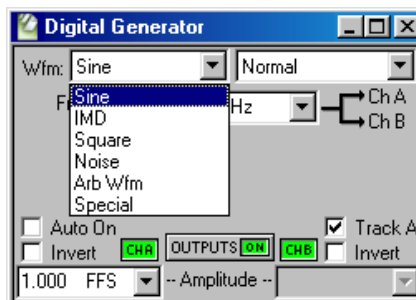

These list selections are, for the most part, sorted by the shape of the waveform, such as sinewave, squarewave, noise, and so on. Most waveform choices have an associated secondary list, from which you make your final waveform selection.

This chapter organizes the waveforms by shape. The variations available on the secondary lists are described under each section.

Sine waveforms

This section describes the sine waveforms available to the Digital Generator, which cover the frequency range from 2 Hz to just under 50% of the

sample rate (which is approximately 24 kHz at a 48 kHz sample rate). The frequency can be set in hertz or in a number of relative units; see **Frequency Units**, page 372.

Figure 75. Digital Generator Sine Waveform Selections.

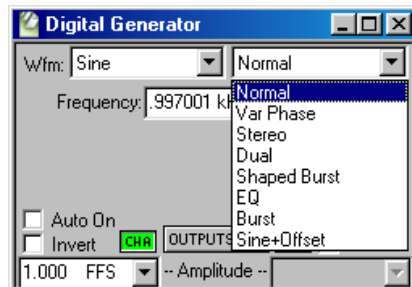

Wfm: Sine: Normal

Figure 76. Digital Generator Sine Normal.

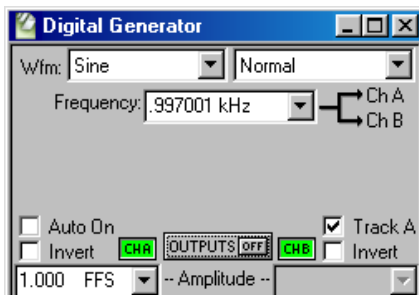

The normal sine waveform is the standard waveform for most audio testing, and is the default generator waveform.

Wfm: Sine: Var Phase

Figure 77. Digital Generator Sine Var Phase.

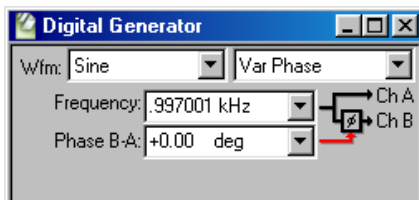

This selection produces the selected frequency at both Channel A and B outputs, but the phase of the Channel B output is variable from -180° to $+179.99^\circ$ with respect to the Channel A output, as controlled by the **Phase** field.

A positive value entered in the **Phase B-A** field will cause the Channel B output to lead the Channel A output. A negative value entered in the

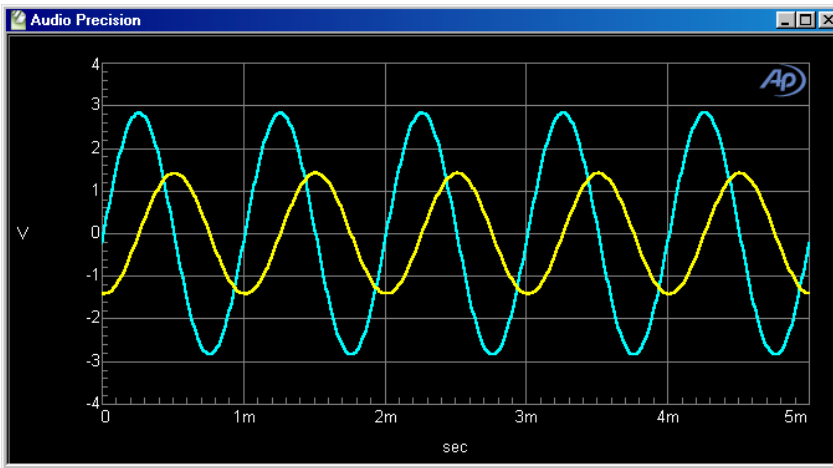
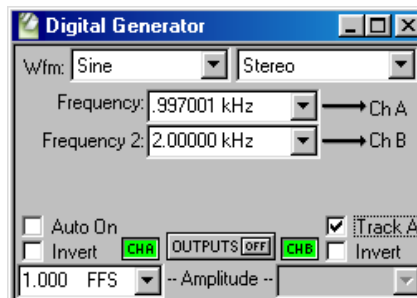

Figure 78. Sine: Var Phase, triggered on Channel A (the larger waveform). -90.00 deg has been entered in Phase B-A field, causing B (the smaller waveform) to lag A.

Phase B-A field will cause the Channel B output to lag the Channel A output. See the illustration below:

Wfm: Sine: Stereo

Figure 79. Digital Generator Sine Stereo.



This waveform selection produces independent sinewaves on Channel A and Channel B. The **Frequency** field sets the frequency of the Channel A signal, and the **Frequency 2** field sets the frequency of the Channel B signal. Their amplitudes are independently set by the two **Amplitude** fields unless the **Track A** box is checked, in which case the amplitudes are equal and controlled by the Channel A **Amplitude** field.

Wfm: Sine: Dual

This selection produces two independent sinewaves which are summed to create a complex waveform. This complex waveform is sent to both channel outputs.

Figure 81. Digital Generator Sine Dual.

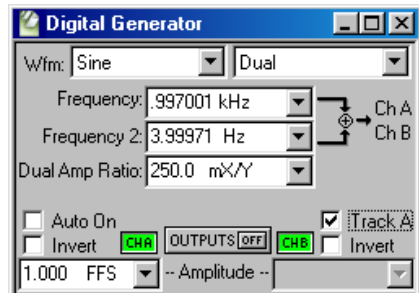

The **Frequency** and **Frequency 2** fields permit each component sinewave frequency to be set independently. The **Dual Ampl Ratio** field enables you to set the ratio by which the secondary (**Frequency 2**) sinewave component amplitude will be attenuated with respect to the amplitude of the primary (**Frequency**) sinewave component.

The **Sine: Dual** signal is particularly useful as a calibration signal for harmonic distortion analyzers, where the **Frequency** signal at reference amplitude represents the fundamental signal. The secondary (**Frequency 2**) sinewave can be set to any desired harmonic of the primary (**Frequency**) “fundamental” sinewave, at an amplitude to represent any desired distortion level. For example, setting the primary (**Frequency**) at 1 kHz and the secondary (**Frequency 2**) at 3 kHz with a **Dual Amp Ratio** of -40.0 dB (1%) produces a 1 kHz signal with third harmonic distortion of 1.0%.

Wfm: Sine: Shaped Burst

Figure 80. Digital Generator Sine Shaped Burst.

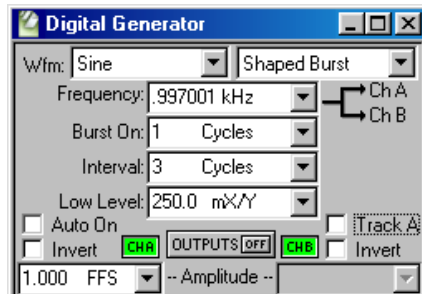

A tone burst is an audio signal (usually a sinewave) that is keyed on and off. Tone bursts are often used as stimulus signals, and can reveal characteristics of a DUT’s performance which are not observable with continuous tones.

The Digital Generator **Sine: Shaped Burst** signal is essentially identical to the Analog Generator **Sine: Shaped Burst** signal, and both are similar to the Digital Generator **Sine: Burst** signal.

Figure 82. An example of a shaped burst.

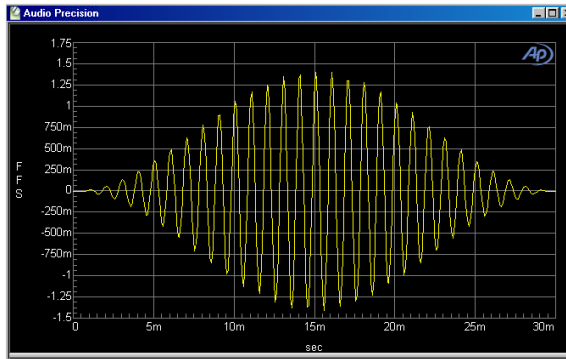

For both generators, the **Sine: Shaped Burst** has a raised-cosine shaped envelope, creating a relatively narrow energy spectrum around the sinewave frequency. The Digital Generator **Sine: Burst** has a rectangular envelope with fast rise and fall times and consequently a wider spectrum of energy.

Refer to **Tone Bursts**, page 109, for information on making tone burst settings.

Wfm: Sine: EQ

Figure 83. Digital Generator Sine EQ.

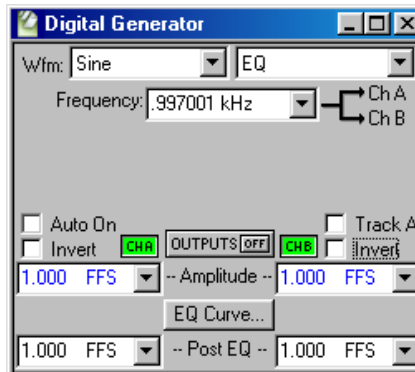

Generator Equalization

The **Sine: EQ** setting outputs a normal sinewave, with equalizing amplitude changes made in the generator level according to an attached EQ data file. This enables you to make a frequency sweep where the generator amplitude varies as instructed by the data in the attached file.

When you select **Sine: EQ** and attach an EQ file (see below), a new field named **Post EQ** appears on the Digital Generator panel. The **Post EQ** field displays the generator amplitude to be applied to the DUT, which

is the value entered in the **Amplitude** field, corrected by the value (at that frequency) of the correction factor in the attached EQ file.

*When **Sine: EQ** is selected, the values in the **Amplitude** field are displayed in **blue** rather than **black**.*

To set the output amplitude, you can enter a value in either the **Amplitude** field or the **Post EQ** field, and the value in the other field will be properly adjusted according to the correction factor.

The Digital Generator will not permit an output amplitude entry greater than 1.000 FFS (0 dBFS). If the value of the normal (pre-EQ) **Amplitude** field as modified by the equalization file would produce an amplitude greater than 1.000 FFS, an error message is displayed.

If a frequency value outside the frequency range span of the EQ file is entered on the generator panel or occurs during a sweep, the **Post-EQ** amplitude will go to 0 FFS.

Specifying the EQ Curve

The EQ curve is specified by an ATS data file (usually an EQ file, with the extension .atsq) which lists frequencies in **Column 1** and the corresponding amplitude changes in **Column 2** (or another column of your choice).

Figure 84. EQ file attachment and editing.

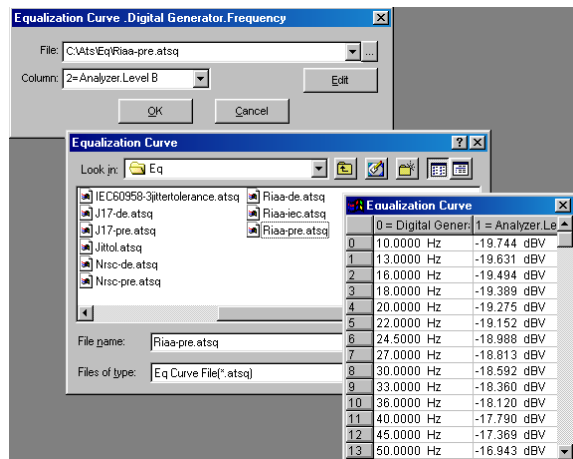

Click the **EQ Curve** button to open the Equalization Curve dialog box, then click the browser button to open the Equalization Curve file browser.

When you have selected an EQ file, it will be attached to the generator panel and the file name will appear in the Equalization Curve dialog box.

The default amplitude data column is **Column 2**; you can choose another column from the drop-down list in the Equalization Curve dialog box.

If you would like to view or edit the EQ file, click the **Edit** button to open the Attached File Editor (see page 313).

You can create custom EQ curves by manually creating an ATS EQ file, or by using the current sweep data in memory and a Compute function to produce an appropriate EQ file. See Chapters 18 and 19 for more information on saving data files and modifying EQ data from a sweep using Compute functions.

Typical EQ Applications

The most common applications of generator equalization are to produce a nominally flat output from a device which contains a known equalization function. Typical examples would be U.S. FM and TV aural broadcast transmitters using 50 μ s and 75 μ s preemphasis curves.

By attaching an equalization curve to the ATS-2 generator that is the inverse of the nominal curve used in the device under test, the resulting measured output should be flat. Small variations from flatness will be a measurement of the accuracy of equalization in the device, since the .atsq curves provided are accurate to better than 0.01 dB and the specified generator flatness is of the same order.

Wfm: Sine: Burst

Figure 85. Digital Generator Sine Burst.

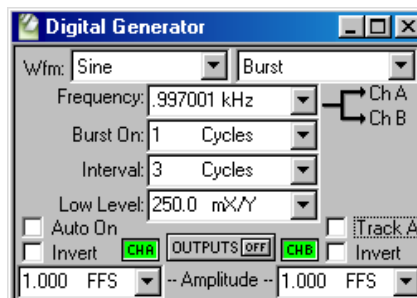

The frequency of the sinewave is set in the **Frequency** field. The **Amplitude** field sets the generator amplitude at the maximum burst ON level.

Figure 86. Tone Burst Definitions.

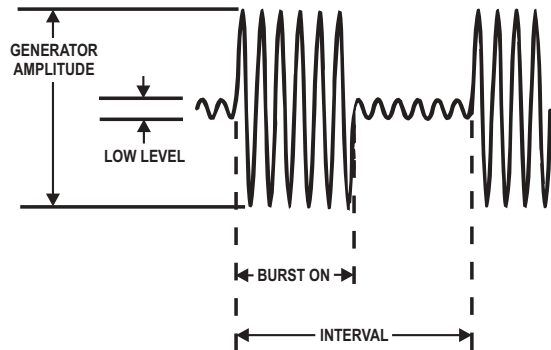

Refer to Figure 54 for definitions of the following settings:

■ Burst

Enter a value in the **Burst On** field to set the duration of the tone burst. The maximum **Burst On** duration is 65,535 cycles of the sine waveform, if **Interval** is set to its maximum; the minimum is 1 cycle. **Burst On** can be set in units of **Cycles** or **s B** (seconds, Burst). Only **Burst On** durations which are less than the **Interval** durations can be entered.

■ Interval

Enter a value in the **Interval** field to set the period between the onset of the tone burst and the onset of the next burst. The maximum **Interval** is 65,536 cycles of the sine waveform; the minimum is 2 cycles. **Interval** can be set in units of **Cycles** or **s B**.

Interval does not describe the time between the end of a burst and the beginning of the next, but the entire period from the beginning of one burst until the beginning of the next.

■ Low Level

When a tone burst is ON, the level of the sinewave in the burst is the same as the current **Amplitude** setting for the Digital Generator. When a tone burst is OFF, the low level is the ON level multiplied by the value set in the **Low Level** field. The OFF level is a ratio of the ON level, set here in units of **X/Y** ratio, **dB**, **%** (per cent), or **PPM**. See **Ratio Units**, page 378.

If **Low Level** is set to equal the burst high-level amplitude, no burst effect will occur and the output will be a continuous sinewave.

At large amplitude ratios, the amplitude resolution of **Low Level** becomes poorer. The display will show the actual available resolution steps, rather than the value entered.

Zero-Crossing

The beginning and ending of any tone burst are always at the positive-going zero-crossing points of the sinewave, which eliminates transients from the output.

Because of the zero-crossing nature of the tone bursts, only integer numbers of cycles can be entered as a **Burst On** or **Interval** setting; if you are using **s B** units, only time durations which represent multiples of the full period of a cycle of the selected sinewave can be entered as a **Burst On** or **Interval** setting.

Wfm: Sine+Offset

Figure 87. Digital Generator
Sine + Offset.

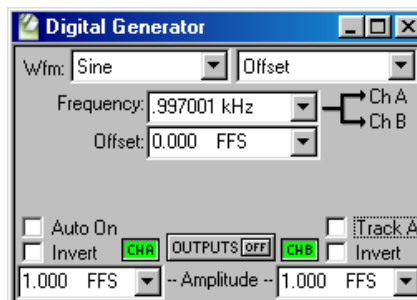

This waveform is a combination of a sinewave with a digital DC signal. Digital DC is essentially the same digital code sent for every sample; see **Wfm: Special: Constant Value** on page 120. The frequency of the sinewave for the **Sine + Offset** waveform, like the other Digital Generator sinewaves, can be set in the range of 2 Hz to 50% of the sample rate; the sinewave level is set in the **Amplitude** field(s).

The digital DC signal amplitude, which can have a positive or negative value, is set in the **Offset** field. The sum of the sinewave and DC amplitudes may not exceed positive or negative full scale (FS). If the sinewave amplitude is 0 FS the **Offset** value may be set anywhere in the range between -1.0 FS and $+1.0$ FS; if the sinewave amplitude is at full scale, the **Offset** must be 0 FS.

Although the sinewave amplitude may be set independently for Channel A and Channel B, the **Offset** value is common to both channels.

A low-amplitude sinewave with an **Offset** value that positions the sinewave at a major bit-switching point of a ladder-type D-to-A converter is particularly useful for testing linearity at various points in the converter's operating range.

Intermodulation Distortion (IMD)

Intermodulation distortion (IMD) testing requires a stimulus which is a combination of two waveforms, and a specific analysis technique to evaluate interaction of the waveforms within the DUT.

Figure 88. Digital Generator IMD Waveform Selection.

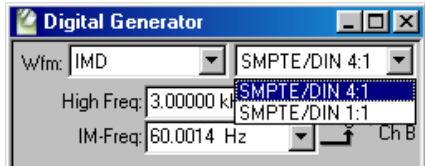

ATS provides two versions of the SMPTE/DIN standard IMD test signals.

IMD signal amplitude is set in the Digital Generator **Amplitude** field. The IMD composite waveform amplitude is calibrated in peak equivalent sinewave terms. See **Amplitude Control and Units** on page 102.

Wfm: IMD: SMPTE/DIN 4:1

This selection produces a signal which is the linear combination of two sinewaves. The first sinewave, set in the **IM-Freq** field, is a lower-frequency tone that can be assigned any frequency in the range of 40 Hz to 500 Hz. The frequency of the second sinewave, set in the **High Freq** field, can be anywhere in the range from 2 kHz to 50% of the sample rate.

The low-frequency sinewave is linearly combined in 4:1 amplitude ratio with the high-frequency sinewave.

Wfm: IMD: SMPTE/DIN 1:1

This is the same as the **Wfm: IMD: SMPTE/DIN 4:1** selection, except that the amplitude ratio of the low-frequency sinewave to the high-frequency sinewave is 1:1.

Squarewave

Figure 89. Digital Generator Squarewave Waveform.

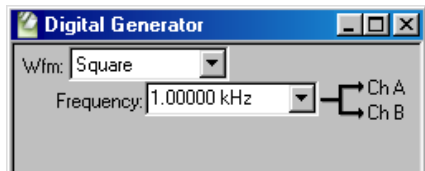

Wfm: Square

The squarewave amplitude is calibrated in peak equivalent sinewave terms. See **Amplitude Control and Units** on page 102.

The frequency range for squarewaves is from approximately 2 Hz to 1/6 of the sample rate (8 kHz at a 48 kHz sample rate; 7.35 kHz at a 44.1 kHz rate).

In order for the squarewave be synchronous with the sample rate and have a time-symmetric duty cycle, the available squarewave fundamental frequencies within that range are limited to *even integer submultiples* of the sample rate, with the highest frequency being $SR/6$ and the lowest being $SR/2^{24}$.

For example, at a 48 kHz sample rate, the highest squarewave frequencies are:

- 8 kHz (48000/6)
- 6 kHz (48000/8)
- 4.8 kHz (48000/10)
- 4.0 kHz (48000/12)
- 3.42857 kHz (48000/14), and so on.

White Noise

Figure 90. Digital Generator Noise Waveform.

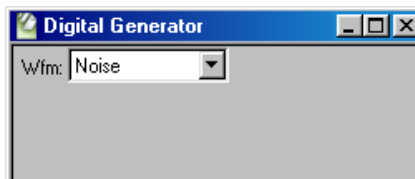

Wfm: Noise

The ATS-2 Digital Generator offers a DSP-generated white noise signal.

The DSP-generated noise is pseudo-random and has a length of 2^{20} or 1,048,576 samples, which means that with the DIO **OSR** set to a sampling rate of 48 kHz the noise pattern repeats about every 22 seconds. The noise has a zero mean, a crest factor of 1.73 and a rectangular probability distribution function.

The spectrum of the noise is flat from just above 0 Hz to just below half the sampling rate, and consists of spikes spaced at $SR/2^{20}$ Hz.

White Noise Characteristics

The spectral distribution of white noise is characterized by equal noise energy per hertz. This means that the spectral range between 100 Hz and 200 Hz will have the same energy as the range between 10,000 Hz and 10,100 Hz.

If analyzed by a constant-bandwidth spectrum analyzer such as a superheterodyne or FFT analyzer, white noise will show a flat energy characteristic versus frequency (up to the bandwidth limitation).

Analysis of white noise with a constant-percentage-bandwidth (constant Q) filter such as in the Audio Analyzer **Bandpass** mode (or as in most real-time analyzers) will show a rising characteristic versus frequency, at the rate of 3 dB per octave.

Arbitrary Waveforms

Figure 91. Loading an arbitrary waveform.

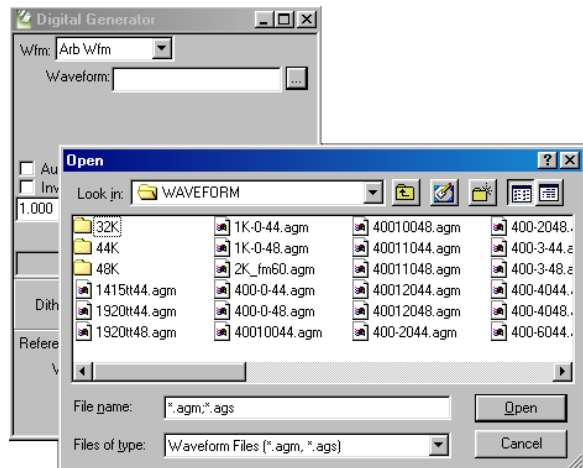

The generator arbitrary waveform function allows you to load a properly-formatted digital waveform file into the ATS-2 DSP and route the waveform to the Digital Generator outputs.

Arbitrary waveforms files provided with ATS-2 include single tones, tone combinations for IMD testing, multitone waveforms and calibration tones, and other useful waveforms.

Waveform files must be of the Audio Precision .agm (**Generator Mono**) or .ags (**Generator Stereo**) file types. You may also make custom arbitrary waveform files using a file creation utility provided with ATS-2 or with third-party applications such as MATLAB. See **Multitone Creation** on page 236.

To load a waveform file and then output the waveform so that the embedded audio tones are at the intended frequencies, the DIO output sample rate (**OSR**) must be set to the same sample rate that was used in creating the file. ATS offers two sampling rate options for loading an arbitrary waveform, which are set on the Configuration panel at **Utilities > Configuration**.

If the **Set sample rate when loading generator waveforms** checkbox on the Configuration panel is checked, ATS will automatically set the DIO **OSR** to match the sample rate of the file being loaded. If this checkbox is unchecked, you must manually enter the sampling rate you desire in the **OSR** field on the DIO panel.

If you enter a sampling rate different from the sampling rate at which the file was created, the frequencies of the audio tones embedded in the output signal will be shifted by the ratio of the two sampling rates.

The DSP processes in the multitone audio analyzer require that the multitone be precisely correct for synchronous operation. If the tones have been frequency-shifted, the Multitone Analyzer FFTs will not be synchronous, and FFT windows will be necessary. See Chapter 13 for more information on multitone testing.

*The Arbitrary Waveform generation memory buffers of the Analog Generator and Digital Generator are shared. If both generators have **Arb Wfm** selected as the waveform, the same waveform file will be used for both and the same signal will be produced at both the analog and digital generator outputs.*

Special Waveforms

Figure 92. Digital Generator Special Waveform Selections.

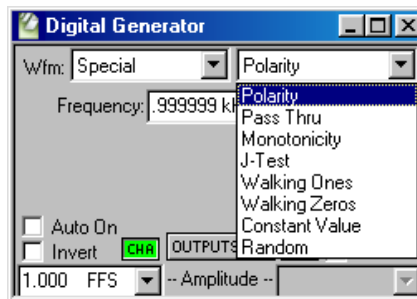

Wfm: Special: Polarity

The polarity waveform is designed to be obviously asymmetrical, so that it is easily apparent if signal is inverted or not. The waveform is the sum of

Figure 93. Digital Generator Special Polarity.

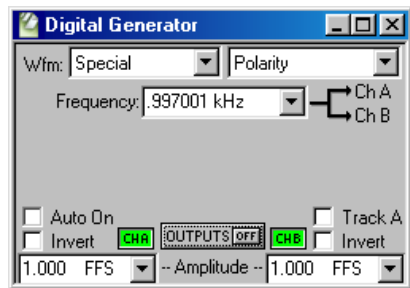

the fundamental tone set in the **Frequency** field and its second harmonic, in a fixed phase relationship.

When the output of the DUT is viewed using an oscilloscope or the ATS Spectrum Analyzer in the time-domain view, the signal will reveal whether or not there has been a polarity inversion in the DUT or in the signal interconnections.

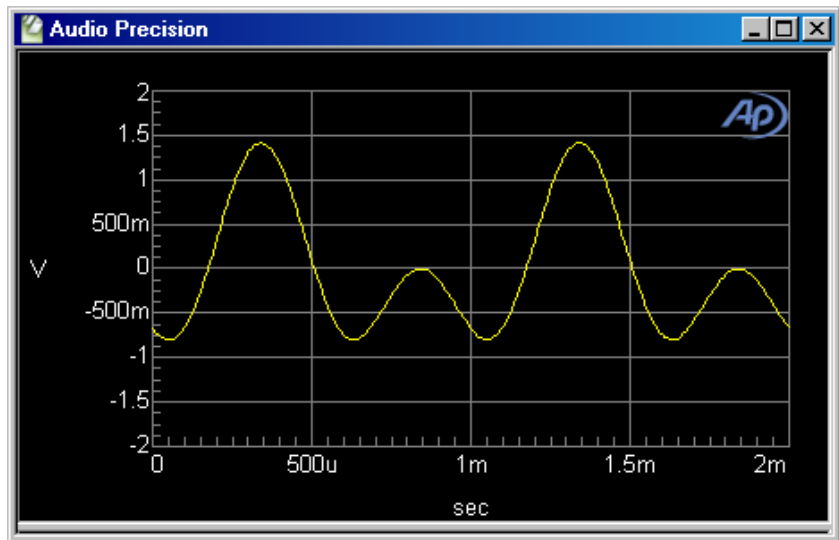

Figure 94. Polarity waveform, normal polarity shown.

The only setting available for the polarity waveform is **Frequency**.

Wfm: Special: Pass Thru

The **Special: Pass Thru** selection does not cause a waveform to be generated; instead, it passes the digital audio signal connected to the rear panel **SYNC /REF IN** BNC connector through to the Digital Generator output.

Since the sample rate at the Digital Generator output is set at the DIO **OSR**, this is a convenient way to synchronize an external test signal with ATS-2. You can also use **Pass Thru** to convert an external signal from one sample rate to another, as might be necessary when working at a 48 kHz sample rate but using a Compact Disc with test signals at a 44.1 kHz sample rate as a source.

The **REF IN** signal sample rate must be between 28.8 kHz and 108 kHz. The ratio between the **OSR** and the **REF IN** signal sample rate is calculated by ATS and a sample rate converter is used to maintain the output audio frequency at the **REF IN** audio frequency value. The Digital Generator output signal is then synchronized and frame-synced to the converted **REF IN** signal. Additionally, the ratio of the **REF IN** sample rate to the **OSR** must fall in the range between 1:3 to 3:1; or, stated another way,

$$\frac{OSR}{3} \leq REF\ IN\ SR \leq OSR \times 3.$$

The range of the **OSR** is 28.8 kHz–108 kHz. To avoid attenuation and distortion in **Special: Pass Thru**, the **REF IN** audio frequency must not exceed $0.47 \times OSR$.

If the **REF IN** signal is stereo, the output signal will also be stereo. Status bytes are not passed through to the output, but are set on the Status Bytes panel as usual. You can choose whether or not to dither the re-sampled **REF IN** signal.

The amplitude relationship between the **REF IN** signal and the Digital Generator output is controlled by the Digital Generator output amplitude setting. A setting of 1.00 FS (0 dB FS) will pass the **REF IN** signal unattenuated, and lower settings of generator amplitude will attenuate the audio level.

Wfm: Special: Monotonicity

Figure 95. Digital Generator Special Monotonicity.

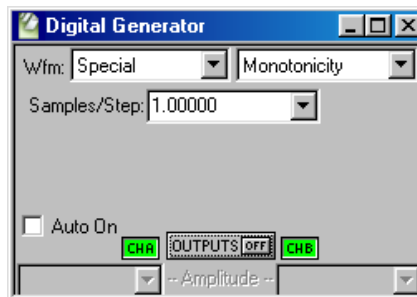

Monotonicity is a low-amplitude “staircase” waveform. It consists of five complete cycles of squarewave at each of the ten lowest non-zero digital

amplitude states, plus the same time period at zero. Since this definition is with reference to the minimum possible amplitude, the absolute amplitude of the steps depends on the **Output: Resolution** value (word width, in bits) on the DIO panel.

The squarewave half-cycle duration is controlled by the **Samples/Step** field. For example, with a **Samples/Step** value of **10** at a 48 kHz sample rate, the squarewave half-period is $10/48,000$ seconds, or $208.3 \mu\text{s}$; each equal-amplitude section is ten half-periods long, or 2.083 ms ; and each eleven-step repetition occurs at a rate of $11 \times 2.083 \text{ ms}$, or every 22.92 ms .

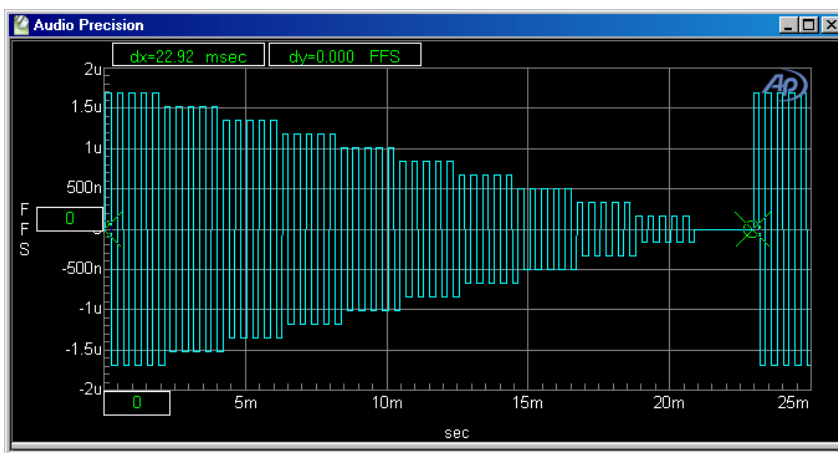

Figure 96. Monotonicity waveform. 24-bit word width, 10 samples/step, 48 kHz sample rate.

Dither is disabled when the Monotonicity waveform is selected.

The Monotonicity waveform is used principally in testing low-level linearity of D-to-A converters and digital domain devices by viewing their output in the time domain, using the Spectrum Analyzer instrument.

*In the Spectrum Analyzer instrument panel, Select **Digital Gen** as the **Trigger: Source**. The **Wave Display** field on the panel should be set to either **Display Samples** or **Absolute Value**, but not **Interpolate**. See Chapter 11 for more information about using the Spectrum Analyzer.*

Non-linearity is shown by unequal step-to-step amplitudes. Non-monotonicity is indicated by a reversal in direction of the pattern of constant decrease from step to step.

Wfm: Special: J-Test

J-Test is a waveform which produces a maximum amount of data-induced jitter on low-bandwidth digital transmission links. **J-Test** consists of a squarewave at one-fourth the sample rate, combined with a second, low-frequency low-amplitude squarewave that has a digital DC offset.

Dither is disabled for **J-Test** and no amplitude control is available, since the signal definition specifies exact data values. The **J-Test** signal would normally be transmitted while measuring jitter at the receiving end of a cable or digital transmission system, to estimate the worst-case magnitude of jitter caused by reduced bandwidth of the transmission link.

Wfm: Special: Walking Ones and Walking Zeros

Figure 97. Digital Generator Special Walking Ones.

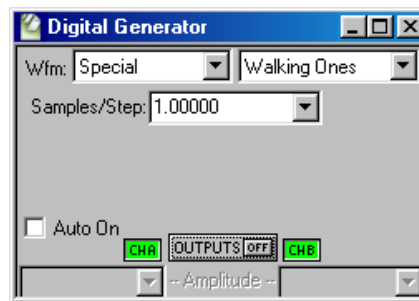

Walking Ones is a signal in which only one bit is at logical “one” at any moment, with the others all at logical “zero.” The position of the bit which is at logical “one” is stepped continuously through the word from LSB to MSB to LSB and back to MSB again, at a rate controlled by the **Samples/Step** field.

Figure 98. Digital Generator Special Walking Zeros.

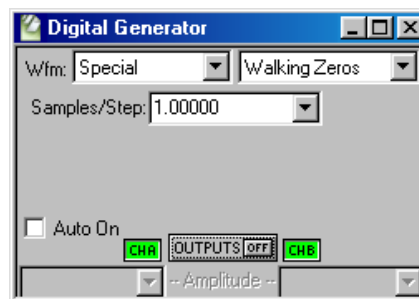

Walking Zeros is similar except that only one bit is at logical “zero” and all others are at logical “one.”

Walking Ones and **Walking Zeros** are typically used in troubleshooting circuitry where the digital word appears in parallel format, in order to

find “stuck bits.” Dither is disabled for **Walking Ones** and **Walking Zeros**, and the amplitude is fixed.

The walking waveforms can be observed on the DIO panel by viewing the bit indicators in the **Data Bits** mode (rather than **Active Bits** mode). Set the **Samples/Step** value to approximately half the sample rate (24000 for a 48 kHz rate), which results in a 0.5 second per step walking rate. Slower computers may require a larger **Samples/Step** value for proper display on the DIO panel.

Wfm: Special: Constant Value

The **Special: Constant Value** waveform provides essentially the same digital code at every sample. This is the digital domain equivalent of an analog DC signal. Digital DC is usually dithered, like most digital waveforms, so the actual values at each sample will vary slightly by the amount of the applied dither.

There is no frequency control field for the **Constant Value** waveform. The output **Amplitude** fields set the amplitude of the DC for each channel.

Wfm: Special: Random

Special: Random is a specific, predictable pseudo-random waveform uniformly distributed across the entire range of code values between plus and minus full scale. It is intended for error-rate testing of communications links, AES3 interfaces, and digital recorders.

Random is identical to the **Bittest Random** waveform of Audio Precision Systems One and Two and the **RAND** waveform of Portable One Dual Domain; it may be used with the bit error analysis capability of any of those instruments.

Dither is disabled for the **Random** waveform.

Dither

Dither is low-level noise that is combined with the signal to improve linearity, reduce distortion at low amplitudes, and extend the linear operating range below the theoretical minimum for undithered PCM signals of any particular resolution.

The dither noise is introduced before quantizing and serves to randomize the quantization distortion and produce an undistorted signal with a slightly higher noise floor. The elimination of quantization noise results in a more acceptable audio signal.

Dither Type

Figure 99. Digital Generator Dither settings.



The **Dither Type** list on the Digital Generator panel allows you to select three types of dither for the generator output signal, or none. The dither type names “rectangular” and “triangular” describe the shape of the graphs of the probability distribution function (PDF) of the noise signal chosen for dither. The effects of dither on a digital audio signal change with the level of dither applied and with the PDF of the dither noise signal.

The **Output Resolution** field on the DIO panel controls the amplitude of the dither added to the digital generator output. Proper dither amplitude for a 16-bit system, for example is obtained by entering **16** in the **Output Resolution** field.

The **Dither Type** list choices are:

- **Triangular.** Triangular probability distribution function (TPDF) dither is the default setting in ATS, and is recommended for most measurement applications. It produces a slightly higher noise floor than RPDF dither, but it imparts no noise modulation effect to the audio. Triangular dither can add or subtract up to one LSB peak amplitude at the selected resolution.
- **Rectangular.** Rectangular probability distribution function (RPDF) dither provides a better signal-to-noise ratio than triangular dither, but suffers from noise modulation effects. Rectangular dither can add or subtract up to one-half LSB peak amplitude at the selected resolution.
- **Shaped.** Shaped dither is TPDF dither shaped through a filter, resulting in a dither signal with a rising 6 dB-per-octave slope, set with the 0 dB effect point at one-half the sampling rate. This places most of the dither power at higher frequencies, where much of the resultant noise falls out-of-band for most devices, and where audibility is lower.
- **None.** No dither is applied.

Certain generator waveforms, such as **Monotonicity**, **J-Test**, **Walking Ones** or **Zeros**, and **Random** waveforms are only usable with no dither. When one of these waveforms is selected, dither is automatically disabled and the **Dither Type** field is not available.

Digital Generator References

With the appropriate choice of units, amplitude and frequency settings in the Digital Generator can be made relative to reference values. These references are entered manually in the Digital Generator **References** area.

Figure 100. Digital Generator References.

References	
Volts/FS:	1.000 V
Freq:	.997000 kHz
dBr:	387.3 mFFS ▼

Volts for Full Scale Reference

Digital full scale (FS) is defined as the rms value of a sinewave whose peaks just touch the maximum values of the coding scheme. When expressed in analog domain units, there must be a reference given to establish the level relationship between the two domains. For Digital Generator settings, that reference is entered as the rms voltage which is to correspond to a full scale digital audio signal.

Set the Digital Generator volts for full scale reference in the **References: Volts/FS** field.

Frequency Reference

The *relative* units of measurement for the Digital Generator are **F/R**, **dHz**, **%Hz**, **cent**, **octs**, **decs**, **d%**, and **dPPM**.

In a relative expression, the frequency setting or reading is expressed in relation to a second reference frequency. For Digital Generator relative frequency settings, this reference frequency is entered in hertz in the Digital Generator **References: Freq** field.

dBr Reference

The dBr (which is shorthand for “decibels relative to a reference”) reference is an easy way to set a nominal level against which your settings or readings are made. Enter a reference value in the **References: dBr** field.

You can set a Digital Generator **dBr** reference in **FFS**, **%FS**, **dBFS**, **bits**, **V**, **Vp**, **Vpp**, **dBu**, **dBV**, **dec** or **hex** units.

Chapter 10

The Audio Analyzer

Overview

The **Audio Analyzer** is a DSP instrument selection on the Analyzer panel. It is one of the key audio analysis tools available in ATS. The **Audio Analyzer** can measure audio level, frequency, noise, THD+N, crosstalk, phase and more, with a wide selection of filters and detector characteristics. For many measurements, the **Audio Analyzer** is the only instrument you will need.

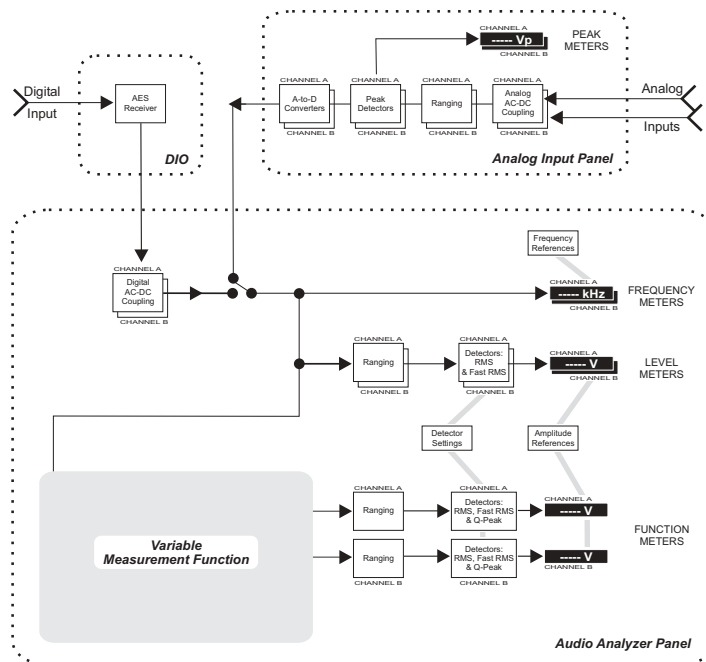

Figure 101. Conceptual Block Diagram, Audio Analyzer.

This chapter examines each function, control and display of the **Audio Analyzer** in detail. If you are new to ATS-2, you might want to start with the Quick Guides in *Getting Started with ATS-2*, which will introduce you to **Audio Analyzer** features.

The **Audio Analyzer** will measure either digital or analog domain audio input signals, as selected by the **Input** field. It is a two-channel instrument, capable of performing measurements on both channels of a stereo signal at the same time. For an analog signal, the **Audio Analyzer** can measure a frequency range from DC to about $0.45 \times F_s$, where F_s is the sample rate of the inputs ADCs set on the Analog Input panel; for digital signals, the **Audio Analyzer** can measure a frequency range from DC to $0.5 \times F_s$.

There are three pairs of meters on the **Audio Analyzer** which measure the input signal simultaneously:

- the **Level** meters,
- the **Freq.** (frequency) meters, and
- the **Function** meters.

As on other ATS panels, you can select the units of measurement you prefer for each reading display. Other fields on the **Audio Analyzer** panel allow you to choose coupling, filter, detector and level reference options. Some of these options, however, apply only to the **Function** meters, as you will see later in this chapter.

Loading the Audio Analyzer

Figure 102. Loading the Audio Analyzer.

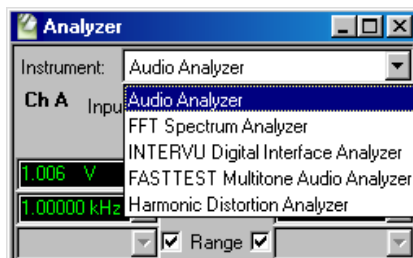

To use the **Audio Analyzer**, first open the Analyzer panel. The Analyzer panel is a command selection on the Panel menu, and is also available by the keyboard shortcut **Ctrl+Y**, or by clicking the **Analyzer** button on the Toolbar.

Figure 103.
The **Audio Analyzer** panel.

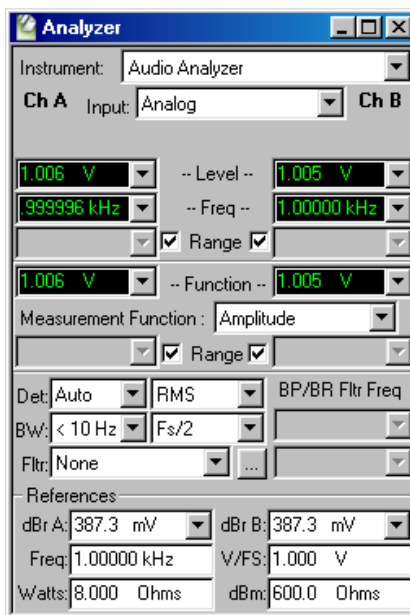

The **Audio Analyzer** is loaded in the Analyzer panel as the default instrument. If another Analyzer instrument is loaded, drop down the list and choose **Audio Analyzer**.

Signal Inputs

Figure 104.
Audio Analyzer panel inputs.

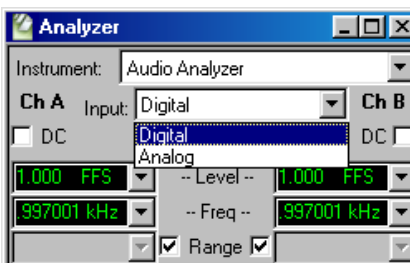

The **Input** field of the **Audio Analyzer** offers two signal input selections: **Digital** and **Analog**. These choices access signals from the Digital Input/Output (DIO) panel or the Analog Input panel, respectively.

Digital signals are sent directly to the **Audio Analyzer** DSP; analog signals are first digitized by precision ADCs (selected on the Analog Input panel) before being sent to the **Audio Analyzer**.

To select digital input connectors, digital input format and configure other aspects of the serial interface, go to the DIO panel (see Chapter 7).

To select analog input connectors, range, coupling, and ADCs, go to the Analog Input panel (see Chapter 6).

You will notice that as you select **Digital** or **Analog** the appearance of the **Audio Analyzer** panel changes as well, displaying a different set of settings, units and references.

The Level Meters

Figure 105.
The **Audio Analyzer** Level Meters.

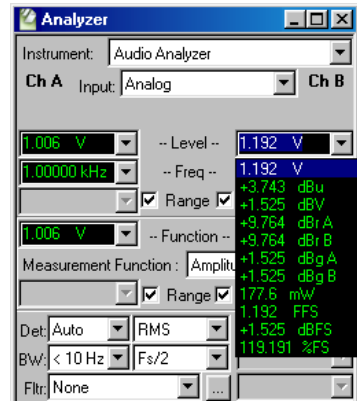

Two Level meters are located near the top of the **Audio Analyzer** panel, one for each input channel. The Level meters display the audio amplitude of the input signals. These meters are true rms instruments, using the normal or the fast rms detector as selected in the Detector (**Det**) field lower on the panel.

The meter detectors are discussed in more detail on page 141.

*Note: Detector choices affect both the **Level** meters and the **Function** meters. However, the **Q-Peak** choice is only effective on the **Function** meters. If **Q-Peak** is selected, the **Level** meters use the normal rms detector.*

Level Meter Units

If you click on the arrow to the right of either Level meter reading field, a list of measurement unit choices will drop down. The units shown on the list depend upon whether **Analog** or **Digital** is selected in the Input field.

With **Digital** selected, the units list includes

- digital domain units: **FFS**, **dBFS**, **%FS** and **Bits**;
- relative units: **dBBr A** and **dBBr B**;
- and units relative to the analog domain: **V**, **dBu**, and **dBV**.

These analog domain units are calculated relative to the value you enter in the **V/FS** field in the References area of the panel, and can be helpful in cross-domain measurements. When measuring an ADC, for example, you could enter the full-scale analog input voltage of the converter into the **V/FS** field and view your results here using one of the analog domain units available.

With **Analog** selected, the units list includes

- analog domain units: **V**, **dBu**, **dBV**, **dBm** and **W** (watts);
- relative units: **dBr A**, **dBr B**, **dBg A**, **dBg B**;
- and units relative to the digital domain: **FFS**, **dBFS** and **%FS**.

For an explanation of the units of measurement used in ATS and the references for the relative units, go to Appendix A, **Units of Measurement**.

AC and DC Coupling

There are a few issues to consider when examining AC and DC signal coupling in ATS-2.

- For signals in the analog domain, capacitors can be switched in and out of the input circuits to block or pass DC. When **Analog** is selected as the Audio Analyzer **Input**, AC or DC coupling is controlled from the Analog Input panel, as explained in Chapter 4.
- For signals in the digital domain, blocking or passing DC is accomplished in DSP. When **Digital** is selected as the Audio Analyzer **Input**, DSP AC or DC coupling is controlled from the Audio Analyzer panel, as explained below. This selectable coupling affects the readings shown on the Audio Analyzer **Level** and **Frequency** meters; the **Function** meters, as you will see below, always have a high-pass filter implemented, effectively blocking DC to the various **Function** readings under all circumstances.

Also refer to the block diagram in Figure 101.

Figure 106.
The **Audio Analyzer Level Meters**
Coupling Options (Digital Input Only).

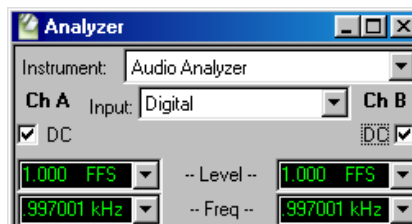

With **Input** set to **Digital**, the selections on the Audio Analyzer panel operate as follows:

- When the check box for either channel is unchecked, DC is blocked in DSP for that channel;
- When the check box for either channel is checked, DC is passed for that channel.

Common-Mode Testing and Coupling Issues

When making common-mode tests, small DC offsets from the DUT can result in significantly different measurements. If your goals do not require measurements that extend below the audio range to DC, it is usually advisable to use AC coupling to block any DC offset.

For analog inputs, it's usually best to use the Function meters, which are always AC-coupled. This is because the use of the Level meters in an AC-only mode requires that the DC be blocked in the Analog Input circuitry; but even with carefully-chosen, high-tolerance components, any tiny mismatch in the DC-blocking capacitors can adversely affect common-mode measurements.

For digital inputs, either uncheck the DC checkboxes and use the readings on the Level meters, or use the Function meters, which are always AC-coupled.

The Frequency Meters

Figure 107.
The Audio Analyzer
Frequency Meters.

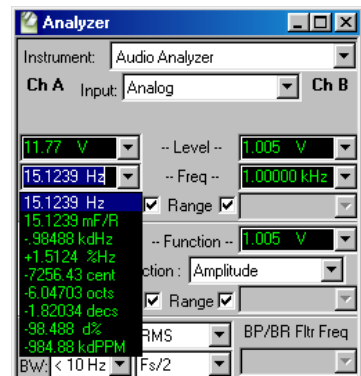

The frequency readings of the signals on the two channels are shown in the **Freq** meter fields, just below the **Level** meter readings. In ATS, the frequency meters are sometimes called frequency counters.

The units of measurement include

- the absolute frequency in **Hz**, and
- a variety of relative frequency units: **F/R**, **dHz**, **%Hz**, **cent**, **octs**, **decs**, **d%** and **dPPM**.

All the relative frequency units are computed with respect to the **Freq** value entered in the References: Freq field lower on the panel. For specific definitions of these relative frequency units, see the **Frequency Units** discussion on page 372.

Meter Ranging

Practical devices have an optimum amplitude operating range in which they exhibit their best performance. ATS-2 gives you the choice of automatic ranging (or *autoranging*) or manually setting a fixed maximum range.

Ranging is controlled independently at two different points within the **Audio Analyzer** instrument, as shown on Figure 101. The upper set of **Ranging** controls acts on the A and B signals applied to the **Level** meters and **Frequency** meter displays. The lower set of **Ranging** controls acts on the two channels of the **Function** meter.

*There is an additional set of ranging circuits in the analog input circuits controlled from the Analog Input panel, discussed on page 47. If you are using the analog input to the **Audio Analyzer**, these ranging controls will also affect your measurement.*

Autoranging

The **Audio Analyzer** is normally operated with automatic ranging, indicated by a check mark in each of the appropriate **Range** check boxes. This provides operation with no possibility of clipping due to high-amplitude signals.

Click the **Range** check box to defeat autoranging. The range setting field for that meter and channel will become active, and you can enter a fixed maximum range for that input.

Fixed Range

Using a fixed range produces faster measurements, which can be important when speed is at a premium as within a repetitive routine in an automated testing macro. However, you must know the probable range of the signal and set the fixed range maximum above the highest expected level.

Manual range selection is also preferred when listening to program material such as voice or music on the built-in loudspeaker or via the headphone jack. Automatic ranging will constantly switch levels when a complex, wide-range signal is applied. This may make it difficult to adjust a device for minimum distortion or noise, for example.

ATS-2 ranges are implemented in discrete steps. When selecting a fixed range, enter the maximum expected value into the **Range** field. ATS-2 will select the next range which accommodates that value.

The Function Meters

Figure 108.
The Audio Analyzer
Function Meters.

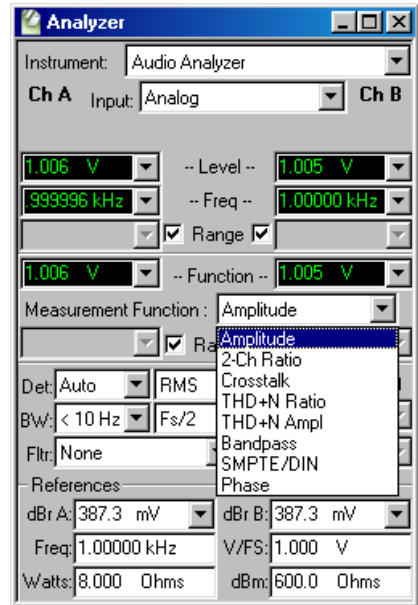

The **Level** meters examined previously display the rms amplitude of the signal applied to the **Audio Analyzer**.

The **Function** meters, which are located in the center of **Audio Analyzer**, are separate instruments which can measure the input signal in a number of different ways by applying different measurement functions. The **Function** meters also add the option of using signal filtering, as well as an additional detector selection.

The **Function** meters are the real power of the **Audio Analyzer**. Most of the measurements you will make with the **Audio Analyzer** will be using the **Function** meters, with the **Level** meters as convenient secondary signal monitors.

Function Meter Measurement Functions

The Function meter measurement function selections are:

- **Amplitude**
- **2-Ch Ratio**

- Crosstalk
- THD+N Ratio
- THD+N Ampl
- Bandpass
- SMPTE/DIN
- Phase

Each function is discussed in detail below.

Amplitude Function

Figure 109 shows a conceptual block diagram of the **Audio Analyzer** with the **Amplitude** function selected.

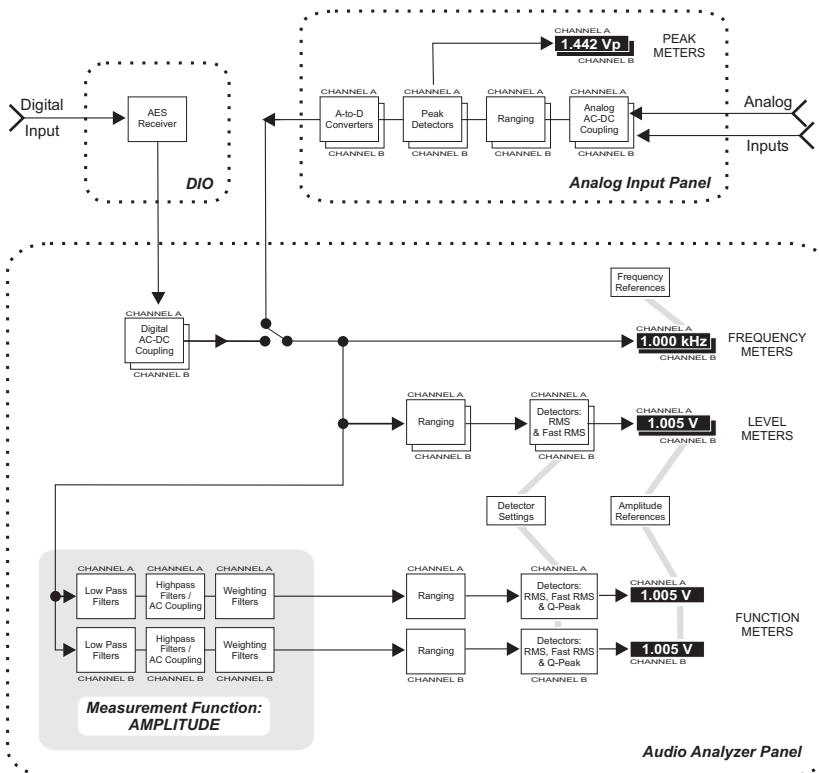

Figure 109. Conceptual Block Diagram, Audio Analyzer, Amplitude Function.

The **Amplitude** function measurements are similar to the Level meter measurements. In certain configurations the **Amplitude** function readings will be identical to the **Level** meter readings.

Amplitude measurements can differ from **Level** meter measurements for two reasons:

- **Amplitude** measurements are affected by the highpass, lowpass, and weighting filter selections made in the **BW** and **Fltr** fields, while **Level** meter readings are always unfiltered.
- In addition to the two rms detectors, **Amplitude** function measurements may be made with the quasi-peak detector; the **Level** meters always use one of the rms detectors.

Since the **Level** meters have no equalization or filtering available, you must use the **Amplitude** function for weighted or band-limited noise measurements.

2-Channel Ratio Function

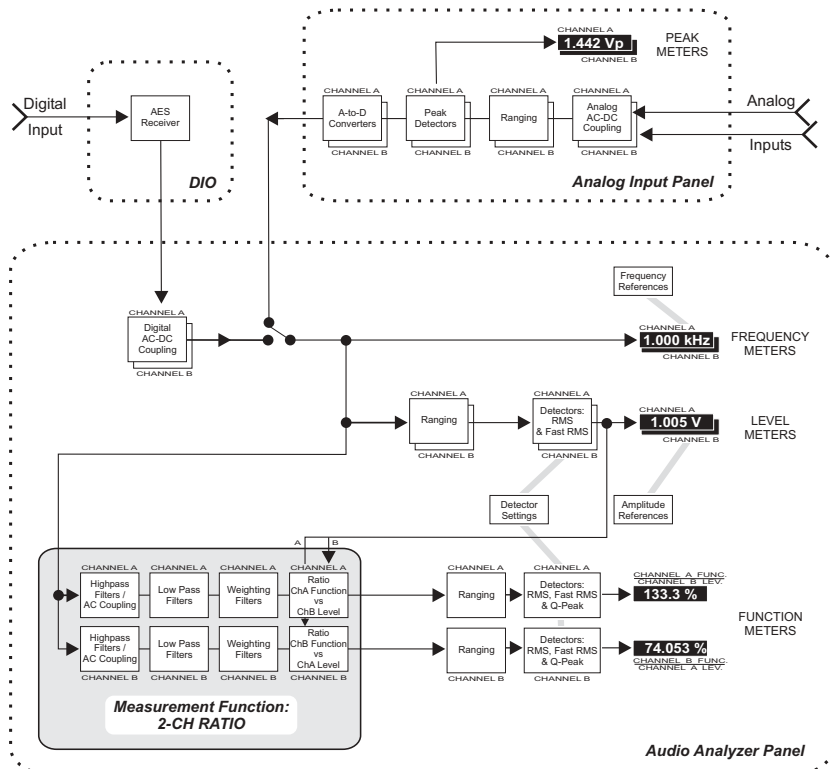

Figure 110. Conceptual Block Diagram, Audio Analyzer, 2-Channel Ratio Function.

Figure 110 shows a conceptual block diagram of the **Audio Analyzer** with the **2-Channel Ratio** function selected.

The **2-Ch Ratio** function displays the ratio of the signal amplitudes in the two channels, A and B. The Channel A Function meter shows the ratio A/B, and the Channel B Function meter shows the ratio B/A.

2-Ch Ratio may be expressed in %, dB, or X/Y units. The **2-Ch Ratio** function is useful while balancing stereo channels, for example; or for measuring gain or loss by connecting the **Audio Analyzer** A channel across the DUT input and the B channel across the DUT output.

Crosstalk Function

Figure 111 shows a conceptual block diagram of the Audio Analyzer with the **Crosstalk** function selected.

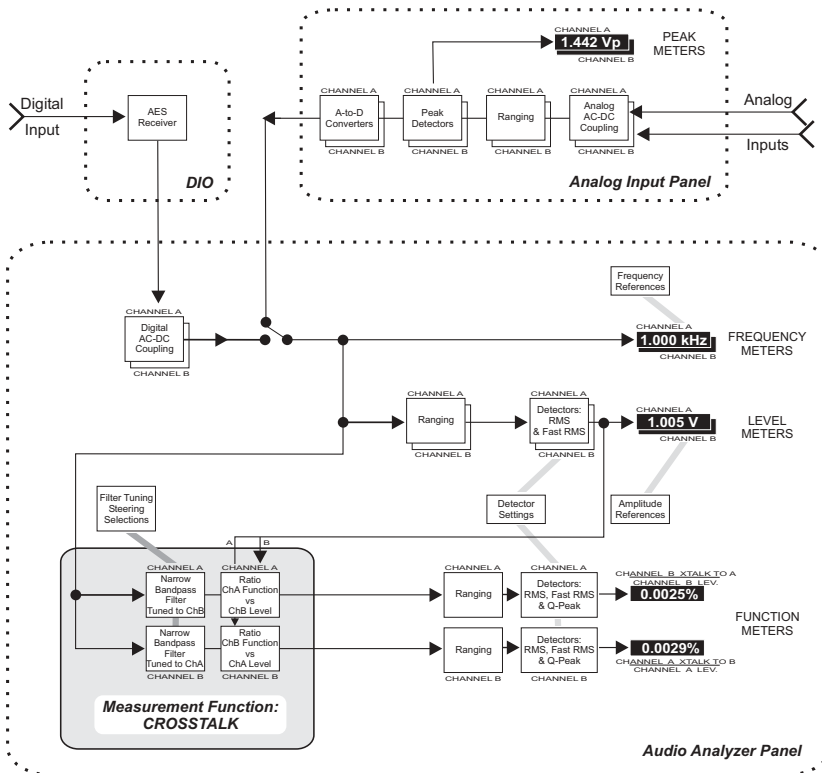

Figure 111. Conceptual Block Diagram, Audio Analyzer, Crosstalk Function.

The **Crosstalk** function measures the leakage, or crosstalk, of a sinewave from one channel to the other. A typical crosstalk test uses a stereo stimulus, with each channel driven with a sinewave of different frequency.

For each analyzer channel, a bandpass filter is steered to the frequency in the opposite channel. The amplitude measured at this frequency is the

absolute crosstalk value. The percentage of the opposite channel's signal amplitude (as measured by the **Level** meter) represented by the absolute crosstalk value of the channel under consideration is displayed in the channel's function meter.

For example, consider a stimulus with a 1 kHz sinewave on Channel A and a 2 kHz sinewave on Channel B. In the Audio Analyzer, the Channel A bandpass filter is steered to 2 kHz, a measurement is made, and the percentage of the Channel B Level meter reading this crosstalk measurement represents is computed and displayed in the Channel A Function meter display.

Likewise, the Audio Analyzer Channel B bandpass filter is steered to 1 kHz, a measurement is made, and the percentage of the Channel A Level meter reading this crosstalk measurement represents is computed and displayed in the Channel B Function meter display.

Crosstalk is a ratio, expressed as:

$$\text{Crosstalk from B into A} = \frac{\text{Level of } F_1 \text{ in A}}{\text{Level of } F_1 \text{ in B}}$$

When only one channel is driven, a **Crosstalk** percentage reading for the driven channel will display absurdly high percentages, since the denominator of the fraction (the un-driven channel level) is very close to zero. Also, since the source of the denominator is a Level meter, which is unfiltered, spurious frequencies may produce erroneous **Crosstalk** ratios. In this case, a pre-analyzer filter may be useful.

Crosstalk may be expressed in **%**, **dB**, or **X/Y** units. The Channel A Function meter shows the percentage of the signal crossed from B into A, and the Channel B Function meter shows the percentage of the signal crossed from A into B.

Since the bandpass filter will reject most wide-band noise, the **Crosstalk** function provides more accurate measurements of low-amplitude signals in the presence of noise. The filter must be tuned to the frequency of the signal on the opposite channel; see **BP/BR Filter Tuning** on page 149.

The **BW** (high-pass and low-pass) and **Fltr** (weighting) filter selections are not available for the **Crosstalk** function.

THD+N Functions

The two THD+N (total harmonic distortion plus noise) functions use bandreject (notch) filters to remove the fundamental sinewave signal so that the detector can measure the remaining harmonic distortion products and noise.

The bandreject filter center frequencies may be fixed, or may track one of several parameters. See **BP/BR Filter Tuning** on page 149.

Figure 112 shows a conceptual block diagram of the **Audio Analyzer** with the **THD+N** functions selected.

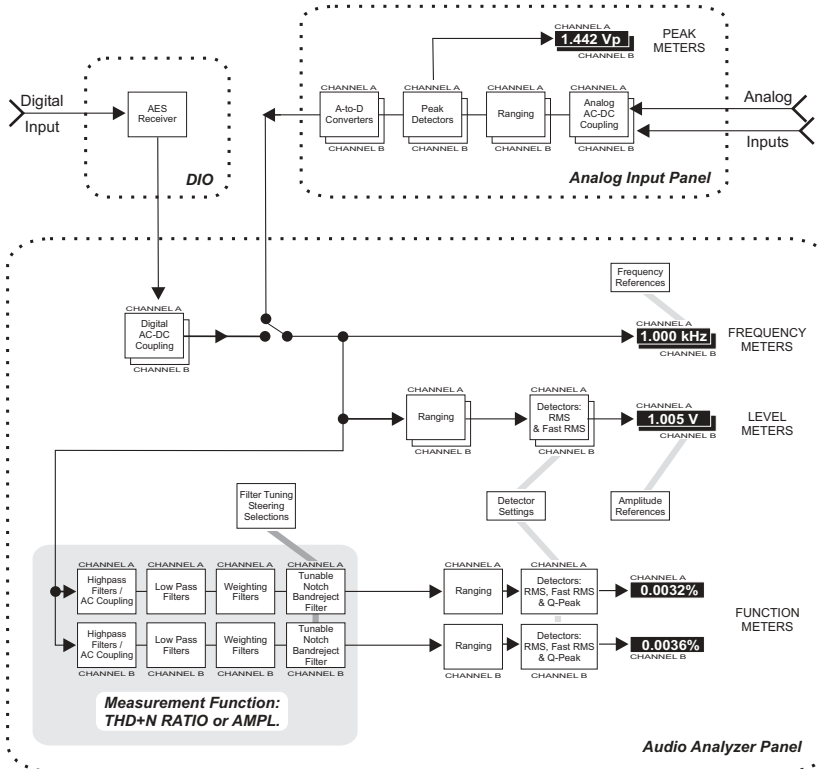

Figure 112. Conceptual Block Diagram, THD+N Functions.

THD+N Ratio Function

The **THD+N Ratio** function expresses the sum of the distortion products and noise amplitudes relative to the amplitude of the unfiltered signal (as measured by the **Level** meter); in other words, the result is a THD+N-to-signal ratio. Units of **%** and **dB** (decibels below the fundamental) are ordinarily used with the **THD+N Ratio** function.

THD+N Ratio is the common way to express distortion. However, in an amplitude sweep **THD+N Ratio** appears to show increasing distortion and noise with decreasing signal amplitude because the distortion and noise is stated as a ratio to the decreasing signal. The **THD+N Ampl** function may be more useful for amplitude sweeps.

Results using the **THD+N Ratio** function may be expressed in %, dB, or X/Y units.

THD+N Amplitude Function

The **THD+N Ampl** (amplitude) function expresses the amplitude of the distortion products and noise in absolute units, independent of the amplitude of the fundamental signal. Although the previous function, **THD+N Ratio**, is used much more commonly, **THD+N Ampl** is particularly useful when performing amplitude sweeps of audio devices, since it helps make clear that the noise component is at a constant amplitude and is unrelated to the signal amplitude.

When using the **THD+N Ampl** function the list of units and their references for both analog and digital signals are the same as described above in the **Level Meter Units** topic on page 126.

Bandpass Function

The **Bandpass** function is a selective voltmeter (a function sometimes called a *wave analyzer*) implemented by DSP techniques. Each channel includes a narrow bandpass filter of approximately 1/13 octave ($Q=19$, -3 dB bandwidth approximately 5.2% of center frequency). The bandpass filter center frequency may be fixed, or may track one of several parameters. See **BP/BR Filter Tuning** on page 149.

Figure 113 shows a conceptual block diagram of the **Audio Analyzer** with the **Bandpass** function selected.

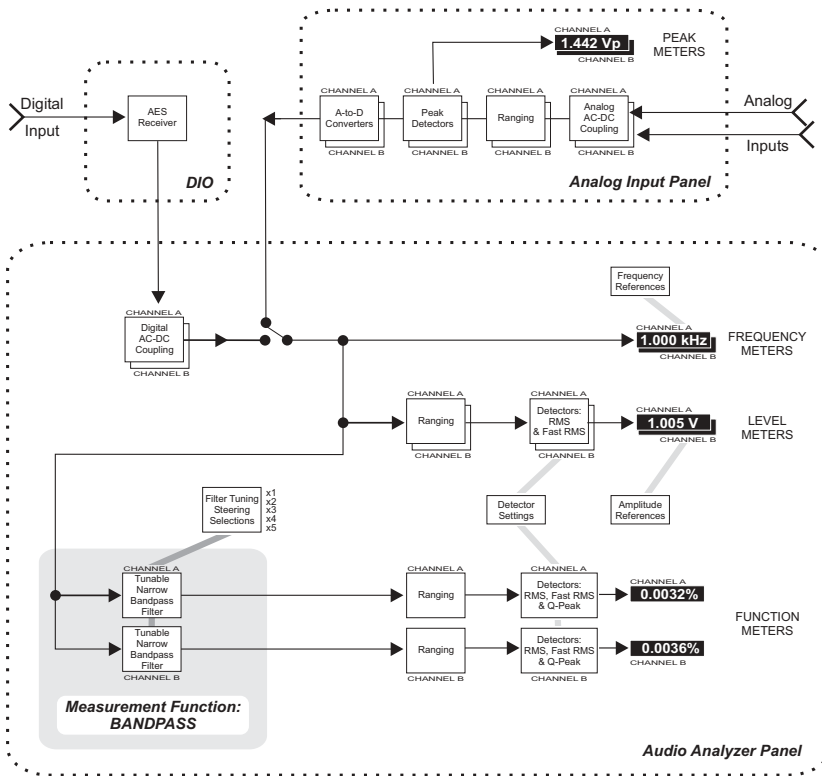

Figure 113. Conceptual Block Diagram, Bandpass Function.

The filter may be tuned to the steering source fundamental frequency or to its 2nd, 3rd, 4th, or 5th harmonic. This harmonic tracking ability permits swept measurements of individual harmonic distortion products, limited in frequency to a maximum value of 47% of the sample rate.

The **BW** (high-pass and low-pass) filter selections are not available for the **Bandpass** function.

SMPTÉ/DIN IMD Function

Figure 114 shows a conceptual block diagram of the Audio Analyzer with the **SMPTÉ IMD** function selected.

SMPTÉ IMD (intermodulation distortion to the SMPTÉ or DIN standards) measures the amplitude of the IMD residuals created below the high-frequency component of a two-tone test signal. These are recovered by first passing the signal through a 2 kHz high-pass filter and then demodulating and filtering the sidebands. Appropriate two-tone test signals can be generated by the Analog or the Digital Generator. The combined ampli-

tude of the recovered sidebands is stated as a ratio to the amplitude of the high-frequency tone, with units of % or **dB** being the most common.

The **BW** (high-pass and low-pass) filter selections are not available for the **SMPTE/DIN** function.

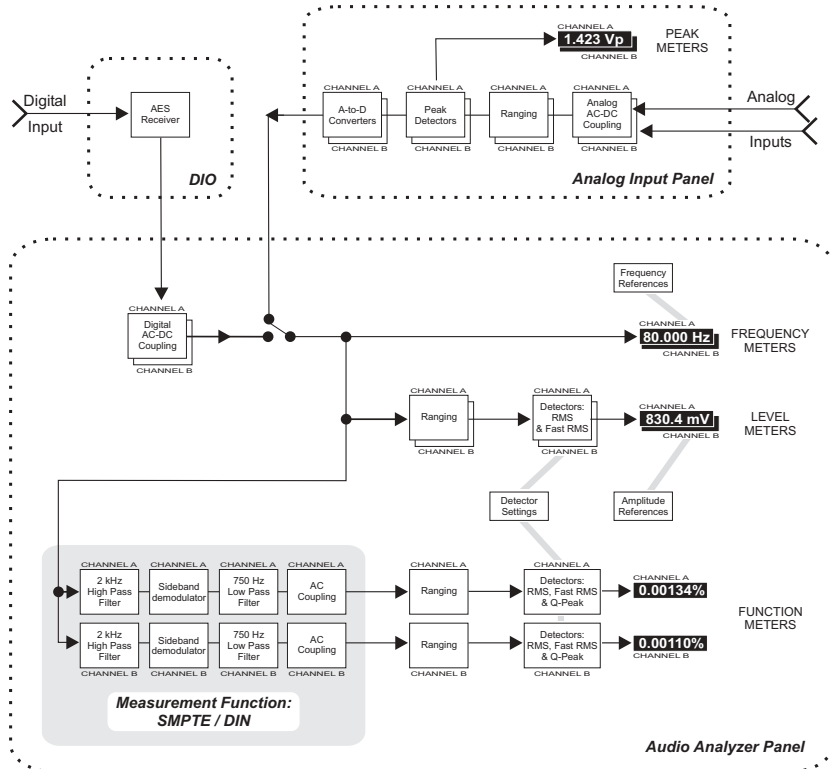

Figure 114. Conceptual Block Diagram, SMPTE / DIN Function.

Phase Function

Figure 115 shows a conceptual block diagram of the **Audio Analyzer** with the **Phase** function selected.

The **Phase** function measures the phase difference between the signals (which must be the same frequency) on the two input channels. The phase difference, always expressed in degree units, is shown in the left-hand **Function** meter display.

The value displayed is “phase B–A,” the same expression used for the **Sine: Var Phase** waveforms of the Digital and Analog Generators. If Channel B leads Channel A, the display will show a positive reading; if Channel B lags Channel A, the display will show a negative reading.

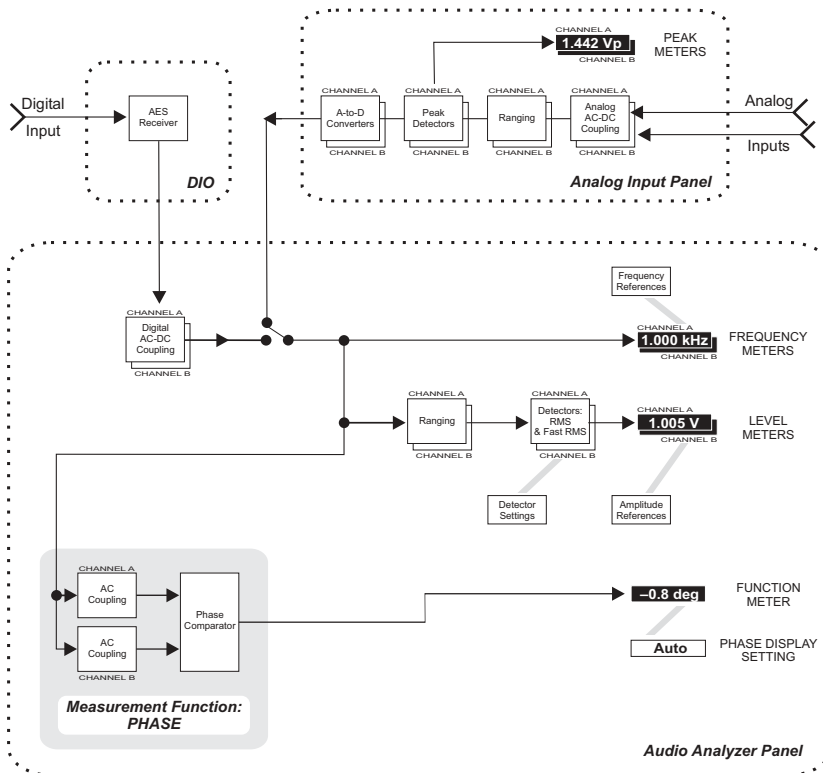

Figure 115. Conceptual Block Diagram, Phase Function.

When using **Phase**, the right-hand **Function** meter display becomes a setting field, with a list of four options: **Auto**, **-180+180 deg**, **0+360 deg**, and **-90+270 deg**.

In **Auto**, ATS reads absolute phase error. Delays in the DUT can cause signals to lag or lead by many waveform cycles, and for swept measurements **Auto** will correctly show and plot readings well beyond ± 360 degrees. When viewing phase error in **Auto** without sweeping, the reading is reset at each waveform cycle and the phase error will always be displayed as less than ± 360 degrees.

The **-180+180 deg**, **0+360 deg**, and **-90+270 deg** choices express the phase error in “windows” of 360° , with the window for each selection placed along a scale at a different positions in relation to 0° . See Figure 116.

The **BW** (high-pass and low-pass) filter selections are not available for the **Phase** function.

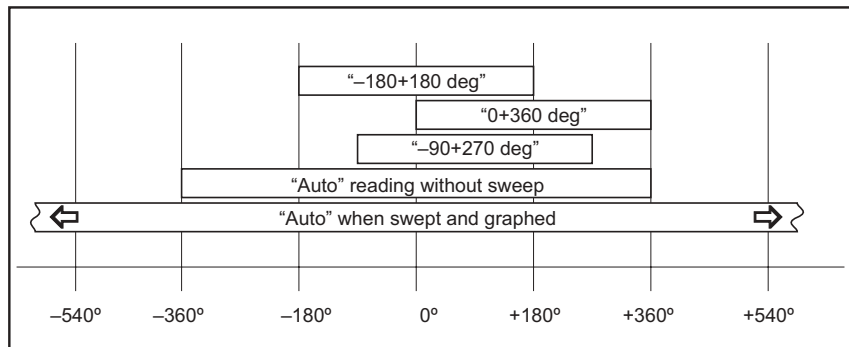

Figure 116. Audio Analyzer phase display modes.

Function Meter Units

As with the Level meters, the units available for the Function meters depend upon whether the **Analyzer Input** is set to **Digital** or **Analog**. The measurement function you choose for the **Function** meters will change the unit options as well.

- In the amplitude measurement functions (**Amplitude**, **THD+N Amplitude**, and **Bandpass**), the analog input and digital input units and their references are exactly as described above under **Level Meter Units** on page 126.
- In the various ratio-measurement functions (**2-Channel Ratio**, **Crosstalk**, **THD+N Ratio**, and **SMPTE IMD**), the available units are %, **dB**, and **X/Y**, independent of whether **Analog** or **Digital** input is selected.
- In **Phase** function, the only unit available is degrees.

For an explanation of the units of measurement used in ATS and the references for the relative units, go to **Units of Measurement**, Chapter 1.

Function Meter Ranging

Like the **Level** meters, the **Function** meters have a set of amplitude ranging controls, which are located lower on the Audio Analyzer panel beneath the Function meter reading fields.

The **Function** meter ranging controls operate in exactly the same manner as the **Level** meter ranging controls, which are discussed in detail on page 129.

Detector Type

Figure 117. The Audio Analyzer
Detector selections.

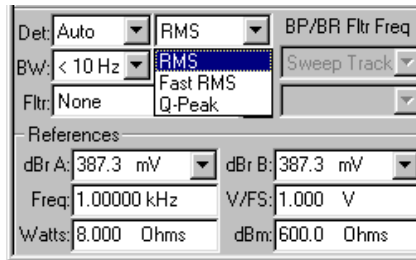

The right-hand field following the “**Det**” label permits selection of detector type for the **Function** meter of the Audio Analyzer. The available selections are **RMS**, **Fast RMS**, and **Quasi-Peak**.

*Note: These choices also affect the **Level** meters. When either rms detector is selected for the **Function** meters, the Level meters use the same type of detection. When **Quasi-Peak** is selected for the Function meters, the Level meters use normal **RMS** detection.*

Detectors and Crest Factor

3.5000 VDC is always 3.5000 VDC. But AC voltages, by definition, are always changing. We must agree to measure AC (including audio signals) in a way that is consistent and appropriate for the use at hand. Historically, AC was simply rectified with a diode (a detector, in radio terms) for measurement. But what kind of a detector? Half-wave? Full-wave? How quickly should our detector respond? How long do we gather signal before we report the voltage?

As time went on, standard AC measurement terms including “peak,” “peak-to-peak,” “average” and “rms” were agreed upon. For many purposes, rms (root mean square) AC measurements were often the most useful, especially for audio work.

The decision to use one or another detector is dependent on what aspect of an audio signal you are interested in measuring. Different detectors, and signals with different crest factors, will give you different results.

Crest factor is the ratio of a signal’s peak amplitude to its rms amplitude. Crest factor is a term describing, in simple terms, how “peaky” or “smooth” a waveform is. A signal with many large, narrow transients (such as Gaussian white noise) has a high crest factor; a consistent waveform (such as a flute tone) has a low crest factor.

■ RMS

The **RMS** choice provides conventional true rms detection with a measurement time approximately the reciprocal of the selected reading rate.

■ Fast RMS

The **Fast RMS** selection provides synchronous rms detection for periodic signals such as sinewaves and squarewaves, making accurate measurements in as little as one cycle of signal. **Fast RMS** is useful for very rapid frequency response sweeps.

The measurement period is synchronized with zero crossings of the signal waveform and will always be an integer number of signal cycles. The actual measurement time is the reciprocal of the detector reading rate value plus the time necessary for completion of the cycle of signal in progress when the reading rate period expires. For example, if the reading rate is set to **64/s** (a period of 15.6 ms) and the signal being measured is a 500 Hz signal (which has a 2 ms period), the total time of each measurement could vary between 15.6 ms to almost 17.6 ms, depending on the phase of the signal.

- **Quasi-Peak** provides a response conforming to the IEC468 specification for noise measurements, and is normally used with the CCIR (IEC468) weighting filter.

Detector Reading Rate

Figure 118. The Audio Analyzer Reading Rate selections.

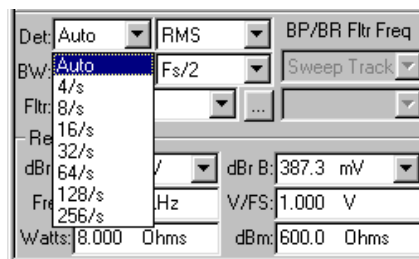

The left-hand field following the “**Det**” label controls the detector reading rate, the rate at which all the Audio Analyzer meters update. This is also called *integration time*. The selections are **Auto**, **4/s**, **8/s**, **16/s**, **32/s**, **64/s**, **128/s**, and **256/s**.

The actual measurement time for a given selection depends on the detector response type selected. For **RMS** and **Quasi-Peak**, the measurement time will be approximately the period of the selected rate (for example, about 125 ms at 8/s). For the **Fast RMS** detector, the rate selected will set the minimum measurement period. The actual period may

be longer, since with **Fast RMS** the measurement continues until the next positive-going zero crossing of the signal cycle.

Normally, **Auto** will be your best choice, with the most important exception being noise measurements, discussed below. The **Auto** algorithm takes into account the signal frequency being measured and whether or not the bandpass filter is in use, and then selects the fastest reading rate which will deliver the specified accuracy under these conditions.

For noise measurements, the **4/s** selection is recommended to provide integration of noise over a longer period. You might also choose **4/s** when measuring periodic waveforms for the best accuracy and repeatability at very low frequencies.

The **8/s**, **16/s**, **32/s**, **64/s**, **128/s**, and **256/s** choices provide progressively faster measurements. If you are watching a bargraph display while making adjustments to a DUT, for example, the faster rates better approximate real-time readings and will give you better feedback.

However, low-frequency measurement accuracy is reduced at faster rates. Each step faster in reading rate raises the low-frequency limit to accurate measurement. Faster reading rates are also less tolerant of noise in the signal.

The Bandwidth and Filter Fields

Beneath the detector fields are three fields which allow selection of various filter options for the **Function** meters. The first two are labeled “**BW**” for bandwidth, and consist of highpass and lowpass filter options. The third field is labeled “**Filtr**” and provides weighting filter selections for some instrument functions and detailed control over the bandpass/bandreject filters for other functions. Graphs of all the filter curves are shown in the Specifications chapter in *Getting Started with ATS-2*.

BW: The Highpass Filter

Figure 119. The Audio Analyzer
BW: Highpass Filter.

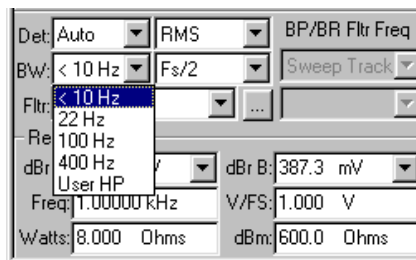

There are two **BW** (bandwidth) filter control fields. The left field is the highpass field.

The highpass filter is effective in all **Function** meter functions except **Crosstalk, Bandpass, SMPTE** and **Phase**. This field allows you to select essentially flat response at low frequencies (the **<10 Hz** selection), specific highpass filters at **22 Hz, 100 Hz, 400 Hz**, or a **User HP**. A highpass filter, when selected, is connected in the measurement paths of both **Function** meter channels, but does not affect the **Level** or **Frequency** meters.

The 22 Hz and 100 Hz high-pass filters are four-pole (24 dB/octave) designs in all functions of the **Function** meter.

In the two **THD+N** functions, the 400 Hz filter also is four-pole; however, in the **Amplitude** or **2-Ch Ratio** functions, the 400 Hz filter becomes an extremely sharp, high-rejection ten-pole elliptical high-pass filter. Selecting the 400 Hz filter in these functions permits quantization noise and distortion measurements of ADCs and digital systems.

You can also use a custom highpass filter file by selecting **User HP**. See **User Filters**, page 147.

BW: The Lowpass Filter

Figure 120. The Audio Analyzer
BW: Lowpass Filter

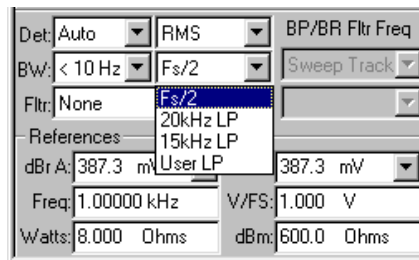

The right **BW** (bandwidth) filter control field is the lowpass field.

The lowpass filter is effective in all **Function** meter functions except **Crosstalk, Bandpass, SMPTE** and **Phase**. This field allows you to select essentially flat response at high frequencies (the **Fs/2** selection), specific lowpass filters at **20 kHz, 15 kHz**, or a **User LP**. *F_s* refers to the currently selected sample rate, as determined in the settings in the DIO panel for digital signals; or in the Analog Input panel for analog signals. Any lowpass filter, when selected, is connected in the measurement paths of both **Function** meter channels, but does not affect the **Level** or **Freq.** meters.

The 20 kHz and 15 kHz lowpass filters are six-pole elliptic designs.

Selection of a 15 kHz or 20 kHz lowpass filter when making THD+N measurements is particularly important in measuring converters with large amounts of noise shaping.

Performance of the 15 kHz and 20 kHz lowpass filters is independent of sample rate at sample rates above approximately 44 kHz. As sample rates decrease toward twice the corner frequency of the selected filter, it essentially becomes the same as the $F_s/2$ selection.

You can also use a custom lowpass filter file by selecting **User LP**. See **User Filters**, page 147.

The "Filtr" Field

The field labeled "**Filtr**," just beneath the bandwidth filter fields, has different operations in different functions of the Function meter.

- In the **Amplitude**, **2-Ch Ratio**, and the two **THD+N** functions, this field allows selection of weighting filters, as discussed below.
- In the **Bandpass** function, the field permits selection of whether the bandpass filter is tuned to the fundamental frequency of the source being tracked, or to the 2nd, 3rd, 4th, or 5th harmonics. See **BP/BR Filter Tuning** on page 149.
- In the **Crosstalk**, **SMPT/DIN** and **Phase** functions, the field disappears.

Filtr: Weighting Filters

Figure 121. The Audio Analyzer *Filtr* selections.

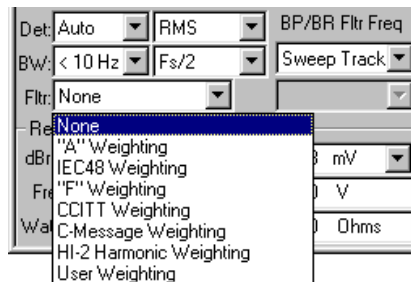

Weighting filters provide response curves which are relevant to the characteristics of human hearing. Weighting filters are frequently required for meaningful noise measurements and sometimes for THD+N as well. Standards often specify weighting filters for measurements. See the **Specifications** chapter in *Getting Started with ATS-2* for graphs of the filter curves.

Several selections are provided in the weighting filter field—**None**, **"A" Weighting**, **CCIR Weighting**, **"F" Weighting**, **CCITT Weighting**,

C-message Weighting, HI-2 Harmonic Weighting and User Weighting Filter. When any of these weighting filters is selected, it affects the **Function** meter measurement paths of both channels. The **Level** and **Frequency** meters are always unfiltered.

- **None** applies no weighting filter.
- **“A” Weighting** processes the signal through a psophometric weighting filter meeting the ANSI A-weighting specification. An A-weighting filter in combination with the THD+N function is frequently used for dynamic range measurements of ADCs.
- **CCIR Weighting** processes the signal with the weighting filter described in IEC468. It is normally used in one of two ways:
 - When used with an rms detector, this filter produces measurements in accordance with the Dolby Labs CCIR/ARM method.
 - When used with the **Q-Peak** detector at a reading rate of **4/s**, this filter produces measurements satisfying the IEC468 standard.

*The IEC468 standard specifies that the unity gain point in the test intersect the weighting curve at 1 kHz, rather than the 2 kHz intersection specified for the Dolby Labs CCIR/ARM method. ATS automatically makes the 6 dB level adjustment to accomplish this when **IEC468 Weighting and Q-Peak** are selected together.*

- The **“F” Weighting** filter is based on psychoacoustic research and relates to typical human hearing sensitivity at a sound pressure level of 15 phons.
- **CCITT Weighting** and **C-message Weighting** filters are essentially voice-band filters sometimes required for telecommunications applications.
- The **HI-2 Harmonic Weighting** filter is available as a selection only when the **Function** meters are in **THD+N Ratio** or **THD+N Amplitude** functions. The primary purpose of the **HI-2 Harmonic Weighting** filter is for rub and buzz measurements on loudspeakers. This filter has a rising 12 dB/octave response with the unity gain frequency four times higher than (two octaves above) the frequency of the THD+N notch filter, which means it emphasizes the effect of signals above the fourth harmonic and reduces the effect of signals below the fourth harmonic. Maximum gain of the **HI-2 Harmonic Weighting** filter is limited to 28 dB.
- **User Weighting** provides a way to insert a custom weighting filter into the **Function** meter paths. See **User Filters**, below.

The A, IEC468, and F weighting filters are specified to 20 kHz; at sample rates below 44 kHz, their response within a few kilohertz of $F_s/2$ will deviate from specification.

Weighting filter responses are perfectly accurate at the following sample rates:

Sample rates that produce precise filter responses.		
32.000 kHz	65.536 kHz	131.072 kHz
44.100 kHz	88.200 kHz	176.400 kHz
48.000 kHz	96.000 kHz	262.144 kHz

At any other sample rate, the filter shape is preserved but the filter “slides” up or down in frequency by the ratio of the actual sample rate in use to the nearest sample rate from the list above.

User Filters

User downloadable filters (or *user filters*), are custom-designed software filters which can be designed for use in any of the three **Audio Analyzer** filter groups.

You can select a user downloadable filter for the **Audio Analyzer** in the same way that you choose one of the standard DSP filters.

The low-pass and high-pass filters are selected in the two fields to the right of the **BW** (bandwidth) designation. The weighting filters are selected in the **Filtr** (filter) field.

*DSP filters are not available in every measurement function of the **Audio Analyzer**. Set the **Function** meter function to **Amplitude**, **2-Channel Ratio** or one of the two **THD+N** modes to choose DSP filters.*

Click the arrow to drop down the list of filters for any of these fields. The last filter option on all lists selects the downloadable filter type appropriate for that setting: **User HP**, **User LP** or **User Weighting Filter**.

Although you can save many different user filter files for use in ATS, you can only select one user file for each of the three filter positions at any one time. When ATS is launched, by default no user filter files are selected. To choose your filters, click the browser button to the right of the **Filtr** field. A file browser opens that enables you to select filter files for any of the three filter types: low-pass, high-pass and weighting. You can also view the filter **Info** string for any of the three selected filters.

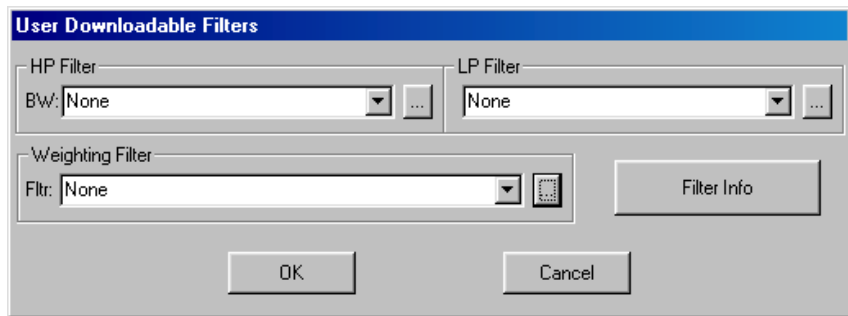

Figure 122. The **Audio Analyzer User Filter** file browser.

When you have chosen downloadable filters and closed the browser, notice that the **BW** and **Filtr** fields have been automatically set to **User** to reflect your choices. As long as you do not exit the ATS control software or load a test file, these downloadable filter files will remain attached to their filter lists. You still have the option, however, of choosing other ATS-provided filters (or **None**) from the lists without losing the link to the file you have selected.

A test saved with an attached user filter will re-attach the filter to the **Audio Analyzer** when the test is loaded.

If you select **User** from any of the three filter lists and a user filter file has not been previously selected for that setting, the user filter file browser will appear and prompt you to choose a filter file.

User filter files created to a number of specifications are provided on the Audio Precision Resources Disc, and are also available for download from our Web site at ap.com.

Audio Precision provides a utility program called FDP as a download from our Web site at ap.com as an aid to creating your own downloadable filters.

Several Matlab functions are also available on the Audio Precision Resources Disc and on the Web site, which will be helpful to Matlab users in creating properly-formatted downloadable filter files use with ATS. See Appendix D for more information.

Bandpass/Bandreject Filter Tuning

Figure 123. The Audio Analyzer BP/BR Filter Selections.

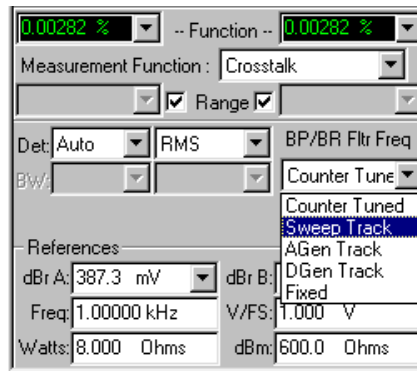

The **BP/BR Fitr Freq** (bandpass/bandreject filter frequency) controls affect only the **Function** meters, and only in certain functions, as listed below. The filter does not affect the **Level** meter or **Freq.** counter readings.

The bandpass filter is a highly selective filter of approximately 1/13 octave bandwidth. $Q=19$, giving a -3 dB bandwidth of 5.2% of the center frequency. The filter is tunable across the audio spectrum from 0.04% to 42% of the sample rate (20 Hz to 20 kHz at a 48 kHz sample rate).

The bandpass or peaking form of the filter is used in two **Audio Analyzer** functions:

- **Crosstalk** and
- **Bandpass.**

The bandreject or notch form of the filter is used in two other **Audio Analyzer** functions:

- **THD+N Ratio** and
- **THD+N Ampl.**

Either the bandpass or bandreject form of the filter may be fixed in frequency, or may be “steered” to automatically track a parameter during a sweep test. You can select the source of frequency steering information in the **BP/BR Filter Freq** field, located in the lower-right area of the **Audio Analyzer** panel. The selections are:

- **Counter Tuned**
- **Sweep Track**
- **AGen Track**
- **DGen Track** and

■ Fixed.

When the **Audio Analyzer** is using the **Bandpass** function, you can further modify the filter steering source value by changing the setting in the “**Fltr**” field, located beneath the **BW** (bandwidth) setting fields. See **Selecting Harmonics in Bandpass** on page 150.

- When **Counter Tuned** is selected, the frequency value measured by the **Frequency** counter becomes the filter steering source. You would use this when making **THD+N** or **Crosstalk** measurements from an external signal such as playback of a compact disc or reception of a signal from a distant source.
- When **Sweep Track** is selected, the filter tracks the frequency of whichever generator is selected in the **Source 1** or **Source 2** fields of the Sweep panel.
- When **AGen Track** is selected, the filter tracks the frequency of the Analog Generator. This mode is useful for testing ADCs driven from ATS-2’s analog output.
- When **DGen Track** is selected, the filter will automatically track the frequency of the Digital Generator. This mode is normally used when sweeping input-to-output through a digital device with the stimulus tone coming from ATS-2’s Digital Generator.
- When **Fixed** is selected, the field immediately below (which is grayed out in other modes) becomes active. The filter will be set at the frequency entered in this field.
It is also possible to vary the filter frequency in this mode as part of a sweep test. Although this is similar to the **Sweep Track** choice above, in this case the filter can be swept independent of generator frequency.
To sweep the filter frequency during a test, first be sure you have selected **Fixed** in the **BP/BR Filter Freq** field here on the Analyzer panel.

Fltr: Selecting Harmonics in Bandpass

In **Bandpass** function, the **Fltr** field offers the selections of **Narrow**, **Narrow, Freq x2**, **Narrow, Freq x3**, **Narrow, Freq x4**, and **Narrow, Freq x5**.

Figure 124. The **Audio Analyzer** **Narrow Fltr** harmonic selections.

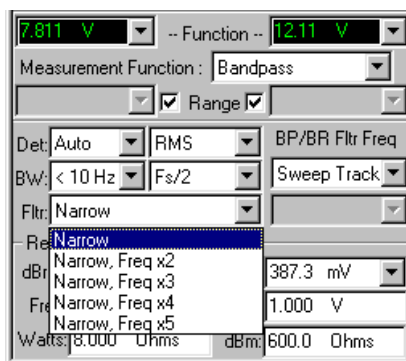

The default setting, **Narrow**, sets the filter at the source frequency. The other choices (**Narrow, Freq x2**; **Narrow, Freq x3** and so on) move the filter to multiples of the source frequency, allowing you to make individual harmonic distortion measurements of the 2nd through 5th harmonic.

The filter bandwidth is fixed at the normal 5.2% bandwidth value under all of these selections, but its center frequency is steered to different integer multiples of the **BP/BR Source** steering frequency. See **BP/BR Filter Tuning** on page 149.

References

The bottom area of the **Audio Analyzer** panel includes six fields (with **Input: Analog**) or four fields (**Input: Digital**) in which you can enter reference values. Each reference serves as a basis for its corresponding unit of measurement on the panel. The **Freq.** and **V/FS** references are the same for both the **Analog** and **Digital** inputs; the other reference fields will change with the input configuration.

Analyzer Analog References

Figure 125. **Analyzer** **Analog** References.

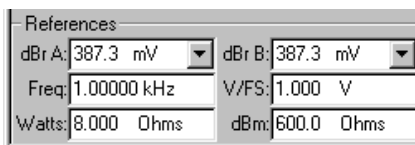

■ **dBr A** and **dBr B**

When the **Analyzer Input** is set to **Analog**, the **dBr A** and **dBr B** values serve as the analog references for the **dBr A** and **dBr B** units selectable at any meter measuring amplitude.

■ **Freq**

The frequency (**Freq**) value serves as the reference for the relative

frequency units (**octs**, **decs**, **% Hz**, etc.) of **Analyzer** frequency meters.

■ **V/FS**

In some setups when ATS-2 is measuring a signal in one domain (digital or analog), you may find it more convenient to enter or view the equivalent of the signal in the other domain. The **V/FS** (volts for full scale) value is the analog-to-digital scaling value.

When testing an external ADC, for example, enter the value of analog input voltage that produces digital full scale output into this field. Then you can select amplitude meter units as **V**, **Vp**, **Vpp**, **dBu**, or **dBV** to express the measured digital amplitude in terms of the analog input value to the converter.

In the same way, the **dBr A** and **dBr B** reference values may also be entered as digital or analog domain units, with the **V/FS** reference value being used to scale the references.

■ **Watts**

The **watt** is a unit of power, not voltage. Since power calculations are dependent on the circuit impedance, the load impedance encountered in your test must be entered as a reference for accurate display of **watts (W)** measurements. 8Ω is the default impedance for the **watts** reference.

■ **dBm**

The **dBm**, like the **watt**, is a unit of power (decibels relative to 1 mW). Since power calculations are dependent on the circuit impedance, the load impedance encountered in your test must be entered as a reference for accurate display of **dBm** measurements. 600Ω is the default impedance for the **dBm** reference.

*dBm is rarely the correct choice of units for audio measurements. dBm units are often mistakenly chosen when dBu units should be used. See the sidebar **dBm versus dBu** on page 375.*

Analyzer Digital References

Figure 126. *Analyzer Digital References*



■ **dBr A** and **dBr B**

When the **Analyzer Input** is set to **Digital**, the **dBr A** and **dBr B**

values serve as the digital references for the **dBr A** and **dBr B** units selectable at any meter measuring amplitude.

- **Freq**

The frequency (**Freq**) value serves as the reference for the relative frequency units (**octs**, **decs**, **% Hz**, etc.) of **Analyzer** frequency meters.

- **V/FS**

In some setups when ATS-2 is measuring a signal in one domain (digital or analog), you may find it more convenient to enter or view the equivalent of the signal in the other domain. The **V/FS** (volts for full scale) value is the analog-to-digital scaling value.

When testing an external ADC, for example, enter the value of analog input voltage that produces digital full scale output into this field. Then you can select amplitude meter units as **V**, **Vp**, **Vpp**, **dBu**, or **dBV** to express the measured digital amplitude in terms of the analog input value to the converter.

In the same way, the **dBr A** and **dBr B** reference values may also be entered as digital or analog domain units, with the **V/FS** reference value being used to scale the references.

Chapter 11

The Spectrum Analyzer

Figure 127. The **Spectrum Analyzer** panel.

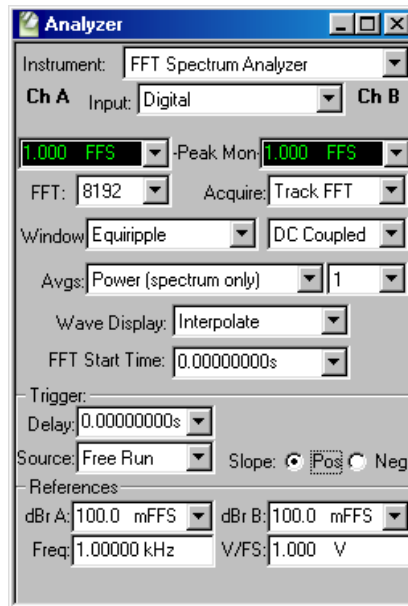

Introduction

The **Spectrum Analyzer** is a DSP instrument selection on the Analyzer panel. It is named “**FFT**” on instrument browser lists and in OLE references.

The **Spectrum Analyzer** is a general-purpose waveform display and spectrum analyzer for ATS-2. It provides both

- time domain (oscilloscope) display of waveforms, and
- frequency domain (spectrum analyzer) views.

The **Spectrum Analyzer** can analyze and display analog input signals up to 120 kHz (with the optional high bandwidth ADCs) and digital signals up to 108 kHz.

Features include large, dedicated memory buffers, flexible triggering, averaging techniques, waveform processing, selectable display methods, a wide choice of FFT windowing functions, and the capability of shifting a sinewave signal to a bin center for synchronous analysis.

This chapter examines each function, control and display of the **Spectrum Analyzer** in detail. If you are new to ATS-2, you might want to start with the Quick Guides in *Getting Started with ATS-2*, which will introduce you to **Spectrum Analyzer** features.

See **Appendix C** for a conceptual overview of FFTs.

Loading the Spectrum Analyzer

Figure 128. Loading the **Spectrum Analyzer**.

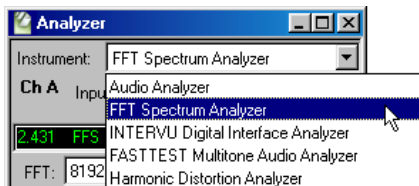

To use the **Spectrum Analyzer**, first open the Analyzer panel. The Analyzer panel is a command selection on the Panel menu, and is also available by the keyboard shortcut **Ctrl+Y**, or by clicking the **Analyzer** icon on the Toolbar.

Now select **FFT Spectrum Analyzer** from the list on the Analyzer panel. This loads the Spectrum Analyzer program into DSP.

Signal Inputs

Figure 129. **Spectrum Analyzer** panel inputs.

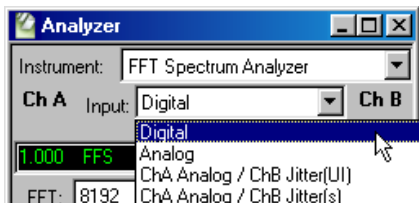

The **Input** field of the **Spectrum Analyzer** offers four signal input selections:

- **Digital.**

- **Analog.**

These two choices access the signals routed from the Digital Input/Output (DIO) panel or the Analog Input panel, respectively.

- **ChA Analog/ChB Jitter (UI).**

- **ChA Analog/ChB Jitter (s).**

These two choices apply the Channel A signal from the Analog Input panel to the **Spectrum Analyzer** Channel A input, and the jitter signal from the DIO to the Channel B input. The only difference between the two choices are the units selected for the jitter measurements, unit intervals (UI) or seconds.

Digital signals are applied directly to the **Spectrum Analyzer** DSP; analog signals are first digitized by precision ADCs (selected on the Analog Input panel) before being applied to the **Spectrum Analyzer**.

To configure analog input connectors, range, coupling, select ADCs, bandwidth, and so on, go to the Analog Input panel (see Chapter 6). To configure digital input connectors, digital input format and other aspects of the interface, go to the DIO panel (see Chapter 7).

Peak Level Monitors

Figure 130. ATS Spectrum Analyzer peak level meters.

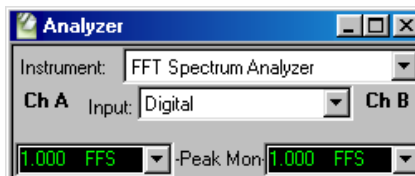

The two **Peak Mon** meters on the Spectrum Analyzer panel continuously display the peak amplitude of the digital signal as it is presented to the **Spectrum Analyzer**. Only digital domain units (**FFS**, **dBFS**, **%FS**, or **bits**) are available for these meters.

The primary purpose of the peak monitors is to avoid overload of the input analog-to-digital converters (ADCs). When signal is being acquired from the analog source and **Auto Range** is in use on the Analog Input panel, ADC overload should never be a problem. If any of the Analog Input range controls is fixed, you must verify that the maximum signal amplitude never exceeds digital full scale.

Acquiring, Transforming and Processing

The Spectrum Analyzer instrument acquires, transforms, processes and displays data in distinct steps. For a frequency domain (spectrum) view, there are three steps:

- acquiring the data,
- performing the FFT, and
- processing the results for graphing.

Often all these steps are performed in quick succession for each spectrum display. At other times, only the last step or two are performed on an acquisition or set of transform results already in memory.

For a time domain (oscilloscope) view, there are only two steps:

- acquiring the data, and
- processing the results for graphing.

Three sets of commands control the Spectrum Analyzer processes:

- **Sweep > Start / Go / F9**

These commands are all equivalent, and perform all three steps: a new acquisition is made, the data is transformed, and the results are processed for display.

- **Sweep > Transform w/o Acquire, / F6**

These two commands are equivalent, and perform the two last steps: the acquired data is transformed, and the results are processed for display. No new acquisition is made.

- **Sweep > Reprocess Data / Ctrl-F6**

These two commands are equivalent, and perform the last step: the results are processed for display. No new acquisition is made and no new transform is performed.

For the time domain view, **F6** and **Ctrl-F6** have the same result.

Making a new acquisition is usually the most time-consuming step in the process; performing the transform is next and processing the results for display is usually the fastest step. When time becomes an important consideration, as in repeated automated processes, you should take care to include only necessary FFT steps.

The Acquisition Record

Figure 131. ATS Spectrum Analyzer
Acquire selections.

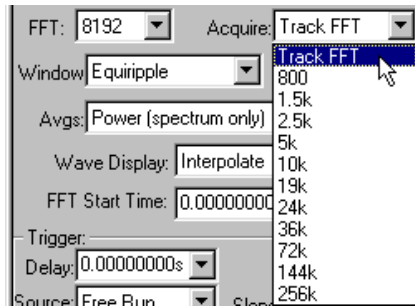

See Appendix C for a conceptual overview of FFTs, including a discussion of the acquisition record and FFT length.

In performing an FFT ATS-2 first acquires data, taking a brief sample of the signal to be analyzed. This acquired data is called the *acquisition record*, and it is stored in a location in ATS-2's DSP memory called the *acquisition buffer*. The two channels of a stereo acquisition are maintained in two separate acquisition buffers.

Acquiring the data and performing the FFT are two separate steps. You can choose to acquire new data with each execution of an FFT, or you can re-transform the same acquired data repeatedly, using different processing or timing settings with each FFT.

When using the **Spectrum Analyzer**, the **Sweep > Start (F9)** command both acquires new data and performs the FFT. Additional menu commands **Sweep > Transform data w/o Acquire (F6)** and **Sweep > Reprocess Data (Ctrl+F6)** provide you with other options. These commands are discussed in more detail on page 157.

The acquired signal may be viewed in the frequency domain by selecting **FFT.Frequency** for **Source 1** and choosing the desired **Start** and **Stop** values on the Sweep panel.

Any portion of the acquired signal may be viewed in the time domain by selecting **FFT.Time** for **Source 1** and choosing the desired **Start** and **Stop** values on the Sweep panel.

You can easily set up a new FFT and then toggle between time domain and frequency domain views using the **Sweep Spectrum/Waveform Button**, which is discussed on page 182.

Both channels of the acquired waveform remain in the DSP acquisition buffer until one of the following events occurs:

- a **Sweep > Start** (or **Go** or **F9**) command is issued to acquire new waveforms;
- a different Analyzer instrument is loaded;
- power is turned off to ATS-2; or
- a different acquisition waveform is loaded from disk as described in **Loading Acquired Waveforms** on page 185.

While the waveform is still present in the acquisition buffer, full flexibility exists to change back and forth between time and frequency domain analysis. You may view different time portions of the record, perform FFTs of different transform lengths, position the transform starting point at different places in the record, change window functions, change FFT post-processing modes, change time domain processing modes, etc. The results of any and all of these different modes of analysis may be saved as .ats2 test files.

Saving a test file, however, does not save the acquired waveform, only the test setup and results. It is possible to also save the acquired waveform, which can be reloaded at a later time for further analysis. See **Saving Acquired Waveforms** on page 183.

Acquisition Length

Set the length of the acquisition by selecting a value from the **Acquire** list. The acquisition lengths are stated in samples; the duration of the acquisition will depend on the sample rate in use. At a sample rate of 48 kHz, a 256k acquisition will have a duration of 5.46 seconds. Acquisitions can be equal to or longer than the FFT length you intend to use. A longer acquisition enables you to perform transformations at different points along the length of the acquired record.

By choosing **Track FFT**, you can set ATS-2 to acquire only the amount of data needed for the present transform length, which is set in the **FFT** field to the left. This provides faster performance compared to making longer-than-needed acquisitions. See **Transform Length**, below.

Transform Length

Figure 132. ATS FFT transform length selections.

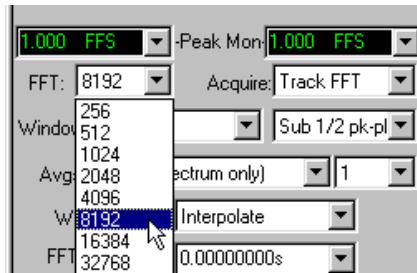

The transform length and sample rate determine the bin width (or frequency resolution) of an FFT. See Appendix C for a conceptual overview of FFTs, including a discussion of the relationship between transform length, sample rate and bin width.

Select an FFT length from the **FFT** list. Your choices are **256, 512, 1024, 2048, 4096, 8192, 16384,** and **32768** samples.

When you are performing an FFT on an acquisition record which is longer than the transform length, only the number of samples specified in the **FFT** field will be transformed.

Spectrum Analyzer Window Selection

Figure 133. ATS Spectrum Analyzer FFT Window selections.

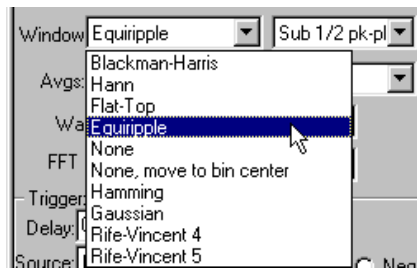

See Appendix C for a conceptual overview of FFTs, including basic information on FFT windowing.

The window selections for the Spectrum Analyzer are

- **Blackman-Harris**
- **Hann**
- **Flat-top**
- **Equiripple**
- **None**

- None, move to bin center
- Hamming
- Gaussian
- Rife-Vincent 4, and
- Rife-Vincent 5.

Each window function has a different set of trade-offs in effective selectivity and in potential amplitude measurement error.

The Hamming and Hann windows, for example, have the best selectivity near the top of the window but limited rejection of signals more distant from the center. The Blackman-Harris, Equiripple, and Rife-Vincent windows have much better rejection of more distant signals. The Flat-Top window has the poorest selectivity, but virtually no amplitude error across the center three bins.

See Figures 134 and 135 for comparison of the close-in selectivity curves of the Spectrum Analyzer FFT windowing choices.

The window function is applied after signal acquisition and before the transform, which means that you can change the FFT **Window** selection and re-transform the data using the **F6** command, without making another acquisition. You can compare the effects of several different window functions on the same signal acquisition by checking the **Append** box on the Sweep panel and using **F6** to re-transform the data with new window settings.

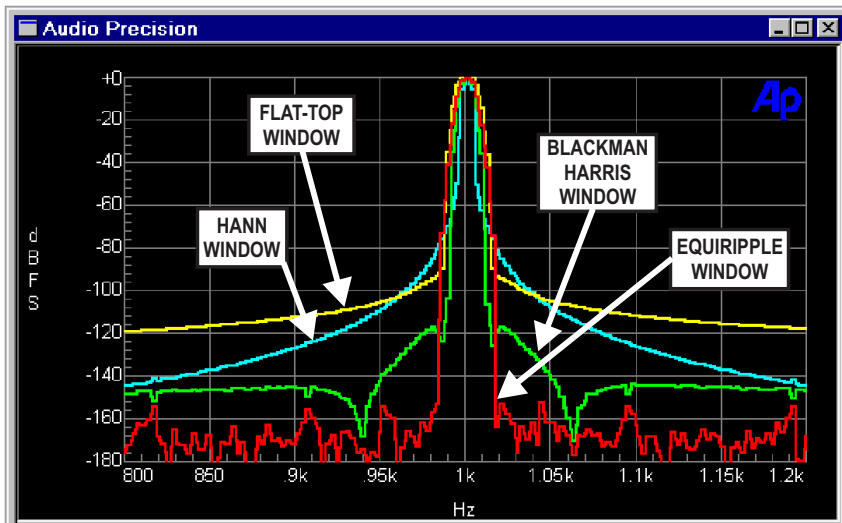

Figure 134. FFT Window Functions: Flat-Top, Hann, Blackman-Harris and Equiripple.

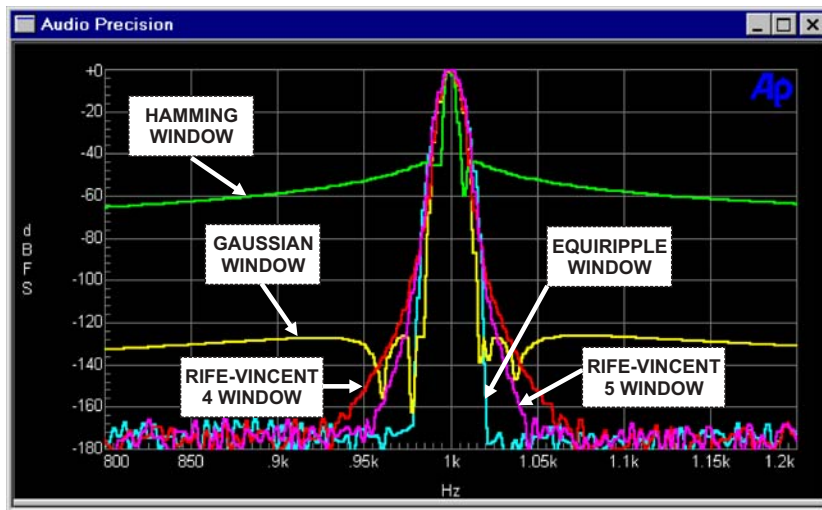

Figure 135. FFT Window Functions: Hamming, Gaussian, Rife-Vincent 4 and 5. Equiripple shown for comparison.

Hann Window

The Hann window is a raised cosine window named after its inventor, Austrian meteorologist Julius von Hann. It provides good selectivity near the top of the main lobe (about -6 dB one bin away from center and about -30 dB two bins away), with no sidelobes. Its skirts more than 3 bins off center are not as steep as the Blackman-Harris window. The Hann window causes approximately -1.5 dB maximum amplitude error due to window attenuation, if the signal is at the extreme edge of the bin.

Blackman-Harris Window

The Blackman-Harris 4-term minimum sidelobe window was developed by R. B. Blackman and F. J. Harris. Compared to the Hann window, it is not quite as selective across the central several bins (about -3 dB in the adjacent bins and about -14 dB two bins off), but has steeper skirts beyond that point. The Blackman-Harris window has sidelobes below -92 dB (response fall-off is not monotonic). It has a reasonably flat top with a maximum amplitude error of about -0.8 dB if the signal is at the extreme edge of the bin.

Flat-Top Window

The Flat-Top window is designed for the greatest amplitude measurement accuracy. It provides a maximum amplitude error due to window attenuation of less than -0.02 dB. However, its selectivity is poorer than the

other windows. The Flat-Top window is the appropriate window for accurate amplitude measurements (such as when measuring individual harmonics) except when signals are so closely spaced that its selectivity becomes a problem.

Equiripple Window

The Equiripple window, developed at Audio Precision, is an approximation to the Dolph-Chebyshev window that has the narrowest main lobe width for a given maximum sidelobe depth. The main lobe is approximately 12 bins wide; that is, the first null is about six bins from the main lobe center. The first sidelobe, which is also the highest, is -147 dB from the main lobe. The maximum amplitude error with a signal at the bin boundary is about 0.5 dB.

Hamming Window

The Hamming window has the sharpest selectivity of all the windows provided. Adjacent bins average about -7 dB and two bins away the response is about -40 dB. Amplitude error is about -1.7 dB for a signal at the extreme edge of a bin. The sidelobes of the Hamming start at only -40 dB to -50 dB below the top of the main lobe, about 4 bins away from the center bin. The response fall-off is not monotonic.

Gaussian Window

The Gaussian window main lobe width is only slightly wider than the Blackman-Harris window and the nearby rejection is considerably better than Blackman-Harris, reaching an average of -100 dB down in the fifth bin away from center. The sidelobes are down more than -130 dB, compared to about -100 dB for Blackman-Harris. Maximum amplitude error is about -0.7 dB for a signal at bin edge.

Rife-Vincent Windows

Both Rife-Vincent windows have smooth, monotonically-falling responses with no sidelobes. The Rife-Vincent 4 window has about -0.6 dB maximum amplitude error, is about -100 dB at 7 bins off center and about -150 dB at 15 bins off. The Rife-Vincent 5 is slightly wider at the top of the main lobe, with about -0.5 dB maximum amplitude error. It has sharper skirts with attenuation reaching about -106 dB at 7 bins off center and about -150 dB at 12 bins off.

None (No Window or Rectangular Window)

The **None** selection (sometimes called a rectangular window) does not apply any window function before the FFT. This mode is normally used only with synchronous signals; it is not generally useful for non-synchronous signals since energy will be spread across the entire spectrum unless the signal is exactly at bin center. The maximum amplitude error due to the rectangular window attenuation is about 4 dB. For synchronous signals, there is no amplitude error.

None, move to bin center

This choice also does not apply a window function, but it is not restricted to signals that are synchronous. **None, move to bin center** may be used with any signal which consists only of a single sinewave and any harmonically-related distortion products. For signals that are non-synchronous, this selection modifies the signal so that it becomes synchronous.

None, move to bin center shifts the fundamental frequency of the signal to the center of the nearest bin, which is the same as stretching or compressing the waveform so that an integer number of cycles fits exactly in the transform length. See Appendix C for a conceptual overview of FFTs, including basic information on synchronous FFTs.

When used with a single sinewave, this technique results in excellent selectivity, with the signal spreading to the adjacent FFT bin normally 120 dB down or more. Due to the correction, the signal in the DSP buffer will now be at an exact bin center and NOT at the original frequency.

Here's an example: assume that you want to test an ADC operating at a 48.00 kHz sample rate, using a test signal frequency of 997 Hz. This frequency is often chosen because it is non-synchronous with the sample rate and causes the converter under test to be exercised through a large number of its possible states.

With an FFT length of 16,384 samples, the two nearest synchronous frequencies are 996.09375 Hz (exactly 340 cycles in the buffer) and 999.0234375 Hz (exactly 341 cycles). The **None, move to bin center** mode of the FFT program will shift the frequency of the acquired 997 Hz signal in DSP memory down to 996.09375 Hz (the nearest synchronous frequency) and then perform a windowless FFT.

The result: the ADC under test was exercised at 997 Hz, as desired; and the frequency correction yielded an unwindowed FFT with high selectivity, as if the signal had been at the synchronous frequency of 996.09375 Hz.

The frequency correction technique has a maximum correction range of $\pm 4\%$. At the low end of the frequency range there will be frequencies which are more than 4% from a bin center. For example, with a

16,384-sample transform and 48 kHz rate, 37 Hz is approximately the lower limit above which a sinewave at any arbitrary frequency can be guaranteed to be brought to a synchronous frequency.

The technique will work at still lower frequencies if the signal frequency is within 4% of a synchronous bin center frequency. Bin center frequencies may be computed from the equation

$$\text{Frequency} = \frac{(N \times \text{Sample Rate})}{\text{Transform Length}}$$

where N is the integer number of cycles in the transform.

For example, with $N = 7$ (exactly seven complete cycles in the FFT buffer), a transform length of 16,384 and a 48 kHz rate, the synchronous frequency is 20.5078125 Hz. A $\pm 4\%$ range around that frequency extends from approximately 19.7 Hz to 21.3 Hz, and a sinewave within that range will be corrected to the synchronous frequency.

When using Sweep **Append** and Sweep **Repeat** with **None, move to bin center** as the **Window** selection, the frequency shift will be performed only once and not with every **Append** or **Repeat** operation.

Quasi-AC Coupling

Figure 136. ATS Spectrum Analyzer coupling selections.

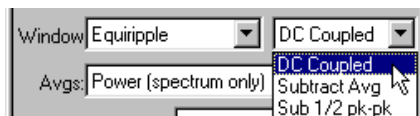

The Spectrum Analyzer can be dc coupled to the input signal, or can operate in one of two modes of quasi-ac coupling. The field at the right of the **Window** selection field offers three choices:

- **DC Coupled**

- **Subtract Avg**

When **Subtract Avg** is selected, the DSP computes the average value of all samples in the acquisition buffer and subtracts that computed value from the value of each sample, before the FFT or waveform display is performed. For noisy signals, the **Subtract Avg** selection generally results in better dc rejection than the **Subtract 1/2 pk-pk** selection.

- **Subtract 1/2 pk-pk.**

The **Subtract 1/2 pk-pk** selection computes the maximum difference between positive and negative peak values in the acquisition buffer and subtracts half that amount from each sample, before the FFT or waveform display is performed. For symmetric, low-noise signals, the

Subtract $\frac{1}{2}$ pk-pk selection generally results in better dc rejection than the **Subtract Avg** selection.

The general effect of either of these selections is similar to having used ac coupling before acquiring the signal, as long as no signal peaks exceeded digital full scale.

Use of either of the quasi-ac coupling functions may be valuable when examining low-level signals that have large dc offsets, particularly in time domain (oscilloscope) presentations where the dc offset might otherwise cause the signal to be off-screen. Either selection may introduce dc error, particularly on very low frequency signals.

Also see **Triggering with Quasi-AC Coupling** on page 182.

Averaging

Figure 137. ATS Spectrum Analyzer Averaging selections.

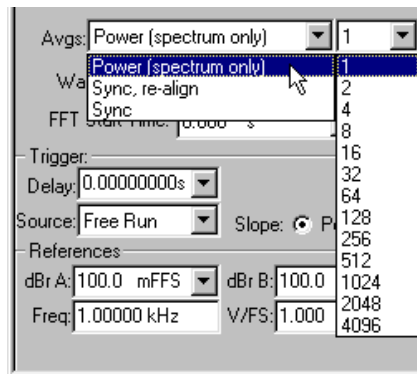

The Spectrum Analyzer provides two fundamentally different averaging techniques for better ability to measure program material and noise, or low-level and other noisy signals. These are:

- synchronous averaging, and
- power (spectrum) averaging.

Both techniques average the signal over a specified number of acquisitions. They do this by summing the signals from all acquisitions and dividing the result by the number of acquisitions.

Synchronous averaging operates on the time-domain signal, which makes it useful not only for time-domain (oscilloscope) display but also for frequency-domain (spectrum) analysis, since the source of the signal for spectrum analysis is the time-domain signal.

Power (spectrum) averaging operates only on the frequency-domain result. After each FFT is performed, the spectra for all passes are summed and then divided by the number of passes.

During an averaging process, the Status Bar at the lower left of the ATS workspace counts down through the number of acquisitions as they are performed.

Averaging factors from **2** to **4096** are available. A selection of **1** disables averaging.

Synchronous Averaging

The primary purpose of synchronous averaging is to reduce noise levels in order to provide more accurate measurements of signals which would otherwise be lost in the noise.

Synchronous averaging is performed on the acquired (time domain) signal, so it can be used when viewing noisy signals in the time domain in oscilloscope view.

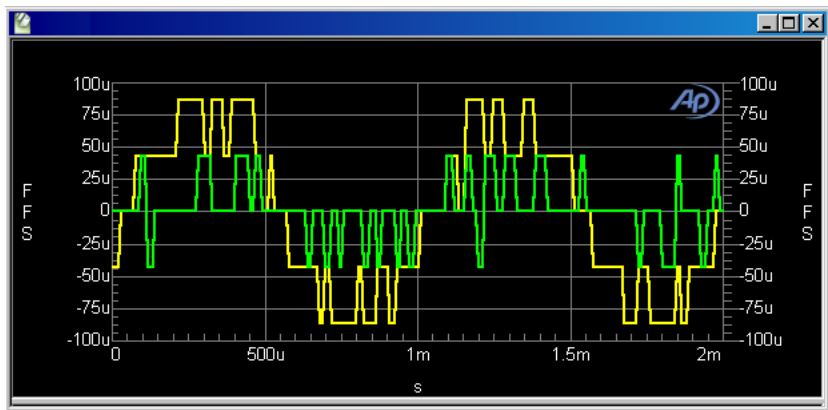

Figure 138. A time-domain view of -85 dBFS and -100 dBFS 16-bit sine wave signals, normal dither, no averaging.

Figure 138 shows a time domain display of -85 dBFS and -100 dBFS 16-bit sine wave signals with normal triangular dither and no averaging. All that can really be seen is that one signal occupies the five lowest-amplitude digital codes and the other occupies the three lowest codes.

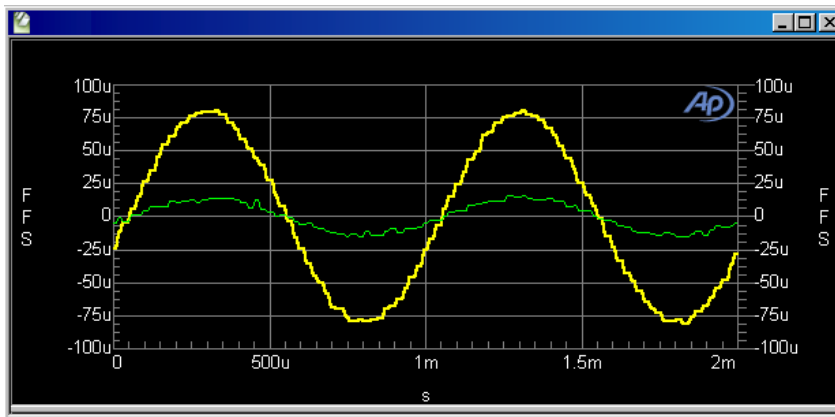

Figure 139. A time-domain view of -85 dBFS and -100 dBFS 16-bit sinewave signals, normal dither, 256x synchronous averaging, triggered from digital generator.

Figure 139 is the same signal with 256x synchronous averaging, triggered from the digital generator. The sinusoidal waveform is now clearly visible.

Signal Alignment for Synchronous Averaging

In order for the amplitude of coherent signals to be preserved during synchronous averaging, each new acquisition must be accurately time-aligned with the previous acquisitions before it is added to the accumulating signal in DSP memory. For some signals, time alignment may be accomplished by proper triggering at acquisition. Other signals may require a DSP re-alignment process. Also see **Triggering with Synchronous Averaging** on page 181.

Because of the frequency-shifting that occurs using the **None, move to bin center** Spectrum Analyzer Window selection, the synchronous averaging choices change with the FFT windowing mode. For all FFT Window selections except **None, move to bin center** the synchronous choices are:

- **Sync, re-align** and
- **Sync.**

If **None, move to bin center** is selected as the FFT **Window**, there are four synchronous choices:

- **Sync, re-align, move center first**
- **Sync, re-align, average first**
- **Sync, move center first**, and
- **Sync, average first.**

Sync (without re-align)

When you are confident that nature of the signal and the triggering selections on the Spectrum Analyzer panel are sufficient to cause each acquisition to start at the same relative point on the waveform, choose one of the synchronous selections that do *not* re-align. The “sync without re-align” options require less digital signal processing and are faster.

Sync, re-align

For some signals, re-alignment may be necessary for synchronous averaging. Choose one of the **Sync, re-align** options to select this technique.

With re-align, signal is first acquired with any triggering selection (including **Free-running**, which is untriggered). The DSP then “slides” the signal forward or backward in time until it is aligned with the sum of already-accumulated signals.

The final averaged result will start at the value set in the **Delay** field and continue from that point for the **Length** value. Any signal before and after is erased.

For example, if **8192** is selected in the **FFT** field and **100 ms** is entered in the **Delay** field (assuming that the **Acquire** field value is sufficiently long to contain 100 ms plus 8192 samples), the final averaged result will start at 100 ms and continue for a bit more than 8192 samples beyond that point (to approximately 271 ms at a 48 kHz sample rate). A time domain view or an FFT may then be made anywhere within that 8192 samples.

An FFT of a synchronously-sampled signal will be correct only if the signal transformed, as determined by FFT **Start Time** and **Length**, lies completely within the occupied portion of the buffer. In the example above, any FFT **Start Time** less than 100 ms would produce erroneous data. Any combination of **Start Time** and **Length** extending beyond the 271 ms point would also produce bad data.

Synchronous Averaging for "Move to bin center" operations

With **None, move to bin center** in the **Window** field, time aligning is more complicated because of the frequency shift imposed upon the acquired signal. The two “**average first**” selections will provide faster operation since the “**move to bin center**” operation is only done once, following all acquisitions and averaging. The “**move center first**” selections perform the bin centering operation at each acquisition, increasing the measurement time.

However, if the signal frequency changes from acquisition to acquisition because of flutter or drift, the **move center first** selections may provide

more accurate measurements. Frequency changes during synchronous averaging will result in amplitude errors since the signals will not be time-aligned at the end of the buffer even if they are synchronized at their initial zero crossing.

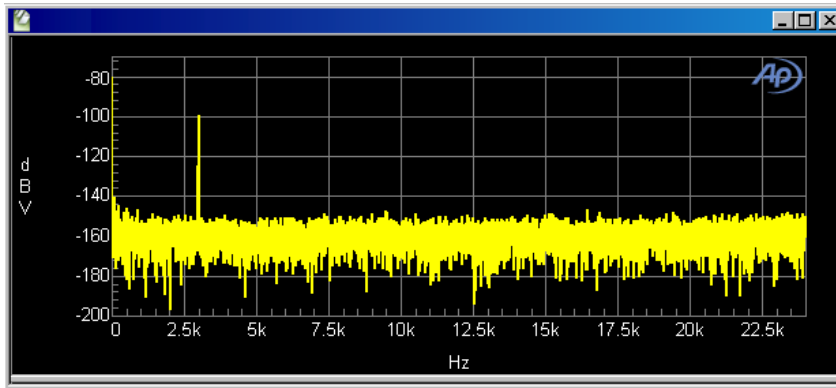

Figure 140. Low-level signal viewed in the frequency domain, no averaging.

Synchronous Averaging and Frequency Domain Views

As stated before, synchronous averaging is performed on the signal acquisition in the time domain. Since the frequency domain (spectrum) view uses this time domain acquisition, synchronous averaging is also useful for frequency domain views.

With synchronous averaging and time alignment via proper triggering or the **Sync, re-align** mode, coherent components will be unchanged by the averaging process. The average value of noise components will be reduced by 3 dB for each doubling of the averaging factor. Figures 140 and 141 show the same signal conditions, but Figure 141 has been averaged over 128 acquisitions using synchronous averaging. Note that the peak-to-peak variance of the noise is still approximately as it was with no averaging, but the average level of the noise is now approximately -180 dBV. This lowered noise floor makes clearly visible a 9 kHz distortion product, another peak at 12 kHz and the hint of another at 6 kHz.

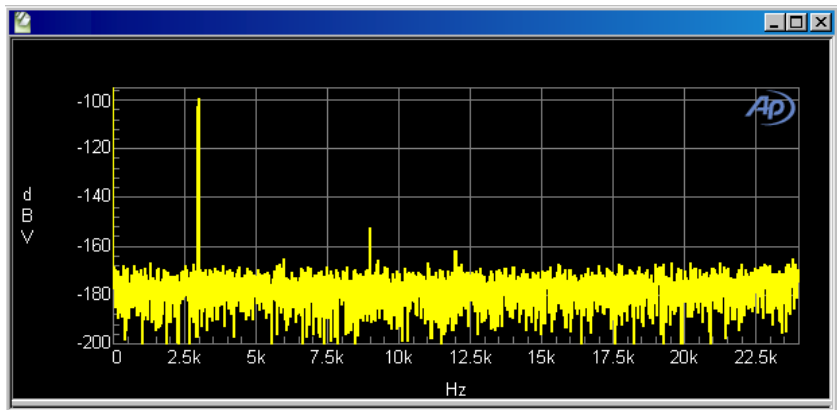

Figure 141. Low-level signal viewed in the frequency domain, averaged with 128x synchronous (time domain) averaging. Average noise level is reduced from noise level shown in Figure 140, with no change in noise variance.

Power (Spectrum) Averaging

Spectrum averaging operates only on the frequency domain (amplitude vs. frequency) results following an FFT. It will not operate if a time domain display (**FFT.Time** at **Source 1**) has been selected.

The primary purpose of spectrum averaging is to provide a more accurate measurement of the amplitude versus frequency characteristics of varying signals. ATS uses power-law (root-mean-square) averaging to correctly average noise signals.

Averaging over many seconds or minutes of noise or of program material such as music or voice is very useful in order to determine the long-term average amplitude vs. frequency distribution.

Coherent (steady or continuous) signals will be unaffected by spectrum averaging. Variable signals such as noise and program material will converge to their average values at each frequency as the averaging factor is increased. The result is that the peak-to-peak variance in the displayed noise floor or program material is reduced while coherent signal amplitudes are unchanged. The average level of the noise floor is not changed.

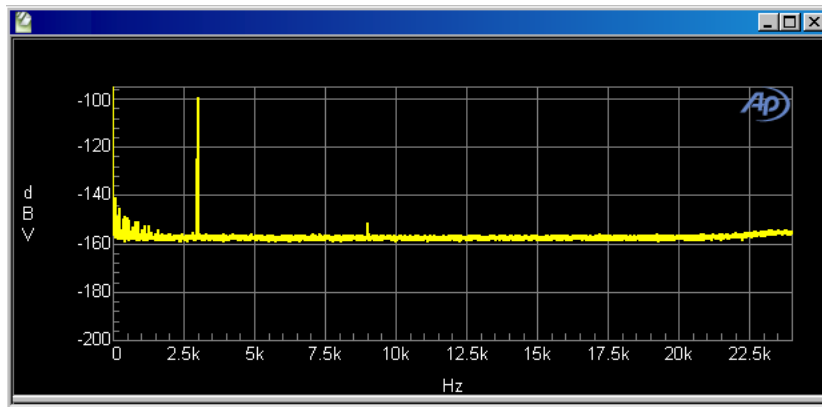

Figure 142. Low-level signal viewed in the frequency domain, 128x Power (spectrum Only) averaging. Noise variance is reduced from noise variance shown in Figure 140, with no change in average noise level.

Figure 142 shows the same signal illustrated in Figure 140 after 128x spectrum averaging. Note that the average level of the noise is about -160 dBV in either case, but the peak-to-peak variance in the noise has been reduced by the spectrum averaging. The slight rise in noise levels at high frequency due to noise-shaped dither is visible in the averaged result but not on any single acquisition and FFT.

Coherent signals very near the noise floor, such as the distortion product at 9 kHz in Figure 142, may become visible as the noise converges to its average value.

Spectrum averaging is selectable in the field to the right of the **Avgs** label as **Power (spectrum only)**.

*If a time domain view is selected following a spectrum averaging process, the **Reprocess Data** command (**Ctrl+F6**) must be used to view the time domain data, rather than the **Transform Data w/o Acquire (F6)** command. Only the last acquisition of the series of averaged acquisitions will be viewed. See page 157 for more information.*

Display Processing

Waveform (time domain) Display Processing

Four modes are available in the Spectrum Analyzer for processing the amplitude-versus-time relationship of a sampled signal before displaying the waveform. These modes are applicable only to time domain (oscilloscope) views and have no effect on frequency domain FFT spectrum analysis views.

The display processing setting determines how the data is modified for display when the spacing of the sweep points is different from the spacing of sample points in the acquisition.

The four modes available in the Wave Display field are:

- **Interpolate**
- **Display Samples**
- **Peak Values**, and
- **Absolute Values.**

Interpolate

When **Interpolate** is selected the DSP compares the density of sweep points requested with the density of sample points available in the acquisition, for the time span of the current sweep and graph.

If the requested points are much less dense than the acquisition points, the DSP uses a bipolar peak sensing mode to eliminate potential graphic aliasing problems; otherwise, it interpolates. See **Graphic Aliasing** on page 176.

In the bipolar peak sensing mode, the signal waveform is not faithfully represented but is replaced with an approximation indicating the positive and negative peak excursions of the signal.

If you use the graph **Zoom** and **Zoomout** commands, the time span represented on the graph changes. When **Interpolate** is selected, Wave Display automatically switches between bipolar peak sensing mode and interpolation mode for the best display.

The **Interpolate** selection produces a much more accurate display of the signal waveform than the **Display Samples** mode when the signal frequency is high (such as sample rate/100 or higher).

Display Samples

When **Display Samples** is selected, for each display point requested the DSP sends the amplitude of the nearest-in-time acquired sample to the computer for plotting. Acquisition sample values may be repeated or dropped, depending upon the relationship of acquisition sample density to display point density.

This mode is useful when examining the true, quantization-limited waveforms of very low amplitude digital domain signals.

When the signal frequency is low compared to the sample rate, **Display Samples** will produce an acceptable representation of the original signal

waveform. At high signal frequencies, the waveform may be entirely unrecognizable because of graphic aliasing (see page 176); in such a case, the **Interpolation** mode should normally be used.

Peak Values

When **Peak Values** is selected, the DSP searches all sample amplitudes in the acquisition buffer between each pair of X-axis time values plotted, and sends to the computer for plotting the largest positive value in that span.

Since all sample values are examined, no signal peaks can be missed.

Absolute Values

When **Absolute Values** mode is selected, the DSP searches all sample amplitudes in each plotted-point-to-plotted-point span as it does in **Peak Values** mode, but takes the absolute value of the largest positive or negative value, always sending a positive number to the computer.

Logarithms may be computed when all the numbers involved are positive, so **Absolute Values** mode brings the advantage that decibel units may be used on the Y-axis to display the waveform.

Waveform display with **Absolute Values** mode can create a wide-dynamic-range oscilloscope view that displays the envelope of an audio signal, calibrated in units such as dBV, dBu, and so on.

***Absolute Values** mode is most effective at representing the signal envelope when the X-axis span and the Sweep panel **Points** values are selected to produce approximately two plotted points per cycle of the waveform being graphed. For example, if an envelope display of tone burst waveforms of a 1 kHz signal (1 ms period) is being plotted across a 50 ms span, the **Points** value on the Sweep panel should be set to approximately 100.*

Graphic Aliasing

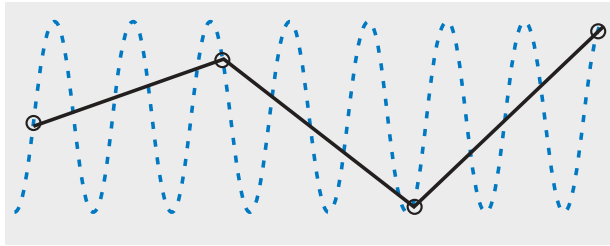

Figure 143. An example of graphic aliasing, where a large number of samples is represented by a small number of graph points, resulting in the display of an alias waveform.

When the density of samples is high compared to the density of graph points requested by the sweep **Steps** setting, many samples will be skipped and not plotted. Depending upon the signal and settings, waveforms very different from the signal waveform may be displayed. This is called graphic aliasing.

ATS has provided several display processing modes (discussed in detail previously) that minimize graphic aliasing problems. You can help avoid graphic aliasing in the following ways, as appropriate to your test:

- Use a larger number of sweep **Steps**.
- Use a shorter sweep span.
- Use the **Interpolate** display processing mode. **Interpolate** automatically switches from interpolation to bipolar peak sensing to avoid graphic aliasing.
- Use the **Peak Values** or **Absolute Values** modes, if appropriate.

The **Display Samples** display mode is most likely to exhibit graphic aliasing. If you use **Display Samples**, be sure that the number of graph points is sufficient to correctly display the number of sample points in the time span.

Spectrum (frequency domain) Display Processing

If the distance between the **Steps** in a sweep is greater than the width of one bin, plotted points are selected by a mechanism called *peak picking*. With peak picking, the DSP searches all bins between the previous plotted point and the current point, and plots the highest bin amplitude within that range. This ensures that no peaks are missed. Peak picking is used for all ATS FFT-generated frequency domain displays.

FFT Start Time

You can select any point in the acquired signal record as the beginning of the portion to be transformed. This is the **FFT Start Time**.

The FFT is then computed for the contiguous section of samples starting at the sample at the start time, and continuing for the number of samples chosen in the **Length** field. This permits selective spectrum analyses of different sections of complex signals such as program material, or special test signals such as sinewave bursts.

To change the value of **FFT Start Time**, click in the field and type in a new number from the keyboard. The maximum value for **FFT Start Time** depends on the sample rate, the acquisition length (in samples) and the FFT length (in samples), as follows:

$$\text{Maximum Start Time} = \frac{\text{Acquisition Length} - \text{FFT Length}}{\text{Sample Rate}}$$

If the original signal acquisition was made with a negative value in the trigger **Delay** field, negative values up to and including that same value may be used as **FFT Start Time** values, permitting spectrum analysis of the pre-trigger section of the acquired record.

Triggering

Figure 144. Spectrum Analyzer **Trigger Source** selections.

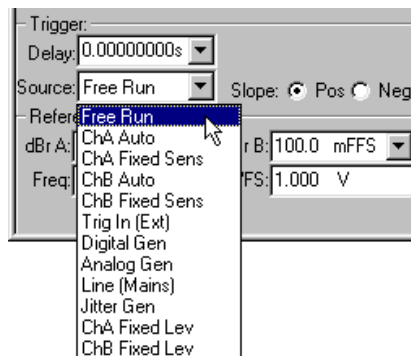

The **Trigger** section of the Spectrum Analyzer consists of the **Source** field, a **Sens** (sensitivity) or **Lev** (level) field for certain trigger **Source** selections, and the **Slope** option buttons to select positive or negative slopes. Acquisition of signal into the FFT acquisition buffer may start immediately at Sweep **Start**, or may wait for a trigger event, depending upon the setting of the **Source** field.

The selections are:

- **Free Run**
- **ChA Auto**
- **ChA Fixed Sens**
- **ChB Auto**
- **ChB Fixed Sens**
- **Trig In (Ext)**
- **Digital Gen**
- **Analog Gen**
- **Line (Mains)**
- **Jitter Gen**
- **ChA Fixed Lev**
- **ChB Fixed Lev**

Free Run

When **Free Run** is selected, signal acquisition begins immediately after Sweep **Start (F9 or Go)** is initiated, regardless of signal amplitude.

Auto

The **ChA Auto** and **ChB Auto** selections will cause triggering at one-half the peak-to-peak value if the selected channel has a signal amplitude greater than digital infinity zero.

Fixed Sensitivity

ChA Fixed Sens and **ChB Fixed Sens** use the value set in the **Sens** (sensitivity) field as the triggering threshold. The **Sens** field appears only when one of these two selections is made.

An FFT acquisition will trigger on the first zero crossing of the selected slope (positive or negative, set with the adjacent option buttons) that occurs after the signal amplitude is sufficient to swing both through zero and the **Sens** value.

If the signal contains a sufficient DC offset such that it does not swing through zero, no triggering will take place. In this case, use one of the quasi-AC coupling modes (**Subtract Avg** or **Sub ½ pk-pk**) that will

cause the processed signal to pass through zero and permit triggering to function.

Trig In (Ext)

The **Trig In (Ext)** selection refers to the **TRIG IN** BNC connector on the rear of the ATS-2 chassis. The trigger circuitry is edge-sensitive, and an FFT acquisition will trigger on a positive-going or negative-going edge on the signal at this connector, depending upon the setting of the trigger **Slope** buttons.

Digital Gen

If the Digital Generator is outputting a Noise waveform, a **Digital Gen** trigger occurs once per cycle of the noise sequence.

If the Digital Generator is outputting an Arbitrary Waveform, a **Digital Gen** trigger occurs at the first sample of the waveform.

For all other waveforms, a **Digital Gen** trigger occurs at each cycle of the waveform.

Analog Gen

If the Analog Generator is outputting a Noise waveform, an **Analog Gen** trigger occurs once per cycle of the noise sequence.

If the Analog Generator is outputting an Arbitrary Waveform, an **Analog Gen** trigger occurs at the first sample of the waveform.

For all other waveforms, an **Analog Gen** trigger occurs at each cycle of the waveform.

Line (Mains)

The **Line (Mains)** provides a trigger at each cycle of the AC waveform of the mains line powering ATS-2.

Jitter Gen

The **Jitter Gen** selection provides a trigger at each cycle of the waveform selected in the **Jitter Generation** section on the DIO panel. This provides stable viewing of the jitter waveform generated by ATS-2.

Fixed Level

The **ChA Fixed Lev** and **ChB Fixed Lev** fields operate identically to conventional oscilloscope triggering.

When either of these trigger selections is chosen, a level (**Lev**) setting field is displayed. Positive or negative values may be entered into this field. An acquisition will be triggered the first time the signal with the specified slope (positive or negative) passes through this level.

Trigger Delay Time

Figure 145. ATS Trigger Delay and Slope selections.



*If a negative value was entered in the trigger **Delay** field before **Sweep Start** was pressed, the portion of the record selected for transform by the **FFT Start Time** field can extend back into the pre-trigger portion of the record by entering a negative value in the **FFT Start Time** field.*

The **Spectrum Analyzer** instrument has the ability to fill the acquisition buffer with signal samples beginning at the moment of the triggering event, or starting at a defined time before or after the trigger occurs. This time is set in the trigger **Delay** field.

This enables analysis of signal conditions both before and after the triggering event.

A negative value entered in the **Delay** field determines the length of time prior to the trigger event signal that samples are retained. The total length of signal acquired will be as defined in the **Length** field, with the remainder of the acquisition buffer filled after the trigger.

For example, with the **Acquire** set to **24k** the length of the acquisition buffer for each channel is 512 ms at a 48 kHz sample rate. If the trigger **Delay** time value is -50 ms, then 462 additional milliseconds of signal following the trigger will also be acquired to fill the entire 512 ms buffer.

Trigger Slope

See Figure 145.

To the right of the trigger **Source** field are the trigger **Slope** buttons. Selecting **Pos** causes triggering to occur on a positive-going portion of the trigger source signal, while **Neg** causes triggering on a negative-going waveform.

Triggering with Synchronous Averaging

Synchronous averaging, which depends on the precise alignment of many acquisitions, requires careful consideration of triggering techniques. See **Synchronous Averaging** on page 167.

Without Re-alignment

If synchronous averaging without re-align mode is used, proper triggering is absolutely essential. Random, untriggered acquisitions will not be aligned in time, resulting in cancellation of coherent signals and large amplitude errors.

In stimulus-response testing from ATS-2, either the **Analog Gen** or **Digital Gen** (as appropriate) FFT trigger sources should be used. If an external signal is presented from another signal source, one of the **ChA** or **ChB** selections should be used as trigger source.

If signals are being acquired on both channels without re-align, they must be at the same frequency or must have harmonically-related frequencies. Sync without re-align will properly measure only signals harmonically related to the trigger source. A signal whose frequency is not related to the trigger source may have large amplitude errors or may entirely disappear.

With Re-alignment

The re-align mode should be used for accurate amplitude measurements on all signals above about 10% of the sample rate. Without realignment, the random time relationship between the signal itself and ATS-2's sample clock will cause random misalignment up to $\frac{1}{2}$ clock period, resulting in partial cancellation that becomes objectionable at high frequencies. Re-alignment works with interpolated versions of the signal and aligns accurately, producing accurate amplitude measurements even at high frequencies.

The re-align mode works independently on each channel. If the two channels carry different frequency signals, re-align mode must be used.

The primary disadvantage of the re-align mode is the additional time taken by the DSP to do the operation after each acquisition.

The synchronous averaging with re-align

- acquires signal according to whatever triggering selections are in use,
- interpolates the acquired signal between the actual sample values,
- locates the first positive-going zero crossing in the interpolated data,
- time-aligns that with the first zero crossing in the accumulated record, and

- adds the signal from that point onwards into the averaging buffer.

This process is carried out after each of the series of acquisitions to be averaged, resulting in precise time alignment.

Triggering is not critically important in this mode if the signal is not noisy and the signal repetition rate is relatively high, since the necessary alignment takes place in the DSP buffer after acquisition.

Noisy signals may not be correctly aligned by this mode, resulting in amplitude error.

Triggering with Quasi-AC Coupling

The Spectrum Analyzer's quasi-ac coupling (see page 166) occurs before acquisition triggering, so the selection must be considered when attempting to trigger on a low-level portion of a signal.

In the synchronous averaging mode, the DSP must find a zero crossing in order to time-align waveforms for averaging. If the waveform contains sufficient dc, there will be no zero crossings. If this dc is removed before averaging there will be zero crossings, permitting alignment.

The **Subtract Avg** mode may introduce error on low frequency signals that could be a problem for the DSP in finding zero-crossing locations. For well-behaved signals the **Subtract 1/2 pk-pk** function should produce acceptable results.

References

Analog and digital amplitude and frequency references for the Spectrum Analyzer are the same as for other Analyzer instruments. See **Analyzer Analog References** on page 151 and **Analyzer Digital References** on page 152.

The Sweep Spectrum/Waveform Button



ATS provides a dedicated FFT button for simplified Sweep panel setup and easy switching between frequency domain and time domain viewing. This button is called the **Sweep Spectrum/Waveform** button and is located on the Standard Toolbar. It is available when the Spectrum Analyzer, the Multitone Audio Analyzer or the Digital Interface Analyzer is the Analyzer instrument, and is grayed out under other conditions.

In a new test, first select the Spectrum Analyzer as the Analyzer instrument, then click the **Sweep Spectrum/Waveform** button. This will automatically enter Sweep panel settings for a two-channel FFT spectrum

display. Click Sweep **Start** and you will see the FFT plot on the Graph panel.

Click the **Sweep Spectrum/Waveform** button again, and the Sweep panel settings will be re-set for a two-channel waveform display. Click again and the display will toggle back to a spectrum display.

Clicking the **Sweep Spectrum/Waveform** button does not acquire or re-acquire data; it only re-transforms the acquired waveform for time domain or frequency domain display. Click Sweep **Start** to acquire new data.

Figure 146. ATS Sweep panel showing “Waveform” toggle button.

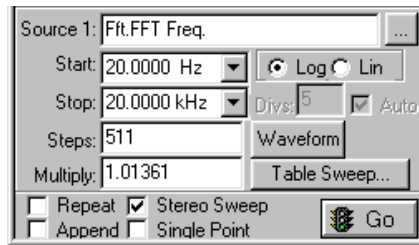

Once an FFT spectrum or waveform view has been set up on the Sweep panel, a new button appears on the panel. In waveform view, this button is labeled **Spectrum**; in spectrum view, it is labeled **Waveform**. This button controls the same toggling functions as the **Sweep Spectrum/Waveform** button.

Acquired Waveform Files

As with other ATS tests, you can save the setup and results of any Spectrum Analyzer tests as an .ats2 test file. The acquired waveform in the FFT acquisition buffer, however, is not saved as part of a test. If you want to keep the acquired data record for further analysis, you must save it as an .aam (acquisition, mono) or .aas (acquisition, stereo) acquired waveform file.

Single-channel “mono” waveforms saved at different times can later be individually loaded into the two channels of the FFT acquisition buffer to become “stereo” acquisitions for comparison in the time or frequency domains.

Saving Acquired Waveforms

Figure 147. ATS Spectrum Analyzer **Save Stereo Waveform** dialog box.

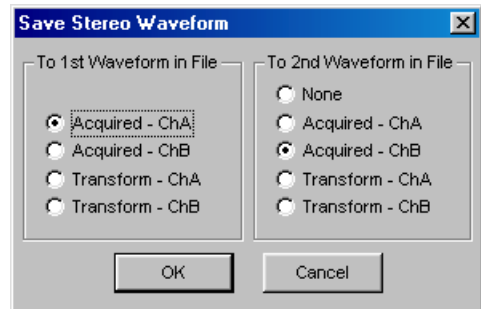

To save an acquisition, select the **File > Save As** menu command, choosing either the **Stereo Waveforms** (.aas) or **Mono Waveforms** (.aam) as the file type.

A stereo acquisition waveform file consists of two waveforms joined together into a single file; a mono acquisition waveform file contains a single waveform. To simultaneously save the waveforms from both acquisition buffer channels A and B, select the stereo choice. To save only one of the channels, select mono.

The left half of the dialog box defines what will be saved into the first section of a waveform file and the right half defines what will go into the second section of a stereo waveform. If the **File > Save As > Mono Waveform** option was selected, the right half of the dialog will be gray.

You can save the entire acquisition record or just the portion currently designated for transformation from either the channel A or channel B acquisition data. If the transform length is shorter than the acquisition record length, the waveform file will be correspondingly smaller.

Opening Acquired Waveforms

Figure 148. ATS Spectrum Analyzer **Open Stereo Waveform** dialog box.

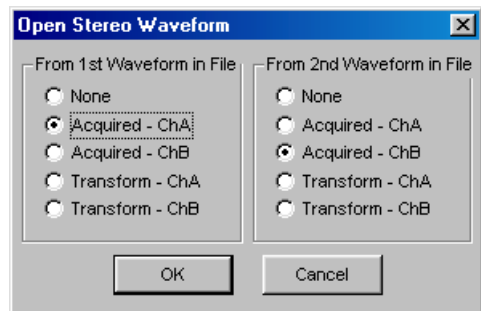

To open an acquired waveform file, select the **File > Open** menu command, choosing either the **Stereo Waveforms** (.aas) or **Mono Waveforms** (.aam) as the file type.

You can load one waveform or simultaneously load both waveforms into memory from a stereo file, and you can choose to assign the waveform to either FFT channel and to the acquisition or the transform buffers. A mono file only contains one waveform, but you have the same flexibility to load it into either channel or either buffer. When opening a mono waveform file, the right half of the dialog box will be gray.

If acquisition in a file to be opened is greater than the length of the specified buffer, an error warning will be displayed and the file will not be opened. If the acquisition length in the file is shorter than the buffer size, erroneous analysis will result if the selected FFT length extends beyond the last data sample in the buffer. You can view the data in the time domain to determine exactly where the signal ends.

Combining Mono to Stereo

To compare two single-channel acquisitions made at different times or under different conditions, open the file containing the first acquisition data. Assign the waveform to FFT channel A or B and load the data. Then open the second waveform file and do the same, this time loading the data into the opposite FFT channel.

The resulting two-channel acquisition can be transformed, processed and viewed, and can be saved as a new stereo waveform file.

Compatibility of Acquired Waveform Files

The waveform files used by both the Spectrum Analyzer and the Multitone Audio Analyzer have the same format, and with certain restrictions on length, can be used by either instrument.

The Spectrum Analyzer has a larger acquisition buffer, and can open waveform files up to 256k samples in length. Multitone is limited to opening files with acquisitions of 32k or fewer samples.

Also, although any multitone waveform can be analyzed by the Spectrum Analyzer, only properly-formatted waveform files are useful in Multitone. See Chapter 13 for more information about the Multitone Audio Analyzer.

Chapter 12

The Digital Interface Analyzer

Overview

The **Digital Interface Analyzer** is an optional DSP instrument selection on the Analyzer panel. It is named “**Intervu**” on instrument browser lists and in AP Basic macro references.

The Digital Interface Analyzer brings to ATS-2 the capability for in-depth analysis of the serial digital interface signal.

The Digital Interface Analyzer is included with the ATS-2 Performance Upgrade Option package. Check the serial number / option label on the rear of the ATS-2 chassis to verify the presence of the Performance Upgrade Option. If this option is not installed, the Digital Interface Analyzer will not be available on the Analyzer panel.

ATS-2 Digital Interface Analyzer Analysis Tools

The AES3/IEC60958 serial digital interface signal which carries the embedded audio can be analyzed as a signal in its own right.

The ATS-2 digital input is connected to a receiver circuit that recovers the timing information, the audio data and the non-audio data from the serial digital interface signal. Basic information about the interface signal is reported to the DIO panel, which displays real-time voltage and jitter amplitude measurements, and flags up to four defined errors with panel indicators. Also, the jitter signal appears as an input selection to the **Spectrum Analyzer** for further analysis. For more information, see Chapter 7 regarding interface measurements on the DIO panel, and Chapter 11 for jitter analysis with the **Spectrum Analyzer**.

The optional Digital Interface Analyzer provides additional capability, adding powerful interface signal acquisition and analysis tools that are discussed in this chapter.

See Appendix B for a discussion of digital audio and the serial digital interface signal.

Digital Interface Analyzer Components

The Digital Interface Analyzer includes two key components: a dedicated analog-to-digital converter (ADC) connected to the digital input, and specialized FFT analysis and display tools.

The Digital Interface Analyzer ADC

The dedicated Digital Interface Analyzer ADC digitizes the interface waveform as it enters ATS-2, providing a source of acquisitions for the Digital Interface Analyzer FFT analysis. The ADC is an 8-bit converter with an 80.00 MHz sample rate, providing an analysis capability with approximately 30 MHz bandwidth. The Digital Interface Analyzer acquires 1,572,864 samples into its FFT acquisition buffer, resulting in 19.66 ms of data.

Digital Interface Analyzer Capabilities

The Digital Interface Analyzer provides analysis results in three different types of displays:

- time-domain waveform displays, including interface signal waveforms, interface signal eye patterns and jitter signal waveforms,
- frequency-domain displays, including interface signal spectrum and jitter signal spectrum, and
- statistical displays, including histograms of interface amplitude, interface rate, interface bit width and jitter amplitude.

The Digital Interface Analyzer uses FFT analysis techniques that have much in common with the techniques discussed in Chapter 11. Also see Appendix C for a conceptual overview of FFTs.

Loading the Digital Interface Analyzer

Figure 149. Loading the Digital Interface Analyzer.

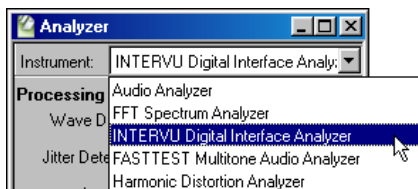

To use the **Digital Interface Analyzer**, first open the Analyzer panel. The Analyzer panel is a command selection on the Panel menu, and is also available by the keyboard shortcut **Ctrl+Y**, or by clicking the **Analyzer** button on the Toolbar.



Now select **INTERVU Digital Interface Analyzer** from the list on the Analyzer panel. This loads the Digital Interface Analyzer program into DSP.

The Digital Interface Analyzer panel

Figure 150.
The Digital Interface Analyzer panel.

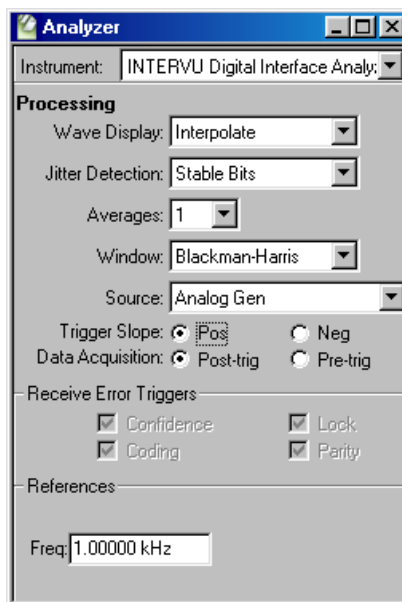

Unlike the other Analyzer instruments, the Digital Interface Analyzer panel has no real-time meter displays. Although a number of settings and preferences are made on the panel, all the results are displayed on the Graph panel in conjunction with settings on the Sweep panel.

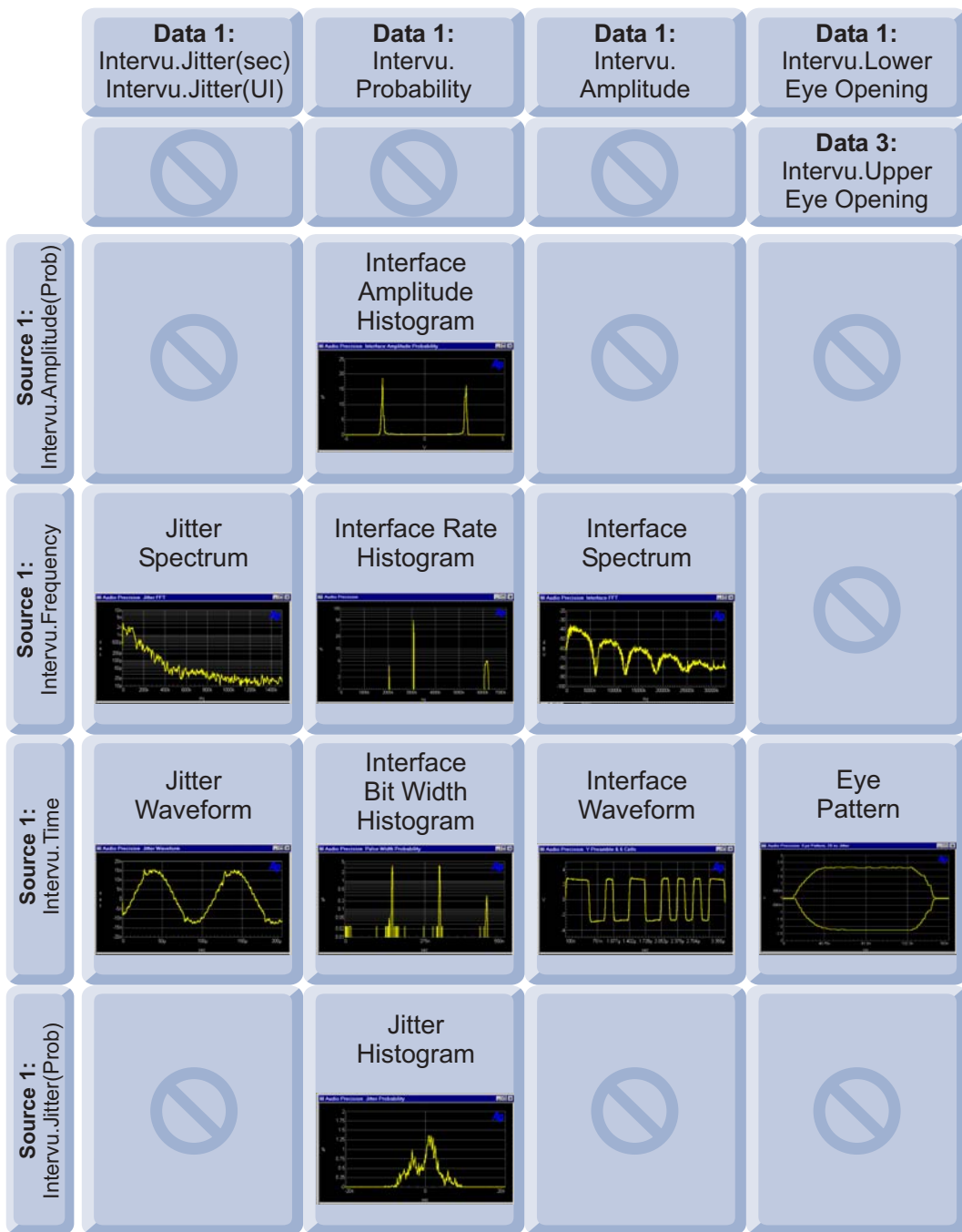

Figure 151. Sweep panel selections for the Digital Interface Analyzer views.

Later in this chapter we will look at the Digital Interface Analyzer panel in detail, but first we will look at the Sweep panel settings necessary to create the nine basic Digital Interface Analyzer views.

The chart in Figure 151 shows the nine views and the Sweep **Source 1** and **Data 1** (and **Data 3**, for Eye Pattern) settings which define the views. Also see **InterVuMenu.atsb** on page 201. InterVuMenu.atsb is a macro that makes the Digital Interface Analyzer setup a one-click process, combining a graphical menu interface with automated setup for the nine Digital Interface Analyzer views.

Digital Interface Analyzer Waveform Views

The Digital Interface Analyzer offers two waveform views of the digital interface signal and one of the interface jitter signal.

Interface Waveform

The interface waveform view shows the bi-phase mark encoded bitstream which is the serial digital interface signal. The 3 UI-wide preamble cell is clearly visible in this view, shown in Figure 152. See page 380 for an explanation of the *unit interval*, or UI.

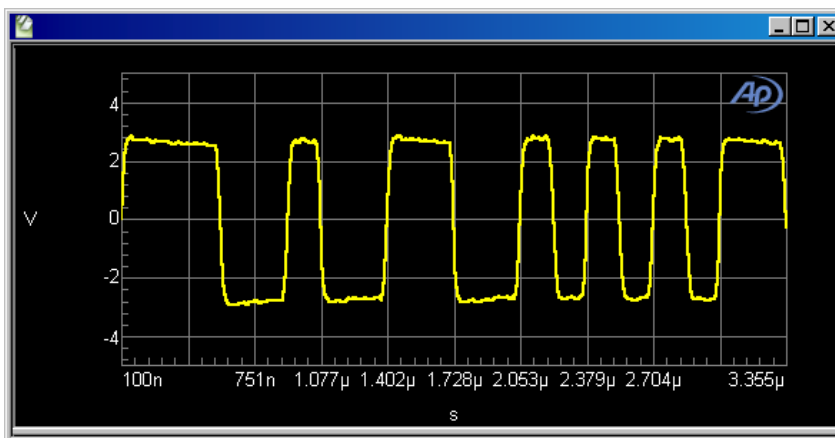

Figure 152. Digital Interface Analyzer interface waveform display. The “Y” preamble followed by six data cells is shown.

As indicated in Figure 151, this view requires these Sweep settings:

- **Source 1** = **Intervu.Time**, and
- **Data 1** = **Intervu.Amplitude**.

Source 1 range should be about ± 5 V.

Data 1 range will vary according to your requirements, signal conditions, sample rate, triggering choices and so on. A range of **0 s to 4 μ s** with a 48 kHz sample rate will show a preamble and a few data cells, as in Figure 152; shorter spans will show pulse aberrations and rise and fall times; a range of 0 s to 25 or 35 μ s displays an entire frame.

On the Digital Interface Analyzer panel, **Wave Display** can be set to any choice except **Eye Pattern**.

Eye Pattern

The eye pattern is a special view of the interface waveform which gives a quick estimation of the quality of the signal.

With conventional oscilloscopes, the eye pattern is created by setting the horizontal sweep to about one UI, triggered at the cell rate (2 UI). The persistence of the screen phosphors (or the storage capabilities of the scope) display an overlay of hundreds or thousands of data cells.

This produces a one-cell-wide display with a shape like an eye. The inside of the eye is reduced horizontally by jitter (which moves the left and right sides of the eye in and out); the eye is reduced vertically by noise (which moves the top and bottom of the eye up and down) or by reduced signal level; bandwidth reductions tip the leading or trailing sections of the eye opening.

The Digital Interface Analyzer collects a long series of data cells (about 120,000 at a 48 kHz sample rate) and produces a graphic display equivalent to the inside of an eye pattern on an oscilloscope.

AES3 specifies a minimum eye opening of 200 mV vertically by 0.5 UI horizontally. The AES3 minimum can be superimposed as a reference on the eye pattern display by entering these values into a Limit file. The file 48kAES3 Eye-Pattern.atsl is provided as a sample of such a Limit file.

On the Digital Interface Analyzer panel, **Wave Display** must be set to **Eye Pattern**.



Figure 153. Digital Interface Analyzer eye pattern (48 kHz rate).

As indicated in Figure 151, this view requires these Sweep settings:

- **Source 1 = Intervu.Time,**
- **Data 1 = Intervu.Lower Eye Opening,** and
- **Data 3 = Intervu.Upper Eye Opening.**

If you set Wave Display to **Eye Pattern** and then check **Stereo Sweep** on the Sweep panel, these selections will be made.

Source 1 range should be **0 ns** to about **165 ns**, and **Data 1** and **Data 3** ranges should be about **±3 V**. These will vary according to your requirements, signal conditions, sample rate, triggering choices and so on.

Jitter Waveform

The jitter modulating the interface waveform can be recovered and viewed as a signal in its own right. This selection shows the jitter waveform in the time domain.

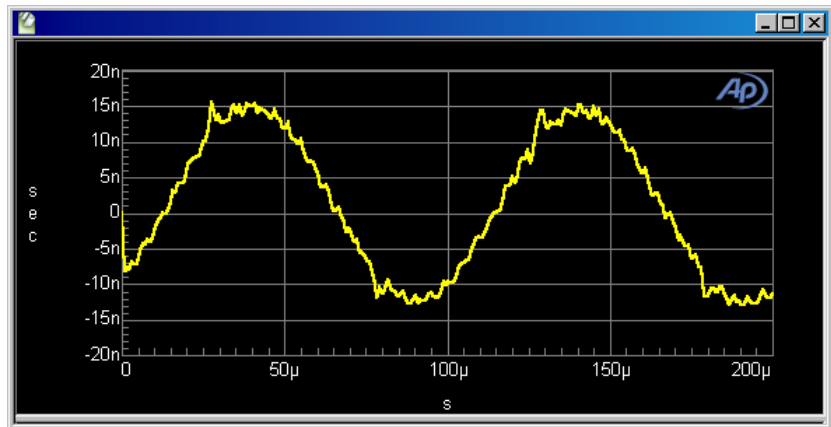

Figure 154. Digital Interface Analyzer jitter waveform, showing 10 kHz sinewave jitter from DIO jitter generator.

As indicated in Figure 151, this view requires these Sweep settings:

- **Source 1** = **Intervu.Time**, and
- **Data 1** = **Intervu.Jitter(sec)** or **Intervu.Jitter(UI)**

Jitter is a time modulation, and jitter amplitude is expressed in units of time, either in seconds or in UI. You choose between the two expressions when you make your jitter selection in the **Data** instrument browser.

The **Source 1** range will vary with the frequency of the jitter signal. Jitter frequencies can range from almost 0 Hz to several tens of kilohertz. Figure 154 shows a jitter sinewave with a period of about $100\ \mu\text{s}$, giving a fundamental frequency of about 10 kHz; **Source 1 Stop** is set at $200\ \mu\text{s}$. The **Data 1** range will vary with the jitter amplitude. Typical jitter amplitude ranges from 5 ns to 20 ns or more; Figure 154 shows a range of $\pm 20\ \text{ns}$.

On the Digital Interface Analyzer panel, **Wave Display** can be set to any choice except **Eye Pattern**.

See **Jitter Detection** on page 204 for more information.

Digital Interface Analyzer Spectrum Views

The Digital Interface Analyzer provides spectrum (frequency domain) views of the both the digital interface signal and the jitter signal extracted from the interface signal.

Interface Spectrum

The interface spectrum view shows a spectrum analysis of the serial digital interface signal, covering a frequency range extending from 0 Hz to over 30 MHz.

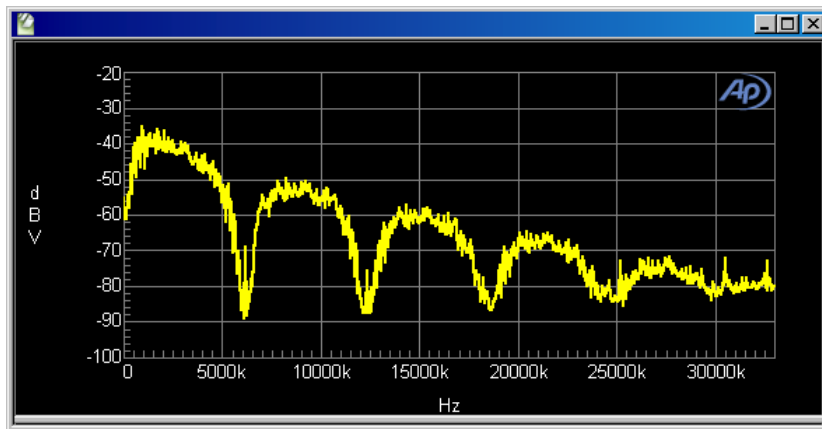

Figure 155. Digital Interface Analyzer interface signal spectrum analysis, 48 kHz rate.

As indicated in Figure 151, this view requires these Sweep settings:

- **Source 1 = Intervu.Frequency**, and
- **Data 1 = Intervu.Amplitude**.

Source 1 range should be **0 Hz** to about **35 MHz**; **Data 1** range about **0 dBV** to **-100 dBV**. These will vary according to your requirements, signal conditions, triggering choices and so on.

On the Digital Interface Analyzer panel, **Wave Display** can be set to any choice except **Eye Pattern**.

Jitter Spectrum

The jitter spectrum view shows a spectrum analysis of the jitter signal modulating the interface signal, covering a frequency range extending from 0 Hz to over 1.5 MHz, depending on the jitter detection employed.

When excessive jitter has been determined to be a problem, spectrum analysis of the jitter signal is a powerful tool in locating the probable source.

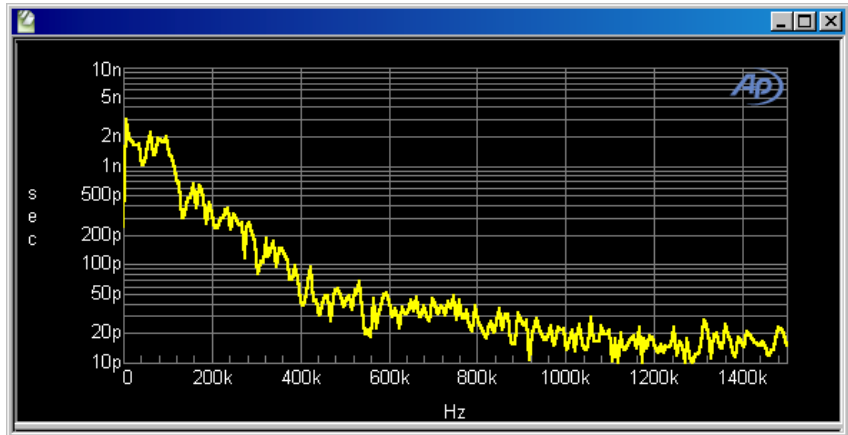

Figure 156. Digital Interface Analyzer spectrum analysis of jitter signal.

As indicated in Figure 151, this view requires these Sweep settings:

- **Source 1** = **Intervu.Frequency**, and
- **Data 1** = **Intervu.Jitter(sec)** or **Intervu.Jitter(UI)**.

Source 1 range should be **0 Hz** to about **1.5 MHz**; **Data 1** range about **1 ps** to **20 ns** on a log scale. These settings will vary according to your requirements, signal conditions, sample rate, triggering choices and so on.

When jitter signals below 120 kHz are being studied, use of the **Spectrum Analyzer** instrument with the **Jitter Signal** source will provide superior frequency resolution compared to the Digital Interface Analyzer. Jitter signal analysis using the Spectrum Analyzer is discussed in Chapter 11.

Calibration for Digital Interface Analyzer jitter measurements is in terms of rms values, contrasting with the peak or average values selectable for the DIO panel jitter meter. The DIO panel jitter generator is calibrated in peak values.

Digital Interface Analyzer Histograms

A histogram is a statistical view, showing the probability of occurrence of a set of events throughout a range of possibilities.

Here's an example: the interface waveform nominally moves across a 5 Vpp range with very quick transitions. The probability of the instantaneous voltage being either +2.5 V or -2.5 V is high, and all other voltages have a low probability. The interface amplitude histogram shown in Figure 157 displays these probabilities.

Interface Amplitude Histogram

The interface amplitude histogram view shows a graph of the probability of the interface signal being at particular points across a range of amplitudes. When characterizing the squareness of a digital signal it is often convenient to view a histogram of the signal amplitude.

With no impairment of the interface signal, the resulting histogram will consist essentially of two vertical spikes. One is located at approximately the signal negative peak value and the other at the positive peak value.

If the interface signal pulse top and bottom are clean and level (no tilt or aberrations), the spikes will be narrow and of high probability values. Slower rise and fall times cause each spike to broaden in the direction of zero volts. Normal-mode noise causes broadening of each spike to both lower and higher amplitude values. If these impairments are severe enough, the two spikes will merge into a low probability lump spread across the peak-to-peak voltage range of the signal.

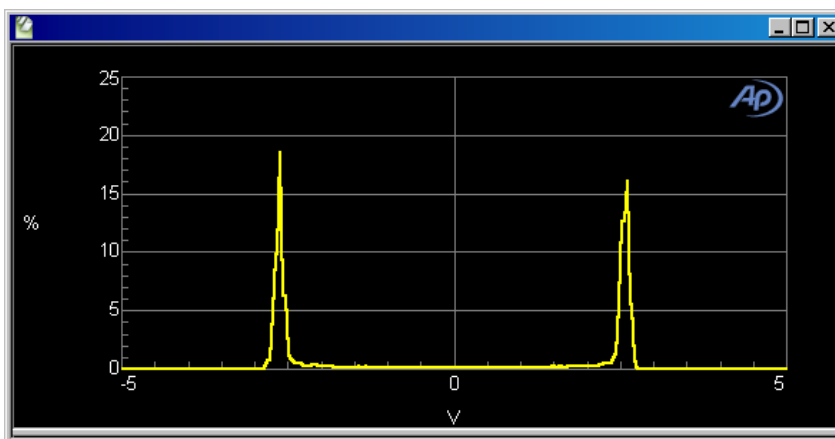

Figure 157. Digital Interface Analyzer interface signal amplitude probability, 5 Vpp signal.

As indicated in Figure 151, this view requires these Sweep settings:

- **Source 1** = **Intervu.Amplitude(Prob)**, and
- **Data 1** = **Intervu.Probability**.

Source 1 range should be about ± 5 V; a **Data 1** range of 0% to about 20% on a linear scale is useful for this view.

Interface Pulse Width Histogram

The interface pulse width histogram view displays the probability of various values of width for interface signal pulses.

With no impairment of the interface signal, the resulting histogram will consist essentially of three vertical spikes at the 1 UI, 2 UI, and 3 UI points on the horizontal axis. The height of each UI spike shows the probability of pulse widths of that value occurring. For typical audio data, the 1 UI and 2 UI spikes will be approximately equal, indicating approximately equal numbers of one and two UI-wide pulses (logical ones and zeros in the embedded audio data). The 3 UI spike is significantly shorter (lower probability) since pulses of that width occur only in the preamble. Impaired rise and fall time and/or interfering noise will cause each spike to become wider, at correspondingly lower probability for any specific pulse width value.

The displayed time resolution of the pulse width histogram depends upon the span between the **Source 1 Start** and **Stop** values and the **Source 1 Steps** value.

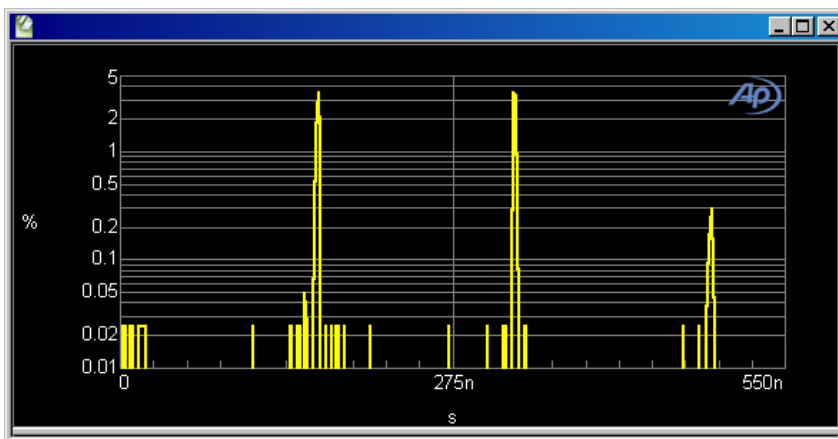

Figure 158. Digital Interface Analyzer interface pulse width (interface timing) probability, 48 kHz rate.

As indicated in Figure 151, this view requires these Sweep settings:

- **Source 1** = **Intervu.Time**, and
- **Data 1** = **Intervu.Probability**.

Source 1 range should be about **0** to **600 ns**; a **Data 1** range of **0.01%** to about **10%** on a logarithmic scale is useful for this view.

On the Digital Interface Analyzer panel, **Wave Display** can be set to any choice except **Eye Pattern**.

Interface Bit-Rate Histogram

The interface bit-rate histogram view displays the probability of occurrence of the various instantaneous frequency values of the interface waveform.

The Digital Interface Analyzer can “invert” the pulse width histogram described above to obtain a bit-rate histogram. The time between each successive pair of zero crossings of the interface signal is measured and these times are sorted into bins depending upon their value.

Figure 159 shows three spikes, corresponding to the frequency equivalents of the 3 UI, 2 UI, and 1 UI pulses that make up the signal. At a 48 kHz sample rate, the 3 UI pulses are equivalent to a frequency of about 2.07 MHz, the 2 UI pulses correspond to a frequency of about 3.10 MHz, and the 1 UI pulses are equivalent to a frequency of about 6.16 MHz. Jitter will spread each spike across the nearby spectrum.

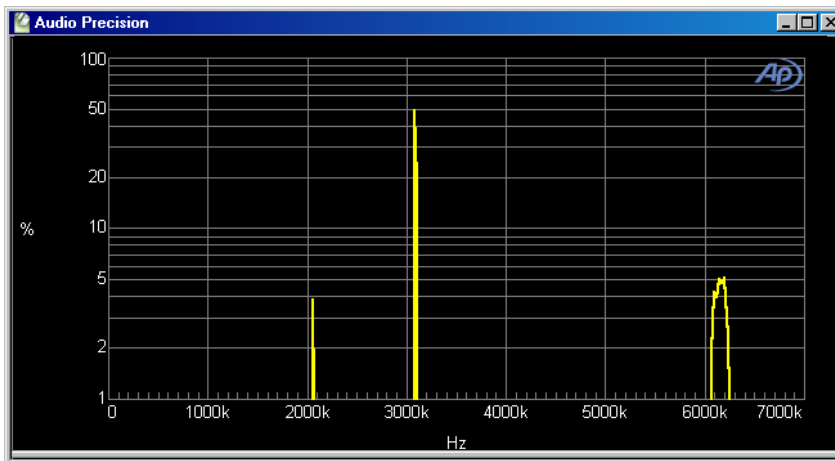

Figure 159. Digital Interface Analyzer interface rate probability, 48 kHz rate.

As indicated in Figure 151, this view requires these Sweep settings:

- **Source 1** = **Intervu.Amplitude**, and
- **Data 1** = **Intervu.Probability**.

Source 1 Stop should be set to about **7 MHz**; a **Data 1** range of **0%** to about **100%** on a linear scale is useful for this view.

Jitter Histogram

The jitter histogram view displays the probability distribution of the amplitude of the jitter signal.

The width of the histogram represents the peak-to-peak jitter amplitude. The breadth of the display near its mid-section is indicative of the average jitter amplitude.

A jitter signal with low average jitter will be represented by a high probability of near-zero values. Signals with high average jitter are represented by values falling into bins farther away from zero.

Squarewave jitter will tend to produce a strong pair of peaks at the positive and negative peak jitter amplitudes, with a low amplitude area between them. Sinewave jitter will also produce a graph with two peaks, but the curve between them will follow a gentle arc. Random jitter histograms will vary from acquisition to acquisition, while jitter dominated by a coherent signal will tend to be more consistent.

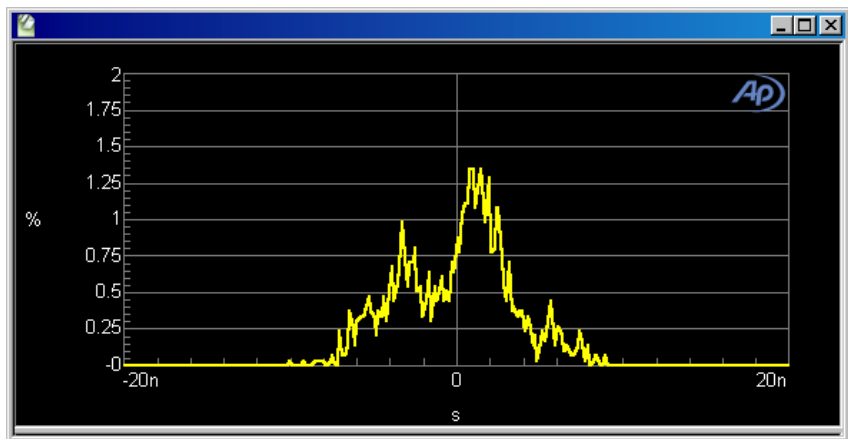

Figure 160. Digital Interface Analyzer jitter probability.

As indicated in Figure 151, this view requires these Sweep settings:

- **Source 1** = **Intervu.Jitter**, and
- **Data 1** = **Intervu.Probability**.

An initial **Source 1** range should be about ± 50 ns. **Data 1** should be set on a linear scale, with **0%** at the bottom, and a top value between a few percent up to **50%**.

When comparing histograms to the DIO panel jitter meter, remember that the DIO panel meter calibration is in terms of peak or average values, while the Digital Interface Analyzer jitter calibration is in terms of rms values.

InterVuMenu.atsb

Audio Precision Technical Support have written an AP Basic macro which acts as a simple and powerful “front end” to access the different Digital Interface Analyzer views.

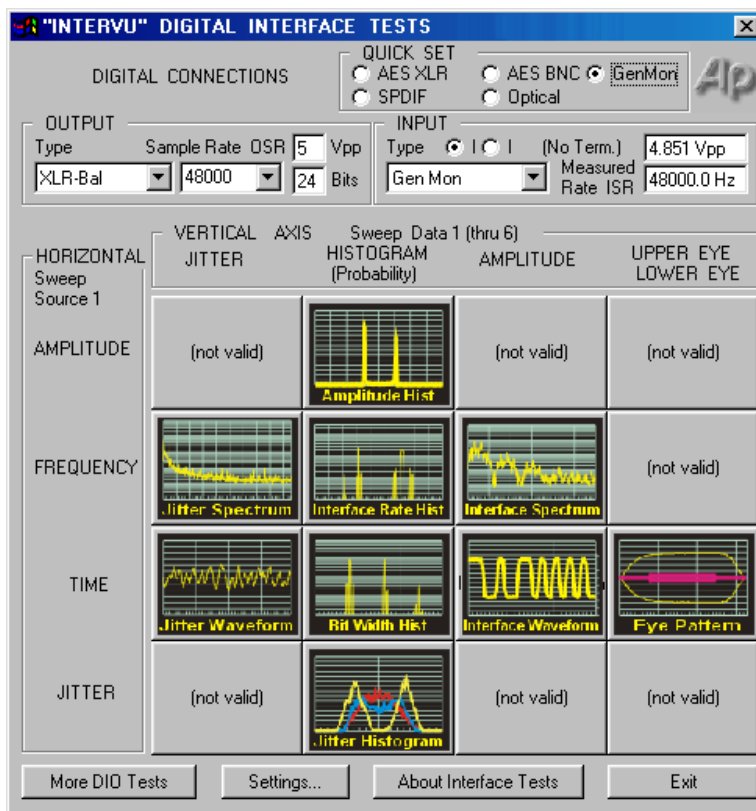
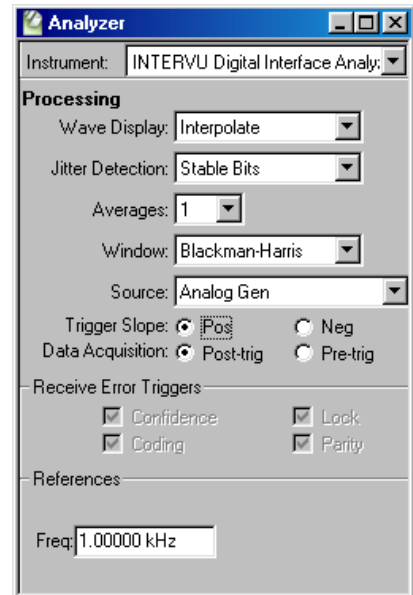

Figure 161. InterVuMenu.atsb menu screen.

InterVuMenu.at5b provides a graphical user interface (shown above) that loads a selection of sample tests that can be viewed as an introduction to the Digital Interface Analyzer, or that can be modified and saved for your own interface measurements.

Digital Interface Analyzer panel settings

Figure 162. The Digital Interface Analyzer panel.



Wave Display processing (Time Domain view only)

Figure 163. Digital Interface Analyzer panel Wave Display selections.

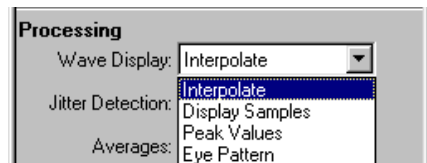

Four modes are available in the Digital Interface Analyzer for processing the amplitude-versus-time relationship of a sampled signal before displaying the waveform. These modes are applicable only to time domain (oscilloscope) views and have no effect on Digital Interface Analyzer spectrum analysis or histogram views.

The display processing setting determines how the data is modified for display when the spacing of the sweep points is different from the spacing of sample points in the acquisition.

The four modes available in the **Wave Display** field are:

- **Interpolate**
- **Display Samples**
- **Peak Values**
- **Eye Pattern**

Interpolate, **Display Samples**, and **Peak Values** offer the same wave display processing as do those choices in the **Spectrum Analyzer**.

Interpolate

When **Interpolate** is selected the DSP compares the density of sweep points requested with the density of sample points available in the acquisition, for the time span of the current sweep and graph.

If the requested points are much fewer than the acquisition points, the DSP uses a bipolar peak sensing mode to eliminate potential graphic aliasing problems; otherwise, it interpolates.

In the bipolar peak sensing mode, the signal waveform is not faithfully represented but is replaced with an approximation indicating the positive and negative peak excursions of the signal. See **Graphic Aliasing** on page 176.

If you use the graph **Zoom** and **Zoomout** commands, the time span represented on the graph changes. When **Interpolate** is selected, Wave Display automatically switches between bipolar peak sensing mode and interpolation mode for the best display.

The **Interpolate** selection produces a much more accurate display of the signal waveform than the **Display Samples** mode when the signal frequency is high (such as sample rate/100 or higher).

Display Samples

When **Display Samples** is selected, for each display point requested the DSP sends the amplitude of the nearest-in-time acquired sample to the computer for plotting. Acquisition points may be repeated or dropped, depending upon the relationship of acquisition point density to display point density.

When the signal frequency is low compared to the sample rate, this may produce an acceptable representation of the original signal waveform. At high signal frequencies, the waveform may be entirely unrecognizable in the **Display Samples** mode because of graphic aliasing (see page 176). **Interpolation** mode should normally be used in this case.

Peak Values

When **Peak Values** is selected, the DSP searches all sample amplitudes in the acquisition buffer between each pair of X-axis time values plotted, and sends to the computer for plotting the largest positive value in that span.

Since all sample values are examined, no signal peaks can be missed.

Eye Pattern

When **Eye Pattern** is selected, an entirely different sort of processing takes place in the DSP. **Eye Pattern** overlays many one-UI-segments of the acquired data on top of one another.

Following acquisition of the digital interface signal and extraction of an average clock signal from it, the worst-case (nearest to 0 V) amplitude is determined for each time increment relative to the beginning of each data cell. These values are plotted when **Intervu.Upper Eye Opening** and **Intervu.Lower Eye Opening** are selected as **Data 1** and **Data 3** parameters, resulting in a plot of the worst-case inside of the eye.

See page 192 for more information on the eye pattern.

*The **Intervu.Upper Eye Opening** and **Intervu.Lower Eye Opening** selections will not be available in the Data browser unless **Eye Pattern** is selected in the Wave Display field on the Digital Interface Analyzer panel. Conversely, if **Eye Pattern** is selected, conventional amplitude vs. time displays will not be available.*

Jitter Detection

Figure 164. Digital Interface Analyzer panel Jitter Detection selections.

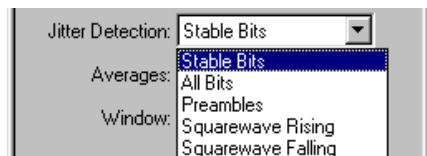

The Digital Interface Analyzer is capable of measuring jitter both on AES3/IEC60958 interface signals and on simple squarewave clock signals typically used in ADCs and DACs. The **Jitter Detection** interface signal selections are:

- **Stable Bits**
- **All Bits**
- **Preambles**

The **Jitter Detection** squarewave selections are:

- **Squarewave Rising**
- **Squarewave Falling**

These modes are described in the following sections.

AES3/IEC60958 Jitter Detection

The AES3/IEC60958 digital interface encodes two channels of digital audio into a single serial data stream. The serial signal consists of 32 cells (bits) per subframe and two subframes (left and right channels) per frame, for a total of 64 data cells per frame.

The frame rate is equal to the sample rate of the embedded audio.

There are 64 cells (bits) in a complete frame, and the cell rate is 1/64 the audio sample rate. The first four cells of each subframe are the preamble. The preamble always starts with a 3 UI (1.5 cell) wide pulse followed by sequences of 1 UI, 2 UI, and 3 UI pulses which are different among the three possible preambles. See Appendix B for more information on the serial digital interface signal.

An ideal pulse train would have regular transitions at exactly equal intervals corresponding to a master clock frequency. Jitter is the difference in timing of actual transitions of the pulse train from the instants when the transitions should theoretically have occurred. Therefore, jitter measurements require a stable, ideal clock signal to use as a reference for comparison of the actual transition times.

Part of the Digital Interface Analyzer's acquisition and processing of the digital interface signal involves reconstruction of an ideal clock for use as the reference for jitter measurements. The first three choices in the **Jitter Detection** field select the transitions at which the clock timing is compared to the interface signal.

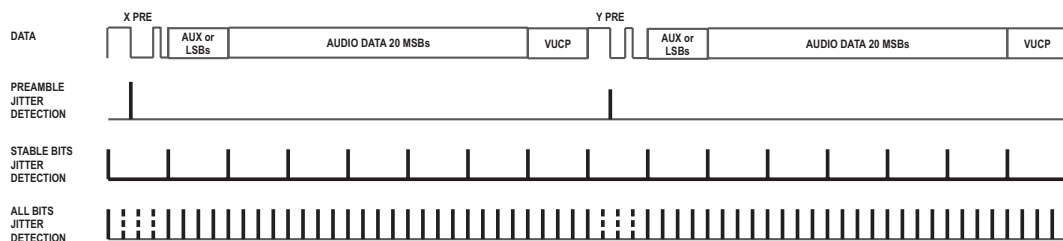

Figure 165. Digital Interface Analyzer Jitter Detection Selections

Stable Bits

The **Stable Bits** selection derives the stable reference clock at 1/4 the actual cell (bit) rate, which is 8 times the audio sample rate. **Stable Bits** is synchronized to the beginning transition of the preamble. If **Stable Bits** is used, the upper jitter detection frequency limit is reduced by 4:1 compared to **All Bits**. This provides an analysis frequency range of approximately 380 kHz at a 48 kHz sample rate.

Stable Bits and **Preambles** will result in the lowest residual measurement jitter. **Stable Bits** will be sensitive to all sources of jitter in a typical system, including jitter induced on an interconnect cable.

All Bits

The **All Bits** selection derives the stable reference clock at the actual cell (bit) rate, which is 64 times the audio sample rate. **All Bits** provides the maximum jitter detection analysis frequency range of approximately 1.5 MHz at a 48 kHz sample rate.

Preambles

The **Preambles** selection uses the average rate of the trailing edge of the first 3-UI-wide pulse in each preamble as the stable clock reference. Signal transitions at the same point are compared to that average reference to obtain jitter values for display. Since this derived reference clock rate is low (only twice the audio frame rate), the effective jitter measurement bandwidth equals the audio frame rate (sample rate) when **Preambles** is selected.

Preambles and **Stable Bits** will result in the lowest residual measurement jitter. Since the 3-UI pulse in a preamble is the most robust portion of the digital interface signal and is least affected by reduced bandwidth in the cable or system, **Preambles** will be relatively immune to cable effects and will be dominated by jitter in the source.

*The filter algorithm used for the **Wave Display: Interpolate** setting requires seven samples of input signal before displaying an output. This may make the jitter vs. time display show zeros for the first few microseconds.*

Squarewave (Converter Clock) Jitter Detection

In addition to measuring jitter on an AES3 or IEC60958 digital interface signal, the Digital Interface Analyzer can also measure jitter on any squarewave connected to the digital input connector, for a range of 5 kHz to 15 MHz. This feature permits measurement of jitter directly on the clock signal of ADCs and DACs. The waveform of the jitter may be displayed in

the time domain view, or a spectrum analysis of the jitter may be performed using the frequency domain view.

Select **Squarewave Rising** to measure jitter on rising edges of the signal and **Squarewave Falling** to measure on falling edges.

Averages (spectrum view only)

Figure 166. Digital Interface Analyzer panel Averages selections.

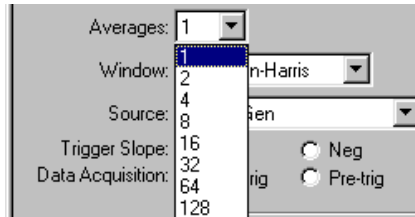

The Digital Interface Analyzer enables you to average the results of multiple acquisitions for frequency domain (spectrum) displays, in order to reduce the variance of noise and to make coherent signals stand out more clearly. The **Averages** field selects the number of acquisitions to be averaged, from **2** to **128**. A selection of **1** disables averaging.

FFT Windows for the Digital Interface Analyzer

Figure 167. Digital Interface Analyzer panel Window selections.



The Digital Interface Analyzer has several FFT windowing functions available for its frequency domain views, listed here:

- **Blackman-Harris**

The **Blackman-Harris** window provides a good trade-off between a window's ability to separate closely spaced spectral peaks and its ability to discriminate between moderately-spaced spectral peaks that are quite different in amplitude. Depending on whether or not the tone being measured is centered in the bin, there can be as much as 0.8 dB of error in the amplitude measurement.

- **Hann**

The **Hann** window provides good selectivity near the top of the main lobe (about -6 dB one bin away from center and about -30 dB two bins away), with no sidelobes. Its skirts more than 3 bins off center are not as steep as the **Blackman-Harris** window. The **Hann**

window causes approximately -1.5 dB maximum amplitude error due to window attenuation, if the signal is at the extreme edge of the bin.

- **Flat-Top**

The **Flat-Top** window provides measurements accurate to a few hundredths of a decibel for any spectral peak, but sacrifices selectivity for closely spaced tones.

- **Equiripple**

The **Equiripple** window has the narrowest main lobe width for a given maximum sidelobe depth. The main lobe is approximately 12 bins wide; that is, the first null is about six bins from the main lobe center. The first sidelobe, which is also the highest, is -147 dB from the main lobe. The maximum amplitude error with a signal at the bin boundary is about 0.5 dB.

- **None**

The **None** selection (sometimes called a rectangular window) does not apply any window function before the FFT. This mode is normally used only with synchronous signals; it is not generally useful for non-synchronous signals since energy will be spread across the entire spectrum unless the signal is exactly at bin center. The maximum amplitude error due to the rectangular window attenuation is about 4 dB.

General purpose spectrum analysis applications, such as displaying the interface signal spectrum, can use the **Blackman-Harris** window. When making FFT-based amplitude measurements of a discrete-frequency jitter component, the **Flat-Top** window should be used.

See the discussions of FFT windowing in Chapter 11 and in Appendix C for more information on the window shapes and their relative advantages and disadvantages.

The amplitude calibration for FFT spectrum analysis of jitter is in terms of the rms value of the jitter signal, such that a 1 kHz sinewave jitter signal measured at 10 ns peak on the DIO panel and displayed as a waveform of 20 ns peak-to-peak in waveform display mode will have an FFT peak at 1 kHz of about 7 ns (rms = peak \times 0.707).

Trigger Source

Figure 168. Digital Interface Analyzer panel Trigger Source selections.

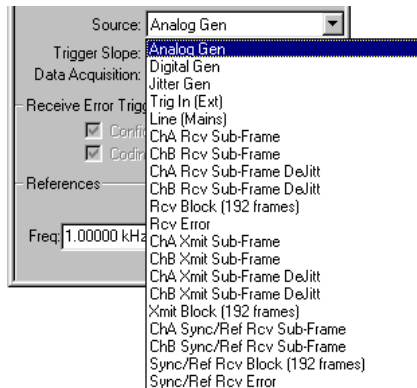

The Digital Interface Analyzer has an extensive trigger source list with the additional capability of triggering on up to four error conditions from either the digital input or the SYNC/REF input. These selections are identical to the choices on the Main Trigger panel; both panels control the same functions interactively. See **Main Trigger panel** on page 345 in Chapter 22 for a detailed description of every trigger source.

When **Go** is pushed, the timing of the beginning of the Digital Interface Analyzer acquisition is determined by the **Trigger Source** and **Receive Error** selections, the **Trigger Slope** buttons and the **Data Acquisition** buttons. The various **Trigger Source** choices include several points in the digital interface from the received digital input, the transmitted digital output or the Sync/Ref received input; from an external clock reference, the AC mains frequency and internal generators. The trigger from the digital interface signals can be extracted from the X- and Z-preambles (**Channel A subframe**), the Y-preambles (**Channel B subframe**) or the “block” Z-preambles (**Block 192 frames**).

Most of these alternative triggering sources will not cause any difference in the display of either spectrum analysis or waveform display of the jitter signal, or of spectrum analysis of the interface signal waveform. The differences will be seen only when displaying the interface signal waveform (time domain) with a narrow span (a few microseconds) between the **Source 1 Start** and **Stop** times so that the 3-UI, 2-UI, and 1-UI pulse widths that make up the preamble can be distinguished.

On the various preamble trigger sources, the trigger operation is such that the trailing edge of the first 3-UI pulse of the preamble occurs nominally at time zero. The first information displayed after time zero in these cases will be the remaining 5 UIs of the selected preamble, followed by the first bit in the data area. Depending on the nature of the interface signal,

that could be the LSB of the audio signal if full 24-bit resolution audio is transmitted, or the beginning of the 4-bit Auxiliary data area if audio is restricted to 20 bits or fewer.

The transmit preamble selections have the same triggering characteristics. This triggering selection permits measurement of time delay through a digital device or system under test.

The Transmit and Receive Block selections cause signal to be acquired at the first Channel Status Block Preamble transmitted or received.

The Receive Block trigger is delayed by two full frames by the AES receiver.

The Jitter Generator signal triggers at every cycle of the sinewave signal generated by the DIO jitter generator. This selection provides a stable display of the received jitter waveform when measuring through a digital device.

Triggering for squarewave acquisitions

None of the serial digital interface trigger sources (receive and transmit block, error and sub-frame sources) is useful when measuring squarewave jitter.

For stable triggering on a squarewave signal, split the connection with a BNC “T” adapter and connect the two resultant lines to the ATS-2 DIGITAL INPUT and the TRIG IN rear panel connection. Select **Trig In (Ext)** as the Trigger Source.

The **Jitter Generator** trigger selection works only when AES3 Jitter on the DIO panel is turned on. This trigger mode can be useful when looking at jitter on a squarewave clock that is derived from an AES3 signal fed from ATS-2’s digital generator output.

Trigger Slope

*Figure 169. Digital Interface Analyzer
Trigger Slope & Data Acquisition buttons.*



The **Trigger Slope** buttons allow you to select whether the Digital Interface Analyzer acquisition triggers on the positive-going (rising) or negative-going (falling) slope of the trigger waveform selected in the **Source** field.

Data Acquisition

The Digital Interface Analyzer data acquisition length is fixed at 1,572,864 samples, which, at the 80 MHz sample rate of the Digital Interface Analyzer ADC, gives an acquisition duration of 19.66 ms. The **Data Acquisition** buttons select whether the acquisition is the 19.66 ms before the trigger event, or the 19.66 ms after the trigger event.

See Figure 169.

Receive Error Triggers

Figure 170. Digital Interface Analyzer panel **Receive Error Trigger** selections.

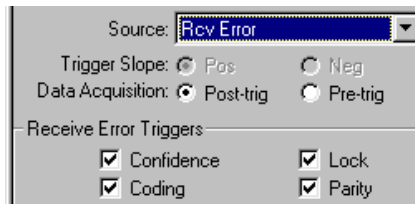

The receive error selections cause data to be acquired when the AES3 receiver of the DIO module detects one or more parity, coding, lock, or confidence errors. The checkboxes permit the selection of any or all these types of error to cause triggering.

Sync Error is identical to **Receive Error**, but pertains to a signal connected to the rear panel SYNC/REF IN connector rather than the front panel input connector.

Depending upon whether **Pre-Trigger** or **Post-Trigger Data Acquisition** was selected, the data in the buffer will precede or follow the first error detection.

References

Figure 171. Digital Interface Analyzer panel **References**.



The **Freq.** value serves as the reference for relative frequency units used in the Digital Interface Analyzer. Relative frequency units are useful for displaying the spectra relative to the interface sample rate or relative to the jitter frequency.

There are several choices of relative frequency units in ATS, including **F/R**, **dHz**, **%Hz**, **octs**, **decs**, **d%** and **dPPM**. These are available any

time that the Sweep **Source** or **Data** parameter is set to **Intervu.Frequency**. For a complete discussion of these units and their definitions see Appendix A.

Saving and Loading Interface Waveforms

As with other ATS tests, you can save the setup and results of any Digital Interface Analyzer test as an .ats2 test file. The acquired waveform in the Digital Interface Analyzer acquisition buffer, however, is not saved as part of a test. If you want to keep the acquired data record for further analysis, you must save it as an .aai (**A**udio **P**recision **A**cquisition **I**nterface) acquired waveform file.

When the Digital Interface Analyzer is selected as the Analyzer instrument, the **File > Open > Intervu Waveforms** and **File > Save As > Intervu Waveforms** menu commands become available.

These commands allow you to save a Digital Interface Analyzer (Intervu) acquisition waveform to disk as an .aai file, or to open an existing .aai (Intervu) file and load the waveform into the acquisition buffer.

Audible Monitoring in the Digital Interface Analyzer

It can be useful to listen to the audio on the digital interface signal being measured, enabling you to make a quick confidence check. It can also help you determine if the errors being measured correspond to the particular audible defect detected.

When the Digital Interface Analyzer is selected as the Analyzer instrument, the audio embedded in the digital interface signal appears at the **Source A** and **Source B** selections on the Headphone/Speaker panel and at the **SOURCE A** and **SOURCE B MONITOR OUTPUT** BNCs.

Chapter 13

The Multitone Audio Analyzer

Introduction

The Multitone Audio Analyzer is a DSP instrument selection on the Analyzer panel. It is an FFT-based analysis instrument for use with both analog and digital audio signals. Multitone is called “**Fasttest**” on instrument browser lists and in AP Basic macro references.

Figure 172. The Multitone Audio Analyzer panel.

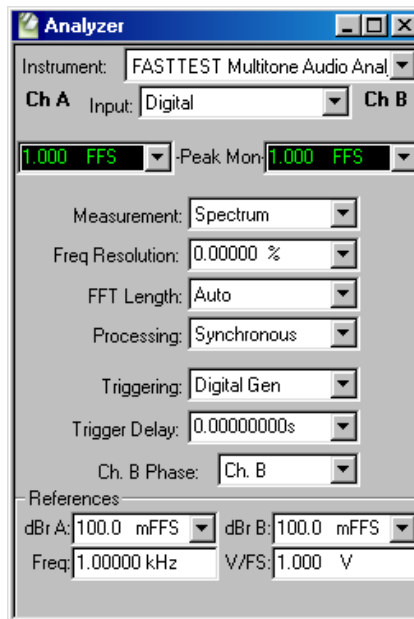

Overview: Multitone Testing

The Multitone Analyzer uses a synchronous FFT to analyze a special multitone waveform that is a combination of many sinewaves. Figure 173 shows the spectrum of a signal made up of 36 tones.

For more information about synchronous FFTs and other concepts used in FFT analysis, see Appendix C.

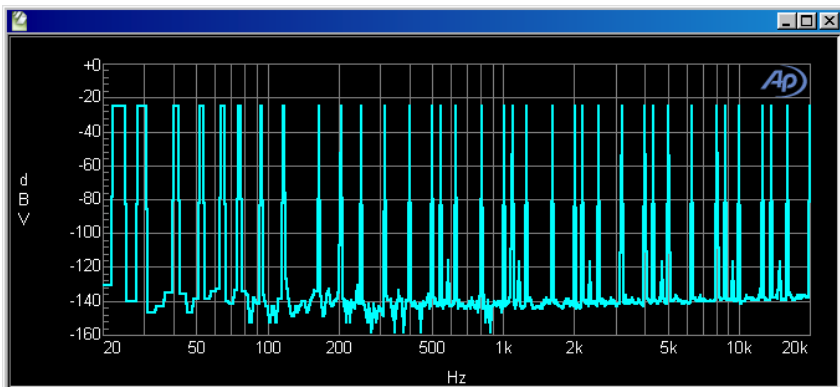

Figure 173. Spectrum View of Typical Multitone Stimulus Signal.

Although it can be output by either the Analog or the Digital Generators, a multitone waveform is generated in DSP and is designed so that all the sinewaves will be synchronous.

The multitone signal is applied to the DUT and an acquisition of the device's output is made for analysis. Since the waveform is synchronous, each sinewave falls only into its own bin, maximizing frequency resolution. Any harmonic distortion products created in the DUT will also be synchronous, and each of these products will fall into its own bin as well.

The FFT data can then be interpreted in several ways, extracting amplitude, phase, distortion, noise and crosstalk results. Multitone can provide detailed, accurate and very fast measurements using a short multitone “burst.”

The Multitone Analyzer normally provides a frequency domain (spectrum analyzer) view of the signal. A time domain (oscilloscope) view is also available but is rarely used.

Multitone Waveform requirements

A multitone test signal is a complex waveform, the combination of two or more sinewaves. There are typically from 3 to 30 or more tones in a multitone signal; to the ear, it sounds like a dissonant organ chord.

Figure 174. Example of multitone stimulus spectra.

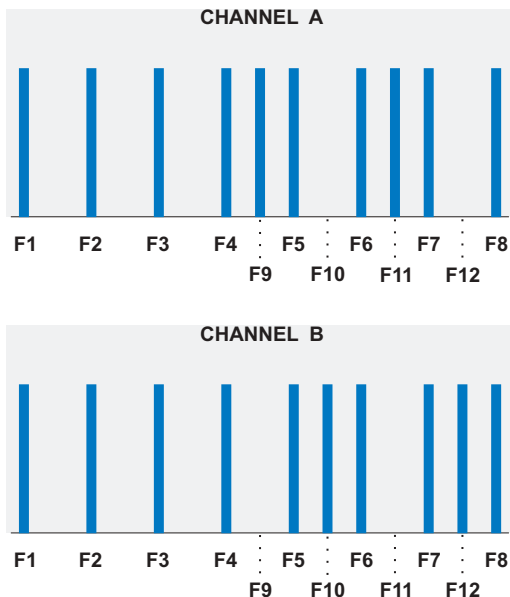

We will look at different types of multitone measurements in the next sections; for our example diagrams we will assume the use of the multitone stimulus signal diagrammed in Figure 174. This multitone example has ten tones on Channel A and ten on Channel B. For crosstalk measurements, two tones on each channel are unique (F9 and F11 on Channel A, and F10 and F12 on Channel B).

The number and approximate frequencies of the tones in a multitone waveform are determined by the type of test you are performing. If you are making a 1/3-octave spectrum analysis, for example, you would choose 31 tones, each very near to one of the frequencies specified for the standard ISO 31 test.

The exact frequencies selected for the 31 tones must each be synchronous for the record length of the FFT. This is accomplished by making each tone an integer multiple of a base frequency which is synchronous.

Sample multitone waveforms

In ATS-2, multitone waveforms are generated using the Arbitrary Waveform function in either generator, which loads and “plays” a waveform file

from disk. Many multitone waveform files (such as ISO 31) are included with ATS-2, ready to load and use.

Creating custom multitone waveforms

You can also create your own waveform files using the Multitone Creation Utility. See **Creating Multitone Waveform Files** on page 236.

Multiple Synchronous Tones in One Waveform

The lowest synchronous frequency for an FFT is the frequency for which one cycle fits exactly in the transform buffer, calculated by dividing the signal sample rate by the transform length in samples. For example, a sample rate of 48 kHz and a transform length of 8192 samples gives a base frequency of 5.859375 Hz. That frequency and all integer multiples of that frequency are valid tones to use in a 48 kHz multitone waveform being measured by an FFT analyzer using an 8192 sample acquisition.

Fortunately, if you decide to create custom waveforms, all these calculations are done for you by the Multitone Creation Utility. See page 236.

"Inside Information": Multitone Generator Settings

To make multitone analysis fast and consistent, the Multitone Audio Analyzer in ATS-2 requires information about the nature of the multitone file in use.

The Analyzer must “know” what tones are in the multitone waveform, the sample rate at which they were generated, etc. In most cases, this information is passed from the ATS-2 generator directly to the Multitone Analyzer with no user input needed.

This is not possible when the multitone waveform is being played from an audio tape or a CD, or if it is being transmitted from a remote location. In these cases, you must load a multitone waveform into one of the ATS-2 generators. This waveform must have the same characteristics as the multitone being used for the test. The audio output of the generator is not used, but the waveform information is sent to inform the analyzer of the multitone conditions.

The Multitone Audio Analyzer panel

Figure 175. Loading the *Multitone Audio Analyzer*.



To use the **Multitone Audio Analyzer**, first open the Analyzer panel. The Analyzer panel is a command selection on the Panels menu, and is also available by the keyboard shortcut **Ctrl+Y**, or by clicking the **Analyzer** icon on the Toolbar.



Now select **FASTTEST Multitone Audio Analyzer** from the list on the Analyzer panel. This loads the Multitone Audio Analyzer program into DSP.

Signal Inputs

Figure 176. *Multitone Audio Analyzer Signal Inputs*.

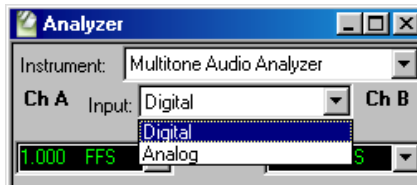

The **Input** field of the **Multitone Audio Analyzer** offers two signal input selections:

- **Digital**, and
- **Analog**.

These choices access the signals routed from the Digital Input/Output (DIO) panel or the Analog Input panel, respectively.

Digital signals are applied directly to the **Multitone Audio Analyzer** DSP; analog signals are first digitized by precision ADCs (selected on the Analog Input panel) before being applied to the **Multitone Audio Analyzer**.

To configure analog input connectors, range, coupling, select ADCs, bandwidth, etc., go to the Analog Input panel (see Chapter 6). To configure digital input connectors, digital input format and other aspects of interface, go to the DIO panel (see Chapter 7).

Peak Level Monitors

Figure 177. Multitone Audio Analyzer Peak Level Monitors.

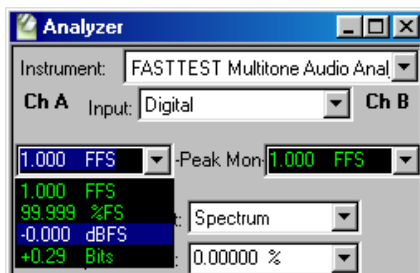

The two **Peak Mon** meters on the Multitone panel continuously display the peak amplitude of the digital signal as it is presented to the **Multitone Audio Analyzer**. Only digital domain units (**FFS**, **dBFS**, **%FS**, or **bits**) are available for these meters.

The primary purpose of the peak monitors is to avoid overload of the input analog-to-digital converters (ADCs). When signal is being acquired from the analog source and **Auto Range** is in use on the Analog Input panel, ADC over-range should never be a problem. If any of the Analog Input range controls is fixed, you must verify that the maximum signal amplitude never exceeds digital full scale.

Multitone Measurements

Once a multitone signal has been routed through the DUT, an acquisition is made and an FFT is performed. The **Measurement** field selects the type of post-processing performed on the FFT results before they are displayed or compared to limits.

Figure 178. Multitone Measurement selections.

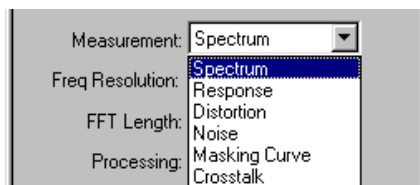

Frequency Domain Views by default

The display for each of these measurement modes is by default a frequency domain view, plotting the results on amplitude vs. frequency graph. **Spectrum** and **Response** measurement results can also be displayed as phase vs. frequency plots by choosing a **Fasttest.Phase** instrument in the Sweep **Data** browser.

Spectrum

Figure 179 shows a diagram representing an FFT spectrum display of the signal at the DUT output, for our example multitone of Figure 174. Note that the illustration shows that the DUT has modified the response and has added noise and distortion to the signal.

Figure 179. Example of a multitone spectrum display.

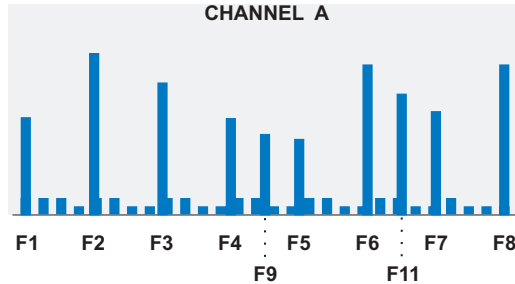

The ATS **Spectrum** Multitone Measurement selection provides a normal FFT spectrum display with no processing except for peak picking (see page 176) when necessary. Since **Spectrum** mode shows the amplitude (or phase, if selected) of every bin without discrimination, it is useful for verification of signal presence but not for analysis.

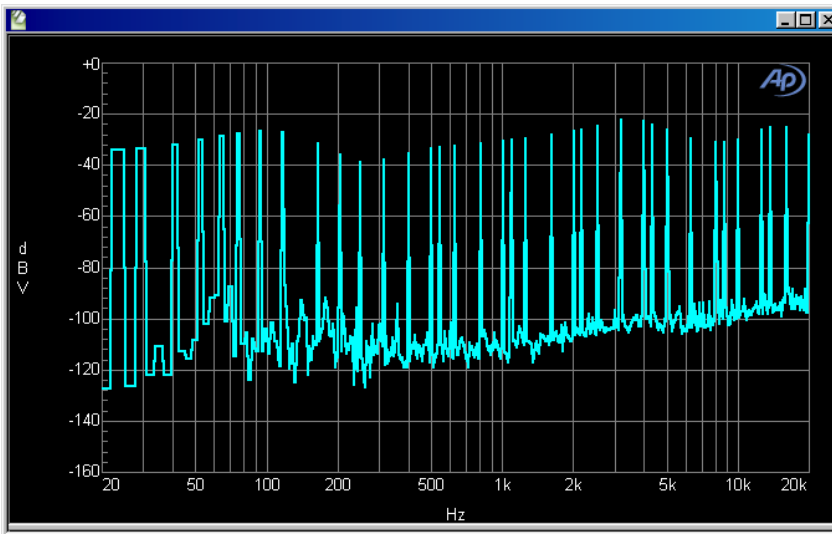

Figure 180. Typical Multitone **Spectrum** measurement.

Spectrum normally displays amplitude vs. frequency, but will show phase vs. frequency if **Fasttest.Phase** is selected as a Sweep **Data** instrument.

Response

Response mode displays a response curve drawn through the amplitude (or phase, if selected) measured in each of the bins that correspond to a stimulus tone in the multitone signal. This gives the frequency response (or phase response) of the DUT.

Figure 181. Example of a multitone frequency response graph.

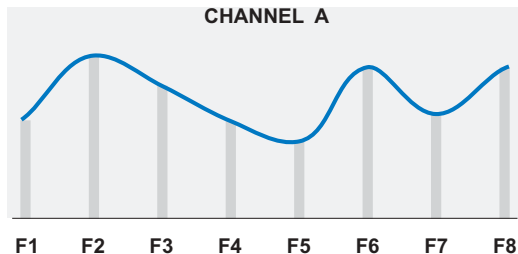

In the multitone frequency response example diagramed in Figure 181, the amplitude in each of the bins which are known to have tones is shown as a light gray line. The dark line represents the frequency response curve.

Figure 182. Example of a multitone phase response graph.

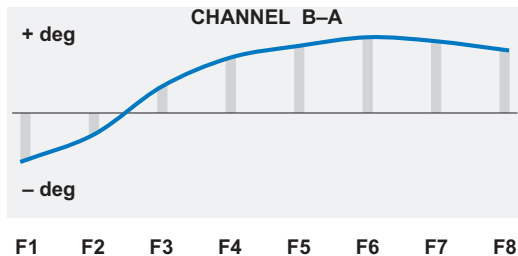

Response normally displays amplitude vs. frequency, but will show phase vs. frequency if **Fasttest.Phase** is selected as a Sweep **Data** instrument.

In the multitone phase response example diagramed in Figure 182, the phase in each of the bins which are known to have tones is shown as a light gray line. The dark line represents the phase response curve.

In ATS, you can measure either the absolute phase relative to the generator, or the phase difference between Channel B and Channel A. See Phase Measurements, page 230.

The ATS **Response** Multitone Measurement selection provides a response curve as shown in Figure 183.

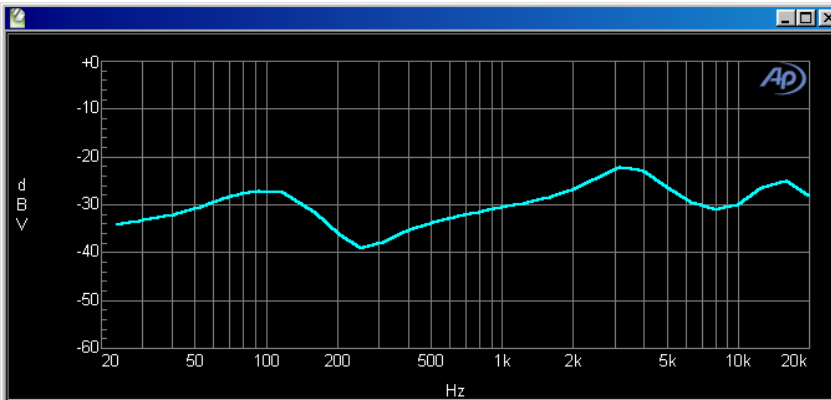
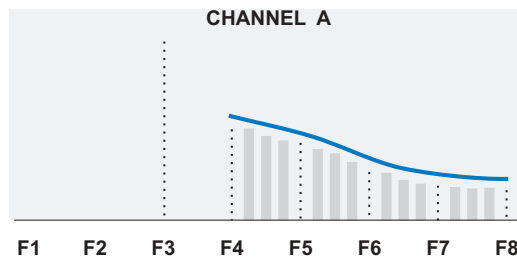

Figure 183. Typical Multitone **Response** measurement, amplitude vs. frequency.

Distortion

Figure 184. Example of a multitone distortion response graph.



In a conventional distortion test where only a single tone is in the stimulus, only that fundamental frequency needs to be removed. What's left is the total harmonic distortion and noise.

For a multitone distortion reading using our example waveform, the bins containing tones F1 through F10 are rejected from the reading, as shown by the dotted lines in Figure 184. The residual is the noise and distortion products, shown as light gray lines. The values in these residual bins are rss (root sum square) summed between sweep steps, and a distortion response curve (the dark line) is drawn through these results for display.

A typical display of an ATS Multitone **Distortion** measurement is shown in Figure 185.

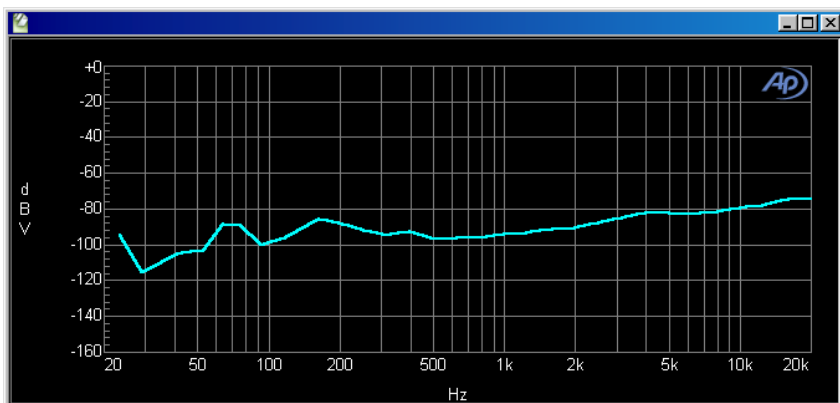
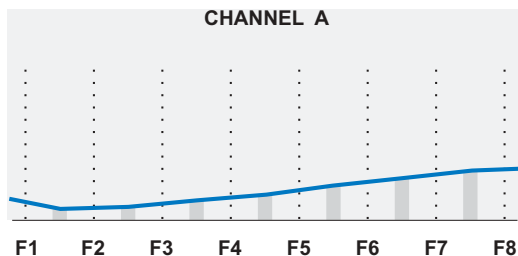

Figure 185. Typical Multitone *Distortion* measurement.

Noise

Figure 186. Example of a multitone noise response graph.



In many devices, noise is not constant but varies according to the applied signal. Multitone is the only technique that can measure noise in the presence of signal.

To measure noise without measuring the applied signal, the Multitone FFT Length must be set to twice the length of the stimulus waveform. In the ATS Multitone Audio Analyzer, this is accomplished when the FFT Length is set to **Auto**.

Under such conditions the analyzer frequency resolution is twice the resolution of the generated signal, with twice the bins of an FFT that matches the waveform length. The power in these “extra” bins is a measurement of the noise generated in the DUT in the presence of applied signal, excluding the signal itself. See the sidebar for more detail.

Odd bins only

In multitone tests, the length of the waveform and the length of the transform buffer are normally set to be the same; in our example, 8192 samples, giving a frequency resolution or bin width of about 5.86 Hz at a sample rate of 48 kHz.

For a measurement of noise in the presence of signal, the length of the transform buffer is set to be exactly twice the length of the multitone waveform. Under these conditions the FFT is still synchronous, but at 16384 samples, the frequency resolution has doubled to 2.93 Hz.

The effect of this is that any tone or product of a tone from the original 8192-sample-long multitone must fall only into alternate bins in the FFT, the “even” bins that are 5.86 Hz apart. The “in-between” or “odd” bins (shown in light gray in Figure 186) contain only noise. The result at each sweep step is twice the rss sum of the noise power in the odd bins between that sweep step and the step below it. A response curve (the dark line in Figure 186) is drawn through these results for display.

Why TWICE the rss sum? To take into account the unmeasured noise power in the skipped “even” bins in each measurement segment.

The ATS **Noise** Multitone Measurement selection provides a noise vs. frequency curve as shown in Figure 187.

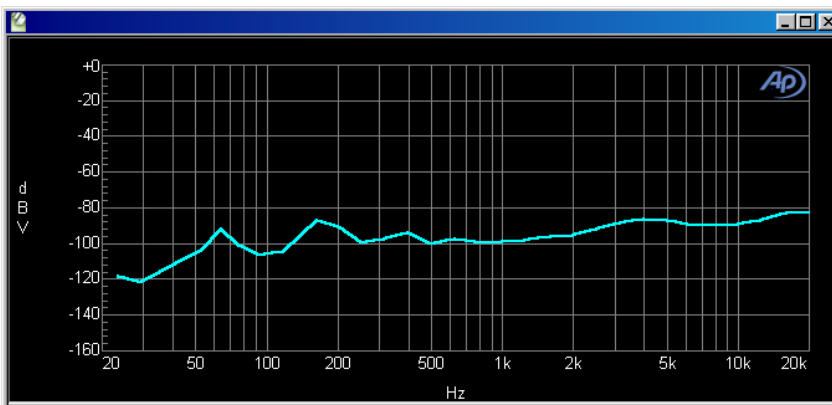
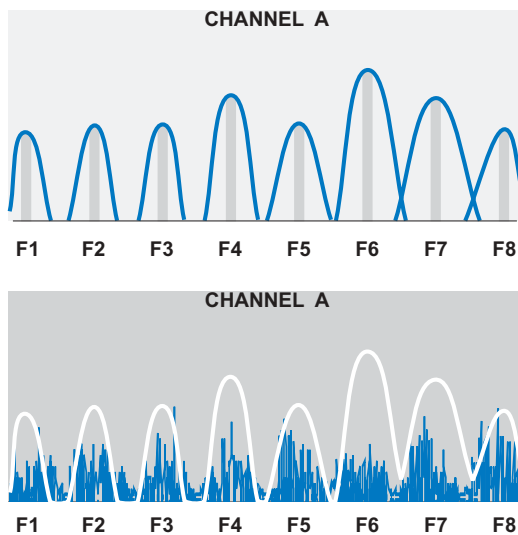

Figure 187. Typical Multitone **Noise** measurement.

In a DUT with no distortion, a Multitone **Distortion** measurement and a **Noise** measurement will provide essentially the same results.

Masking Curve

Figure 188. Example of a multitone masking curve analysis.



In a masking test, ATS determines the correct masking curve (the shapes of which vary with frequency) for every tone to be evaluated, at the levels they are received from the DUT. The dark lines in the upper illustration of Figure 188 are an example of this.

Masking

Masking is a characteristic of human hearing. A loud sound close in frequency to a quieter sound “masks” the quieter sound; under these conditions, we perceive only the louder sound. For example, faint noise or distortion products centered in a range around 7 kHz might be audible in an otherwise quiet signal, but if a louder 7 kHz tone is added to the signal, the noise will be masked.

The effects of masking vary with frequency and level. Curves have been determined which quantify masking effects at different frequencies and levels for the average listener.

It is important to understand and measure masking effects to evaluate under what conditions noise is audible in a dynamic signal. The Multitone Audio Analyzer tests low-bit-rate perceptual coders with multitone signals by summing quantization noise and distortion and comparing it to an embedded psychoacoustic model of the frequency masking effect.

A composite curve is created which represents the total masking which would be in effect for the tones selected. You can then append to this

curve the original data in a spectrum or distortion view to produce a graph like the lower illustration in Figure 188.

You can also save the masking curve data as a limit file and attach it to other tests.

Crosstalk

Figure 189. Example of multitone crosstalk response graphs.

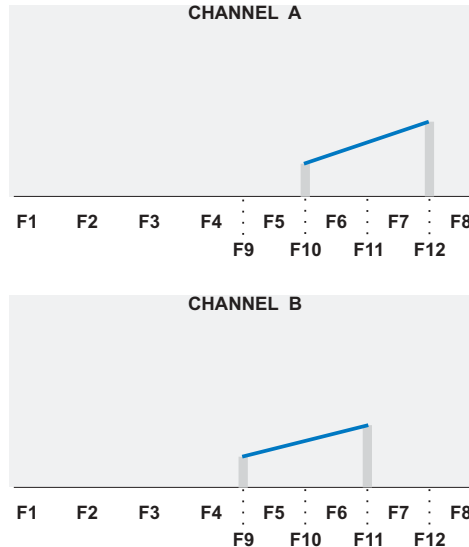

Crosstalk depends on the presence of at least two unique tones in each channel, tones that are not present in the multitone waveform for the opposite channel.

In our example, F9 and F11 exist only on the A channel, and F10 and F12 exist only on B. To measure crosstalk from B to A, the Multitone Analyzer rejects all bins but the ones at F10 and F12. In the same way, crosstalk from A to B is measured by rejecting all bins but the ones at F9 and F11. The only signal in these bins will be crosstalk from the opposite channel. A response curve (the dark lines) are drawn through these amplitudes on each channel for display.

To characterize crosstalk across a range of frequencies, use multitone waveforms with a range of unique crosstalk tones.

The ATS **Crosstalk** Multitone Measurement automatically determines from the two generator waveform buffers which frequencies are unique to each channel. Then **Crosstalk** measures the amplitude on the opposite (non-driven) channel at each of those unique tones, providing crosstalk response curves as shown in Figure 190.

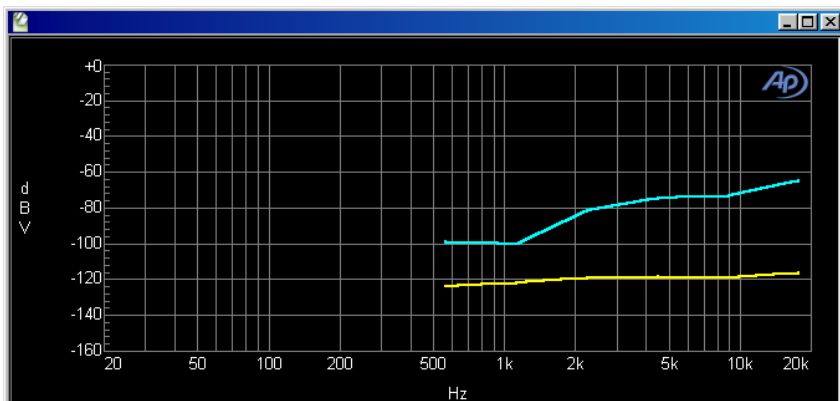

Figure 190. Typical Multitone **Crosstalk** measurement.

Time Domain View

A time domain view is also available, showing the multitone waveform as an oscilloscope-style trace. The time domain view does not change with measurement mode selection. This view can be useful to observe the peak levels or crest factor of your multitone signal.

Click the **Spectrum/Waveform** toggle button or choose **Fasttest.Time** in the Sweep **Source 1** browser to enable the time domain view. See the table on page 233 for a listing of available and valid Multitone display modes and their results.

Frequency Resolution

Figure 191. The **Multitone Freq Resolution** field.

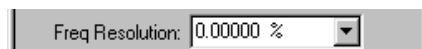

The **Freq Resolution** control has two functions:

- Setting Multitone triggering frequency resolution.
- Setting root-sum-square (rss) summing frequency resolution in **Response** and **Distortion** measurement modes.

Setting Multitone triggering resolution

The Multitone Audio Analyzer has the ability to recognize a specific multitone waveform in the received signal by comparing the signal to the multitone file information passed from the ATS-2 generator. When the frequencies in the received signal match the generator frequencies, the ana-

lyzer recognizes the incoming multitone and issues a trigger to begin the acquisition and analysis procedure.

If Frequency Resolution has been set to zero and the frequency of the incoming signal has been shifted, Multitone will not recognize the waveform and will not trigger. A setting greater than zero in the Frequency Resolution field broadens the range of acceptance, so that Multitone will recognize and trigger from a frequency-shifted waveform. The maximum value is limited to 13%.

Setting frequency resolution for rss summing

Speed variations such as flutter spread the stimulus tones into close groupings of modulation products (sidebands). For more accurate measurements the energy in these sidebands must be considered.

The Frequency Resolution control sets the range of frequencies that are:

- included in an rss sum at each specified tone in **Response** and **Crosstalk** measurement modes; or
- excluded from the measurement at each specified tone in **Distortion** and **Noise** measurement modes.

A Frequency Resolution setting of **0%** returns the amplitude of the bin at the stimulus tone. Greater Frequency Resolution settings widen the range to allow inclusion or exclusion of the amplitudes of the close-in modulation products. The maximum widening of resolution is limited to 13%.

FFT Length

Figure 192. Multitone FFT Length selections.

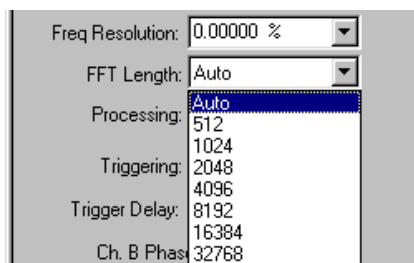

The Multitone FFT Length field value controls the record length used when signal is acquired or a re-transformation is initiated. Longer transform lengths produce greater frequency resolution (more bins) in the resulting FFT, but require longer times to acquire and transform the signal.

Auto is the recommended selection. The **Auto** selection automatically sets the acquisition buffer and transform length to be exactly twice the

length of the arbitrary waveform presently loaded into the generator. This condition is essential for the **Noise** measurement function of the Multitone Audio Analyzer, and will also work well with any other Multitone test.

One of the seven fixed FFT lengths can also be selected. For Multitone to provide useful results, a selected fixed FFT length must be an integral multiple of the multitone waveform length. See Appendix C for more information on transform length for synchronous FFTs.

Processing

Figure 193. *Multitone Processing selections.*

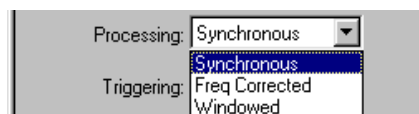

The Processing choices for the Multitone Audio Analyzer are

- **Synchronous**
- **Freq Corrected**
- **Windowed**

Synchronous is the normal selection. **Synchronous** processing uses no window function and assumes that the generator tones are synchronous with the FFT length.

Freq Corrected is also a synchronous selection, but, similar to the **None, move to bin center** selection in the FFT Analyzer, this choice first corrects the frequency of the received signal by up to $\pm 4\%$ in an attempt to make the generator tones and the FFT length synchronous. This process takes more time than the **Synchronous** selection, and should be used only if the received signal has passed through a device that has slightly shifted its frequency.

Windowed applies a Hann window to the signal before transformation. This choice offers poorer selectivity than the two synchronous selections, and should only be used in situations where frequency shifting of the multitone signal has occurred and the use of the **Freq Corrected** mode offers insufficient frequency-shifting range or is otherwise undesirable.

Triggering

Figure 194. *Multitone Triggering selections.*

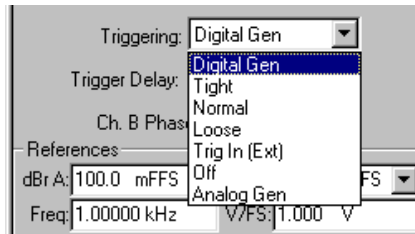

The Multitone Audio Analyzer has seven triggering modes:

- **Off**
- **Digital Gen**
- **Analog Gen**
- **Tight**
- **Normal**
- **Loose**
- **Trig In (Ext)**

Off

Off results in untriggered or free-running operation. Acquisition and processing begin as soon as the **Go** button pushed.

Digital Gen and Analog Gen

The ATS-2 generators issue a trigger when the first sample of the Multitone waveform is generated. When **Digital Gen** or **Analog Gen** is selected, the Multitone Analyzer triggers from that source. **Digital Gen** and **Analog Gen** triggers provide consistent, stable operation and are the recommended triggering modes for locally-generated multitones.

The generator triggering modes are the only triggering modes that will return a correct result in an **Independent** phase measurement.

Tight, Normal and Loose

Tight, **Normal** and **Loose** triggering are for use when receiving a multitone waveform that is not currently being output from an ATS-2 generator—a waveform from an audio recording or a distant transmitter, for example. As mentioned before, the same multitone waveform that is being received must be loaded into the generator. The Multitone Analyzer com-

compares the incoming signal with the multitone waveform in memory to decide when to begin its acquisition.

Normal is the recommended setting for receiving an external multitone. If the signal is degraded and will not trigger properly, **Loose** relaxes the triggering criteria and may provide more consistent triggering. **Tight** enforces the criteria more strictly, and will provide better triggering when the multitone burst is very short, or when program material on the line might cause false triggering.

Trig In (Ext)

The **Trig In (Ext)** triggering selection responds to a trigger event at the Trig In (Ext) connector on the ATS-2 rear panel.

Trigger Delay

Audio processors (compressors, limiters, etc.) require time to stabilize following any change of level, such as between the multitone burst and the preceding program material.

If you need to allow processors in an audio chain to stabilize before measurement, a delay can be inserted between recognition and acquisition of the signal. The **Trigger Delay** field controls the interval between initial recognition of the incoming multitone signal and capture of the portion of signal which will be analyzed.

If you set a **Trigger Delay**, be sure that the duration of the multitone burst transmitted is increased by the same amount over the normal minimum burst duration; see **Multitone Minimum Duration Requirements** on page 232.

Phase Measurements

Figure 195. Multitone Ch. B Phase selections.

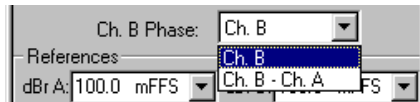

By default, Multitone results are displayed as amplitude vs. frequency plots. To measure phase, select **Fasttest.ChA Phase** or **Fasttest.ChB Phase** (or both) as a Sweep **Data** instrument.

Most multitone waveforms (and all of the multitone samples provided with ATS-2) have had the phase of each tone shifted randomly to reduce the crest factor of the waveform. In ATS-2 this process is called “phase randomization.” Waveforms that have had this process applied will not return

valid phase results, with one exception mentioned below in **Channel B Phase**.

You can create your own multitone waveforms for phase tests without randomizing the phase by unchecking the “Minimize Crest Factor” checkbox on the Multitone Creation Utility dialog box. Such waveforms will have a high crest factor. See **Creating Multitone Waveform Files** on page 236.

Channel A Phase

When **Fasttest.ChA Phase** is selected for Sweep **Data** in a Multitone test, the readings are of the absolute phase of the acquired Channel A multitones relative to the corresponding tones at the ATS-2 generator. The multitone signal must originate from a local ATS-2 generator, and the Multitone Analyzer must be set to trigger from that generator. The tones must not have had their phases randomized.

Channel B Phase

When **Fasttest.ChB Phase** is selected for Sweep data in a Multitone test, you can select one of two phase measurements from the Ch. B Phase field:

- **Ch. B**

This selection measures the absolute phase of the acquired Channel B multitones relative to the corresponding tones at the ATS-2 generator. The multitone signal must originate from a local ATS-2 generator, and the Multitone Analyzer must be set to trigger from that generator. The tones must not have had their phases randomized.

- **Ch. B – Ch. A**

This “B minus A” selection measures the phase of the Channel B multitone signal tones relative to the corresponding tones in the Channel A signal. For this to be meaningful, the waveform for both Channel A and Channel B must be identical. Use a mono multitone waveform, filename extension .agm.

Since a mono waveform has identical tones on each channel, it is permissible to have used the “Minimize Crest Factor” feature in the creation of this file. The phase randomization introduced will be the same on both channels, and the relative phase measurement will be valid.

References

Analog and digital amplitude and frequency references for the Multitone Audio Analyzer are the same as for other Analyzer instruments. See **Ana-**

lyzer Analog References on page 151 and **Analyzer Digital References** on page 152.

Other Considerations

Multitone Minimum Duration Requirements

The minimum duration of multitone signal which must be present to guarantee analyzer triggering depends primarily upon the generator record length used to create the multitone signal. The required signal duration also varies inversely with the sample rate at which the signal was generated (and, in the case of digital inputs, will be received). Small variations in required duration are also a function of whether the signal is acquired from an analog or the AES3 serial digital source, and whether or not the frequency correction function of the **Processing** field is in use.

Generator Record Length	Minimum Burst Duration	Lowest Freq. & Minimum Freq. Spacing
16384	2.1 s	2.92 Hz
8192	1.05 s	5.86 Hz
4096	520 ms	11.7 Hz
2048	260 ms	23.4 Hz
1024	135 ms	46.9 Hz
512	70 ms	93.7 Hz
256	40 ms	187.5 Hz

*Table 1. Generator record length versus attributes.
Conditions are 48 kHz sample rate and use of **Freq Corrected**.*

Table 1 shows the minimum multitone signal duration as a function of generator record length in samples, assuming a 48 kHz sample rate and the use of **Freq Corrected**. Multiply the values shown by 0.5 for a 96 kHz sample rate, by 1.088 for a 44.1 kHz sample rate, and by 1.50 for a 32 kHz sample rate.

If a Trigger Delay is set, the amount of the delay must be added to the minimum multitone signal duration.

Invalid Multitone Readings

When data are not available for graphing or tabular display for the selected combination of Multitone Analyzer display mode and Sweep Source instrument, the reading will be invalid. The following chart lists the readings available for each combination:

Available Multitone Readings by Measurement and Sweep Type				
	Normal Sweep		Table Sweep	
	Amplitude	Phase	Amplitude	Phase
Spectrum	Peak-picked bin magnitudes	Nearest bin phase	Nearest bin magnitude	Same as Normal Sweep
Response	Interpolated rss magnitude	Interpolated phase	Same as Normal Sweep	Same as Normal Sweep
Distortion	rss from previous sweep freq	Invalid	Same as Normal Sweep	Same as Normal Sweep
Noise	rss from previous sweep freq	Invalid	Same as Normal Sweep	Same as Normal Sweep
Masking Curve	Interpolated masking curve	Invalid	Same as Normal Sweep	Same as Normal Sweep
Crosstalk	Interpolated rss magnitude	Invalid	Nearest rss magnitude	Same as Normal Sweep

Table 2. Available Multitone Readings by Measurement, Amplitude and Phase results, and by Normal Sweep or Table Sweep operation.

Acquired Waveform Files

As with other ATS tests, you can save the setup and results of any Multitone Audio Analyzer tests as an .ats2 test file. The acquired waveform in the Multitone acquisition buffer, however, is not saved as part of a test. If you want to keep the acquired data record for further analysis, you must save it as an .aam (acquisition, mono) or .aas (acquisition, stereo) acquired waveform file.

Single-channel “mono” waveforms saved at different times can later be individually loaded into the two channels of the Multitone acquisition buffer to become “stereo” acquisitions for comparison in the time or frequency domains.

Saving Acquired Waveforms

Figure 196. ATS Multitone Audio Analyzer **Save Stereo Waveform** dialog box.

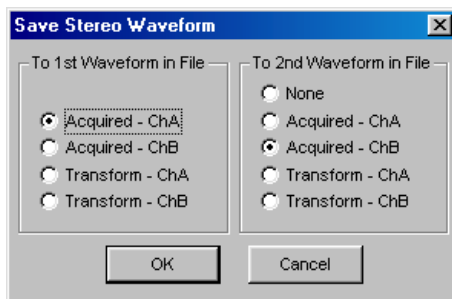

To save an acquisition, select the **File > Save As** menu command, choosing either the **Stereo Waveforms** (.aas) or **Mono Waveforms** (.aam) as the file type.

A stereo acquisition waveform file consists of two waveforms joined together into a single file; a mono acquisition waveform file contains a single waveform. To simultaneously save the waveforms from both acquisition buffer channels A and B, select the stereo choice. To save only one of the channels, select mono.

The left half of the dialog box defines what will be saved into the first section of a waveform file and the right half defines what will go into the second section of a stereo waveform. If the **File > Save As > Mono Waveform** option was selected, the right half of the dialog will be gray.

You can save the entire acquisition record or just the portion currently designated for transformation from either the channel A or channel B acquisition data. If the transform length is shorter than the acquisition record length, the waveform file will be correspondingly smaller.

Opening Acquired Waveforms

Figure 197. ATS Multitone Audio Analyzer **Open Stereo Waveform** dialog box.

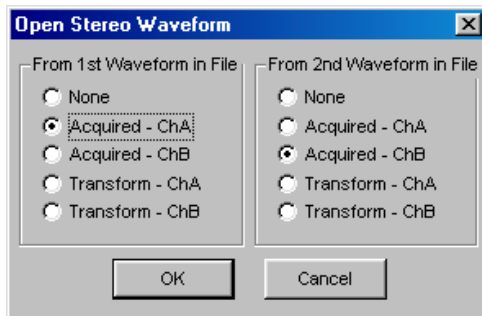

To open an acquired waveform file, select the **File > Open** menu command, choosing either the **Stereo Waveforms** (.aas) or **Mono Waveforms** (.aam) as the file type.

You can load one waveform or simultaneously load both waveforms into memory from a stereo file, and you can choose to assign the waveform to either channel and to the acquisition or the transform buffers. A mono file only contains one waveform, but you have the same flexibility to load it into either channel or either buffer. When opening a mono waveform file, the right half of the dialog box will be gray.

If acquisition in a file to be opened is greater than the length of the specified buffer, an error warning will be displayed and the file will not be opened. If the acquisition length in the file is shorter than the buffer size, erroneous analysis may result.

Combining Mono to Stereo

To compare two single-channel acquisitions made at different times or under different conditions, open the file containing the first acquisition data. Assign the waveform to channel A or B and load the data. Then open the second waveform file and do the same, this time loading the data into the opposite channel.

The resulting two-channel acquisition can be transformed, processed and viewed, and can be saved as a new stereo waveform file.

Compatibility of Acquired Waveform Files

The waveform files used by both the Spectrum Analyzer and the Multitone Audio Analyzer have the same format, and with certain restrictions on length, can be used by either instrument.

The Spectrum Analyzer has a larger acquisition buffer, and can open waveform files up to 256k samples in length. Multitone is limited to opening files with acquisitions of 32k or fewer samples.

Also, although any multitone waveform can be analyzed by the Spectrum Analyzer, only properly-formatted waveform files are useful in Multitone. See Chapter 11 for more information about the Spectrum Analyzer.

Creating Multitone Waveform Files

Many useful multitone waveforms are provided with ATS and can be found in the folder \ATS\Waveforms. You can also make your own custom multitone waveforms using the ATS-2 Multitone Creation utility. On the Main Menu, choose **Utilities > Multitone Creation**.

Multitone Creation Utility opening dialog box

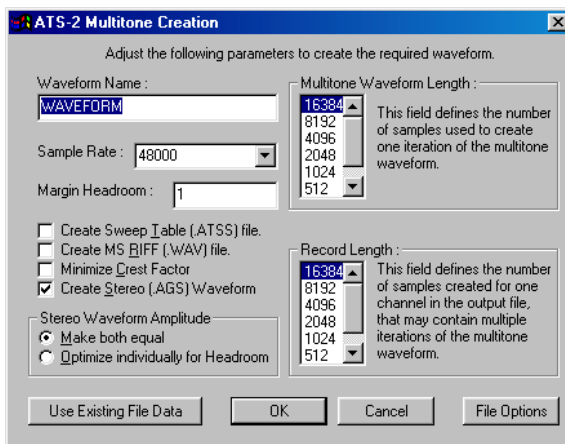

Figure 198. ATS-2 Multitone Creation Utility opening dialog box.

Figure 198 shows the opening dialog box for the Multitone Creation Utility. The key options are:

- **Waveform Name**

This is the filename you choose for your multitone waveform and for all the associated files created by the utility. The filename extension(s) will be chosen according to the file options you choose in other dialogs.

- **Sample Rate**

Set the sample rate of your multitone waveform to any rate between 28.8 kHz and 108 kHz, or set it to 131.072 kHz.

- **Margin Headroom**

Margin Headroom specifies in decibels the difference between the highest peak in the multitone waveform and digital full scale.

- **Multitone Waveform Length**

Choose from this list the length of one period of your multitone waveform. **8192** samples is a typical choice. The **Multitone**

Waveform Length cannot be longer than the **Record Length**, below.

■ **Record Length**

Choose from this list the total file length (for one channel, if a stereo waveform) for your multitone. **8192** is a typical choice. The file may contain multiple periods of the multitone waveform.

On the left of the panel are four checkboxes:

■ **Create Sweep Table File**

This option generates a sweep table file, with entries corresponding to each of the tones in the multitone file.

■ **Create MS_RIFF (.wav) File**

In addition to any Audio Precision generator waveform files, this option generates a Microsoft .wav sound file containing the same multitone waveform as the .agm or .ags source file.

■ **Minimize Crest Factor**

A complex waveform such as a multitone can have a high crest factor, making a low rms level necessary to prevent overload. Different phase relationships among the component tones can reduce the crest factor. The **Minimize Crest Factor** command enables an automatic feature which randomizes the phase relationships of the component tones repeatedly, then chooses the result with the lowest crest factor. In the small entry field to the right you can set the number of times to repeat the phase randomization before selection of the best candidate.

Since the phases of the tones are randomly changed during this process, the resulting multitone waveform will provide meaningful results only in interchannel (Ch.B–Ch.A) phase measurements.

■ **Create Stereo Waveform**

By default, the Multitone Creation Utility generates a mono Audio Precision generator waveform file, with the filename extension .agm. If this box is checked, a stereo waveform file is generated, with the filename extension .ags. When **Create Stereo Waveform** is checked, two option buttons appear below the checkbox:

- **Stereo Waveform Amplitude: Make both equal**

The A and B channels of a waveform, unless identical, will have different crest factors. This choice optimizes the level of the channel with the higher peak amplitude at the selected **Headroom** setting, then modifies the amplitude of the opposite channel by the same factor.

- **Stereo Waveform Amplitude: Optimize individually for Headroom**

This choice optimizes the peak level of each channel individually with respect to the Headroom setting. Since the channels will likely have different crest factors, the level of the fundamental tones in the two channels will likely be different after optimization.

At the bottom of the panel, there are four buttons:

- **Use existing file data**

This command begins the file creation process, using the data from a test or data file for tone frequency, level and phase settings. See **Use existing file data**, below.

- **OK**

Like **Use existing file data**, this command begins the file creation process, but uses the settings you make on the Frequencies Menu for tone frequency, level and phase settings. See **Frequencies Menu**, below.

- **Cancel**

This command exits the Multitone Creation Utility, making no changes in your current test or files on disk.

- **File options**

This command opens the Supporting File Creation Options dialog box. See below.

When you have made the settings you want from this panel, click **OK** to create a waveform from the Frequencies Panel, or **Use existing file data** to create a waveform from existing data.

As you initiate the file creation process (by clicking **OK** or **Use existing file data**), the Multitone Creation Utility will save your current ATS test as a temporary file named “Makewave.tmp”. This frees up the ATS workspace and memory buffers for file creation tasks.

When the Multitone Creation Utility is finished, the file Makewave.tmp is reloaded into ATS. If you want to do further work with this test, you should save it under its original filename or under a new filename of your choice.

Using Existing File Data

This command begins the file creation process by using the data in memory or in a data file for tone frequency, level and phase settings. To create a new list of frequencies in Multitone Creation Utility, click **OK** instead.

First the current test is saved as “Makewave.tmp”. Then you are presented with the following dialog box:

Choose **File > Open** from the ATS Main menu and select the test or data file which has the information you want in it, and then click **Con-**

Figure 199. ATS Multitone Open File dialog box.

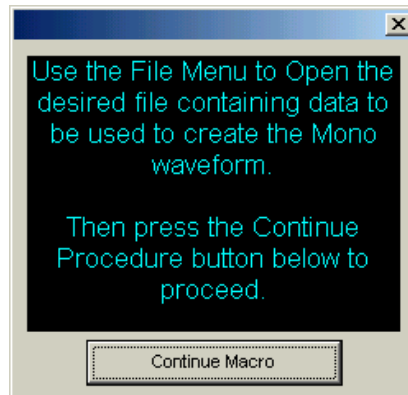

tinue Macro. Go to **Editing the Frequency list**, below.

File Options

Figure 200. ATS-2 Multitone Creation Utility Supporting File Creation Options dialog box.

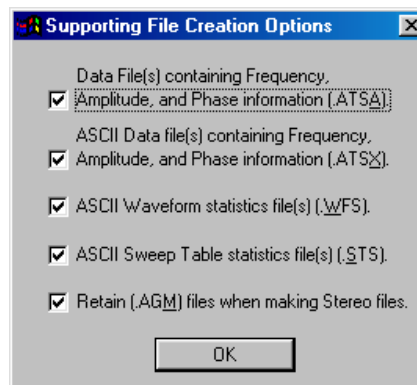

The File Options button opens the Supporting File Creation Options dialog box, which offers the following options:

- **Data File(s), containing Frequency, Amplitude and Phase Information (.atsa)**
In addition to the .agm or .ags generator files and sweep table files, this option specifies the creation of an Audio Precision data file.
- **ASCII Data file(s) containing Frequency, Amplitude and Phase Information (.atsx)**
This is an ASCII text file containing the same information as the data file in a text table.

- **ASCII Waveform statistics file(s) (.wfs)**
This is a text listing of statistics concerning the waveform files created.
- **ASCII Sweep Table statistics file(s) (.sts)**
This is a text listing of statistics concerning the sweep table file created.
- **Retain (.agm) files when making Stereo files**
When making a stereo generator waveform file, this option enables you to also generate two mono files, each containing the waveform information for one channel.

Frequencies Menu

Figure 201. ATS-2 Multitone Creation Utility
Frequencies Menu dialog box.

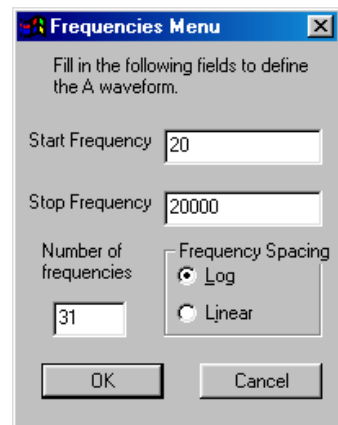

First, define the range of your multitone signal. Enter the lowest frequency in the **Start Frequency** field, and the highest in the **Stop Frequency** field. Select **Log** or **Linear Frequency Spacing**, and set the **Number of Frequencies** by entering a positive integer in the field.

Editing the Frequency List

Click **OK** when you have made your settings. The Multitone Creation Utility will open the Data Editor, displaying the frequencies you have defined, and also the Edit Waveform Definition Menu, as shown in Figure .

The first three buttons on the Edit Definition Menu affect all the frequency selections in the Data Editor.

- **Randomize Phase values**
To help minimize the waveform crest factor, this command randomizes phase values. This is the same as one iteration of the **Minimize Crest Factor** function.

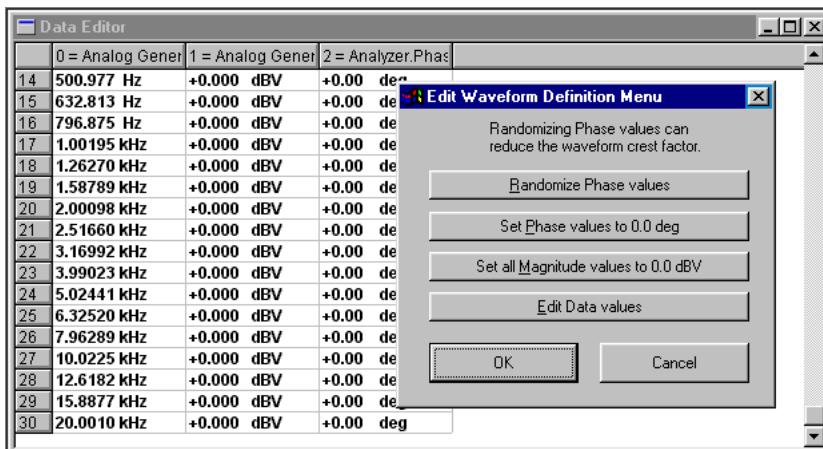

Figure 202. ATS-2 Multitone Creation Utility **Edit Waveform Definition Menu** dialog box.

- **Set Phase values to 0.0 deg**

This sets all phase values to 0.0 degrees.

- **Set all Magnitude values to 0.0 dBV**

This sets all tone amplitudes to 0.0 dBV.

- **Edit Data Values**

This command gives you access to the Data Editor, where you can edit the waveform data, adding or deleting rows, and changing frequencies, amplitudes and phase values.

If you add new frequencies using Edit Data Values, be sure that the frequencies you choose are synchronous. See Appendix C for a discussion of synchronous FFTs.

When you are done editing the data, click **OK**.

Sweep Table Definition

If you have requested a sweep table, a dialog box will open to enable you to define the frequencies listed in the sweep table. Your options are as follows:

- **Fundamental Frequencies**

This will list all of the fundamental frequencies in your waveform in the sweep table.

- **Harmonics**

If you select **Harmonics**, the Multitone Creation Utility will calculate the harmonics you specify for each of the fundamental tones, and will list these frequencies in the sweep table. You can specify the range of harmonics you desire and the utility will generate them up to

the Nyquist frequency. You can optionally select to only list the odd harmonics.

■ IM Products

If you select IM Products, the Multitone Creation Utility will calculate the intermodulation sum and difference products to the order you specify for each combination of fundamental tones, and will list these frequencies in the sweep table. You can specify a listing of **IM Products** up to the order you desire, and the utility will generate them up to the Nyquist frequency.

You must choose at least one of these selections for a valid sweep table definition. If you want only a subset of these frequencies, you can delete rows from the sweep table using the Data Editor or the Attached File Editor.

Creating an MS RIFF (.wav) File

If you have requested a .wav file, the following dialog box will open:

You can specify the length of the file, the resolution in bits, and the type of dither to be used. See page 120 for more information about dither.

Figure 203. ATS-2 Multitone Creation Utility MS RIFF Creation dialog box.

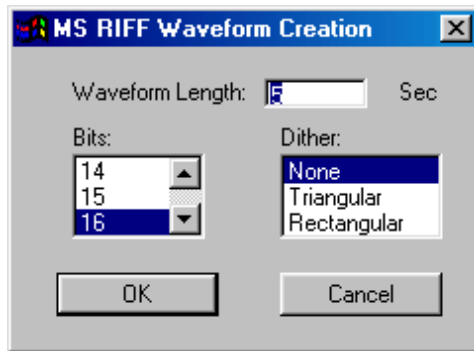

Final Options

A final series of dialog boxes will open, with some examples shown here.

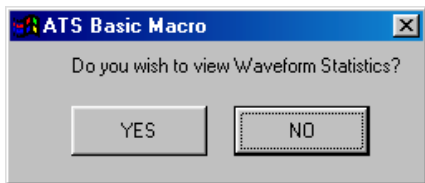
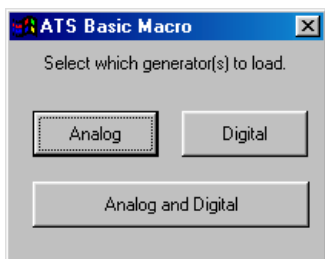
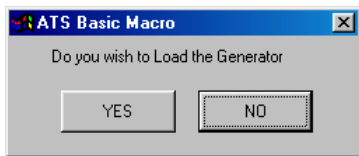

You may reply **Yes** or **No** to any of these boxes. At this point in the process, all the files you have requested have been created and saved, so replying **No** will not change or abort multitone creation. The **Yes** options enable you to continue directly with your testing or to immediately view the statistics files.

Chapter 14

The Harmonic Distortion Analyzer

Figure 204. The *Harmonic Distortion Analyzer* panel.



Introduction

The **Harmonic Distortion Analyzer** is a DSP instrument selection on the Analyzer panel. The **Harmonic Distortion Analyzer** permits flexible, highly selective measurement of the amplitude of user-specified harmonic orders. You can choose to measure any individual harmonic or the sum of any arbitrary selection of harmonic distortion products from the 2nd through the 15th.

The **Harmonic Distortion Analyzer** uses FFT techniques to isolate and measure each harmonic. The FFT bins are very narrow, and measure-

ment of residual noise is almost entirely excluded. This means that the **Harmonic Distortion Analyzer** can measure harmonic distortion without noise for any specified set of harmonic products. If all the harmonics are selected, the **Harmonic Sum** meters read THD (Total Harmonic Distortion) without noise.

Even though it is internally based on FFT technology, the **Harmonic Distortion Analyzer** effectively operates as a real-time program. The analyzer drives constantly-updating panel meters and its results can be displayed on bargraphs or plotted as traces on a graph. See Appendix C for more information on FFTs.

The **Harmonic Distortion Analyzer** will accept either digital or analog domain audio input signals, as selected by the **Input** field at the top of the panel. It is a two-channel instrument, capable of performing measurements on both channels of a stereo signal at the same time. For an analog signal, the **Harmonic Distortion Analyzer** can measure a frequency range from dc to half the converter sample rate ($F_s/2$). set on the Analog Input panel; for digital signals, the **Harmonic Distortion Analyzer** can measure a frequency range from dc to half the signal sample rate ($F_s/2$).

There are four pairs of meters on the **Harmonic Distortion Analyzer** which measure the input signal simultaneously:

- The **Fundamental Amplitude** meters.
These meters display the signal amplitude at the selected fundamental frequency. The frequency that the **Harmonic Distortion Analyzer** identifies as the fundamental is determined by the selection made in the Steering Control field, discussed below.
- The **Fundamental Frequency** meters.
These meters display the frequency of the highest-amplitude component of the applied signal. These frequency meters (or *counters*) are only enabled when **Counter Tuned** is selected in the Steering field.
- The **Harmonic Sum 1** meters.
These meters display the sum of the amplitudes of the harmonics selected in the **Harmonic Sum 1** fields, and
- The **Harmonic Sum 2** meters.
These meters display the sum of the amplitudes of the harmonics selected in the **Harmonic Sum 2** fields.

As on other ATS panels, you can select the units of measurement you prefer for each reading display.

The two Harmonic Sum readings will correctly sum and display only the distortion products which are within the bandwidth limitations determined by the sample rate. See page 249 for more information on bandwidth limitations.

Loading the Harmonic Distortion Analyzer

Figure 205. Loading the Harmonic Distortion Analyzer



To use the **Harmonic Distortion Analyzer**, first open the Analyzer panel by choosing **Panels > Analyzer** or by the keyboard shortcut **Ctrl+Y**, or by clicking the **Analyzer** button on the Toolbar.



Now select **Harmonic Distortion Analyzer** from the list on the Analyzer panel. This loads the Harmonic Distortion Analyzer program into DSP.

Signal Inputs

Figure 206. Harmonic Distortion Analyzer panel inputs.

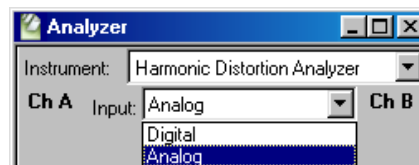

The **Input** field of the **Harmonic Distortion Analyzer** offers two signal input selections: **Digital** and **Analog**. These choices access the signals routed from the Digital Input/Output (DIO) panel or the Analog Input panel, respectively.

Digital signals are applied directly to the **Harmonic Distortion Analyzer** DSP; analog signals are first digitized by precision ADCs (selected on the Analog Input panel) before being applied to the **Harmonic Distortion Analyzer**.

To configure analog input connectors, range, coupling, select ADCs, bandwidth, etc., go to the Analog Input panel (see Chapter 6). To configure digital input connectors, digital input format and other aspects of the interface, go to the DIO panel (see Chapter 7).

The Fundamental Amplitude Meters

Figure 207. Harmonic Distortion Analyzer Fundamental Amplitude Meters.



Two Fundamental Amplitude meters are located near the top of the **Harmonic Distortion Analyzer** panel, one for each input channel.

The **Fundamental Amplitude** meters display the rms value of the input signal component at the frequency defined by the **Steering** control (described on page 251). This is typically the stimulus signal frequency, generated by ATS-2's analog or digital generator. This amplitude value is used as the reference for all ratio units (% , dB, ppm, X/Y) when the **Ratio** box is checked for any **Harmonic Sum** meter.

The Fundamental Frequency Meters

Immediately below the **Fundamental Amplitude** meters are the **Fundamental Frequency** meters (or *counters*) for the two channels. These display the frequency of the dominant component of the input signal, normally the fundamental signal. This is the frequency that the **Harmonic Distortion Analyzer's** selective analysis capability will track when **Counter Tuned** is selected for the Steering mechanism.

The Frequency meters are only enabled when **Counter Tuned** is selected.

Harmonic Distortion Product Amplitude

Figure 208. Harmonic Distortion Analyzer Product Amplitude Meters.

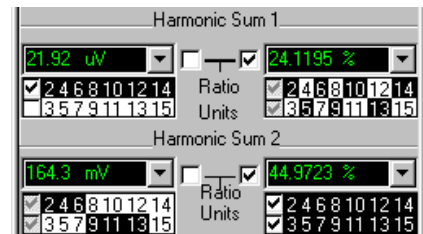

Below the **Frequency** meter displays are panel sections labeled **Harmonic Sum 1** and **Harmonic Sum 2**. Each section contains a meter display and control fields for input channels A and B, for a total of four **Harmonic Sum** meters. Each meter consists of the digital display, a **Ratio** unit checkbox, and controls for selecting the harmonic orders that the

meter will measure. The meter display has the usual ATS selections of amplitude units. When the **Ratio** units box is checked, the meter will display in units of %, **dB**, **X/Y**, or **ppm**, referenced to the fundamental amplitude.

Harmonic Order Control

The rows of numbers below each Harmonic Sum meter provide the means to select the harmonics the meter reads.

The upper row of numbers selects the even harmonic orders through the fourteenth—2, 4, 6, 8, 10, 12, and 14. The lower row selects the odd harmonic orders through the fifteenth—3, 5, 7, 9, 11, 13, and 15. You can select or deselect any harmonic order by clicking on the number of the order. Clicking the checkbox at the beginning of a row selects or deselects the entire row of harmonic orders.

When only one harmonic order has been selected for a particular meter, the display in the meter is the amplitude of the specific harmonic signal selected. For example, clicking **3** in the lower row causes the associated display to continuously measure the amplitude of the third harmonic only.

Clicking the **2**, **8**, and **10** in the upper row and the **7** and **13** in the lower row of a meter causes a continuous display of the rms sum of the 2nd, 7th, 8th, 10th, and 13th harmonics of the signal. Checking the boxes at the left end of both rows causes a THD (total harmonic distortion, without noise) measurement that includes the effects of the 2nd through the 15th harmonics.

Distortion Product Bandwidth Limitations

Note that only those harmonic components within the measurement bandwidth of the analyzer can be measured, even if all the harmonic orders are selected.

For example, assume that an analog signal is being measured using the **HiRes@65536** converter selected on the Analog Input panel, which establishes a bandwidth to about 30 kHz.

If the fundamental frequency is 9 kHz, only the 2nd (18 kHz) and 3rd (27 kHz) harmonics fall within the measurement bandwidth. Selecting any harmonic orders above the 3rd will have no effect on the measurement. When the fundamental is below about 2 kHz, all harmonics up to and including the 15th will be measured. When the stimulus signal frequency is swept during a test, higher-order harmonics will be included while the stimulus frequency is low but excluded by the fixed bandwidth when the stimulus frequency is high.

With analog signals, measurement bandwidth may be increased to as high as approximately 120 kHz with the **HiBW@262144** selection, if the optional high-bandwidth converter is installed in ATS-2.

With digital signals, bandwidth is intrinsically determined by the sample rate of the device or system being measured.

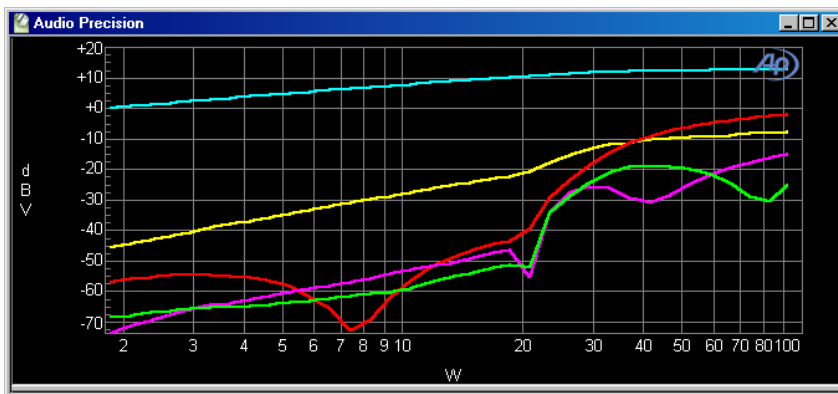

Figure 209. Fundamental (top curve), 2nd harmonic, 3rd harmonic, 4th harmonic, and 5th harmonic amplitudes of a loudspeaker as a function of power.

The four **Harmonic Sum** meters are completely independent from one another. On a given channel, one may be set for even harmonics and the other for odd harmonics; or, one may measure a single individual harmonic while the other measures an arbitrary group of harmonics that may or may not include the single harmonic selected on the other meter. Each **Harmonic Sum** reading for each channel may be simultaneously plotted as a separate trace on the graph during a single sweep.

Amplitude Units

If you click on the arrow to the right of any amplitude or **Harmonic Sum** meter reading field, a list of measurement unit choices will drop down. The units shown on the list depend upon whether **Analog** or **Digital** is selected in the Input field.

With **Digital** selected, the units list displays:

- digital domain units: **FFS**, **dBFS**, **%FS** and **Bits**;
- relative units: **dBr A** and **dBr B**; and
- units relative to the analog domain: **V**, **dBu**, and **dBV**.

These analog domain units are calculated using the value you enter in the **V/FS** field in the References area of the panel, and can be helpful in cross-domain measurements.

With **Analog** selected, the units list displays:

- analog domain units: **V**, **dBu**, **dBV**, and **W** (watts).
- relative units: **dBr A**, **dBr B**, **dBg A**, **dBg B**;
- and units relative to the digital domain: **FFS**, **dBFS** and **%FS**.

For an explanation of the units of measurement used in ATS and the references for the relative units, see Appendix A, **Units of Measurement**.

Click the Ratio checkbox of any of the Harmonic Sum meters to select the ratio units **%**, **dB**, **X/Y**, and **ppm** for that meter. The reference of these ratio units is the Fundamental signal amplitude of that channel.

References

Analog and digital amplitude and frequency references for the Harmonic Distortion Analyzer are the same as for other Analyzer instruments. See **Analyzer Analog References** on page 151 and **Analyzer Digital References** on page 152.

Steering Control

Figure 210. The Harmonic Distortion Analyzer Steering control field.



The Harmonic Distortion Analyzer must identify the fundamental frequency that you have selected for your measurement. The amplitude of the fundamental component is used as the basis of the Ratio measurements, and the precise frequency of the fundamental must be known to calculate the frequencies of each of the harmonics to be measured.

The Steering control determines how the **Harmonic Distortion Analyzer** identifies the fundamental signal component. The Steering control field is centered just above the References section on the **Harmonic Distortion Analyzer**.

The Steering control enables you to choose a source of frequency “steering” for the identification of the fundamental frequency. The five selections available in this field are:

■ Counter Tuned

Counter Tuned uses the measured frequency value displayed in the Fundamental Frequency field as the steering source for the fundamental and harmonic selectivity. Choose this mode when making harmonic distortion measurements from an external signal such as playback of a Compact Disc or audio tape, or the received signal from a distant source.

■ Sweep Track

With **Sweep Track** selected, the fundamental frequency value tracks the frequency of whichever generator is selected in the **Source 1** or **Source 2** fields of the Sweep panel.

■ AGen Track

With **AGen Track** selected, the fundamental frequency will automatically track the frequency of the Analog Generator.

■ DGen Track

With **DGen Track** selected, the fundamental frequency will automatically track the frequency of the Digital Generator.

■ Fixed

Fixed sets the fundamental frequency to the value you enter in the field to the right.

High Speed/High Accuracy Control

Figure 211. Harmonic Distortion Analyzer Distortion High Speed / High Accuracy selection.



The **Harmonic Distortion Analyzer** is normally configured to provide accurate results quickly.

When making measurements of distortion products which are lower than -90 dB or -100 dB (lower than 0.003% to 0.001%) relative to the fundamental, you can choose to set the instrument to a mode of even higher accuracy, at the price of some sweep speed.

In the field to the left of the Steering control, choose **High Accuracy** to enable this mode. The default mode is **High Speed**.

THD vs THD+N

Measurements of THD+N (total harmonic distortion plus noise) vs. THD (total harmonic distortion, not including the effects of noise) on the same signal may differ for two reasons—one theoretical, and the other due to the architecture of typical THD+N analyzers.

The theoretical difference between THD and THD+N lies in the “+N” term—the noise. If distortion products are much higher in amplitude than the wide-band noise in a signal, the two techniques should give essentially identical results. In many cases with modern, well-designed audio equipment, actual distortion is very low across most of the normal operating dynamic range and wide-band noise dominates.

A THD+N analyzer operates by removing the fundamental signal with a notch (bandreject) filter, then measuring everything left over. The left-over signal, in this case, is the wide-band noise and distortion products.

A THD analyzer makes highly selective amplitude measurements only at each specific harmonic product frequency. The bandwidth of these selective measurements is so narrow that noise has almost no effect. In such a noise-limited case, a THD analyzer (such as Harmonic Distortion Analyzer) may produce a much lower value than a THD+N analyzer (such as the Audio Analyzer in THD+N functions).

Another difference comes about only when Ratio units (% , dB, X/Y, or ppm) are selected. Practical THD+N instruments make a compromise with the actual definition of distortion ratios in the interest of circuit economy. The definition of THD and THD+N ratios computes the amplitude of the distortion or distortion and noise products with reference to the amplitude of the fundamental signal component. However, practical THD+N analyzers use the amplitude of the input signal, including all distortion products, as the reference instead of the fundamental component alone. At total distortion values of 10.0% and lower (–20 dB and below), the difference between these two approaches is negligible. At higher distortion values, the difference may become large.

For example, when the distortion products are at 10.0%, the difference in amplitude between the fundamental component and the complex signal including distortion is less than 0.5%, so distortion values stated as a percentage of either value are nearly the same. At 45%, typical of a squarewave, there is about a 9.6% difference between stating distortion ratios relative to the fundamental rather than to the entire, distorted input signal.

The ATS-2 Harmonic Distortion Analyzer makes a selective amplitude measurement of the fundamental signal and refers all Ratio units to that value, conforming to definitions. The ATS-2 Audio Analyzer in the THD+N Ratio function, like all other commercially available THD+N analyzers, refers the distortion product measurements to the raw input signal that includes fundamental and harmonics.

Sweeping and Graphing Results

The fundamental and the harmonic products measured by the **Harmonic Distortion Analyzer** can be swept and graphed in ATS.

The **Harmonic Distortion Analyzer** must be selected as the Analyzer instrument. Choose **Harmonic** as the instrument in the Sweep **Data** or **Source** browser, and the following **Parameter** selections will be available for sweeps:

- ChA Fund Ampl
- ChA Fund Freq
- ChA Harm Sum1
- ChA Harm Sum2
- ChB Fund Ampl
- ChB Fund Freq
- ChB Harm Sum1
- ChB Harm Sum2

Chapter 15

Sweeps and Sweep Settling

Introduction: Sweeps and Graphs

A “sweep” is a measurement which includes a number of points of data, the result of varying or “sweeping” one (or more) test parameters across a certain range and reporting the value of other test parameters at regular points during the sweep.

You can force ATS to perform a “single-point sweep” for special purposes, but generally the term sweep indicates that a number of data points are included in the measurement.

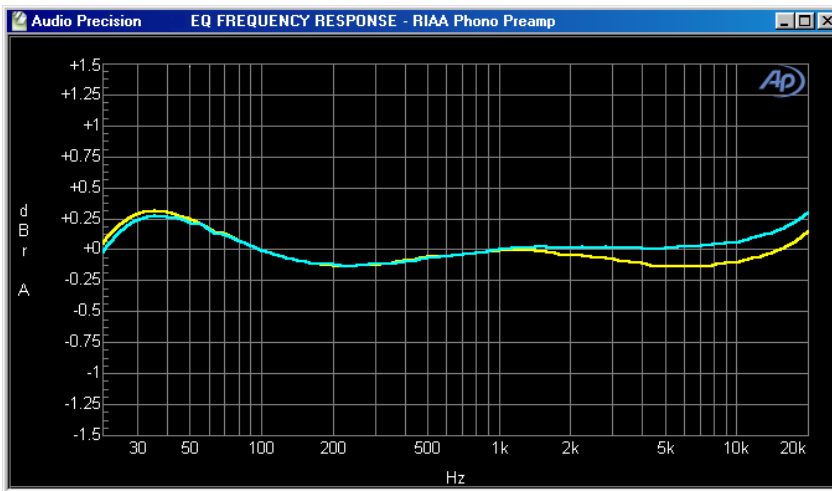

Figure 212. Graphical display of sweep results.

The results of a sweep can be listed in a table and viewed in the Data Editor; more commonly, the results are plotted on a Graph. As you will

see, ATS's Sweep, Data Editor and Graph functions are closely tied. When the Data Editor and the Graph panel are open next to your Sweep panel, you can watch the data values and the graph coordinates and traces respond to your Sweep panel settings. See **Sweep Display Mode**, page 265; **Graphs**, page 285, and **Editing Data and Setting Limits**, page 307.

Many times aspects of sweep functions can be described in graphic terms; for example, the **Source** divisions are called "X-axis divisions;" **Data** results are often called "traces" and so on.

The ATS Sweep function gives you the following capabilities:

- You can sweep a parameter as an independent variable across a range you define. This can be an ATS instrument parameter, set in **Source 1**, a table of pre-defined values, an external signal tracked as a sweep source, or a time base to generate chart-recorder type plots.
- As many as six other parameters (called **Data 1** through **Data 6**) can be measured during the sweep.
- You can choose from extensive lists of settings or readings for either **Source** or **Data** selections.
- You can set the number of sweep steps (or the distance between the steps) made within your range.
- You can impose pass / fail limits on your results.
- You can specify the units and divisions displayed on your graph.
- You can set sweeps to automatically repeat.
- You can append successive sweeps on your graph.
- You can nest sweeps to generate curve families.

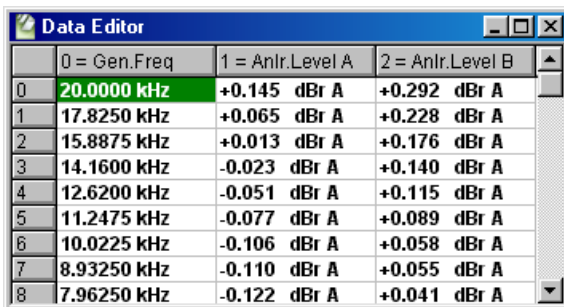

	0 = Gen.Freq	1 = Anlr.Level A	2 = Anlr.Level B
0	20.0000 kHz	+0.145 dBm A	+0.292 dBm A
1	17.8250 kHz	+0.065 dBm A	+0.228 dBm A
2	15.8875 kHz	+0.013 dBm A	+0.176 dBm A
3	14.1600 kHz	-0.023 dBm A	+0.140 dBm A
4	12.6200 kHz	-0.051 dBm A	+0.115 dBm A
5	11.2475 kHz	-0.077 dBm A	+0.089 dBm A
6	10.0225 kHz	-0.106 dBm A	+0.058 dBm A
7	8.93250 kHz	-0.110 dBm A	+0.055 dBm A
8	7.96250 kHz	-0.122 dBm A	+0.041 dBm A

Figure 213. Tabular display of sweep results graphed in Figure 212.

Batch Mode "Sweeps"

The ATS Sweep panel is also used to initiate and display batch mode DSP measurements. Although these are unlike real-time sweeps in that there is not a swept generator signal or discrete channels of resultant data to be graphed, batch-mode measurements are similar from an operational point of view and in the graphical requirements for an X-Y type plot with scaled and calibrated axes.

Batch mode sweeps are selected by choosing the Spectrum Analyzer, the Digital Interface Analyzer or the Multitone Audio Analyzer in the Sweep **Source** and **Data** instrument browsers.

This chapter focuses on real-time sweeps. For setup and operation of the Sweep panel in batch mode measurements, see the material in **The Spectrum Analyzer**, Chapter 11; **The Digital Interface Analyzer**, Chapter 12; and **The Multitone Audio Analyzer**, Chapter 13.

*There are a few Sweep controls (**Transform Data w/o Acquire, Reprocess Data** and **Spectrum<=>Waveform**) which affect only batch mode measurements. The operation of these controls is briefly mentioned in this chapter and explained in more detail in the specific Analyzer chapters.*

Plan Your Sweep

When you begin a sweep, a list of questions like these can help you develop an effective test strategy:

- What parameter will the test sweep? In other words, what is the independent variable?
- Over what range?
- What data results do I want to see? That is, what will the dependent variables be?
- What range do I expect the results to cover?
- How many points of data do I need?
- How close together must they be?
- Would my sweep be more useful on a linear or a logarithmic scale?

With this type of information at hand it will be easy to set up the Sweep panel for your test. We'll start by looking at the ATS Sweep panel and its controls and displays.

The Sweep Panel

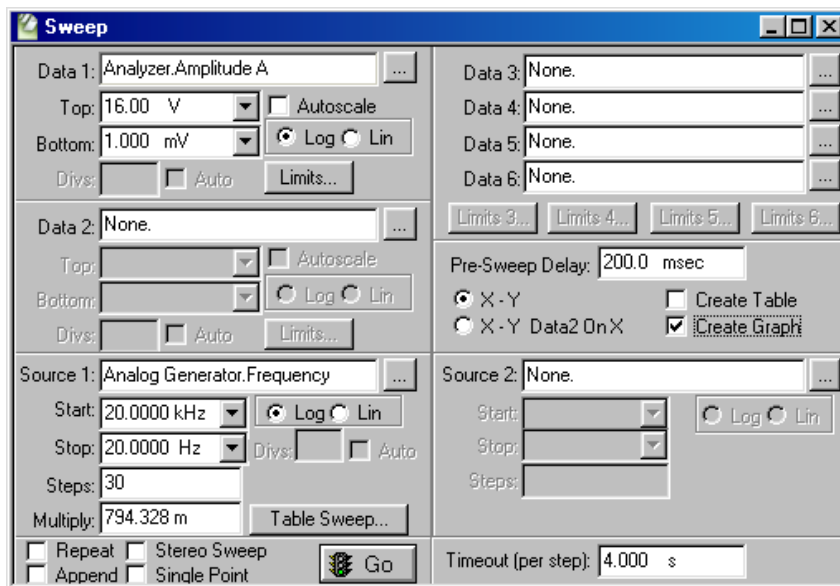

Figure 214. The ATS-2 Sweep Panel (expanded display).



The ATS Sweep panel is available by selecting **Panels > Sweep** from the Menu bar or by clicking the **Sweep** button on the toolbar; you can also launch the Sweep panel by selecting **Sweep > Show Panel** from the Menu bar or by using the keyboard combination **CTRL+S**.

Normally, the Sweep panel is used to control a Generator and to collect readings from the Analyzer to produce sweeps for graphing. It also sets the parameters for External Sweeps, and sets the parameters to control FFT graphing for batch-mode instruments.

The compact display of the ATS Sweep panel (which is the left half of the panel shown in Figure 214) allows you to set up a single-**Source** sweep with one or two sets of **Data** results. If you expand the panel as shown above, you can use two sweep **Sources** and up to four more **Data** result traces, and you have access to additional controls and settings on the Sweep panel.

Source 1

Every sweep must have at least one sweep **Source** and one set of **Data** results. The **Source 1** area on the Sweep panel is where you will select and define your primary swept parameter, the independent variable deliberately changed during a sweep test. In a graph of a sweep, **Source 1** usu-

ally defines the X-axis (the horizontal graph axis). **Source 2** is used for nested sweeps, which are discussed on page 269.

Settings or Readings?

Source 1 will typically be an internal ATS setting, such as Analog Generator frequency or amplitude. It could just as well be a Digital Generator setting, or a Digital I/O setting such as **Output Sample Rate**, for example.

It is also possible to use an external signal as the swept parameter (the independent variable). In this case **Source 1** is set to an ATS reading such as Audio Analyzer frequency or amplitude. A sweep which uses readings for a source is called an External Sweep. External Sweeps are discussed beginning on page 263.

Selecting a Sweep Source

When ATS is first loaded, the default sweep source in **Source 1** is the Analog Generator frequency. To select a different source, click on the **Source 1** browser button.

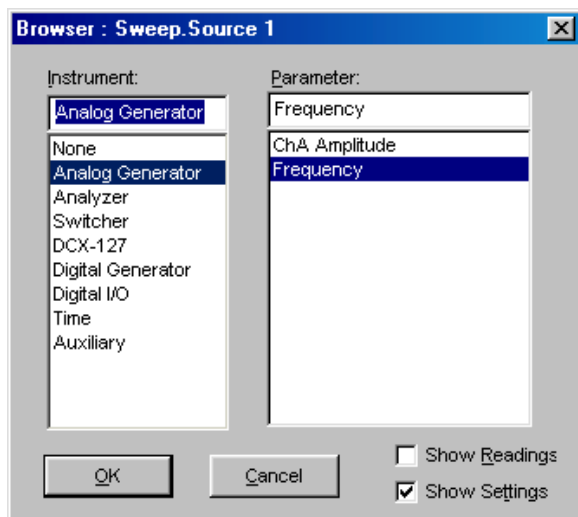

Figure 215. The Sweep **Source 1** browser dialog box.

A dialog box will open that displays the instruments and parameters available as sweep sources. Click on a instrument and you will see the settings associated with it in the right browser window.

For ordinary sweeps be sure that you have selected your source from the instrument settings list. Instrument readings are used for External Sweeps, page 263. The check boxes on the browser allow you to choose the settings or readings lists.

Start and Stop Values

The values entered in the **Source 1 Start** and **Stop** fields set the sweep range and direction, and also become values for the graph X-axis end points.

In a frequency sweep, for example, the default settings are 20 kHz in the **Start** field and 20 Hz in the **Stop** field.

With these settings, the sweep will move downward in frequency from 20 kHz to 20 Hz. If you would like your sweep to move upward from low to high, enter 20 Hz as the **Start** value and 20 kHz as the **Stop** value.

Source 1 Log or Lin Scales

If neither the **Start** nor the **Stop** value is zero or negative, you have the option of calibrating the **Source 1** axis with a logarithmic or a linear scale. Click on the **Log** or **Lin** option buttons to change the scale.

If either value is zero or negative, or if decibel units are chosen (these are available for an amplitude source), the **Log** and **Lin** option buttons will not be available and the scale will be set to linear.

The choice of scale affects the way that step size is calculated for the sweep and also the distribution of the vertical divisions on the resultant graph.

Sweep Resolution

The range between the **Start** and **Stop** values will be stepped through as follows:

- in equal-size increments, in **Lin** scale mode, or
- in equal-percentage increments, in **Log** scale mode.

The number of steps, the size of each step, the **Log / Lin** selection and the range between the **Start** and **Stop** values are all interrelated.

Linear Scale Steps

When using a linear scale, you can set the step size by entering the number of steps in the **Steps** field. Only integers between 1 and 65,000 are accepted. After you have made an entry, the value in **Stepsize** will be

recalculated. Alternatively, you can enter a value in the **Stepsize** field and ATS will calculate the correct number of steps to produce this step size.

If the value you enter does not result in an integer number of steps, ATS will round the calculated value of steps to the next lower integer value to maintain the exact step size you have entered. ATS then takes care of the remainder by adding a final, smaller step to the **Stop** value.

Logarithmic Scale Steps

When using a logarithmic scale, the field which had been called **Stepsize** in Lin mode is renamed **Multiply**. You can set the step size by entering the number of steps in the **Steps** field just like the **Lin** setting. Or, you can enter a value in the **Multiply** field and ATS will calculate the correct number of steps to produce this step-to-step multiplier.

If the value you enter does not result in an integer number of steps, ATS will round the calculated value of steps to the next lower integer value to maintain the exact step-to-step multiplier you have entered, and then takes care of the remainder by adding a final, smaller step to the **Stop** value.

X-Axis Divisions

In **Lin** mode if **Auto** is checked, the grid lines are selected automatically based on the **Source 1** settings. If **Auto** is not checked, you can specify a number of grid lines by entering a value into the **Div** field.

In **Log** mode, the placement of grid lines for the graph X-axis divisions is pre-determined and the **Div** field and the **Auto** checkbox are not available.

Data 1

As mentioned before, every sweep must have at least one sweep **Source** and one set of **Data** results. The **Data 1** area on the Sweep panel is where you select and define your primary data result, the dependent variable which changes in response to **Source 1**. In graphing a sweep, **Data 1** is shown as a trace or curve whose values are always read on the graph left Y-axis. A discussion of **Data 2** begins on page 263, and **Data 3** through **Data 6** are discussed on page 264.

Selecting the Data 1 Reading

The default reading for **Data 1** is the **Analyzer Level A** amplitude. To select a different reading, click on the **Data 1** browser button.

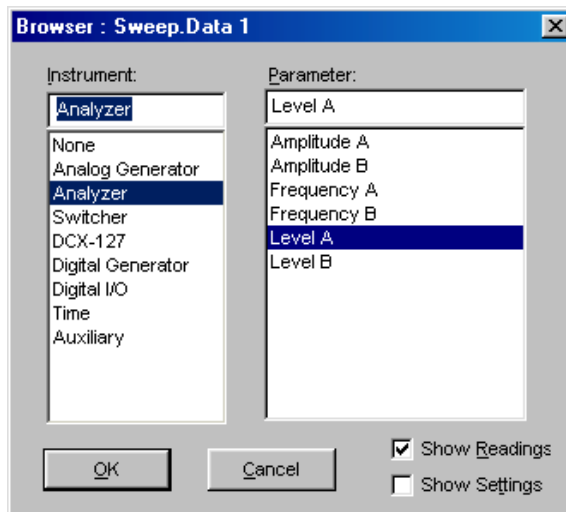

Figure 216. The Sweep **Data 1** browser dialog box.

A dialog box will open which displays the instruments and parameters available as data readings. Click on a instrument and you will see the readings associated with it in the right browser window.

Top and Bottom Values

Enter the graph top and bottom values in the **Top** and **Bottom** fields in the **Data 1** section of the Sweep panel. Drop the arrow list to change units of measurement.

Since **Data 1** displays the results of measurements, it is not always possible to predict the range of the values. If you set the **Top** or **Bottom** values too low or high, the data will still be acquired and saved, but the graph trace will not extend beyond the set values. In this case you can re-enter the **Top** or **Bottom** values and the graph will re-draw itself to correctly plot your results.

*You can also use the **Optimize** function on the Graph panel to reset the Y-axis extents to accommodate your results.*

You can also have ATS automatically set the **Top** and **Bottom** values on this panel in response to the **Data 1** readings. Click the **Autoscale** checkbox to enable this function.

Data 1 Log or Lin Scales

If neither the **Top** nor the **Bottom** value is zero or negative, you have the option of calibrating the **Data 1** axis on a logarithmic or a linear scale.

If either value is zero or negative, or if decibel units are chosen (these are available for amplitude data), the **Log** and **Lin** option buttons will not be available and the scale will be set to linear.

Y-Axis Divisions

In **Lin** mode if **Auto** is checked, the grid lines are selected automatically based on the **Data 1** settings. If **Auto** is not checked, you can specify a number of grid lines by entering a value into the **Div** field.

In **Log** mode, the placement of grid lines for the graph Y-axis divisions is pre-determined and the **Div** field and the **Auto** checkbox are not available.

These controls affect scaling for real-time data acquisition. The graph can be rescaled to accommodate the data in the graph buffer memory using the graph **Optimize** function, page 288.

Data Limits

The **Limits** button opens a dialog box enabling you to attach acceptance (pass / fail) limits to a test. See **Setting Limits**, page 310.

Data 2

Data 2 enables you to plot a second trace of data on your graph against its *own scale and calibration*, on the *right-hand* graph axis.

Data 2 operates in exactly the same way as **Data 1**, with these exceptions:

- **Data 2** plots against the scale on the graph right Y-axis, or, if the **X-Y Data2 on X** option button is selected,
- **Data 2** determines the X-axis calibration to enable you to plot two measured values, or readings, as an X-versus-Y graph. See below for an explanation of plotting data X-Y.

When **Data 1** and **Data 2** are plotted together on a graph, the **Data 1 Top** and **Bottom** range settings and intermediate values are displayed on the graph left Y-axis. The **Data 2 Top** and **Bottom** range settings and intermediate values are displayed on the graph right Y-axis.

Plotting Data as X-versus-Y

Sometimes it is useful to plot two measured values against one another under stimulus from a third signal.

In a Data X-versus-Y graph, **Data 1** is still plotted on the left Y-axis. **Source 1** is still the independent variable, stepping through the **Start / Stop** range and driving the test to create the changes in the **Data 1** and **Data 2** dependent variables which will be plotted. However, **Source 1** values and calibration will not be displayed on the graph at all; instead, **Data 2** values are used to calibrate the X-axis.

As an example, you can perform an amplitude sweep (**Source 1**) on a power amplifier and plot the measured percent distortion (**Data 1** on the Y-axis) against the measured power output (**Data 2** on the X-axis). The amplitude sweep itself is never displayed as such; however, the two sets of results are graphed to show their dynamic relationship.

You can switch between the conventional **X-Y** mode and the **X-Y Data2 on X** mode at any time using the option buttons on the expanded Sweep panel.

Limits cannot be graphed, and data cannot be compared to limits when the graph is in X-Y Data2 on X mode.

Data 3 through Data 6

*If you are viewing the Sweep panel in its compact mode and one or more of the **Data 3** through **Data 6** functions are in use, these will be listed in the Sweep panel title bar between sets of arrows, as shown below.*

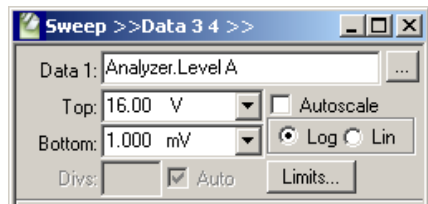

Figure 217. Compact View of the Sweep Panel with Data 3 and Data 4 active.

Data 3 through **Data 6** enable you to plot up to six variables when used with **Data 1** and **Data 2**. These additional **Data** functions operate in exactly the same way as **Data 1** and **Data 2**, with this exception: to be plotted on the graph, they must share a graph calibration scale (the horizontal scaling lines and the corresponding numerical legend displayed on the left or right Y-axes) with either **Data 1** or **Data 2**. Consequently, the **Data 3** through **Data 6** sections of the Sweep panel have no **Top** and **Bottom** or scaling fields.

To share a calibration scale with **Data 1** or **Data 2**, the measurements must be of the same “measurement domain.” For example, **dBV**, **dBm**, **V** and **W** are all of the same measurement domain, all being based on voltage measurements. Phase measurements or digital data measurements are not of this measurement domain and cannot be plotted against the same calibration scale as voltage.

Of course, all data in a sweep is always available in the Data Editor and can be viewed in a tabular form, regardless of measurement domain. Data that cannot be plotted due to measurement domain conflicts will be displayed in the Data Editor in the base unit for that measurement domain.

Here’s an example: if **Data 1** is percent distortion and **Data 2** is level, it will not be possible to also plot phase on **Data 3**. If, however, you wanted to plot channel A and B level and the phase difference between them, you could assign channel A level to **Data 1**, phase to **Data 2** and channel B level to **Data 3**. The **Data 3** measurements would be plotted against the left-hand Y-axis calibration set in **Data 1**.

Sweep Display Mode

When ATS makes a sweep, the results can be displayed as a graph, as a table, or both.

Click the **Create Graph** and / or **Create Table** checkboxes on the expanded Sweep panel to choose the sweep display mode. When you run a sweep you will be able to view the data entering your display in real time.

The tabular display is shown in the ATS Data Editor panel (see page 307). If you have made a sweep without **Create Table** set, you can still choose to view the data in the Data Editor, which is opened by clicking the **Data Editor** button or by using the Menu command **Panel > Data Editor**.



When using a graph for display, you are limited to two sets of unit choices (Volts, dBm, etc.) for your data results, since ATS can use only the left and right Y-axes to calibrate data values. However, in tabular form this constraint does not exist, and you can specify different units and measurement domains for each of the **Data 1** through **Data 6** columns, if you wish.

If you are running sweeps in an automated or manufacturing test situation where speed is most important, you can set both sweep display modes OFF for fastest performance.

Go / Stop / Pause

Once you have your **Source** and **Data** settings made, all that remains is to start the sweep. Simply click the **Go** button on the Sweep panel or the toolbar; you can also start the sweep by selecting **Sweep > Start** from the Menu bar or by pressing function key **F9**.

To stop the sweep, click the **Stop** button on the Sweep panel or the toolbar; you can also stop the sweep by selecting **Sweep > Stop** from the Menu bar or by pressing the **ESC** key.

To pause or unpause a sweep, press function key **F10**.

Repeat

You can set ATS to repeat your sweep indefinitely. Click the **Repeat** check box on the Sweep panel to enter the **Repeat** mode.

Selecting **Sweep > Start with Repeat** from the Menu bar or pressing the key combination **ALT+F9** sets the **Repeat** mode and starts the sweep.

When you need to interrupt repeated batch-mode processing such as FFT or multitone tests, do it by unchecking the **Repeat** box and letting the sweep completely finish. If you use **Stop** you will leave invalid data in the DSP that will result in a meaningless graph.

Append

You can set ATS to append your sweeps to the graph, retaining your previous data and appending the new data to the old. Normally, when not using **Append**, ATS clears the existing sweep data from the graph and from memory before beginning a new sweep.

To enter the **Append** mode, click the checkbox on the Sweep panel. Click the box a second time to remove the check and exit the **Append** mode.

Selecting **Sweep > Start with Append** from the Menu bar or pressing the key combination **CTRL+F9** sets the **Append** mode and starts the sweep.

Appending a File

You can also append previously saved data to a current sweep by using the **File > Append** command, which opens a file browser dialog box. Select a test (.ats2) or data (.atsa, .atsq, .atss or .atsl) file to be appended.

The data currently in memory and the file to be appended must be compatible in these ways:

- they must have compatible **Source 1** selections; for example, both set to frequency or both to amplitude.
- they must both have the same structure of **Data 1** and **Data 2** selections; for example, a data file with data plotted at both **Data 1** and **Data 2** can not be appended to current data in memory which has **Data 2** set to **None**.
- they must both have compatible “measurement domains;” for example, a measurement of distortion shown in percent units, which expresses a ratio, may not be appended to a measurement of level in amplitude units, which does not express a ratio. However, distortion shown in absolute units, such as volts or dBu, can be appended to amplitude data.

Data appended from a file will be graphed in the same color used in the original test or data file. Both the original and the appended data can be viewed in the Data Editor.

Stereo Sweeps

ATS has the ability to sweep two channels of a device simultaneously with the **Stereo** sweep function. Although you could manually set up two sweep **Data** functions and get the same results, using the **Stereo** sweep function brings some additional advantages.

- Automatic selection and setup of opposite channel data settings, including **Limit** file selection.
If you have entered a channel of only one reading instrument (in **Data 1**), ATS will set up the opposite channel in **Data 3** to match. Since both of these readings are of the same measurement domain, they will both be plotted against the calibration and scaling on the left-hand Y-axis. This leaves **Data 2** and the right-hand Y-axis available for other use.
If you also set up a channel from a second reading source (in **Data 2**) during a stereo sweep, ATS will automatically set up the opposite channel in **Data 4** to match.
- In stereo sweep crosstalk tests, ATS performs automatic input and output switching and runs two cross-channel measurements in succession. The two passes are plotted as separate data in one graph and saved in one file.

To make a **Stereo** sweep:

- Set up **Source 1** and **Data 1** (and **Data 2**, if you want to plot two different pairs of variables) for your sweep.
- Click the **Stereo** checkbox on the Sweep panel.

Some reading parameter selections (such as **Phase** or **DCX-127 DMM Volts**) are not stereo signals. If you select such a parameter for **Data 1** or **Data 2**, the **Stereo** sweep function will not be available.

Opposite-channel **Limit** files which have been automatically attached to **Data 3** or **Data 4** in Stereo sweep can be changed or disabled by clicking the **Limits** button for that **Data** function.

Single Point Sweeps

A single point sweep is an ATS sweep in which the independent variable, **Source 1**, is held at only one value. ATS can then acquire the measurement data for any dependent variables you have set in **Data 1** through **Data 6**.

Single point sweeps are often used in AP Basic macros to “grab” a value or set of values. Single point sweep results differ from meter readings in several ways:

- The single point **Data** result is dependent upon the **Source** value specified.
- The data can be displayed in a tabular format in the Data Editor.
- The data can be saved as an .atsa file, and recalled or exported.
- Sweep settling algorithms and delays can be applied.
- The data results can be compared against **Limit** files.

To make a single point sweep, click the **Single Point** checkbox on the Sweep panel. Then select an instrument setting parameter for **Source 1**. Enter the value at which you want to make your measurement in the **Source 1 Start** field, and set up whatever **Data** functions you want.

Since an X-Y graph cannot be drawn for a single point measurement, the result will only be displayed in a table. Select **Create Table** on the expanded Sweep panel. Click **Go**, and data will be acquired and displayed in the Data Editor table. See **Sweep Display Mode** on page 265 and **Data Editor** on page 307.

Nested Sweeps using Source 2

ATS can generate a family of curves using **Source 1** and **Source 2** together in a *nested sweep*. An ATS nested sweep controls two different setting parameters in an interrelated manner.

You can use nested sweeps to generate a set of frequency response curves made at a number of different amplitudes, for example; or you can graph overlaid response measurements for a multichannel recorder, using an Audio Precision switcher under ATS-2 control.

The nested sweep feature is enabled by entering settings into **Source 2**.

In a nested sweep, **Source 1** is still used as the primary independent variable. When the sweep starts, ATS looks first to **Source 2** for the initial Start setting, then begins the first **Source 1** sweep. When that is completed, ATS then increments by one **Source 2** step. Then the **Source 1** sweep is made again. This process is repeated until all the steps defined in **Source 2** have been completed.

The X-axis scaling and calibration are taken from the **Source 1** settings. The **Source 2** parameter values are not directly visible on the graph, but these values are displayed in the **Graph Legend** (see page 295).

The **Source 1** and **Source 2** controls and browser operate identically.

Pre-Sweep Delay

The pre-sweep delay setting enables you to specify a time delay between the **Go** command and the actual beginning of the sweep, to allow for stabilization of the generator or the device under test, if necessary. This can help eliminate transient “glitches” at the start of a sweep. The allowable pre-sweep delay range is 0.000 seconds to 4.000 seconds; the default setting is 200 ms.

The pre-sweep delay is also applied before batch-mode DSP sweeps. Acquisition of signal into any of the Analyzer FFT (batch-mode) programs will not begin until the pre-sweep delay period (or 200 ms, whichever is greater) has passed.

In nested sweeps (using **Source 2**), the pre-sweep delay is applied at the beginning of each nested sweep.

Pre-Sweep Delay and Auto On

The initial transient created when a generator is turned on requires a delay before measurement to allow the generator, DUT, ranging and analyzer circuits to stabilize. When **Auto On** is enabled, the **ON** command is ap-

plied to the generator at the moment the sweep starts. To avoid the effects of the switching transient, set the **Pre-Sweep Delay** to a sufficient time, in many cases **.5 sec** to **1 sec** or more.

See pages 79 and 101 for more information about **Auto On**.

Table Sweeps

The sweeps we've looked at so far step through a range of values set in **Source 1**, controlling ATS instrument settings as the independent variable.

In a table sweep, the points of measurement are read from a table rather than taken from Source 1 the Start / Stop settings. You must still use the **Source 1** browser to choose the ATS instrument parameter that is to be used, but the range, direction, number of steps and the step size are all determined by the values entered in the sweep table.

This allows you to specify exact values and precise step sizes, which do not need to be regularly spaced. The sweep will move in whatever direction the values dictate, including forward or backward.

A sweep table is assigned to a sweep by "attaching" an appropriate AP data file. This is usually a file saved as an AP sweep data file, with the extension **.atss**. Click **Table Sweep** on the Sweep panel to view the file attachment browser. Find the **.atss** file you want to attach to your sweep and select it.

*Other AP data file types can also be attached as sweep files.
See **More About Using AP Data Files** on page 314.*

Before you attach the file, you must indicate to ATS which column of data in the table will be your independent variable, that is, which values will drive your sweep. Drop the **Column** field list on the browser and choose the column. If you are not sure which column you want, click the **Edit** button on the browser. This opens the Attached File Editor. You can view the table in the Attached File Editor and decide which column to choose. For more information on using the Data Editor and the Attached File Editor, go to Chapter 18.

The Attached File Editor is similar in appearance to the Data Editor, but the two have different functions.

When you are ready, click **OK**. The table will be attached to your sweep. You will notice that the **Steps** and **Stepsize** (or **Multiply**) fields have disappeared from Source 1, since they are no longer needed.

The **Start**, **Stop** and scale controls (**Log**, **Lin**, **Div** and **Auto**) are still available, but they no longer affect the performance of the sweep; they are only used to set the graph calibration and divisions. If you set the graph range in **Start** and **Stop** narrower than the range of the values in the sweep table, there will be points beyond the range which will not be plotted.

If instead of attaching an existing sweep table you would like to create your own, open the Data Editor panel by clicking the **Data Editor** button or using the Menu command **Panel > Data Editor**. You can enter, edit and delete values in the Data Editor to create your sweep table. Save the contents of the Data Editor as a sweep data file (.atss) using the Menu command **File > Save As > Sweep Tables**.

External Sweeps

All the sweeps we've discussed are *internal* sweeps; that is, the parameters and settings for the **Source 1** independent variable come from within the ATS-2 system, whether they are generator settings or data from a sweep table.

It is also possible to use an external signal as the independent variable. For example, a CD alignment disc may have a frequency sweep as a test track, and to test the playback capabilities of the CD player you may want to perform a response sweep with the disc as the signal source. This is called an *external sweep*.

The Sweep panel settings for an internal sweep not only set and sweep the generator parameters but also configure the sweep and graph engines for the display you desire. **Start** or **Stop** values and sweep direction, for example, are clearly defined. An internal sweep is defined by panel settings.

The **Source 1** independent variable in an external sweep, however, is driven by meter measurements, not by generator settings. In the case of the CD test disc, the measured frequency of the received test signal becomes the **Source 1** information, and the measured channel A and B amplitudes become the **Data 1** and **Data 3** results.

So in an external sweep, ATS must monitor the input signal *readings* to extract sweep controls from that signal. ATS has no way to predict the behavior of an external signal, and you must specify considerations such as the range and direction of the sweep, when to graph a point, or when to start and end the sweep.

Even with these specifications, extracting usable sweep controls from input signals can be difficult. Noise, flutter, or level changes can all cause an external sweep to act erratically or graph spurious points.

ATS provides a number of special controls to set up an external sweep and produce stable results.

External Sweep Operation

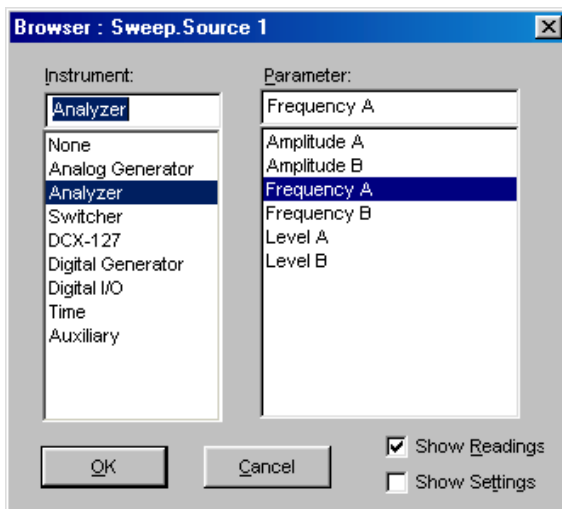

Figure 218. Source 1 Instrument Browser in External Sweep mode.

To enable the External Sweep mode choose an instrument *reading* instead of a *setting* for the independent variable in the **Source 1** browser. When this is done, the controls available in the **Source 1** section of the Sweep panel will change to External Sweep controls. The **Steps**, **Stepsize / Multiply** and **Table Sweep** controls disappear, and **Spacing**, **End On**, **Min Lvl** and the **Min Lvl I.D.** fields appear in their place, as shown in Figure 219.

For a frequency sweep, the **Source 1** instrument reading will be an Analyzer frequency meter; for amplitude-controlled sweeps a level or amplitude reading is normally used.

*Before acquisition the reading must also satisfy the requirements entered in the Settling panel for that instrument. See **Sweep Settling**, page 278.*

Figure 219. Source 1 External Sweep Controls

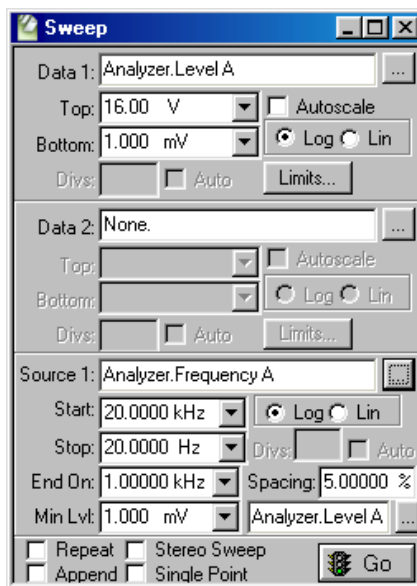

Start and Stop

In an External Sweep, the extent and direction of the sweep is not under ATS's control. You must inform the Sweep panel of the range in which you expect the signal, and the direction you expect it to move. This allows ATS to track the signal for proper plotting on the graph.

Enter the expected values in the **Start** and **Stop** fields. If the value of **Start** is less than **Stop**, ATS will expect that the sweep will proceed upward, in the direction of lesser to greater. If **Start** is greater than **Stop**, ATS assumes that the sweep will proceed downward.

If the sweep actually moves in the direction opposite to that indicated by the **Start** and **Stop** field values, ATS cannot plot a meaningful graph.

The **Start** and **Stop** values and associated units also set the graph scales and calibration, and the field values provide references for other External Sweep controls such as **End On**.

Spacing

The **Spacing** field helps to determine the step size within the sweep. **Spacing** is entered as a percentage, and the range for each new data point is the value of the last point plotted, plus or minus the **Spacing** percentage. At the beginning of a sweep, the **Start On** rules (below) determine whether or not **Spacing** affects the acquisition of the first plotted point.

End On

The **End On** field in the **Source 1** section of the Sweep panel allows you to set the conditions under which an External Sweep test will terminate. An External Sweep test can be manually terminated by pressing the **Esc** key or clicking on the **Stop** button when it is apparent that the sequence of test tones has ended, but **End On** can terminate the sweep automatically.

End On follows this logic:

- if the value set in **End On** equals the **Stop** value (plus or minus the **Spacing** percentage), the sweep will terminate when the **End On** value occurs;
- if the value set in **End On** does *not* equal **Stop** (\pm **Spacing**) and is outside the range set by **Start** and **Stop**, the sweep will terminate when the **End On** value occurs;
- if the value set in **End On** does not equal **Stop** (\pm **Spacing**) and is *within* the range set by **Start** and **Stop**, the sweep will terminate on a second occurrence of the **End On** value.

This produces several different behaviors:

- The first case, where **End On** equals **Stop** (\pm **Spacing**), allows you to set **End On** at the end of your desired sweep. The last value acquired (**Stop** \pm **Spacing**) will be graphed.
- The second case, where **End On** does not equal **Stop** (\pm **Spacing**) and is outside the **Start–Stop** range, allows you to set **End On** beyond your desired sweep. You can, for example, place an out-of-band cue tone after the swept tones to terminate the sweep.
- The third case, where **End On** does not equal **Stop** (\pm **Spacing**) and is within the **Start–Stop** range, allows you to set **End On** to a value in the mid-range of your desired sweep. This accommodates, for example, a frequency test which sweeps across the desired spectrum and then returns to a mid-spectrum tone. If **End On** is set to that mid-spectrum tone, it will note the first occurrence of that tone as the sweep passes through it, and at the return the second occurrence of the tone will terminate the sweep. Many pre-recorded test tapes and CDs are made just this way, with, for example, a 20 Hz to 20 kHz sweep followed by a 1 kHz reference tone. When performing split-site measurements with ATS-2 or another Audio Precision System, the remote generator can be set up so that the generator dwells at its Generator panel setting (which can be a mid-band reference frequency) before and after a Source 1 frequency sweep.

Min Lvl

The value set in the **Min Lvl** (minimum level) field allows you to exclude any measurements below a preset level, as measured by the meter specified in the field just to the right of **Min Lvl**. This acts as a “noise gate,” preventing noise or low-level signals from interfering with the process. When **Min Lvl** is set very low, all signals will exceed the setting and will be plotted; when **Min Lvl** is set very high, no signals will exceed the setting and nothing will be plotted. This is useful in directing the sweep to ignore the silence between tracks on a test CD, for example.

Start On Rules

Additional external sweep controls called the **Start On Rules** have been added as OLE commands available to ATS through the AP Basic language. A macro has been created to give you easy access to the **Start On Rules**.

On the ATS Menu bar, click **File > Open > Macro** and select the file xstart-onrules.atsb. Then, on the Menu bar, click **Macro > Run**. The following dialog box will appear:

Figure 220. External Sweep “Start-On” Rules Panel.

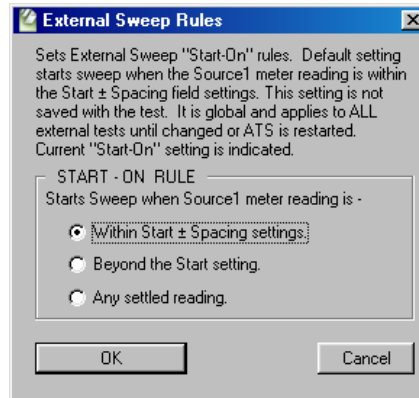

Selection of a Start-On Rule remains in effect until a new selection has been made or until the ATS control software has been closed. The default **Start-On Rule** is **Within Start ± Spacing settings**.

In an external sweep, the **Go** button enables the acquisition of sweep measurements; however, no data will be acquired until the externally-generated signal satisfies the conditions set by the **Start On** rule which is in effect.

There are three **Start On** rules:

- **Within Start \pm Spacing settings.**

The sweep starts on a settled reading that is above the **Min Lvl** value, and that is also within the tolerance set by applying the **Spacing** percentage to the **Start** value. For example, if **Start** is 20 Hz and **Spacing** is 5%, a reading between 19 Hz and 21 Hz will start the sweep. Or, if **Start** is 1 V rms and **Spacing** is 10%, an amplitude between 0.9 and 1.1 V rms will start the sweep.

This rule governs the normal behavior of external sweeps. The other two **Start On** rules are:

- **Beyond the Start Setting.**

The sweep starts on a settled reading that is above the **Min Lvl** value and exceeds the **Start** value in the sweep direction (up or down, as determined by the relative values of the **Start** and **End** settings). No data is collected until the **Source1** meter reading passes (or equals) the **Start** value.

- **Any Settled Reading.**

The sweep starts on a settled reading that is above the **Min Lvl** value, without regard to the value in the **Start** field. Sweep measurements are collected in the direction set by the **Start** and **Stop** field values. In a sweep with **Start** at 20 Hz and **Stop** at 20 kHz, a 1 kHz measurement will not accept the next value until 1 kHz + **Spacing** is satisfied. Under this rule, the data collected can include values above or below the sweep graph limits set in **Start** and **Stop**.

Some Hints

Internal sweeps, and some external sweeps, are called *step sweeps* because the independent variable is moved across the sweep range in discrete steps. Many external sweeps, however, move across their range in a continuous change of values. These are called *continuous sweeps* or *glide sweeps*.

Since the signal is gliding continuously from one value to another in a glide sweep it will never stabilize and settle as it will in a step sweep, which pauses at each step for some period of time. To acquire these continuously changing values, ATS's sweep settling features must be disabled. See **Sweep Settling** on page 278.

On the Settling panel, set the **Analyzer.Frequency** settling **Algorithm** to **None** and **Delay** to **0.00**.

Also, check your **Min Lvl** settings. The default meter assigned to make the **Min Lvl** reading is **Analyzer.Level A**, but a browser can offer you a selection of other sources. Be sure the meter that you have selected is the

appropriate meter for your test, that you have considered the effect of any filters you may have attached to the meter, and that the **Min Lvl** threshold setting is correct.

External Stereo Sweep

External sweeps can also be configured as stereo sweeps by clicking the **Stereo Sweep** checkbox on the Sweep panel. ATS will automatically set the **Data 3** (and **Data 4**, if necessary) settings to match the **Data 1** (and **Data 2**) settings for stereo pairs. See **Stereo Sweeps** on page 267 for a full discussion.

Since ATS is entirely dependent upon the External signal in an External sweep, the automatic switching for the Stereo sweep crosstalk feature (page 267) for ordinary sweeps is not available for external sweeps.

External Single Point Sweeps

External sweeps can also be configured as Single Point sweeps by clicking the **Single Point** checkbox on the Sweep panel. See **Single Point Sweeps** on page 268 for a full discussion.

When set up for an External Single Point Sweep, ATS will wait until the input signal satisfies all the criteria you have set, including **Min Lvl**, the operative **Start-On Rule**, and **Settling**. When the **Source 1** reading fulfills these requirements, a **Data** reading will be taken.

An external single point sweep is useful to extract a single reading under a specific condition, or permit an AP Basic macro to continue only at the point that a measured parameter reaches a certain value.

An X-Y graph will not be drawn for a single-point measurement. The result can be viewed in the Data Editor table.

Time Sweeps

In addition to generator sweeps and external sweeps, ATS can graph data against time in a Time Sweep, producing a “chart recorder” style measurement. Time Sweeps are commonly used to measure instability or drift of audio parameters over time, or to plot moment-to-moment variations such as wow and flutter or phase jitter.

To run a Time Sweep, open the **Source 1** browser and select **Time** as your instrument and **Sweep Time** as the parameter. The **Show Readings** and **Show Settings** checkboxes have no effect on your parameter choices, since you are neither setting a generator nor tracking a measured reading.

The time interval starts when you click the Sweep **Go** button. You can view the Time Sweep from the beginning if you have entered **0.000 s** as your **Start** value. The sweep will continue until your **Stop** value is reached.

As with generator sweeps, you can enter the number of **Steps** (or step **Multiply**, in **Log** mode) or **Stepsize** as **Source 1** settings. For very closely spaced readings, ATS's ability to make measurements will be limited by other factors, such as Sweep Settling or meter detector reading rates. For example, if your selected reading rate is 8 readings per second, two consecutive readings cannot be closer than 125 ms.

At the very short reading intervals which are necessary to acquire measurements which are close together, the speed of your computer and the number of panels open in ATS and the windows open in other software running will have a noticeable effect on the speed of acquisition.

Sweep Settling

Most of the measurements in ATS-2 are taken continuously, often at rates as high as 32 or 64 readings per second. The real-time numeric meter displays show this “raw” data, and you will notice that the readings jump around when the signal contains transients or other momentary disruptions. We mentally “settle” these measurements as we observe them, ignoring the brief extremes and taking the perceived average or trend as the reading.

If raw readings like this were plotted without some way of excluding the transients, there would often be meaningless points spread across the graph.

The process of sweeping can also add spurious results to the measurement. This is because the Sweep panel is stepping through **Source 1** parameter changes, and with each change both the system generators and typical DUTs need a moment to stabilize.

To address these considerations, ATS has a sweep Settling panel to set a list of criteria which the measured parameter must satisfy before being acquired. These settling values can be adjusted for various measurement conditions and goals, with the result that clear and meaningful graphs (or tables of data) can be obtained.

ATS normally obtains settled data by discarding early measurements and plotting only later, repeatable values after both the DUT and the ATS-2 generator and analyzer have stabilized. ATS has default settling values in place when you launch the software, but you can reset the defaults on the Settling panel to optimize settling for different measurements. Set-

ting values are saved when you save a test file, and are recalled when a test file is loaded.

The settling values only affect real-time sweep measurements, and, in AP Basic macros, OLE meter readings. ATS panel meter readings and batch mode instrument readings are not settled.

The Settling Panel

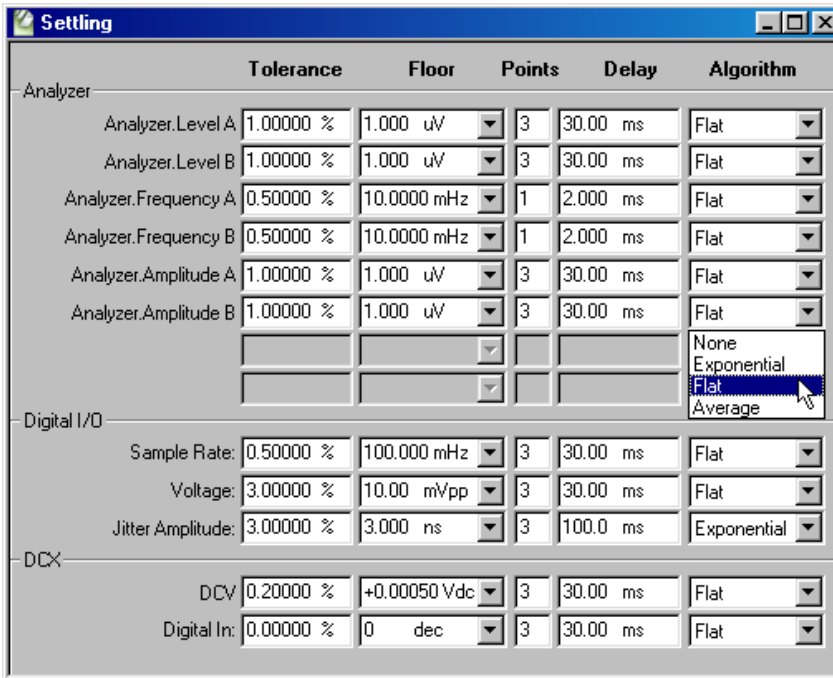

Figure 221. The sweep Settling panel.

The ATS Settling panel is available by selecting **Panels > Settling** from the Menu bar or by clicking the **Settling** button on the toolbar; you can also launch the Settling panel by selecting **Sweep > Show Settling Panel** from the Menu bar.



The Settling panel allows you to set a number of settling parameters for each of the meters available in an ATS sweep. The Analyzer meters available on the Settling panel will change with the Analyzer instrument you have selected.

Settling Concepts

Since much of the signal disruption occurs at the beginning of a sweep step because of instrument and DUT stabilization, the ATS settling function first ignores early readings, and then calculates when a reading should be considered stable enough for data to be acquired.

The Settling panel offers two independent controls to accomplish this for each ATS meter: the Settling **Delay** time and the Settling **Algorithm** selection.

Settling Delay Time

The first task in settling is to ignore all early readings. Any measurements which arrive within the period between the beginning of a sweep step and the time set in the **Delay** field are discarded.

Typical default **Delay** settings are in the 20 ms to 100 ms range, depending on the instrument selected.

The **Delay** value is independent of the **Algorithm** choice, and is effective even if the **Algorithm** selection is **None**. To disable the sweep settling delay for a particular instrument, enter **0.00** as the value in the **Delay** field.

For Time Sweeps where it is desired to make as many measurements per second as possible, the **Delay** value should be set to **0.00** and the Algorithm selection should be **None**.

All settling functions must be disabled when performing an External Sweep which has a continuously moving independent variable (a glide sweep). See **Some Hints** on page 276.

Algorithm Selection

In addition to setting a **Delay** time, you can also select one of three (or **None**) Settling Algorithms to evaluate the stability of your signal.

The three Settling Algorithms are:

- **Exponential**

Exponential usually provides consistent results in the minimum length of time. Since typical device transients tend to fall off in an exponential fashion, this can be a very useful settling algorithm, especially for analog signals.

- **Flat**

Flat provides highly repeatable results, but often requires more settling time than **Exponential**. **Flat** is the default algorithm selection.

■ Average

Average is useful for noise measurements and for other random or aperiodic signals.

The algorithms look to the Settling panel for values to use in making their evaluation of signal settling. **Average** uses only the **Points** value; **Exponential** and **Flat** also look to the values set in the **Tolerance** and **Floor** fields.

As mentioned in **Settling Delay Time**, above, all measurements taken during the initial **Delay** period are discarded before ATS begins evaluating the signal with any of the selected algorithms.

Exponential Settling Algorithm

The **Exponential Algorithm** reports a data point after a certain number of readings (the value set in the **Points** field) fall within an exponential settling criteria envelope, an example of which is shown in Figure 222. The shape and calibration of this envelope are determined primarily by the value set in the **Tolerance** field. The **Floor** field, which is explained below, keeps the size of the envelope from decreasing to zero as the value being measured becomes very small.

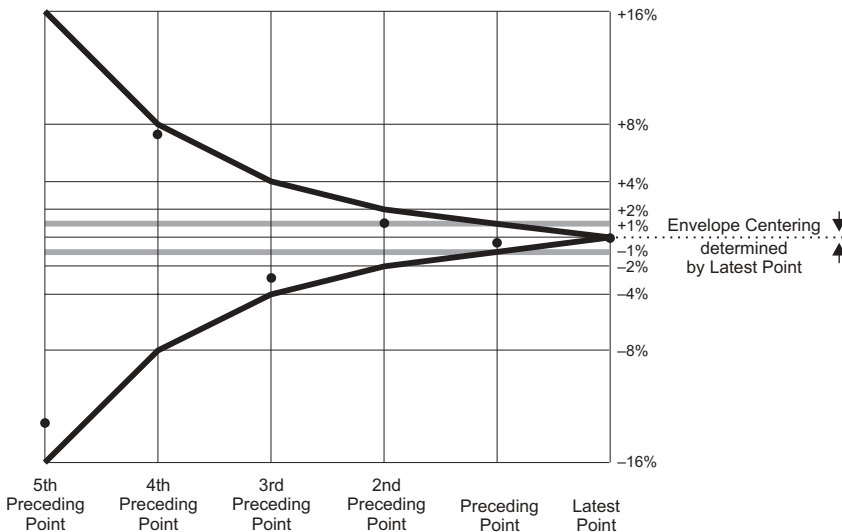

Figure 222. Successfully settled reading using Exponential method, where **Tolerance** is set to 1 % and **Points** is set to 5.

To satisfy the **Exponential** criteria, a measurement N must agree with the immediately preceding measurement $N - 1$, within the **Tolerance**

value; and must also agree with measurement $N - 2$, within twice the **Tolerance** value; and with measurement $N - 3$, within four times the **Tolerance** value, and so on. This relationship must hold for the number of consecutive measurements set in the **Points** field. Figure 222 shows a series of points which have fallen within the specified **Exponential** settling criteria envelope.

Flat Settling Algorithm

The **Flat Algorithm** reports a data point when these two conditions are met:

- The signal is so stable that the difference between any two consecutive readings (expressed as a percentage) is less than the percentage value specified in the **Tolerance** field.
- This degree of stability is held through the number of readings specified in the **Points** field.

The settling criteria envelope for the **Flat** algorithm is a pair of horizontal lines at the plus-and-minus tolerance percentage values. The gray lines on Figure 222 illustrate the **Flat** envelope for a 1% **Tolerance** setting.

The **Flat** algorithm guarantees that the signal transients have been settled to the specified **Tolerance** for some time. This tends to take longer than the **Exponential** algorithm.

Average Settling Algorithm

The **Average** settling algorithm takes the mathematical average of the number of consecutive measurements entered in the **Points** field and reports the result as a data point. The Average algorithm is particularly useful when the signal is fundamentally noisy and might never settle within a practical tolerance.

Settling Tolerance

Settling Tolerance represents the amount of variability you are willing to accept from test to test. A tolerance of 0.1 % (about 0.01 dB) may be appropriate for frequency response tests on a DUT with excellent characteristics; at the other extreme, tolerances of 10 % to 25 % may be necessary to obtain data under noisy conditions. The default value is 1 %.

Settling Floor

When working near the very bottom of the dynamic range for a particular ATS instrument, the difference between two adjacent values or quantization levels can be large compared to the criteria in the settling algo-

rithm. At levels greater than a few percent of full scale on the instrument, the value set in the **Tolerance** field is normally the determining parameter, but close to the bottom of a measurable range another technique is needed to keep the settling from slowing down the sweep or even stopping it entirely.

The **Floor** setting provides this protection. Whenever the value set in the **Floor** field is larger than the product of the measured signal and the **Tolerance** percentage, the algorithm uses the **Floor** value instead of waiting for the signal to satisfy the **Tolerance** criteria.

For example, with a **Tolerance** of **1%** and a **Floor** setting of **1 μV** , the **Floor** takes over when the measured signal drops to **100 μV** .

The default values of **Floor** for each ATS meter are chosen to be approximately the resolution of that meter on its most sensitive range. Since resolution increases as the reading rate slows, it may be appropriate to change the default **Floor** values when the reading rate is fixed at a specific value.

Settling Issues for Specific Instruments

Settling for each meter in ATS is independently controlled by its own row of fields on the Settling panel.

Audio Analyzer Reading meter settling values are stored independently for each Audio Analyzer mode. For example, the settling values for **Audio Analyzer Amplitude A** and **B** are independent of the settling values for **Audio Analyzer THD+N Amplitude A** and **B**.

The Audio Analyzer **Phase** mode has no **Tolerance** field. The acceptable variability for this meter should be entered in the **Floor** field in degrees. An entry of **+10.00 deg**, for example, sets a 10-degree-wide window of acceptance for the selected algorithm to use in calculation.

Timeout

It is possible with extremely noisy signals that the instability of the measured parameter is consistently greater than the **Tolerance** value entered on the Settling panel, and that it is impossible to satisfy the Settling algorithm and get a settled reading.

The **Timeout** control exists to keep your sweep from running slowly or even locking up under these conditions. If a settled reading cannot be made within the period of time entered in the **Timeout** field, ATS will calculate the average value of the last 6 measurements, enter that value as a data point and move on to the next sweep step.

The default **Timeout** value (per step) is **4.000** s.

“Timed-out” points are marked with a white “T” at the top of the graph, above the plotted point. In the Data table, each timed-out point is indicated with the letter T following the data.

The Log File can also indicate timed-out data with several notices. See **The Log File**, page 364.

Chapter 16

Graphs

The graph is a central feature of the ATS-2 test and measurement system. As mentioned in Chapter 15, the functions of the Graph panel and the Sweep panel are closely related.

To configure and initiate any measurement to be plotted on a graph, you must go first to the instrument panels and then to the Sweep panel. Whether real-time Analyzer measurements or batch-mode FFT measurements, the Sweep panel is the control center.

Besides collecting the data for the graph display, the Sweep panel also sets the graph scaling and calibration; that is, the number and spacing of the vertical and horizontal graticule lines, and the X-axis and Y-axis numerical calibration and unit domain.

To change these graph parameters you must go to the Sweep panel. To view the graphed data in a tabular format, go to the Data Editor.

This chapter discusses the display controls available on the Graph panel.

The Graph Panel

The ATS Graph panel is available by selecting **Panels > Graph** from the Menu bar or by clicking the **Graph** icon on the toolbar.



The Graph panel plots the **Source** and **Data** information provided by the Sweep panel as X-Y relationships and provides a number of controls to modify the display, examine the traces with cursors, and add labels, comments and descriptive legend information to both the screen display graph and exported or printed versions of the graph.

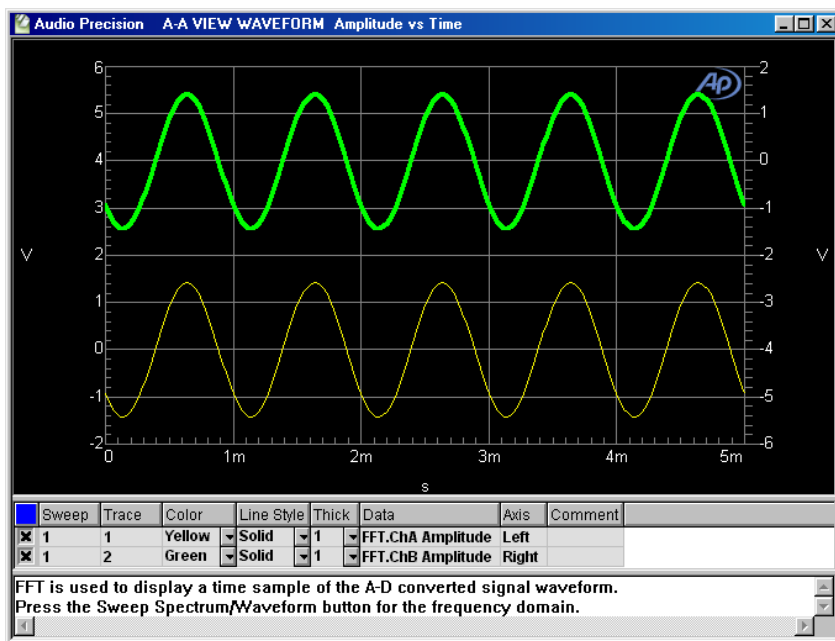

Figure 223. The ATS Graph panel.

The Graph panel itself can be resized to any practical dimension or aspect ratio you prefer by dragging the borders with the mouse pointer. Similarly, the **Legend** and **Comment** areas within the Graph panel can be adjusted for size.

Zoom

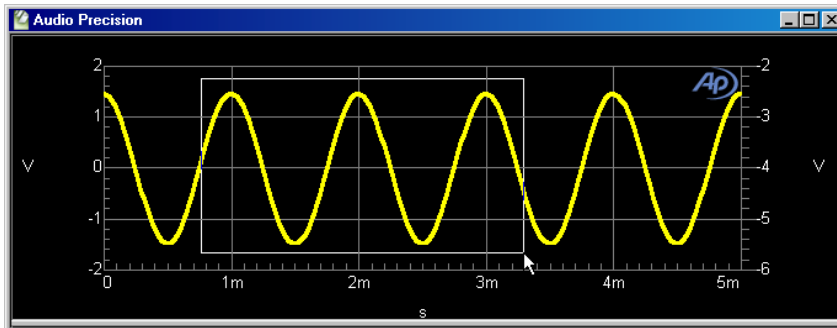

Figure 224. Dragging the mouse pointer across the graph to zoom.

You can “zoom in,” or magnify, any area of the graph by dragging the mouse pointer diagonally across the area you would like to magnify. Dragging the mouse pointer will draw a rectangle surrounding the area, as

shown in Figure 224. When you release the mouse button the graph will re-size itself to the rectangle you have drawn. You can perform this operation repeatedly to zoom further and further in.

When you are zooming into graphs of batch-mode measurements, the **Sweep Reprocess Data (Ctrl-F6)** command is normally sent to the Analyzer, requesting new data at the new sizing, so that the zoomed view will consist of the maximum possible resolution. This automatic reprocessing can be disabled on the Configuration panel by unclicking **Reprocess FFT data on zoom**.

*The **Sweep Reprocess Data** command is only effective if the acquired signal is still in the DSP memory. A test file loaded from disk, for example, will only contain the Graph data of the FFT being viewed when the test was saved, and increasing the resolution during a zoom is not possible.*

The Graph Options Menu

Click the right mouse button anywhere within the graph itself and the Graph Options menu will appear at the mouse pointer. This menu provides graph display and control options, as shown in Figure 225.

Figure 225. Graph Options menu.

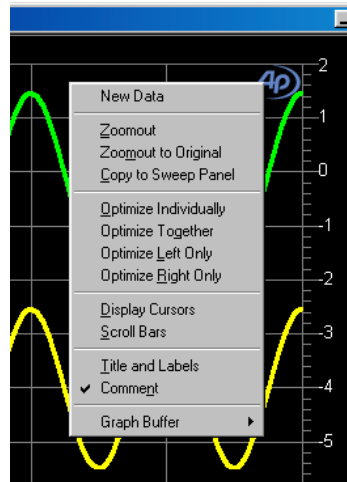

Zoomout

Choose **Zoomout** to reverse the last **Zoom** operation and reduce the magnification of the graph. If you have **Zoomed** repeatedly, clicking **Zoomout** repeatedly will back you out of your **Zoom** operations, one at a time.

If you are viewing batch-mode data, the **Zoomout** command will also send the **Sweep Reprocess Data** command, following the same behavior as with the **Zoom** command.

Zoomout to Original

Choose **Zoomout to Original** to return to the original graph sizing and coordinates in one step.

If you are viewing batch-mode data, the **Zoomout to Original** command will also send the **Sweep Reprocess Data** command, following the same behavior as with the **Zoom** and the **Zoomout** commands.

Optimize

The **Optimize** graph option is a method of zooming or magnifying the scale of the graph relative to the signal currently on the graph. An optimized graph will replot with new Y-axis coordinates for a maximum-resolution display of the signal.

Although you can optimize your graph at any time, it is usually most effective to optimize after the conclusion of a sweep. There are four **Optimize** choices:

- **Optimize Individually.**

This option is only available if both Y-axes are in use, displaying data mapped to the **Data 1** or **Data 2** coordinates. **Optimize Individually** sets the left Y-axis calibration for the best display of the **Data 1** set of values, and sets the right Y-axis calibration for the best display of the **Data 2** set of values.

- **Optimize Together.**

This option is only available if both Y-axes are in use, displaying data mapped to **Data 1** or **Data 2** and which use the same unit domains. **Optimize Together** sets both the left and right Y-axis and calibration for the best display of the entire range of values. This feature provides the ability to graphically compare traces (of the same unit domain) plotted against both left and right Y-axes.

- **Optimize Left Only.**

This option is only available if the left Y-axis (displaying **Data 1** and other data plotted against the **Data 1** axis) is in use. **Optimize Left Only** sets the left Y-axis calibration for the best display of the **Data 1** set of values.

- **Optimize Right Only.**

This option is only available if the right Y-axis (displaying **Data 2** and other data plotted against the **Data 2** axis) is in use. **Optimize**

Right Only sets the right Y-axis calibration for the best display of the **Data 2** set of values.

Unlike the **Zoom** features, the **Optimize** options do not issue a **Sweep Reprocess Data** command to the DSP for batch-mode FFT measurements. **Optimize** only operates on the graph display and does not plot new data.

*There is no need to reprocess batch-mode measurements after **Optimizing**. Reprocessing is necessary when the X-axis scale is changed; **Optimize** only re-scales the Y-axis.*

To return to your original display, click **Zoomout** or **Zoomout to Original**.

Copy to Sweep Panel

It is often the case that after zooming or optimizing your graph, you decide that you should re-run your sweep with Start, Stop, Top and Bottom settings which correspond to the coordinates on your resized graph. A shortcut to this adjustment is provided with the **Copy to Sweep Panel** selection. **Copy to Sweep Panel** takes the modified graph calibrations provided by **Zoom** or **Optimize** and writes these as settings in the Sweep panel. A new sweep will create a new graph with the X and Y-axis calibrations from the zoomed or optimized graph.

Display Cursors

ATS provides two cursors as aids in interpreting your graph. On the Graph Options menu, click **Display Cursors**. A green vertical line will appear, with two display boxes at the top and the bottom of the graph, adjacent to the cursor position.

The green line is actually two cursor lines on top of each other. The value in the bottom display box on the graph is the X-axis position of the cursors. The value in the top display box is the difference between the X-axis positions of the two cursors. Since the cursors begin in the same position, the initial difference is **0.00000**.

You can move the cursors by placing the mouse pointer on the green line and dragging sideways. The mouse pointer changes from the standard arrow to a dragging pointer, which indicates by a number whether you are dragging cursor 1 or cursor 2. When you have dragged the cursors off one another, each cursor is assigned its own X-axis display box.

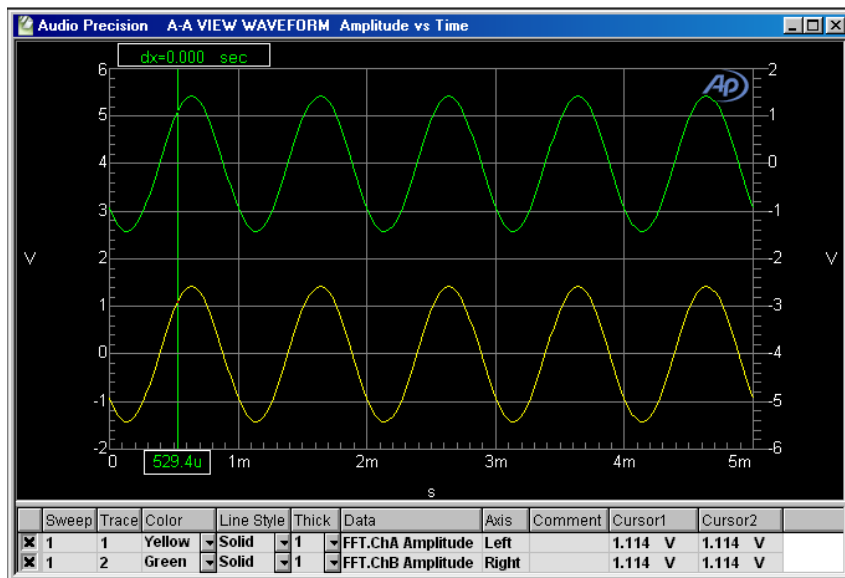

Figure 226. Graph Cursors on a deselected trace.

The cursors are shown as vertical lines whenever no **Data** traces are selected. To select a trace, click on the corresponding row shown in the graph legend; the legend row then appears highlighted to indicate that it is selected. See **Graph Legend** later in this chapter on page 295. The selected trace will be displayed as a thicker line, and the cursors will be assigned to that trace, displayed as crossed circles rather than vertical lines. The crossed circles can be dragged along the trace with the mouse pointer.

To deselect a trace, click the selected row a second time, clicking in the **Data** or **Axis** cell.

When a trace is selected, the Y-axis values at both cursor intersections are shown in new display boxes at the left side of the graph. A new display box also appears at the top of the graph, showing the difference between the two cursor Y-axis values.

You can also move the cursors on the graph using the keyboard. When the graph window is selected (click anywhere in the graph), the left and right arrows move a cursor horizontally across the trace. To select the other cursor, press an arrow key while holding the **SHIFT** key depressed, then move the cursor as before.

To move the cursors to another trace, press the up or down arrow keys.

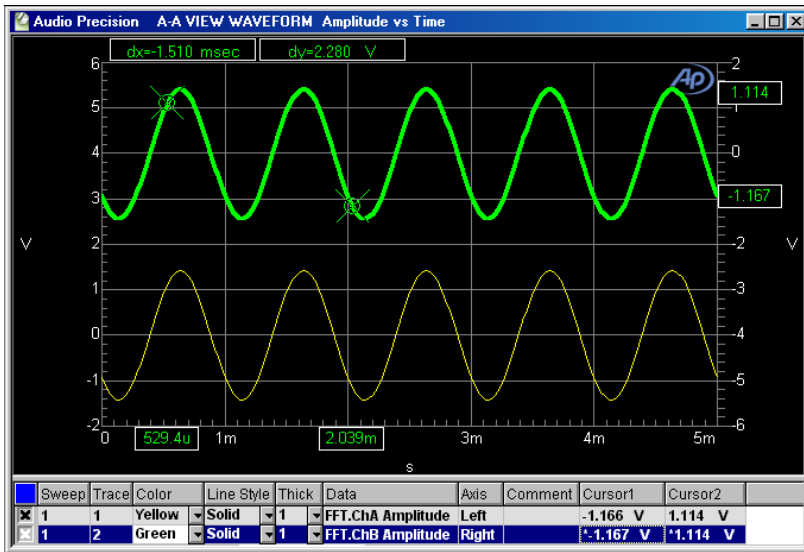

Figure 227. Graph Cursors on a selected trace with graph legend highlighted.

One or both cursors can be deselected entirely, or the two cursors can be assigned to different traces. In the **Legend** box, there are two columns labeled **Cursor 1** and **Cursor 2**. The data in these columns are the Y values for that particular cursor position. Two of the cells in the Cursor columns also have an asterisk (*) leading the numeric values. This asterisk indicates the cursor assignment.

To reassign one cursor to a different trace, first click the **Cursor 1** or **Cursor 2** column header, which will change to read *****Select*****. The entire column will be highlighted. Then, in that column, click the cursor cell in the row which corresponds to the trace where you would like to move the cursor.

To unassign cursors, select a cursor column as in the previous paragraph and click on the cell displaying the “cursor selected” asterisk. The cursor for that trace will be unassigned.

Cursors may be assigned to different traces only if the two traces have compatible parameters or unit domains.

If the graph is a nested sweep, the **Source 2** value for the selected trace is shown in a display box at the top of the graph.

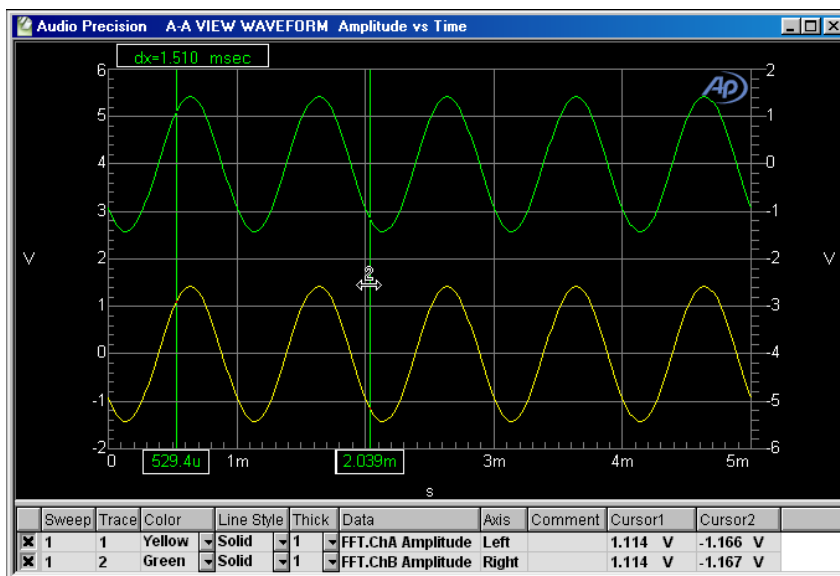

Figure 228. Graph Cursors 1 and 2 on different traces.

Cursors are restricted to regions of valid data, and cannot be moved to the blank regions on a trace that represent invalid results. See **Data Display Flags**, page 309.

Scroll Bars

If you have zoomed to a particular graph region and would like to view another region, open the Graph Options menu and click **Scroll Bars**. This provides an easy way to move around a graph which extends beyond the Graph panel window.

If you don't need to scroll, click again on **Scroll Bars**. The scroll bars will disappear.

Title and Labels

Figure 229. Graph Title and Labels dialog box.

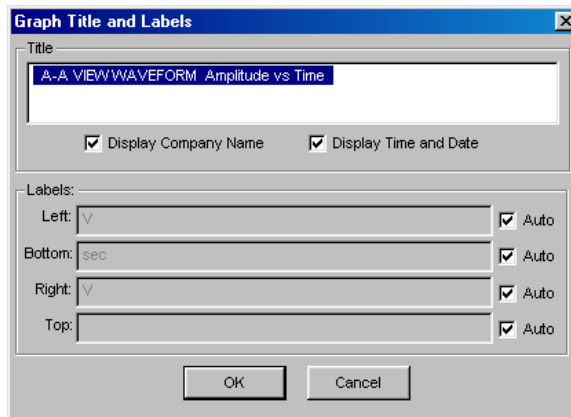

You can modify or add titles and labels to your graph. On the Graph Options menu, click **Title and Labels**. A dialog box will appear for you to make your entries. The **Company Name** setting has its source in the ATS Configuration panel, where you can enter a company name or other information.

Comment

You can optionally enter comments in the **Comment Edit** box, which is displayed on the Graph panel below the **Graph Legend**. On the Graph Options menu, click **Comment** to view the **Comment Edit** box on screen.

Your comments will always print at the bottom of a tabular data printout (**File > Print > Data**). When printing a graph (**File > Print > Graph**), you have the option of printing the comments or not, depending on your selections on the **Page Setup** dialog box, discussed on Page 330.

New Data

To clear the graph and the Data Editor, click **New Data** in the Graph Options menu. This has the same function as the command **File > New > Data**. This command actually removes the data from memory, not just from the display, and cannot be undone.

Graph Buffer

Figure 230. Graph Buffer commands.

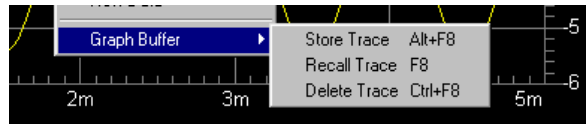

The Graph Buffer is a dedicated display memory in which you can store a trace (or set of traces) as a reference, and then recall the reference for comparison to a graph of current data. When you click Graph Buffer a small submenu appears with these choices:

- **Store Trace**

Click **Store Trace** to put the traces currently on the Graph panel into the Graph Buffer memory. You may also use the keyboard combination **ALT+F8**.

- **Recall Trace (Hide Trace)**

This choice toggles between **Recall Trace** and **Hide Trace**. The stored reference trace appears in the color gray on the screen, and can be switched on and off with this command. You may also use the keyboard shortcut **F8** as a toggle.

- **Delete Trace**

Click **Delete Trace** to clear the Graph Buffer memory. You may also use the keyboard combination **CTRL+F8**.

This feature allows you to use a measurement of a specific unit or condition as a visual reference for comparison or adjustment of other units.

Reference traces are retained and properly plotted even if you change graph scaling and calibration, including the use of zooming and optimization. Units of measurement can be changed as long as the unit domain remains the same (volts to watts to dBu, for example).

Reference traces are *NOT* retained through changes between analog and digital domain, or when plots are changed from absolute units to ratio units.

Reference traces are displayed in the color gray.

Graph Legend

	Sweep	Trace	Color	Line Style	Thick	Data	Axis	Source 2	Comment	Cursor1	Cursor2
✕	1	1	Green	Dot	2	DSP Anlr.THD+N	Left	: 10.00 uFFS=DGen.Ampl		-44.942 dB	-44.847 dB
✕	1	2	Yellow	Solid	3	DSP Anlr.THD+N	Right	: 10.00 uFFS=DGen.Ampl		*0.57263 %	*0.57237 %
✕	2	1	Yellow	Dash DotDot	7	DSP Anlr.THD+N	Left	: 14.68 uFFS=DGen.Ampl		-48.175 dB	-48.281 dB
✕	2	2	Red	Solid	1	DSP Anlr.THD+N	Right	: 14.68 uFFS=DGen.Ampl		0.38570 %	0.38094 %
✕	3	1	Red	Dash Dot	2	DSP Anlr.THD+N	Left	: 215.4 uFFS=DGen.Ampl		-51.509 dB	-51.615 dB
✕	3	2	Magenta	Solid	1	DSP Anlr.THD+N	Right	: 215.4 uFFS=DGen.Ampl		0.02658 %	0.02595 %

Figure 231. The Graph Legend.

On the Graph panel immediately beneath the graph itself is a display called the Graph Legend. The Legend displays one row for each graph trace in memory, showing information about the display of that trace and providing drop-down lists to modify some of the display parameters. If a limit file has been loaded, the limit traces appear in the Legend as well.

The Legend columns are:

- **(No Title)**
The leftmost column selects which **Data** rows are plotted as traces on the graph. Selected rows show an “X” in this column. The title box for this column is blue when the Graph Legend is selected and gray otherwise.
- **Sweep**
When more than one sweep is in memory (in cases of appended sweeps or nested sweeps) this column identifies the trace or traces associated with each sweep. The sweeps are numbered sequentially.
- **Trace**
When more than one set of data is associated with a sweep (in cases where Data 2 through Data 6 are used), each data set will produce an additional trace. The traces are numbered sequentially for each sweep. The trace numbers correspond with the sweep data numbers.
- **Color**
The **Color** column shows the color currently assigned to each trace, and offers a drop-down list so that you can change a trace’s color.
- **Line Style**
The **Line Style** column shows the line style currently assigned to each trace, and offers a drop-down list so that you can change a trace’s line style.
- **Thickness**
The **Thick** column shows the line thickness currently assigned to each trace, and offers a drop-down list so that you can change a trace’s line thickness. Thicknesses greater than **1** can only be applied to **Solid** line style traces.
- **Data**
The **Data** column shows the ATS instrument and parameter associated with that trace.
- **Axis**
The **Axis** column shows whether the trace is calibrated and scaled on the left or right Y-axis.

- **Source 2**

If **Source 2** is used (a nested sweep), the ATS instrument, parameter and value associated with that trace are shown in this column.

- **Comment**

The trace Comment column provides a cell to enter an optional comment for each trace row in the Graph Legend.

- **Cursor 1**

If cursors are enabled, this column shows the value of the associated trace at its intersection with **Cursor 1**. An asterisk in the cell indicates that the cursor is assigned to that trace.

- **Cursor 2**

If cursors are enabled, this column shows the value of the associated trace at its intersection with **Cursor 2**. An asterisk in the cell indicates that the cursor is assigned to that trace.

The **Source 2** column and the **Cursor 1** and **Cursor 2** columns will only be displayed if these options are in use.

The Graph Legend box can be resized by dragging its top border with the mouse pointer. If the list of traces in the Legend is too long to display, scroll bars will appear on the Legend box for navigation. Column widths can also be resized by dragging the border between column headings with the mouse pointer.

Figure 232. Graph and Graph Legend showing data trace and upper and lower limit traces.

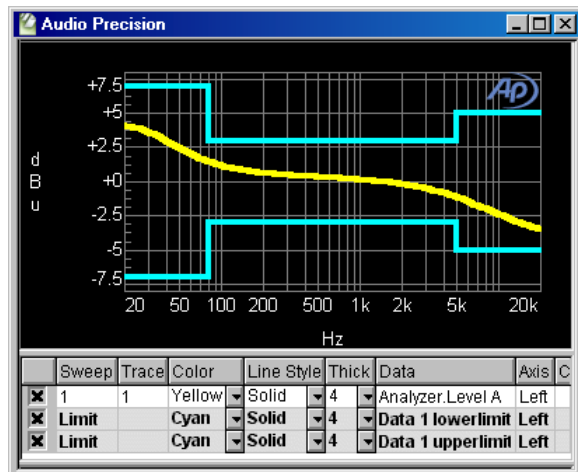

Graph Legend / Data Editor Linkage

The display of information in the graph Legend is visually linked with the tabular sweep data display shown in the Data Editor. For appended or

nested sweeps, this can help in identifying which line shown in the Data Editor is associated with a particular trace.

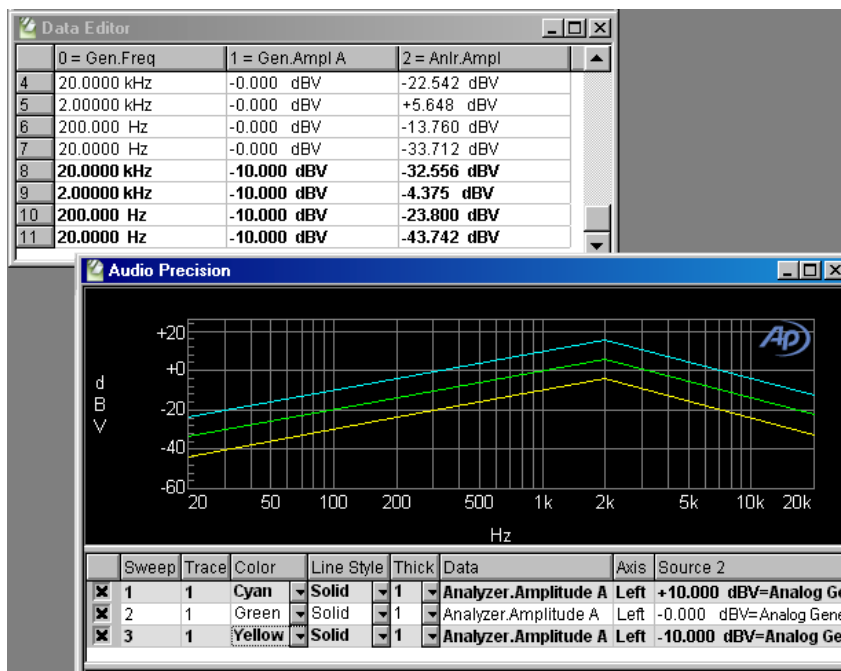

Figure 233. Graph Legend and Data Editor, showing the linked relationship of the typefaces used in the two displays, for a nested sweep.

This linkage in the displays identifies the correspondence between data and traces in two ways:

- Normal Type or **Bold Type**.
Alternate sets of traces in both the graph Legend and the Data Editor are displayed in alternating **bold** and normal typefaces. A **bold typeface** is used for odd-numbered sets of traces; a normal typeface is used for even-numbered sets of traces.
- Data Editor scrolling.
The Data Editor automatically scrolls so that the set of data corresponding to the trace selected in the Graph Legend is shown at the top of its window.

Graphing invalid or suspect data

Not all readings can be displayed on the Graph panel. A single-point sweep, for example, returns only one data point. This cannot be displayed on an ATS graph. See **Single-Point Sweeps**, page 268.

Invalid readings are skipped, leaving a blank region in the graph. Cursors are restricted to regions of valid data. If an entire trace consists only of invalid readings, the message “No Valid Data in Selected Trace” will be displayed. See **Data Display Flags**, page 309.

Occasionally Sweep Settling will “time out” before a final, settled reading can be made. In such cases, the unsettled data point is plotted but is flagged both in the Data Editor and on the Graph panel. Timed out points are marked with a white “ T ” at the top of the graph, above the plotted point. See **Timeout**, page 283.

When regulation is used, occasionally ATS’s attempt to regulate the data will be unsuccessful. In such cases, the unregulated data point is plotted but is flagged both in the Data Editor and on the Graph panel. Regulation failures are marked with a white “ R ” at the top of the graph, above the plotted point. See **Regulation**, page 355.

Trace Colors

ATS traces are normally displayed in one of six colors:

- cyan
- green
- yellow
- red
- magenta, and
- blue.

These colors can be automatically assigned by ATS according to the type of sweep and the settings made on the Configuration panel. The order of these colors is called the “color cycle,” and when ATS automatically increments colors it always does so following this order. The cycle “wraps back” from blue to cyan when the end of the cycle is reached.

The color gray is also available and can be manually assigned to any trace. However, gray is not part of the color cycle and is normally reserved as the color for reference traces recalled from the Graph Buffer.

Color Assignment for a New Test

When a single sweep is made in a new test, ATS normally chooses cyan as the color for the trace. However, if you have assigned a different color to a trace and subsequently run a new test without closing ATS, the color you have previously chosen will be the trace color for the new test.

Color Assignment for Multiple-Data-Set Sweeps

In a single sweep with more than one set of **Data** values being plotted, by default ATS assigns the **Data** traces colors according to this pattern:

Data 1	cyan
Data 2	green
Data 3	yellow
Data 4	red
Data 5	magenta
Data 6	blue

If the **Reset color cycle** checkbox in the Configuration panel is checked, each new sweep will assign colors to the Data sets in this way, whether or not you have made manual color changes in the Graph Legend.

If the **Reset color cycle** checkbox in the Configuration panel is unchecked, ATS will use this assignment of colors initially. If you manually change any color-to-**Data** assignment, ATS will maintain your new color assignments throughout subsequent sweeps.

See Chapter 25, **Configuration**.

Color Cycling in Nested and Appended Sweeps

When nested or appended sweeps are made, each **Data** trace in each sweep follows the color cycle pattern, picking up at the place in the pattern where the same **Data** trace of the previous sweep left off. For example, a **Data 1** trace which was green in a particular sweep would be displayed in yellow in the next appended or nested sweep.

Figure 234. Traces automatically sequence through the color cycle for appended data and nested sweeps.

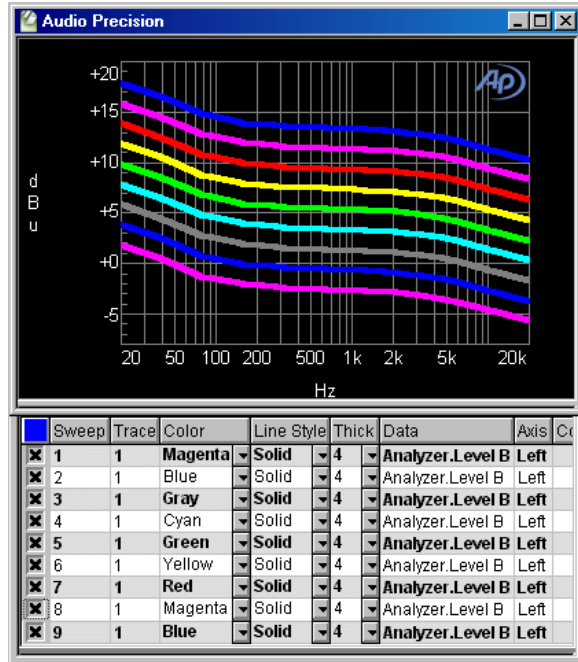

When a test file is opened, the first display will be the traces from the loaded test using the colors saved in that file. If new sweeps are appended to this test by sweeping with the **Append** box checked, the colors assigned to the appended sweeps traces depend on a Configuration setting:

- If the **Use Test Colors Only** checkbox on the **Graph** tab of the Configuration panel is unchecked, the trace colors will rotate through the color cycle, using the test colors as the starting point.
- If the **Use Test Colors Only** checkbox is checked, color cycling is disabled and each appended trace will maintain the trace color loaded in the test.

See Chapter 25, **Configuration**.

Color Cycling with Appended Files

When a current sweep is appended with sweep data from disk using the **File > Append** command, the colors assigned to the sweep traces from the appended file depend on a Configuration setting:

- If the **Cycle Trace Colors** checkbox on the **Graph** tab of the Configuration panel is unchecked, the appended file trace colors will come in without change.

- If the **Cycle Trace Colors** checkbox is checked, the colors of the traces appended from disk will move through the color cycle, using the last set of traces currently in memory as the starting point.

See Chapter 25, **Configuration**.

Chapter 17

Bar Graphs

Each ATS instrument has a number of settings and readings on its control panel; the Analog Generator, for example, has fields to set frequency and amplitude, and the Audio Analyzer has fields to read these parameters.

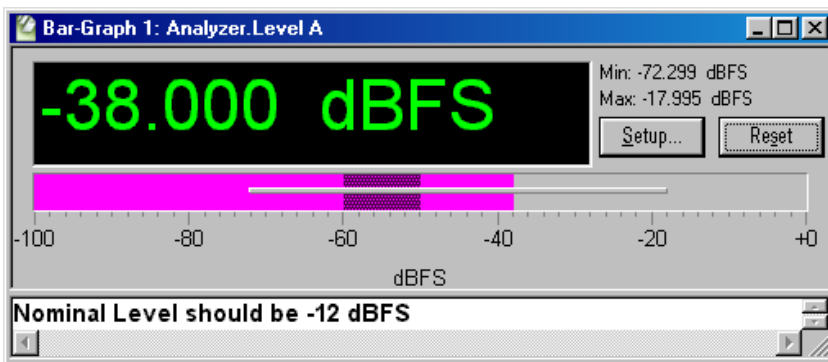

Figure 235. Typical Bar Graph reading, with optional comment.

Bar Graphs are graphical display panels that can be associated with instrument settings and readings for easier control and observation. Up to 32 Bar Graphs can exist simultaneously, associated with any combination of instrument parameters. Bar Graphs can be set to any size.

Bar Graphs are not related to the graphs controlled by the Sweep panel and displayed on the Graph panel.

Creating a Bar Graph

A Bar Graph can be associated with any ATS field that sets or reads a signal parameter.



To create a Bar Graph, click on the setting or reading field to be associated with the Bar Graph, then either click on the **Bar Graph** icon or choose **Panels > Bar Graphs > <new>**. A new Bar Graph will be created and associated with the parameter that you highlighted. If no appropriate field was highlighted, the default new Bar Graph association is with the Audio Analyzer Level Meter, Channel A. You can change the association at any time using the Bar Graph Setup panel, discussed below.

Figure 236. Creating a Bar Graph by right-clicking the mouse.



Another way to make a new Bar Graph is to right-click the setting or reading field in which you are interested, and click **Create Bargraph** from the menu which appears.

Bar Graph Setup

Click the **Setup** button to access the Bar Graph Setup panel. The **Setup** button may not be visible if the Bar Graph panel is sized too small.

Figure 237. Bar Graph Setup panel.

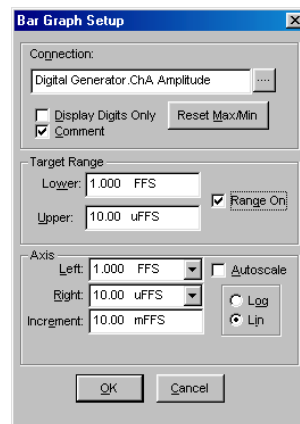

At the top of the Bar Graph Setup panel is a Connection browser, similar to the instrument browsers at **Source** and **Data** in the Sweep panel. You can select the instrument and setting or reading parameter for this Bar Graph using the Connection browser.

Checkboxes allow you to **Display Digits Only** or toggle the **Comment** display.

Target Range displays a dark bar on the Bar Graph to give a visual indication of a range of interest. You can turn the Target Range display on or off by checking the **Range On** checkbox. Set the extents of the Target Range in the **Lower** and **Upper** fields in this area.

Target Range is enabled only on a Bar Graph configured for readings.

In the Axis area you can set up the range of the Bar Graph display, or click **Autoscale** to let ATS scale the display in response to the signal.

For most parameters you can make the choice between a logarithmic or linear scale by clicking the **Log** or **Lin** option buttons.

The **Increment** field is only available for settings, and enables you to specify the minimum increment by which the setting can be changed.

Using a Bar Graph for Readings

To use a Bar Graph for readings, you must create the graph while an instrument reading field is highlighted, or you must select an instrument reading parameter from the Connection browser in the Bar Graph Setup panel.

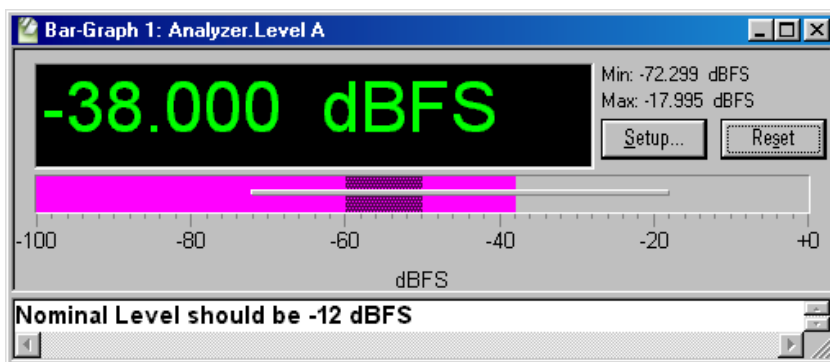

Figure 238. Typical Bar Graph for readings, with optional comment.

Bar Graph readings are displayed as green digits and also as a horizontal magenta bar. The bar will respond to the signal reading in real time, simulating an analog meter. You can remove the bar display by selecting **Display Digits Only** on the Setup panel.

When the magenta bar moves to show a changing signal, a narrow gray horizontal bar will appear on the magenta bar to indicate the history of minimum and maximum readings. This can be reset by clicking the **Reset** button or the **Reset Min/Max** button on the Setup panel.

You can also add a Target Range display bar to a readings Bar Graph. Target Range displays a dark bar over the magenta bar to give a visual indication of a range of interest. Refer to the previous **Bar Graph Setup** topic for information on setting a Target Range.

Using a Bar Graph for Settings

To use a Bar Graph for settings, you must create the graph while an instrument setting field is highlighted, or you must select an instrument setting parameter from the Connection browser in the Bar Graph Setup panel.

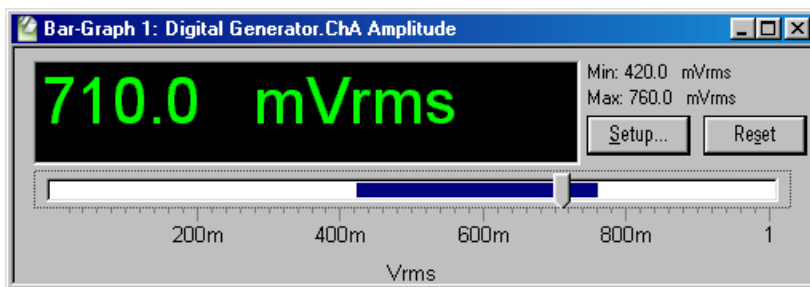

Figure 239. Typical Bar Graph for settings.

Bar Graph settings are displayed as green digits and also as a horizontal white bar with a slider control. Moving the slider along the bar will adjust the signal setting in real time, simulating an analog control. You can remove the slider bar display by selecting **Display Digits Only** on the Setup panel.

You can move the slider by dragging it with the mouse pointer, or, if the slider has been most recently selected, by using the left and right keyboard arrows.

The minimum setting step can be changed by entering a new value into the **Increment** field on the Bar Graph Setup panel.

When the slider has been moved, a blue horizontal bar will appear on the white bar to indicate the history of minimum and maximum settings. This can be reset by clicking the **Reset** button or the **Reset Min/Max** button on the Setup panel.

Chapter 18

Editing Data and Setting Limits

The Data Editor

Any data collected by the Sweep panel, including stimulus and response data from real-time sweeps, and bin centers and values in batch-mode measurements, is temporarily stored in memory during an ATS session. This data can be replaced, deleted, appended to, stored on disk, and so on. ATS data which has been stored on disk as an .atsa file or within a test can be loaded to become the current data in memory.

The Data Editor panel gives you a view of the current data in a table, much like a spreadsheet page. The Graph panel uses these values to draw the traces on the X-Y graph display; if you change a value in a Data Editor cell, the corresponding point on the graph will move.

Certain data will not graph, including a single point sweep, a sweep which contains changes of direction in **Source 1** values, or, in graphs where two unit domains already occupy the left and right Y-axes, another data set expressed in a third unit domain.

The Data Editor, however, shows all the data in current memory, even data which will not graph. If you have accidentally configured a sweep that will not graph, the Data Editor can verify whether or not the sweep has executed, and allows you to examine the data to find the error.

The Data Editor is closely tied to both the ATS Sweep and Graph functions, which are discussed in Chapter 15 and Chapter 16.

The Data Editor Panel

Figure 240. The Data Editor panel.

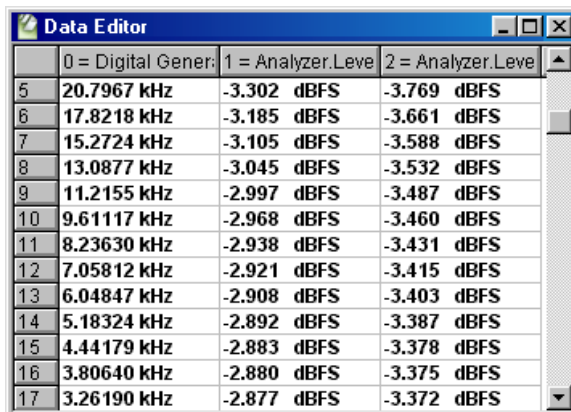

	0 = Digital Gener.	1 = Analyzer.Level	2 = Analyzer.Level
5	20.7967 kHz	-3.302 dBFS	-3.769 dBFS
6	17.8218 kHz	-3.185 dBFS	-3.661 dBFS
7	15.2724 kHz	-3.105 dBFS	-3.588 dBFS
8	13.0877 kHz	-3.045 dBFS	-3.532 dBFS
9	11.2155 kHz	-2.997 dBFS	-3.487 dBFS
10	9.61117 kHz	-2.968 dBFS	-3.460 dBFS
11	8.23630 kHz	-2.938 dBFS	-3.431 dBFS
12	7.05812 kHz	-2.921 dBFS	-3.415 dBFS
13	6.04847 kHz	-2.908 dBFS	-3.403 dBFS
14	5.18324 kHz	-2.892 dBFS	-3.387 dBFS
15	4.44179 kHz	-2.883 dBFS	-3.378 dBFS
16	3.80640 kHz	-2.880 dBFS	-3.375 dBFS
17	3.26190 kHz	-2.877 dBFS	-3.372 dBFS



The ATS Data Editor is available by selecting **Panels > Data Editor** from the Menu bar or by clicking the **Data Editor** icon on the toolbar.

Columns

Data Editor columns cannot be edited. You cannot add, delete, move or rename a Data Editor column. These columns correspond to the **Source** and **Data** settings in the Sweep panel; to add or remove a column you must reconfigure the sweep.

The column width can be adjusted by dragging the column header delimiters with the mouse pointer.

Rows

Data editor rows correspond to Sweep measurement points. You may add or remove Data Editor rows. Adding or removing rows changes the data in memory; the graph and stored data files will reflect your modifications.

Data

The settings and reading values shown in the Data Editor cells can also be edited. Editing the value in a cell changes the data in memory, and the graph and stored data files will reflect your modifications.

Data Display Typefaces

The displayed values in the cells can appear in a normal typeface, in a **bold** typeface, and, when limits are exceeded, in a red typeface.

The normal and **bold** typefaces alternate between sweeps (or changes in sweep direction) for easy identification of data sets when performing appended or nested sweeps. These normal/**bold** designations correspond to the normal/**bold** designations in the Graph Legend display.

The Data Editor will also scroll to the first data point in a trace when the row for that trace has been selected in the Graph Legend. Graph cursor locations are indicated in the Data Editor by highlighting the cursor cells with a light gray background.

See **Graph Legend / Data Editor Linkage**, page 296.

Data Display Flags

Data values may also be flagged with letters to indicate special conditions:

- **B** (Bad) indicates invalid data from Analyzer overload, an invalid Multitone reading, etc. Instead of a measured value, the Data Editor shows “-----”.
- **U** (Upper) indicates that the measurement value has exceeded the Upper limit. This condition is also marked by a red typeface. See **Limits** on page 310.
- **L** (Lower) indicates that the measurement value has passed below the Lower limit. This condition is also marked by a red typeface. See **Limits** on page 310.
- **T** (Timeout) indicates that settling has timed out for this measurement. See **Timeout** on page 283.
- **R** (Regulation) indicates that the attempt to regulate this data reading was unsuccessful. See **Regulation** on page 355.

Editing the Current Data in Memory

In the Data Editor window, you can enter or change data in any cell by selecting the cell with the mouse pointer and entering or deleting the value.

For other editing options, right click within the Data Editor window. The Data Editor menu will open and provide the following choices:

- **New Data**
New Data erases all the information in memory and cannot be undone.
- **Insert Row Before** inserts a row before the currently selected row.
- **Insert Row After** inserts a row after the currently selected row.

- **Add Row to the End** will add one row to an empty data table, or will add one row below the last existing row.
- **Delete Row** deletes the currently selected rows.
- **Select all rows**
- **Unselect all rows**

Saving ATS Data

The information in the Data Editor is saved on disk, along with other information, as part of an (.ats2) ATS test file. When a test is loaded, the test information becomes the current data and is viewable in the Data Editor.

The current data shown in the Data Editor can also be saved in several types of data-only files, which ATS uses for different purposes, as follows:

- Data (.atsa) file. Data files can be reloaded as current data.
- Limit (.atsl) file. Limit files can be attached to a sweep to provide upper and lower pass/fail limits against which to compare the current measurements. Limits are discussed below.
- Sweep (.atss) file. Sweep files are used to store data for Table Sweeps, which are sweeps that get their **Source** data from a table rather than Sweep panel settings. See **Table Sweeps**, page 270.
- EQ (.atsq) file. EQ files are used to modify sweep measurements by computing the sweep data against the data in an EQ table. See **Compute Equalize**, page 326.

Setting Limits

You may want to compare a graph of a DUT's performance with an ideal device or with a published standard. It is possible to append one graph to another and make a visual comparison, but ATS provides a more powerful technique: setting limits and performing a pass/fail test.

To set limits in ATS, you must attach a limit file to your sweep. See Chapter 15 for a detailed discussion of sweeps.

When a measured sweep value exceeds a set limit value, the measurement is flagged as having failed the limit. This flag can be viewed in the Data Editor or reported in more detail in the Log file. If your pass/fail test is part of an automated AP Basic macro, the flag can be reported, or it can be used as a trigger for some other command. A limit can also be configured to immediately stop the sweep on failure. See **Actions Upon Failure**, page 314.

Making a Limit File

Any ATS data which can be viewed in the Data Editor or saved as a data file can be a Limit File. This enables you to use actual measured data from a test on one DUT as the limits or standards for a test on a different DUT.

Instead, you may want to use published standards or arbitrary values as your limits. In these cases you can enter the data manually into the Data Editor, or edit an existing Limit File in the Attached File Editor, or create limit values in a spreadsheet or text editor program and import the file into ATS.

As an example, we will create a limit file in the Data Editor.

First set up a new sweep with two data traces. The default sweep starts with only one trace, **Data 1**; to add a second trace go to the **Data 3** browser and set it to **DSP Analyzer Level B**. Click **Single Point** and **Go**; this will inform the Data Editor that you are using two data columns.

Open the Data Editor. The display will have three column headings and one row of data, the single point sweep you just performed. Click the right mouse button to open the Data Editor menu, and add five more rows using the **Add Row to the End** command, repeated five times.

To enter a value, click the cursor in a cell and type. To make a complete trace, you must enter all the **Source** and **Data** values necessary to describe the limit you want. If the Graph panel is open, you can view the trace as you create it.

Create a limit trace by entering the values shown in Figure 241.

Figure 241. Creating a Limit Data in the Data Editor

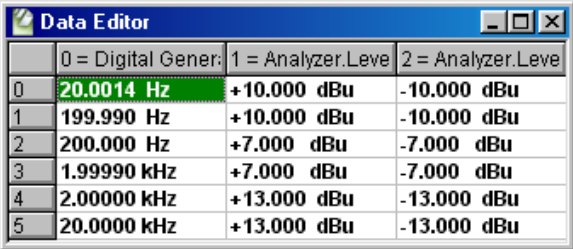

	0 = Digital Gener.	1 = Analyzer.Level	2 = Analyzer.Level
0	20.0014 Hz	+10.000 dBu	-10.000 dBu
1	199.990 Hz	+10.000 dBu	-10.000 dBu
2	200.000 Hz	+7.000 dBu	-7.000 dBu
3	1.99990 kHz	+7.000 dBu	-7.000 dBu
4	2.00000 kHz	+13.000 dBu	-13.000 dBu
5	20.0000 kHz	+13.000 dBu	-13.000 dBu

This will produce the limit traces shown in Figure 242.

Figure 242. Limit Traces shown on Graph.

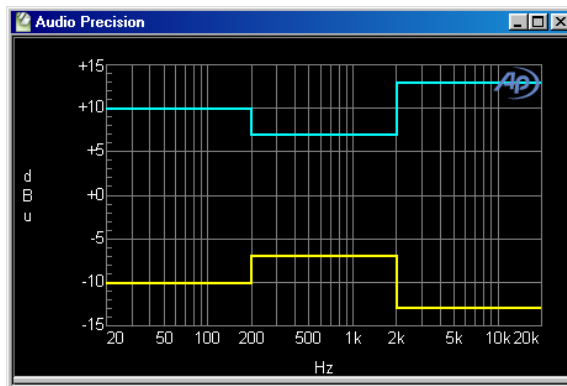

When you are satisfied with the limits you have created, save the data as an AP limit file using the command **File > Save As > Limit Data**.

When making a limit file, there are some constraints you must remember:

- The **Source 1** column of the limit data must correspond with the **Source 1** parameter of the sweep the file will be attached to. For example, a frequency-sweep test may have generator or FFT frequency as **Source 1**, and any limit files used with this test must also have frequency at **Source 1**.
- There must be a **Data** column heading for each limit.
- The units of measurement for each limit data column must be in the same unit domain as the corresponding data in the sweep the file will be attached to.

You can save upper and lower limits in two separate files; or, you can save upper and lower limits as two different data columns in the same file.

If two measurements are to be compared against exactly the same limits, as is often done in stereo sweeps, the same data column can be used as a limit for multiple measurements. If you have checked the **Stereo Sweep** checkbox on the Sweep panel, the limit attached to **Data 1** will also be attached to **Data 3**. See **Stereo Sweeps**, page 267.

Attaching a Limit File

Limits are attached to specific data traces on a sweep. To attach a limit file, choose the data in your sweep that you would like to compare to a limit (**Data 1**, for example) and click the **Limit** button for that **Data**.

The Limit File Attachment dialog box will appear. Browse to the data file that contains the limit data you would like to use. You can select any type

of AP data file, not just an “.atsl” Limit file, as the source of your limit values.

Figure 243. Limit File Attachment dialog box.

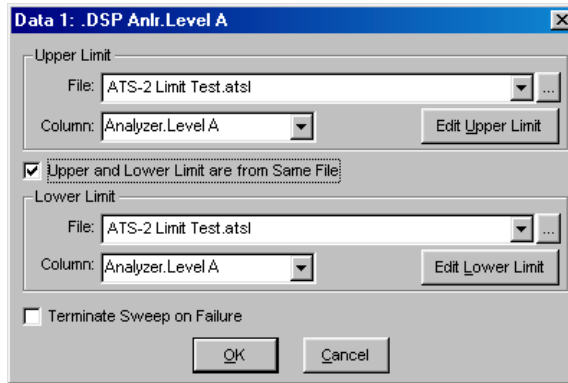

You can attach upper limits, lower limits, or both. Just select a data file in the appropriate area of the dialog box. Check the box labeled **Upper and Lower Limit are from same file** if you are using data from a single file for both upper and lower limits.

Once you attach a data file, a list of the available data columns in the file will be displayed in the list box under the file selection field. If there is more than one data column, you must indicate the column you would like to use as limit data for your sweep.

Using the Attached File Editor

Once a file is attached, you have the opportunity to edit the data in the file. Click on the **Edit Upper Limit** or **Edit Lower Limit** button to edit the attached file. The Attached File Editor will open.

Figure 244. The Attached File editor.

	Digital Generator	**Data 1/1 lowerlimit	Analyzer.Level A
0	20.0014 Hz	+10.000 dBu	-10.000 dBu
1	199.990 Hz	+10.000 dBu	-10.000 dBu
2	200.000 Hz	+7.000 dBu	-7.000 dBu
3	1.99990 kHz	+7.000 dBu	-7.000 dBu
4	2.00000 kHz	+13.000 dBu	-13.000 dBu
5	20.0000 kHz	+13.000 dBu	-13.000 dBu

The Attached File Editor is very similar in appearance to the Data Editor (page 307), but the two windows have different functions. The Data Editor displays the data in memory, while the Attached File Editor displays the data in the upper or lower attached file. The Attached File Editor is also available from the Table Sweep dialog box (see page 270) and the EQ Curve dialog box (see page 87).

You can view and edit the attached limit data in the Attached File Editor. In the Attached File Editor display, the column corresponding to the limit data you have selected is marked with two asterisks (**).

Changes you make in the attached file values will not be effective until you save the file. To save a file from the Attached File Editor, close the editor window. A dialog box will open and prompt you to save the file. The file is always saved under its current file name, overwriting the previously saved file.

*The commands on the File menu (**File > Save > Limit**, etc.) save the data in current memory, not the edited data in an attached file. Close the Attached File Editor to properly save this data.*

Actions Upon Failure

A pass/fail test fails when the measured data exceeds a limit value during a test. Depending upon the system settings and configuration, ATS will indicate a limit failure in several ways:

■ Terminate Sweep

Normally, the sweep will continue even if limits are exceeded. However, if you click the **Terminate Sweep on Failure** box on the Limit File Attachment dialog box, the sweep will end if a limit is exceeded.

■ Tabular Display Flags

Any measurement that exceeds a limit will be marked with a **U** (for upper) or an **L** (for lower) in the Data Editor table. See **Data Editor**, page 307.

■ Log File Indicators

If **Log Errors** is set in the Configuration panel, limit failures will be shown in detail, displaying **Source**, **Data** and **Limit** values and the amount and sign (+ or -) of the error for each limit failure. See **The Log File**, page 364.

More About Using AP Data Files

Data files include the four types listed on page 310. Data saved to any of these filetypes is maintained in an identical format; the extensions are different as an administrative aid to help you and the ATS software determine the intended purpose of a particular data file.

A consequence of this is that you can use an EQ file (.atsq) for a Table Sweep, or a Data file (.atsa) for setting limits.

This is particularly useful as it enables you to save all your data, including Sweep data, EQ and Limit data, in one file. You can then attach the file as a Sweep Table or Limit or EQ file and select the appropriate data column from the list within the file browser.

AP data files are binary files, and it is not possible to edit the files without using the Data Editor or the Attached File Editor. However, it is possible to export the current data in memory as an ASCII text file for use in a spreadsheet or text editor program. The ASCII file contains AP data file header information and the data in a comma-delimited format. The extension for the ASCII file is .atsx.

You can open the ASCII file in Microsoft Excel, for example, edit the data and save the file, and then re-import the file into ATS and save it once more in one of the native AP data file formats.

When editing the ASCII version of an AP data file in an external program, you must keep the correct column/row relationships and maintain or insert a correct file header at the top of your data. Here is an example of the information in the ASCII version of an AP data file:

```

untitled, 01/20/02 14:01:21
Digital Generator.Frequency, Analyzer.Level A, Analyzer.Level A, Analyzer.Level A, , , ,
Source 1, Data 1, Data 2, Data 3, , , ,
Hz, dBu, dBu, dBu, , , ,
20.001411438, 9.9999999713, 9.9999999713, -10.000000029, , , ,
199.99, 9.9999999713, 9.9999999713, -10.000000057, , , ,
200, 6.9999999713, 6.9999999713, -7.0000000287, , , ,
1999.9, 6.9999999426, 6.9999999426, -7.0000000574, , , ,
2000, 12.999999971, 12.999999971, -13.000000029, , , ,
20000, 12.999999943, 12.999999943, -13.000000057, , , ,

```

Figure 245. ASCII version of an AP data file.

Chapter 19

Performing Computations on Data

Chapters 15, 16 and 18 explain how ATS-2 can gather, display, edit and perform other operations on a set of data. Using the commands on the Compute menu, you can also process the current data in memory with a number of mathematical algorithms.

Use of the Compute algorithms does not change the acquisition of data. Instead, the acquired data points are changed according to the applied algorithms by averaging, for example, or inversion or normalization.

*The Compute algorithms irrevocably change the data in memory. Save the original data on disk if you wish to keep it. See **Comparing Computed Results with Original Data**, page 327.*

ATS provides 10 different computations which you can apply to your data as selections on the Compute menu, as shown in Figure 246.

Figure 246. Compute menu commands.

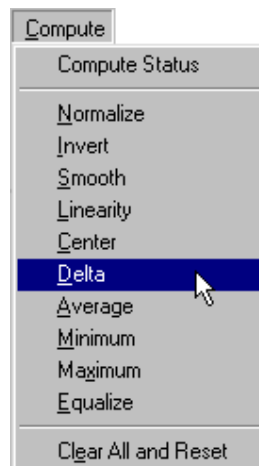

Additionally, the menu provides a **Compute Status** command, which opens a dialog box to view and edit the list created by applying the **Apply After Sweep** option to one or more Compute algorithms. At the bottom of the menu is the **Clear All and Reset** command.

These commands are discussed on page 326.

The Compute Dialog Boxes

Although each of the 10 Compute dialog boxes has different features associated with a particular compute algorithm, all the boxes are similar and have the following checkboxes and buttons in common:

Figure 247. Compute dialog box common features.

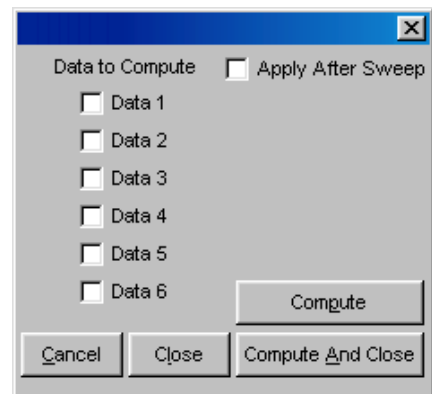

Each Compute dialog box has a list of six checkboxes labeled **Data 1** through **Data 6**. The Compute algorithms will only operate on the data trace or traces you have selected, leaving the other data untouched.

You can select different combinations of data traces in different Compute algorithm dialog boxes.

Four buttons give you the following commands:

- **Cancel**
Abort the operation.
- **Close**
Keep the settings made and close the dialog box.
- **Compute**
Perform the computation while leaving the dialog box open for further operations.
- **Compute and Close**
Keep the settings, perform the computation and close the dialog box.

It is possible to perform a Compute operation repeatedly, or to perform several different compute operations in sequence. You can do this manually by opening and configuring Compute dialog boxes and clicking the **Compute** button.

It is also possible to construct a series of computations which will be performed on the data automatically at the end of the sweep. Checking the **Apply After Sweep** checkbox in a Compute dialog box and then clicking **Close** will place that computation in a list which will be executed after the sweep is completed. The order in which the computations are listed and executed is determined by the order in which you set and close the various compute functions. This list can be viewed and edited in the Compute Status dialog box, page 326.

Compute: Normalize

Compute: Normalize allows you to move a trace up or down against the Y-axis or “normalize” the data in relation to a new value. For example, you may have made a frequency response sweep at some arbitrary level, but now wish to display the trace in relation to a 0 dBr A reference at the mid-frequencies.

As another example, you could make a sweep of a “golden unit” to get a reference response, and then normalize the trace 3 dB above and then again 3 dB below a nominal zero level. These upper and lower traces could be saved in a Limit file as upper and lower limits for subsequent tests of other units.

Figure 248. Compute Normalize Dialog Box.

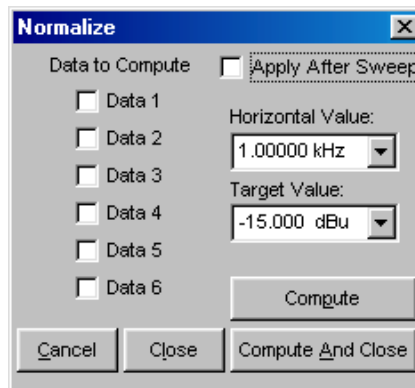

To normalize a trace, you must select the horizontal (X-axis) value of the data point you want to be the normalized reference, and then enter the Y-axis value you want as a “target value.” In the case of the “golden unit” to make an upper limit you might choose 1 kHz as the **Horizontal Value** and +3 dB as the **Target Value**.

You may normalize more than one trace to the same **Target Value** by checking the appropriate **Data** checkboxes. However, all the traces selected must be of the same unit domain as the **Target Value**.

Compute: Invert

Compute: Invert turns a curve “upside down.” Specifically, Compute: Invert reciprocates data expressed in linear units, and negates data expressed in decibel units.

A typical application is to invert a measured frequency response and save the inverted trace as an EQ file, which can then be attached to a sweep to correct for system response variations.

Figure 249. Compute Invert Dialog Box.

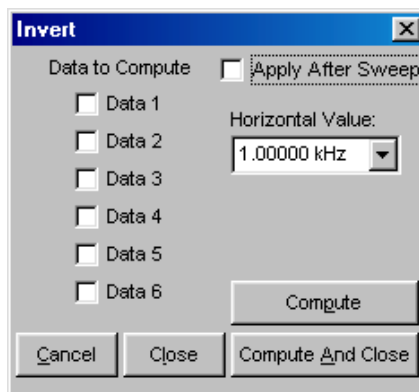

To invert a trace, first decide what the “pivot point” of your inversion should be; that is, which data point you would like to remain constant when the trace is flipped. Enter the X-axis value of that data point in the **Horizontal Value** field. The trace inversion will be performed around this point when the data is computed.

Compute: Smooth

Compute: Smooth “smooths out” a trace by assigning each data point a new value, which is the value of the average of that point and the two points on either side of it.

Figure 250. Compute Smooth Dialog Box.

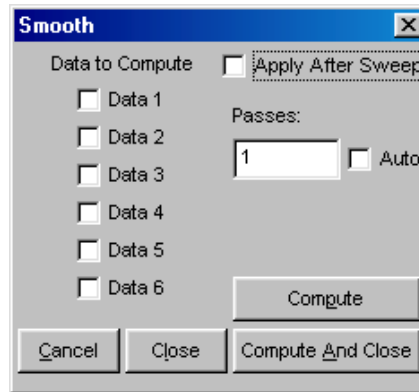

The data can be passed through this process repeatedly, with each pass increasing the smoothing. The default number of passes is **1**; you can specify a greater number of passes by entering a higher number in the **Passes** field. If the **Auto** box is checked, the **Passes** field will not be available for entry and ATS will automatically select a number of passes based on the number of measurement points in the data; specifically, if **Auto** is checked, the number of passes is the integer nearest $(1/2) \times \sqrt{\text{number of points}}$, but is never fewer than 3.

Smoothing is useful when you suspect some of the more extreme data points are spurious. Loudspeaker measurements, for example, often show large peaks and dips which are often attributed to room reflections rather than speaker response. Smoothing out such a trace may provide a more useful view of the speaker response.

Compute: Linearity

Compute: Linearity graphically displays the variance of each of the measurement data points from a linear response across all the data.

In the first of two mathematical operations, the best straight line is fitted to the data, across a range you can specify. This line is computed using the *least squares* method.

Next, the value of every data point is subtracted from this straight line; the result is a graph of deviation from perfect linearity. This is useful to evaluate input-output amplitude linearity of an ADC or DAC; or of the input-output phase shift of a loudspeaker, for example.

Figure 251. Compute Linearity Dialog Box.

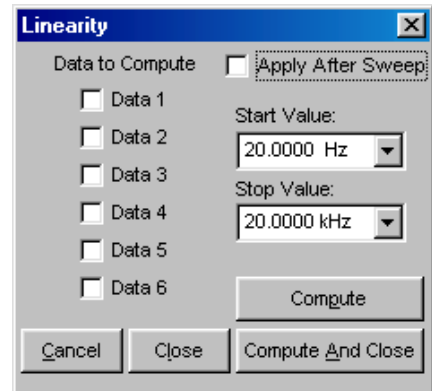

Typically, a DUT will have its greatest nonlinearity at the measurement extremes. To keep this atypical data from affecting the initial straight-line fitting, you can enter values in the **Start Value** and **Stop Value** fields to limit the range of data examined. These values only limit the straight-line computation; after the line is derived, every data point in the trace is subtracted from the line value.

Since the values of the data linearity deviations are often small, you may want to optimize the graph view for better resolution. See **Optimize**, page 288.

Compute: Center

Compute: Center can only be used with data sets that have both upper and lower limit files attached. See **Limits**, page 310.

Compute: Center moves the data trace to center it evenly between the upper and lower limits. This is useful in situations where the shape of the curve and its general agreement with the limits are more important considerations than the absolute amplitude of its data points.

Figure 252. Compute Center Dialog Box

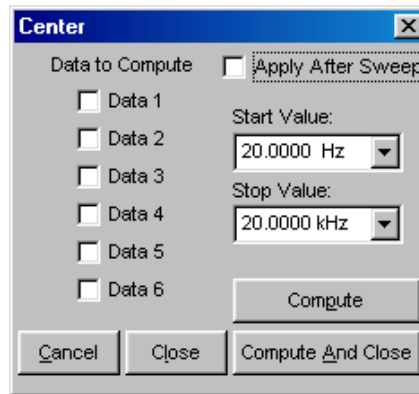

For example, in comparing microphones an evaluation of the overall microphone response as compared to limits is often more important than focusing on any minor level differences which may exist.

To keep data from the measurement extremes from skewing the centering process, you can enter values in the **Start Value** and **Stop Value** fields to limit the range of data examined. These values only limit the centering computation; every data point in the trace is moved together.

When the data is compared to limits for a Pass/Fail test, all the data specified in the data files are used to make the Pass/Fail decisions. See **Limits**, page 310.

Compute: Delta

Compute: Delta calculates the difference, or delta, between two sets of data. ATS can do this in two different ways:

- by subtracting the data in a specified data file from the current data in memory; or
- by subtracting the data in one column (data trace) of the current data in memory from another column of the current data in memory.

With **Compute: Delta** you can shift your data by an offset, using a constant saved in a file, for example; or subtract one channel of a stereo signal from the other, to measure interchannel differences. If you first normalize your trace at 0 dBV or 1 V at the pivot point, you can use **Compute: Delta** to apply an EQ curve to your measurement after the fact. See **Compute: Equalize**, below.

Figure 253. Compute Delta Dialog Box

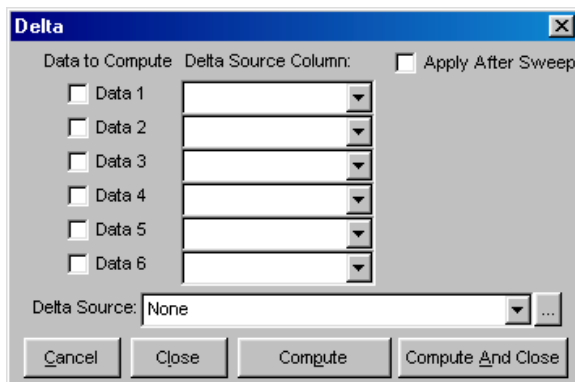

First select the **Delta Source**; that is, the data to be subtracted from the current data in memory. The list under **Delta Source** initially contains two choices: **None** and **SweepData**.

If you want to perform a **Delta** computation on two data traces of the current data in memory, select **SweepData**.

To use a data file, click the browser button and navigate to the file.

In either case, once you have selected a **Delta Source** you must then choose a data trace in current memory, and the **Delta Source** data column you wish to subtract from it.

Compute: Average

Compute: Average calculates the average value for all the data points within the range you specify in the **Start Value** and **Stop Value** fields. All the values for the entire data set will be replaced with this computed average, including data points which may be outside the range you set for calculating the average.

Figure 254. Compute Average Dialog Box

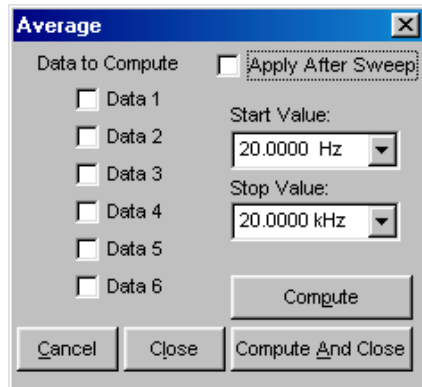

Compute: Minimum

Compute: Minimum will find the minimum value in a data set, examining all the data points within the range you specify in the **Start Value** and **Stop Value** fields. All the values for the entire data set will be replaced with this minimum value, including data points which may be outside the range you set for examining the data.

Figure 255. Compute Minimum Dialog Box

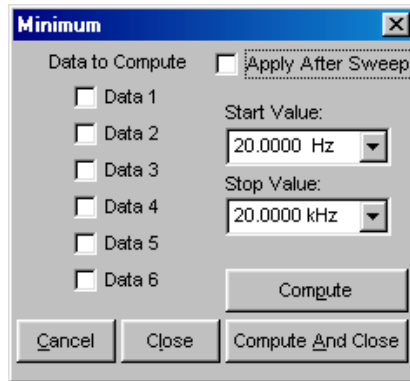

Compute: Maximum

Compute: Maximum will find the maximum value in a data set, examining all the data points within the range you specify in the **Start Value** and **Stop Value** fields. All the values for the entire data set will be replaced with this maximum value, including data points which may be outside the range you set for examining the data.

Figure 256. Compute Maximum Dialog Box

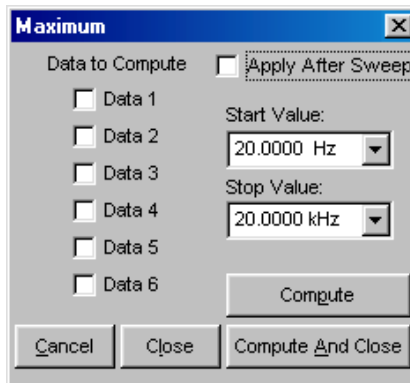

Compute: Equalize

Compute: Equalize shifts the value of each point in the selected data set by the value at the corresponding point in the **EQ Source** data set. This gives a result similar to attaching an EQ file to the Analog or Digital Generator (see **Attaching an EQ Curve**, page 87); however, the **Compute: Equalize** technique allows you to apply an EQ curve to your measurement after the fact, rather than equalizing the swept tone.

Figure 257. Compute Equalize Dialog Box

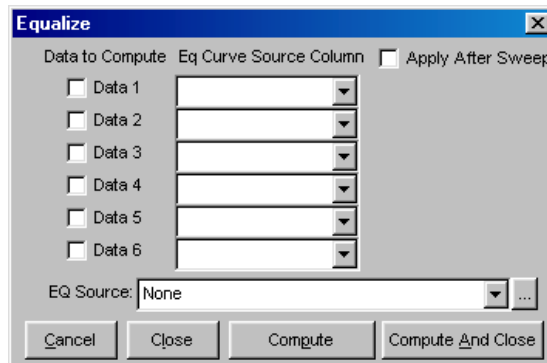

Compute: Equalize can use either a data column from an attached EQ file or a data column from the current data in memory as an EQ source.

Select the **EQ Source** using the browser in the **Compute: Equalize** dialog box. The list under **EQ Source** initially contains two choices: **None** and **SweepData**. To use a data file, click the browser button and navigate to the file.

If you want use data from another column of the current data in memory, select **SweepData** from the **EQ Source** list.

In either case, once you have chosen a **EQ Source**, you must then select which data trace in current memory and which data column from the **EQ Source** you wish to use.

Compute: Equalize interpolates between data points in the **EQ Source** data as necessary to produce Y-axis values precisely at the specified X-axis values.

Compute Status

The **Compute Status** command on the Compute menu brings up the Compute after Sweep Status panel, which lists all the Compute operations you have selected to **Apply After Sweep**.

The list shows the order in which the computations will be performed. This initial order is determined by the order in which you have set up and enabled Compute operations and set them to **Apply After Sweep**.

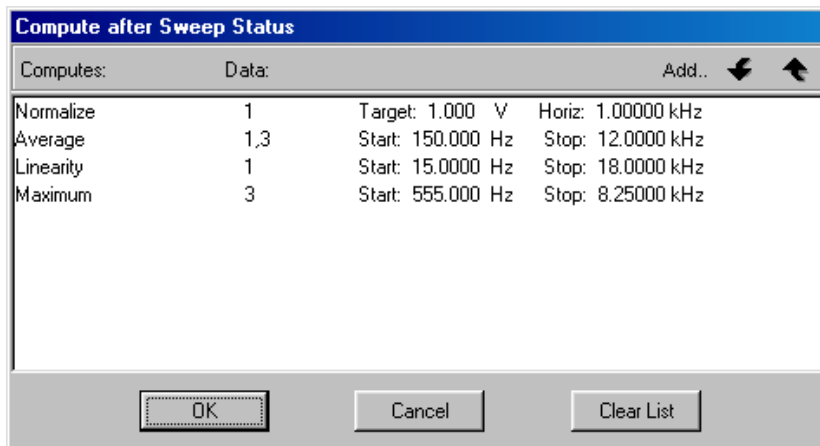

Figure 258. Compute Status Dialog Box.

You can add new Compute operations to the list, change the order of the computations, and clear the entire list.

Note that the Compute After Sweep Status list shows only those Compute operations which have their **Compute After Sweep** checkbox checked. Adding a Compute operation from within the list sets the checkbox in the specified operation panel. Clicking the **Clear List** button does not clear all your Compute settings, but simply unchecks the **Compute After Sweep** checkbox in every Compute panel.

Click **Add** to put a new Compute operation on the list.

To change the sequence of computations, select a Compute operation on the list and click the up or down arrow to move that operation.

Clear All and Reset

The **Clear All and Reset** command at the bottom of the Compute menu clears all existing settings on every Compute panel.

Comparing Results with Original Data

The Compute operations actually change the current data in memory, applying the computations you have selected to the data points you have chosen. If you will need your original data again, be sure to save it before you apply a Compute operation.

Since the data in memory is changed after a Compute operation, a comparison between the original data and the computed result requires that certain steps be taken before the Compute operation is performed.

One easy way to view both the original data and the computed result is to duplicate the original data in a unused data column, for reference purposes. Do this by setting both **Data 1** and **Data 3** to the same instrument and channel, for example, before sweeping. When your sweep is completed you will have the same values in two columns in the Data Editor.

Now, if you perform your computation on **Data 1**, you can view it against **Data 3**, which displays the reference duplicate of the original data.

Chapter 20

Printing and Exporting

ATS graphs can be printed to any Windows-compatible printer in black-and-white or in color. As an option, the underlying data can be also printed as a table.

ATS graphs can be copied to the Windows Clipboard as well, in either bitmap or vector graphics format. Graphs can also be directly exported as a Windows Metafile or Enhanced Metafile.

ATS panels can be captured as bitmapped “screen shots” by the **Edit > Copy Panel to Clipboard** command on the Edit menu. Once the panel is on the Windows clipboard, it can be pasted into a word processing program such as Microsoft Word or into one of many “paint” or “draw” graphics programs for editing or printing.

Printing ATS Graphs

When printing an ATS graph, the key information shown on the graph panel is carried through unchanged to the printed page. This information includes:

- the parameters to be graphed; and
- X-axis and left and right Y-axis calibrations and scaling.

This information cannot be changed from the print menus.

However, display aspects of the graph can be made independent of the graph, and elements such as trace visibility, color and line style, graph labeling and legend, graticule visibility and so on can be modified at print time. These changes are made on the Page Setup panel.

Page Setup

The Page Setup panel is available by the menu choice **File > Page Setup**. The page settings you make are saved when you save your work as an ATS test file, along with the current data and the various instrument panel settings also included in a test file.

Figure 259. Page Setup panel, **Display** page.

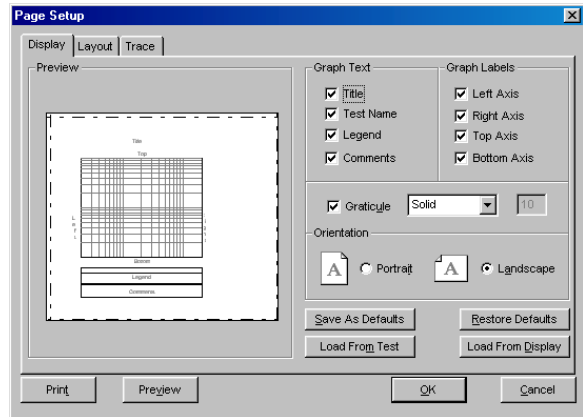

The Page Setup panel has three tabs. On the **Display** page, shown in Figure 259, you can select the page orientation, the text and labels to be included, and how the graticule lines are to be printed.

Figure 260. Page Setup panel, **Layout** page.

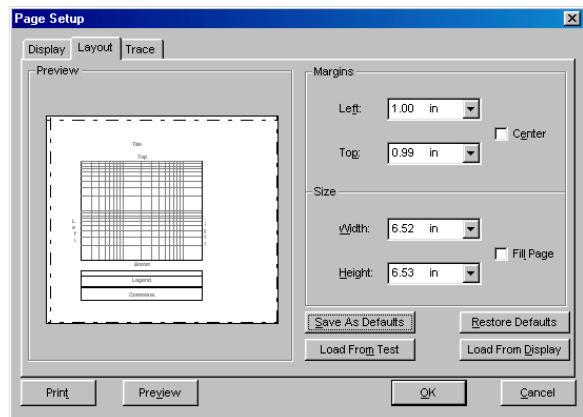

Figure 260 shows the **Layout** page, where you can set margins, center the graph on the page or resize the graph to fill the page.

You can set margins either by entering numbers in the margin boxes or by dragging the page margins (shown as dotted lines) on the preview panel with the mouse pointer.

To resize the graph, drag the corner of the graph with the mouse pointer. To move the graph on the page, set the mouse pointer within the graph and drag the graph to a new location.

The **Center** and **Fill Page** checkboxes override any existing or manually set size and position adjustments.

On both the **Display** and **Layout** pages you have the option of saving your settings as new default settings. You can also reset your page settings by restoring these defaults, by loading the settings from the current graph screen display, or by loading the page settings from a previously saved ATS test file.

Figure 261. Page Setup panel, Trace page.

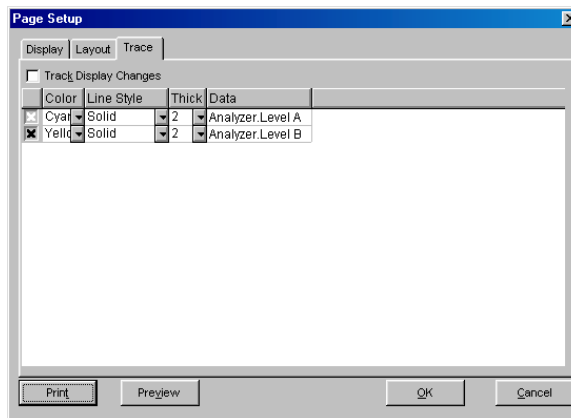

The **Trace** page, shown in Figure 261, gives you the ability to choose which traces will be visible in the printed graph. An “X” on a trace row selects that trace to be visible. You can also specify trace color, line style and thickness.

If you check the **Track Display Changes** checkbox, the trace settings on this page will be unavailable, and instead the printer trace settings will be set to the trace settings on the screen display graph.

Print Setup

Click **File > Print Setup** to change your printer or access your printer’s configuration settings. You can also do this from the **Print** dialog box.

Printing a Graph

Click **File > Print > Graph** to send an ATS graph to the printer. If you have not yet set up your page layout, you should first go to **File > Page Setup** (see page 330).

The Print dialog box will appear. Click **OK** to print the graph, or first set other parameters such as number of pages, page range, printer selection and setup and so on.

Print Preview

Click **File > Print Preview** to view an on-screen preview of your printed page. You can zoom to different magnifications by clicking the Zoom buttons or by clicking the mouse pointer on the preview page.

Figure 262. Print Preview.

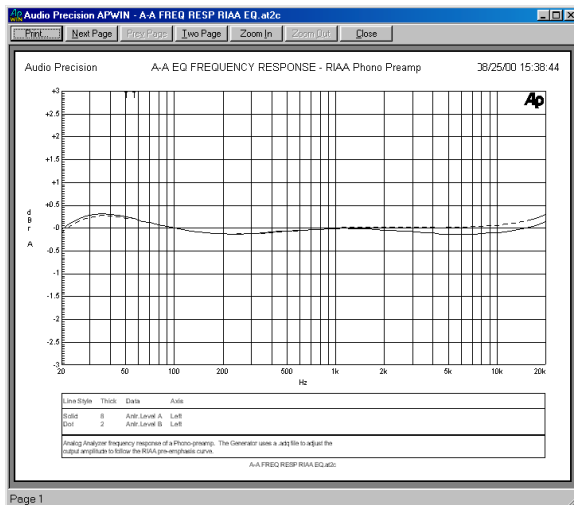

Printing ATS Data as a Table

You also have the option of printing the ATS data in a tabular format. Click **File > Print > Data**. The Data Editor will appear, followed by the Print dialog box. Click **Print** to print the table.

Audio Precision 07/08/02 14:41:53 File Name: untitled

	Digital Generator Frequency	Analyzer Level A	Analyzer Level B		Analyzer Level B
0	20.0000 Hz	+10.000 dBu	-10.000 dBu		
1	199.990 Hz	+10.000 dBu	-10.000 dBu		
2	200.000 Hz	+7.000 dBu	-7.000 dBu		
3	1.99990 kHz	+7.000 dBu	-7.000 dBu		
4	2.00000 kHz	+13.000 dBu	-13.000 dBu		
5	20.0000 kHz	+13.000 dBu	-13.000 dBu		

COMMENTS:

Figure 263. Printing ATS Data in a tabular format.

Printing to a File

You have the option of routing your print job to an HPGL or Postscript file rather than to your printer.

Click **Print to File**. A file browser dialog box will open.

Figure 264. Print to File Browser.

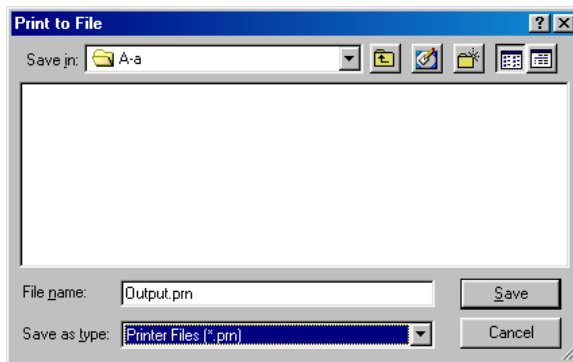

The type of file which will be created depends on the printer driver software which you have chosen. For example, if you have a Postscript laser printer selected in your Print Setup and then click **Print to File**, the file you create will be a Postscript file.

Postscript and HPGL files can be saved and later directly outputted to a printer. Additionally, many word processing and graphics programs will import HPGL and Postscript print files.

A Postscript file can also be converted to an Adobe Acrobat PDF file using the Adobe utility Acrobat Distiller®.

Exporting a Graph

An ATS graph can be exported as a vector graphics file, which can then be imported by a graphics software “draw” program for editing and printing. ATS will export vector graphics files in the Enhanced Metafile (*.emf) format.

Figure 265. Export Graph Browser.

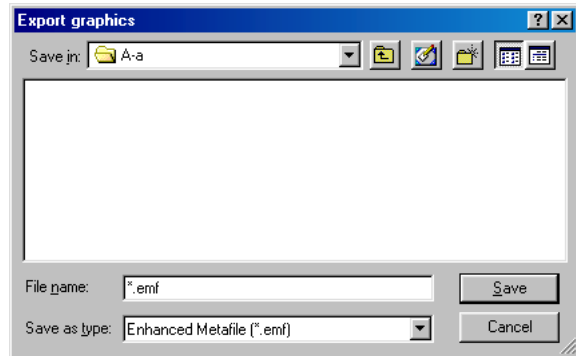

From the Menu bar, choose **File > Export > Graphics** to export a graph as a metafile.

Copying a Graph to the Clipboard

To copy an ATS graph to the Windows Clipboard, use the command **Edit > Copy Panel to Clipboard**.

This command can copy the graph to the clipboard as either a bitmap or as a metafile vector graphic image. To make this choice, you must first set your preference on the **Graph** tab in the ATS Configuration panel at **Utilities > Configuration**, which is discussed in Chapter 25.

The images captured in this way can be viewed and saved using Microsoft Clipboard Viewer, or the contents of the Clipboard can be pasted into word processing or graphics documents.

Copying a Window or Screen to the Clipboard

Microsoft Windows provides keyboard shortcuts for copying the entire screen or a selected window to the Windows Clipboard as a bitmap image.

To copy the entire screen to the Clipboard, press **Print Scrn**. To copy the active window to the Clipboard, press **Alt+Print Scrn**. Third-party screen capture programs will enable you to copy other screen areas to the clipboard.

The bitmaps captured in this way can be viewed and saved using Microsoft Clipboard Viewer, or the contents of the Clipboard can be pasted into word processing or graphics documents.

Bitmaps and Vector Graphics

*A bitmap graphics file is a bit-by-bit image of the graph displayed on the ATS graph panel. The resolution of a bitmap is set at its creation, and magnifying the image will reveal the individual pixels comprising the image. Bitmap files can be edited with “paint” graphics software. An ATS bitmap graph looks like the screen image, showing the graph as white and colored lines on a black background. Files with the filename extension *.bmp are bitmap files.*

*A vector graphics file describes the image in programming code, and such an image can be resized with no degradation. The resolution of a printed vector graphics file is dependent only on the resolution of the printer. Vector graphics files are edited with “draw” graphics software, and are usually easier to modify than bitmap files. An ATS vector graphics image shows the graph as black and colored lines on a white background. A graphic with the filename extension *.emf is a vector graphic file.*

Chapter 21

Monitoring

Headphone/Speaker Monitoring

ATS-2 has an internal speaker and a rear-panel headphone jack for monitoring of audio signals at different points in the system.

The speaker and the headphone jack carry a monaural signal, selected from the list on the Headphone/Speaker panel.

The headphone jack is a standard 3.5 mm tip-ring-sleeve (TRS) jack wired to apply the monaural signal to both the left and right sides of ordinary stereo headphones. When a plug is inserted into the headphone jack, the internal speaker is disconnected.

The Volume Bar



Figure 266. The Volume Bar.

The headphone output and the internal speaker share a common volume control and mute switch, which are available on both the Volume Bar and on the Headphone/Speaker panel, discussed below.

The Volume Bar is a toolbar that is enabled on the View menu. By default the Volume Bar is visible, and it will appear on every Workspace page. Like the other ATS toolbars, the Volume Bar can be attached at the top of the Workspace or can be dragged to float at any location in the page.

Drag the **Volume** slider with the mouse pointer to change volume. When the slider is selected, the left-right arrow keys will also adjust the volume.

Put a check in the **Mute** box to turn off the Headphone/Speaker outputs.

Headphone/Speaker panel

Figure 267. The Headphone/Speaker panel.

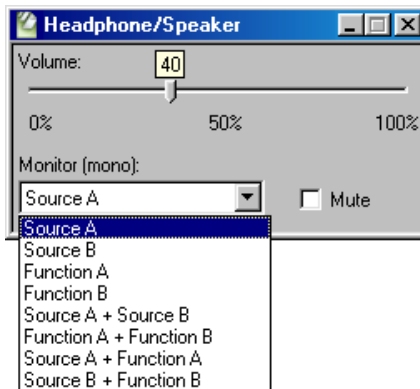

The Headphone/Speaker panel is available at **Panels > Headphone/Speaker** or by clicking the **Headphone/Speaker** button on the Panels toolbar.

The Headphone/Speaker panel repeats the **Volume** slider and **Mute** switch. These are the same controls that are on the Volume Bar, and the indicators on the two displays track each other.

Below the **Volume** slider is the **Monitor** list, which makes several audible monitor source choices available:

- **Source A**

This is the audio signal as it appears at the input to the Analyzer instrument in use, after ranging—the point where the Channel A **Level** or **Peak** meter readings are taken. If the Digital Interface Analyzer is the instrument, the monitored signal is the Channel A embedded audio.

Source A is the same signal that is at the **MONITOR OUTPUTS: SOURCE A** rear-panel BNC connection.

- **Source B**

This is the audio signal as it appears at the input to the Analyzer instrument in use, after ranging—the point where the Channel B **Level** or **Peak** meter readings are taken. If the Digital Interface Analyzer is the instrument, the monitored signal is the Channel B

embedded audio.

Source B is the same signal that is at the **MONITOR OUTPUTS: SOURCE B** rear-panel BNC connection.

- **Function A**

The channel A signal as it appears after a given **Audio Analyzer** function is applied. This is the same point as the **MONITOR OUTPUTS: FUNCTION A** rear-panel BNC.

Signal is only available at this point when using the **Audio Analyzer** instrument.

- **Function B**

The channel B signal as it appears after a given **Audio Analyzer** function is applied. This is the same point as the **MONITOR OUTPUTS: FUNCTION B** rear-panel BNC.

Signal is only available at this point when using the **Audio Analyzer** instrument.

- **Source A + Source B**

The sum of these signals.

- **Function A + Function B**

The sum of these signals.

- **Source A + Function A**

The sum of these signals.

- **Source B + Function B**

The sum of these signals.

The Monitor Outputs

Figure 268. The **MONITOR OUTPUTS** connections.

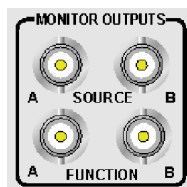

There are four **MONITOR OUTPUTS** available on BNC connectors on the ATS-2 rear panel. These are unbalanced outputs with a voltage range up to 4 V_{pp} and a source impedance of 422 Ω.

The **MONITOR OUTPUTS** are intended for oscilloscope or other monitoring. These outputs are not calibrated and should not be used for measurements.

The SOURCE Outputs

The **SOURCE A** and **SOURCE B** outputs carry the audio signals as they appear at the inputs to the Analyzer instrument in use, after ranging—the point where the **Level** or **Peak** meter readings are taken. If the Digital Interface Analyzer is the instrument, the monitored signals are the embedded audio.

The **SOURCE** monitor outputs are the same signals as can be selected on the **Headphone/Speaker** panel **Monitor: Source** selections.

The FUNCTION Outputs

The **FUNCTION A** and **FUNCTION B** outputs carry the audio signals as they appear after a given **Audio Analyzer** function is applied. The **FUNCTION** monitor outputs are the same signals as can be selected on the **Headphone/Speaker** panel **Monitor: Function** selections.

Signal is only available at the **FUNCTION** monitor outputs when using the **Audio Analyzer** instrument.

Chapter 22

Sync/Ref, Trigger and Aux

In addition to the main analog and digital signal connections on the front panel, ATS-2 provides a number of utility connections on the rear panel. These include the the **MONITOR OUTPUT** connectors, which are discussed in Chapter 21, and the APIB connector (and GPIB connector, if so configured) which are discussed in *Getting Started with ATS-2*.

In this chapter we will look at the remaining connections:

- **SYNC/REF IN**
- **TRIG IN**
- **TRIG OUT**
- **AUXILIARY CONTROL OUTPUT**
- **AUXILIARY CONTROL INPUT**

SYNC/REF IN

The **SYNC/REF IN** BNC connection and the Sync/Ref Input panel provide the ability to synchronize ATS-2's master clock to several types of external reference signals, including the sample rate or the frame rate of an AES3 or IEC60958 reference signal, the horizontal sync frequency of NTSC, PAL, or SECAM analog video signals, or to a squarewave or other periodic signal.

The master clock controls ATS-2's internal sample rate and is the reference for all ATS-2 frequency measurements. Synchronizing the master clock to an external reference is often necessary when making measurements in an installation where "house sync" is used.

An AES3 or IEC60958 digital audio signal applied to the **SYNC/REF IN** connector can also be used as the Pass Thru signal available to the two

signal generators. This feature enables you to use an external signal as the generator “waveform.” See **Wfm: Special: Pass Thru** on page 93 for the Analog Generator or page 116 for the Digital Generator.

Sync/Ref Input Panel

Figure 269. The Sync/Ref Input panel.

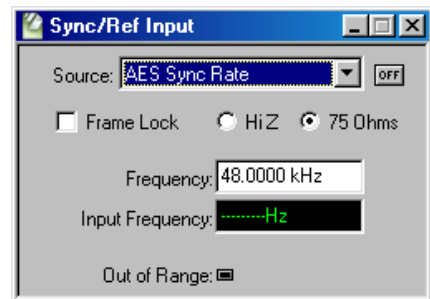

Two settings are required to synchronize ATS-2’s master clock to an external source:

- Select the format of the external sync signal in the **Source** field.
- Enter the exact nominal frequency of the external sync signal in the **Frequency** field.

In addition to these settings, the Sync/Ref Input panel enables you to set termination impedance options, and select the **Frame Lock** option for digital audio reference signals. There is also an **Input Frequency** display field and an **Out of Range** indicator to provide you with more information as you make the synchronization settings. A master **ON/OFF** button allows you to enable and disable synchronization. These settings and displays are discussed in detail below.

Reference Input Source

Figure 270. The Reference Input Source list.

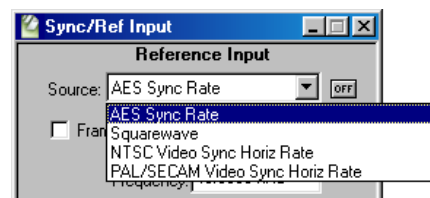

Select the format of the external synchronization signal from the **Source** list.

- **AES Sync Rate**

This selection will synchronize the ATS-2 master clock to the sample rate of a properly formatted AES3 or IEC60958 signal applied to the **SYNC/REF IN BNC**.

This choice synchronizes the sample rates, but does not ensure that the signal frames are aligned in time. To align the frames, the ATS-2 digital output signal must be set to the same sample rate as the reference signal and the **Frame Lock** box on the Sync/Ref Input panel must be checked.

- **Squarewave**

This selection will synchronize the ATS-2 master clock to a TTL squarewave signal or other periodic signal applied to the **SYNC/REF IN BNC**. This signal may be between 8 kHz to 10 MHz.

A bit clock output from a digital device applied to the **SYNC/REF IN** connection in Squarewave mode will synchronize the ATS-2 sample rate to the device sample rate. See **Squarewave frequency ranging**, below.

- **NTSC Video Sync Horiz Rate**

This selection will synchronize the ATS-2 master clock to the horizontal sync pulse (nominally 15.7343 kHz) of an NTSC analog video signal applied to the **SYNC/REF IN BNC**.

- **PAL/SECAM Video Sync Horiz Rate**

This selection will synchronize the ATS-2 master clock to the horizontal sync pulse (nominally 15.6250 kHz) of a PAL/SECAM analog video signal applied to the **SYNC/REF IN BNC**.

Squarewave frequency ranging

To cover the wide frequency range, ATS-2 performs automatic frequency range switching when **Squarewave** is selected as the Sync/Ref input source.

Due to this ranging, the measured input frequency reading can be in error if the input frequency differs by a large amount from the nominal frequency entered on the Sync/Ref panel. Enter a nominal frequency close to the actual input frequency.

If you do not know the squarewave input frequency, enter a nominal frequency of **8 kHz**. The measured frequency will then display correctly, although with slightly reduced accuracy. Now enter this displayed frequency as the nominal frequency, and the measured frequency will display correctly, with full accuracy.

Frame Lock

As discussed above, synchronization of AES3 or IEC60958 rates alone does not time-align the interface signal frames. Each AES3 or IEC60958 frame begins with a preamble pattern, and in time-aligned or frame-locked signals the X, Y and Z preambles start at the same moment.

When using **AES Sync Rate** for synchronization in ATS-2, checking **Frame Lock** time-aligns the frames as well. The ATS-2 digital output signal must be set to the same sample rate as the reference input signal for frame lock.

Input Termination Impedance

Set the termination impedance to **75 Ω** (or *terminated*) if ATS-2 is the only device connected to the reference source, or if it is the last device in a chain of devices. If ATS-2 is in a chain of devices but is not the last device in the chain, set the impedance to **HiZ** (or *bridging*).

Frequency

Set the exact nominal frequency of the synchronization signal in this field. For an AES3 signal, for example, it might be 44.100 kHz or 48.000 kHz. For a squarewave, set **Frequency** to the rate of the external clock.

If the actual reference signal is slightly different (less than 15 PPM) from the value entered here, synchronization will be achieved but all ATS-2 sample rates and readings will reflect the difference. If the value entered is more than 15 PPM away from the actual reference signal frequency, the internal crystal oscillator may not lock to the reference.

ATS automatically enters the two video sync rates for you. These may be changed by entering a new rate, if necessary.

Input Frequency

When a suitable reference signal is present at the **SYNC/REF IN BNC** for the selected **Source** format, the **Input Frequency** field will display that signal's frequency. This display aids in verifying the presence or absence of a sync signal and in determining the nominal frequency before synchronization is achieved.

Once ATS-2 has synchronized to the reference, the **Input Frequency** field is grayed out, since the measured frequency would be identical to **Frequency** setting.

Out of Range Indicator

The **Out of Range** indicator on the Sync/Ref Input panel is lighted if the actual reference signal frequency is outside ± 15 PPM of the value programmed in the **Frequency** entry field on the Sync/Ref panel, or outside the amplitude range required for reliable operation. The indicator may require several seconds to indicate an out of range condition.

TRIG IN

The **TRIG IN** BNC provides an input for triggering data acquisitions in batch-mode Analyzer instruments: the Spectrum Analyzer, the Multitone Audio Analyzer and the Digital Interface Analyzer.

The TRIG IN input will accept standard 3 V or 5 V TTL/CMOS logic signals. ATS instruments normally trigger on the rising edge of the signal transition, although option switches on each instrument panel enable inversion of the trigger function.

TRIG OUT and the Main Trigger Panel

Figure 271. The Main Trigger panel.

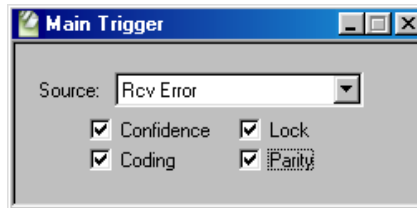

The ATS-2 trigger output signal appears at the **TRIG OUT** BNC connector on the rear panel. This signal is intended to trigger an oscilloscope or other monitoring device at the occurrence of a specific condition in the course of measurement.

The source for the trigger output signal is selected on the Main Trigger panel. These selections are identical to the trigger choices on the Digital Interface Analyzer panel (see page 209). Both panels control the same functions interactively.

The Trigger Output is a 5 V TTL/CMOS logic signal with a 50 Ω source impedance. The rising edge of the trigger output signal corresponds to the trigger event.

Figure 272. The Main Trigger source list.

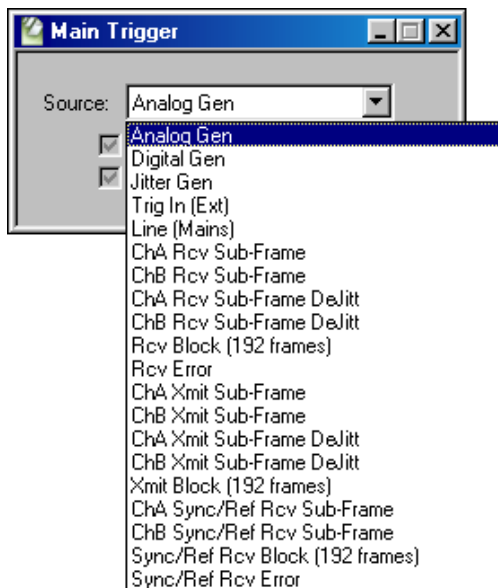

The Trigger Output sources are:

- **Analog Gen**

A trigger transition is generated for each cycle of the current Analog Generator waveform.

- **Digital Gen**

A trigger transition is generated for each cycle of the current Digital Generator waveform.

- **Jitter Gen**

A trigger transition is generated for each cycle of the current Jitter Generator waveform.

- **Trig In (Ext)**

A trigger transition is generated for each external trigger transition received at the **TRIG IN** BNC connector.

- **Line (Mains)**

A trigger transition is generated for each cycle of the AC mains line voltage.

- **ChA Rcv Sub-Frame**

A trigger transition is generated at the beginning of each Channel A subframe (each X-preamble plus each Z-preamble) in the interface signal received at the digital input. If there is jitter in the received waveform, that jitter will be reflected in the trigger waveform.

- **ChB Rcv Sub-Frame**

A trigger transition is generated at the beginning of each Channel B

subframe (each Y-preamble) in the interface signal received at the digital input. If there is jitter in the received waveform, that jitter will be reflected in the trigger waveform.

■ **ChA Rcv Sub-Frame DeJitt**

A trigger transition is generated at the beginning of each Channel A subframe (each X-preamble plus each Z-preamble) in the interface signal received at the digital input, after the signal has been re-clocked to remove jitter.

■ **ChB Rcv Sub-Frame DeJitt**

A trigger transition is generated at the beginning of each Channel B subframe (each Y-preamble) in the interface signal received at the digital input, after the signal has been re-clocked to remove jitter.

■ **Rcv Block (192 frames)**

A trigger transition is generated at the beginning of each Status Block frame (each Z-preamble) in the interface signal received at the digital input. This occurs once every 192 frames.

■ **Rcv Error**

Four “receive error” conditions in the interface waveform are defined and flagged. See **Error Indicators** on page 68. Select the error conditions which you wish to use as triggers in the check boxes on the Main Trigger panel. When any of these selected conditions occurs in the interface signal received at the main digital input, a trigger transition will be generated.

■ **ChA Xmit Subframe**

A trigger transition is generated at the beginning of each Channel A subframe (each X-preamble plus each Z-preamble) in the interface signal transmitted at the digital output. If jitter has been added to the digital output, that jitter will be reflected in the trigger waveform.

■ **ChB Xmit Subframe**

A trigger transition is generated at the beginning of each Channel B subframe (each Y-preamble) in the interface signal transmitted at the digital output. If jitter has been added to the digital output, that jitter will be reflected in the trigger waveform.

■ **ChA Xmit Subframe DeJitt**

A trigger transition is generated at the beginning of each Channel A subframe (each X-preamble plus each Z-preamble) in the interface signal transmitted at the digital output, before the addition of any jitter.

■ **ChB Xmit Subframe DeJitt**

A trigger transition is generated at the beginning of each Channel B

subframe (each Y-preamble) in the interface signal transmitted at the digital output, before the addition of any jitter.

- **Xmit Block (192 frames)**

A trigger transition is generated at the beginning of each Status Block frame (each Z-preamble) in the interface signal transmitted at the digital output. This occurs once every 192 frames.

- **ChA Sync/Ref Rcv Sub-Frame**

A trigger transition is generated at the beginning of each Channel A subframe (each X-preamble plus each Z-preamble) in the interface signal received at the **SYNC/REF IN** input.

- **ChB Sync/Ref Rcv Sub-Frame**

A trigger transition is generated at the beginning of each Channel B subframe (each Y-preamble) in the interface signal received at the **SYNC/REF IN** input.

- **Sync/Ref Rcv Block (192 frames)**

A trigger transition is generated at the beginning of each Status Block frame (each Z-preamble) in the interface signal received at the **SYNC/REF IN** input. This occurs once every 192 frames.

- **Sync/Ref Rcv Error**

Four “receive error” conditions in the interface waveform are defined and flagged. See **Error Indicators** on page 68. Select the error conditions which you wish to use as triggers in the check boxes on the Main Trigger panel. When any of these selected conditions occurs in the interface signal received at the **SYNC/REF** input, a trigger transition will be generated.

Auxiliary Control Output and Input

The Auxiliary Control Output and Input ports provide the ability to transmit or receive control signals from external devices.

These are general-purpose 8-bit digital ports available on two 9-pin D-Sub connectors on the ATS-2 rear panel, and are intended for direct interface to LSTTL circuitry, or via LSTTL-compatible drivers to relays. Applications include control of mains power, indicator lights, annunciators, and so on; and reading and display of device states.



To set bits for the Auxiliary Control Output or view the bit states at the Input, click **Panels > Auxiliary Control I/O** or the **Auxiliary Control I/O** button on the Panels toolbar.

Figure 273. The Auxiliary Control I/O panel.

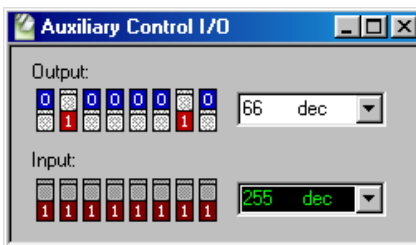

You can set the output directly from the panel by clicking on the binary switches. The value of your setting is displayed in the field to the right in decimal, hexadecimal or octal units.

The Auxiliary Control I/O is a sweepable setting.

The input states are read and displayed below the output settings. This reading is updated at a rate of 4/s.

CONNECTOR PIN	FUNCTION
1	Bit 7 (MSB)
2	Bit 6
3	Bit 5
4	Bit 4
5	Bit 3
6	Bit 2
7	Bit 1
8	Bit 0 (LSB)
9	ground

Table 3. Auxiliary Control port connector pin assignments, output and input.

The pin connections of these ports are shown in the table above. The current drive capability of each bit line is 5 mA; the output impedance is 390 Ω.

Chapter 23

Automating Tests

Introduction

Almost every ATS command and panel setting has a corresponding OLE (Object Linking and Embedding) command. OLE automation can be used by programming languages such as Microsoft Visual Basic to control and automate software functions in independent applications, such as ATS.

AP Basic is a programming language specifically designed for ATS-2 and included with the ATS software. If you are familiar with Visual Basic you will find many similarities in the languages; you can also use programs written in Visual Basic to control ATS-2.

Using AP Basic, you can write macros (automation programs, also called scripts or procedures) which issue ATS OLE commands, open files, wait for data readings to satisfy necessary conditions, create reports, save information to disk and communicate with other Windows programs. You can design and use custom user interfaces to simplify macro operation and guide operators through a process. Using OLE, it is possible to control ATS-2 from other programs such as word processors or spreadsheets. Virtually every function of ATS-2 can be automated with AP Basic.

AP Basic macro files for ATS-2 are saved with the filename extension .atsb.

Learn Mode

An experienced programmer with a good knowledge of AP Basic can sit down at a text editor and write a macro to run an ATS test. It's much easier, though, to use Learn Mode.

Learn Mode records every appropriate operation of the ATS software to an AP Basic macro file. It is similar to features in other applications called *macro recorders*. Learn Mode is often the easiest way to create a macro, whether simple or complex.



To enter Learn Mode, click the **Start Learn Mode** button on the Learn Mode toolbar; or, from the Main menu, choose **Macro > Learn Mode** or **Utilities > Learn Mode**. An AP Basic macro will open in the Macro Editor, and each ATS keystroke and mouse click will be entered into the Macro Editor as a line of AP Basic code, as you set up and run a test.



On the Macro and Utilities menus a checkmark will remain next to the **Learn Mode** choice while ATS is in Learn Mode, and the shape of the mouse pointer will change to that of an audio cassette, indicating that a recording is being made. To prevent a particular mouse click from being entered into the macro, press and hold the keystroke combination **Ctrl-Shift** while clicking. This temporarily suspends Learn Mode.



To exit Learn Mode, click the **Stop Learn Mode** button on the Learn Mode toolbar; or, from the Main menu, choose **Macro > ✓ Learn Mode** or **Utilities > ✓ Learn Mode**. The mouse pointer will return to its normal shape, the checkmark next to the **Learn Mode** menu choice will disappear and you will be prompted to save the macro.

The Macro Editor

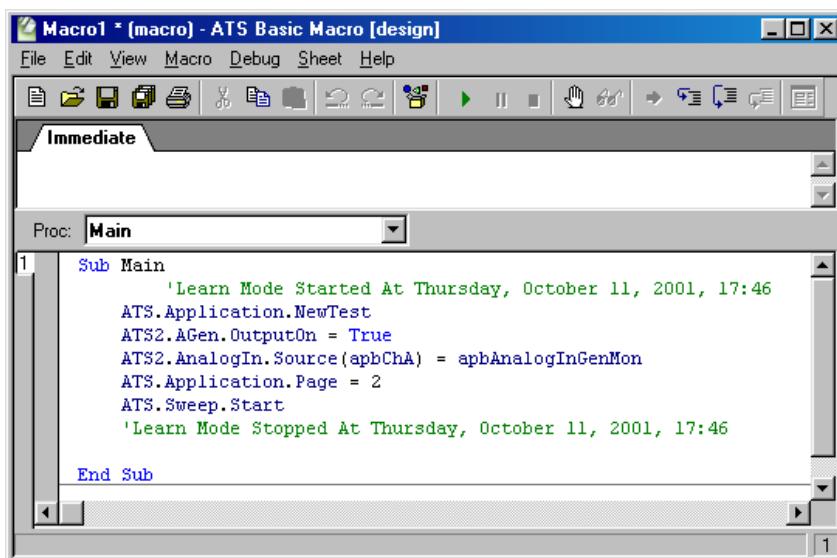

Figure 274. The Macro Editor, showing a new macro created in Learn Mode.

The Macro Editor is a text editor with dedicated features for editing AP Basic macros, including macro navigation and debugging tools. You can begin a macro “from scratch” in the Macro Editor, or edit macros created by Learn Mode or opened from disk.

AP Basic Documentation

The *AP Basic User’s Guide and Language Reference* is the primary reference for using automation with Audio Precision instruments.

Since each instrument has different capabilities, each has a different set of OLE commands. For ATS-2, these are discussed in detail in the *AP Basic Extensions Reference for ATS-2*.

Both of these documents are included as PDF files on the Audio Precision Resources Disc.

Chapter 24

Regulation

Regulation is a software servo-mechanism which enables you to automatically steer test parameters toward a specific measured value.

Let's say, for example, that you would like to find the point at which a power amplifier produces 1% THD+N at its output. With regulation, ATS-2 can adjust a generator output amplitude while monitoring the DUT THD+N, guiding the generator up and down to the level where 1% THD+N is measured. At this point, the DUT output wattage can be measured and noted as the power level at 1% THD+N.

Figure 275. The ATS Regulation panel.

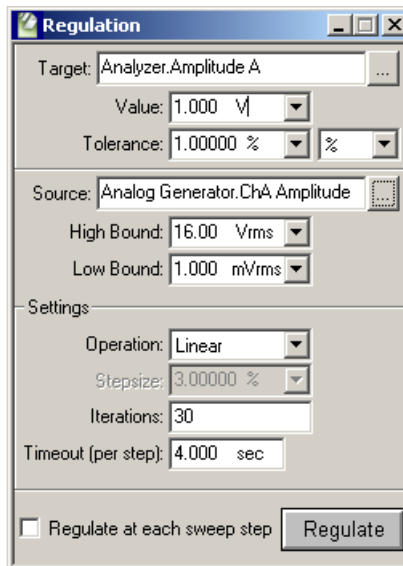

Here's another example: you'd like to find the exact frequency at which the DUT response is 3 dB down from the midband level reference. ATS's regulation function can adjust a generator frequency while monitoring the

DUT output amplitude, guiding the generator up and down to the precise frequency at which -3 dB is measured.

Figure 276. The ATS Regulation Target Browser.

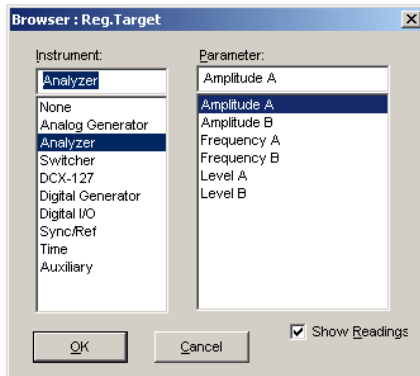

The Regulation panel enables you to select:

- a **Target** parameter
This is the parameter ATS is monitoring as it is steered toward the target value. Use the target browser to select the target parameter from the ATS instrument readings provided.
- a target **Value**
This is the reading from the DUT that you are trying to attain.
- a target value **Tolerance**
This is the range around the target value that is acceptable for your test.

Figure 277. The ATS Regulation Source Browser.

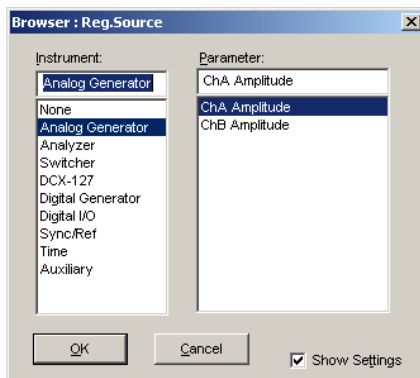

- a **Source** parameter
This is the ATS setting which will be varied in an attempt to steer the target parameter toward the desired value. Use the source browser to

select the source parameter from the ATS instrument settings provided.

- source **High** and **Low Bounds**

These are the extremes between which you want to confine the source variations.

There are also several panel settings which affect regulation performance:

- **Operation**

Operation sets one of five algorithms which determine how the regulation operation proceeds:

- **Linear**

The assumption for **Linear** operation is that any change in the Regulation **Source** parameter will cause the same change in the regulated **Target** parameter. This is the normal relationship, for example, in the input and output amplitudes of an amplifier: a +2 dB change at the input should make a +2 dB change at the output.

Linear is the best choice and the fastest option for setting DUT outputs to a reference level, or making frequency response measurements at a constant output level.

In **Linear** operation, the regulation algorithm is directed to jump to the **Target** value in a single step, and the **Stepsize** field is unavailable.

- **+Normal**

The assumption for **+Normal** is that any change in the Regulation **Source** parameter will cause a proportional change in the regulated **Target** parameter. This is the normal relationship between generator amplitude and measured THD of an amplifier near its maximum power point, or between generator frequency and measured high-pass filter output amplitude on the attenuation skirt.

- **- Normal**

The assumption for **- Normal** is that any change in the Regulation **Source** parameter will cause an inverse proportional change in the regulated **Target** parameter. This is the normal relationship between generator frequency and measured low-pass filter output amplitude on the attenuation skirt, or between generator amplitude and measured THD+N in relative units (dB or %) in the lower, noise-limited range of a DUT.

- **Maximum**

Maximum regulates in search of a maximum or peak value, steering the **Source** parameter to find the peak.

- **Minimum**

Minimum regulates in search of a minimum peak value, steering the **Source** parameter to find the minimum peak.

- **Stepsize**

The **Stepsize** field controls the initial size of the increments which will be made to the regulation **Source** parameter. When the regulated parameter reading first passes beyond the **Target** value, the actual step size will be decreased and the direction of change reversed as the algorithm goes into a binary search mode to determine the final value to regulate the measurement. **Stepsize** may be set in a number of ratio units including %, **X/Y**, and **dB**. The optimum value for **Stepsize** depends upon the DUT and the distance to the **Target** value from the initial starting value. Large steps will reach and pass the **Target** rapidly, but more iterations will be required to reduce the step size and bring the measurement into regulation. Smaller steps will take longer to reach the approximate area near the **Target** value but may regulate the measurement more rapidly.

- **Iterations**

Iterations determines the maximum number of regulation steps which will be made for each measurement. Regulation is considered successful if the target **Value** is attained within **Tolerance** without exceeding **Iterations**. If Regulation is unsuccessful an “Unregulated” message is issued, and an “R” is entered at the measurement on the Graph, in the Data Editor and in the Log file, if enabled.

For **+Normal**, **- Normal** and **Linear** operations, the **Iterations** field limits the maximum number of steps which the regulation algorithm will make in the search for the **Target** value. **Iterations** should be large enough to permit successful regulation.

In **Maximum** and **Minimum** modes, the **Iterations** field determines the number of times that the measured value passes through the target value before the algorithm halts. A larger **Iterations** value will produce a more precise location of the target, but will take longer to complete. Generally, broad peaks and dips can be located with a smaller **Iterations** value, and sharper peaks or dips require a larger **Iterations** value.

- **Timeout (per step)**

The instrument readings used for regulation are first processed through the sweep Settling algorithm. See page 278 for a discussion of Settling. In some circumstances, depending upon the variability of the readings and the Settling settings, Settling cannot be satisfied and no data for that step will be forwarded to the Regulation panel. The **Timeout** field enables you to enter a time interval beyond which regulation will not wait for a settled reading. When a reading times

out, the most recent stream of up to 32 readings from the instrument will be averaged and used as input to regulation.

Once you have made all your settings, click the **Regulate** button to perform regulation.

Check **Regulate at each sweep step** to set the automatic option for sweep operation.

Examples of Regulated Sweeps

Here are several applications of regulated sweeps:

- Using Regulation to hold power amplifier output distortion constant (at 1.0%, for example) by varying generator amplitude, but plotting amplifier output power versus generator frequency to produce a graph of power bandwidth.
- Using Regulation to find a -3 dB point on a DUT, then making a single-point sweep to display the measured frequency at that point.
- Using Regulation to hold the modulation percentage (or *deviation*) of a preemphasized broadcast transmitter constant while measuring and plotting THD+N versus frequency.
- Using Regulation to hold the modulation percentage (the deviation) of a preemphasized broadcast transmitter constant while measuring and plotting the generator amplitude versus frequency required to obtain that constant modulation value.

This curve is essentially a modulation sensitivity test. Plotting the generator amplitude using normal units will result in a curve that is inverted from the actual preemphasis curve shape of the transmitter. Use **dBrInv** (relative decibels, inverted) for the generator units to invert the trace and produce a preemphasis curve.

Chapter 25

Configuration and the Utilities Menu

The Utilities menu offers access to the system Configuration panel and also to several utility functions and programs. We'll look first at the Configuration panel. Go from the Main Menu to **Utilities > Configuration**.

Figure 278. The ATS Utilities Menu.

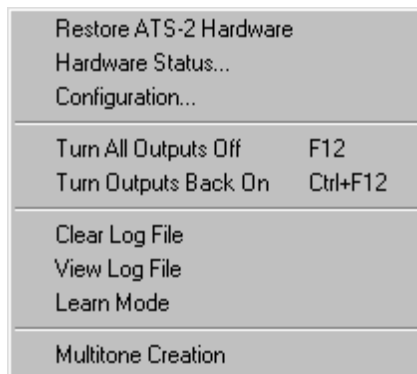

The Configuration panel

The Configuration panel allows you to set your preferences for ATS behavior. There are three tabbed pages on the Configuration panel.

General

Figure 279. The General Configuration tab.

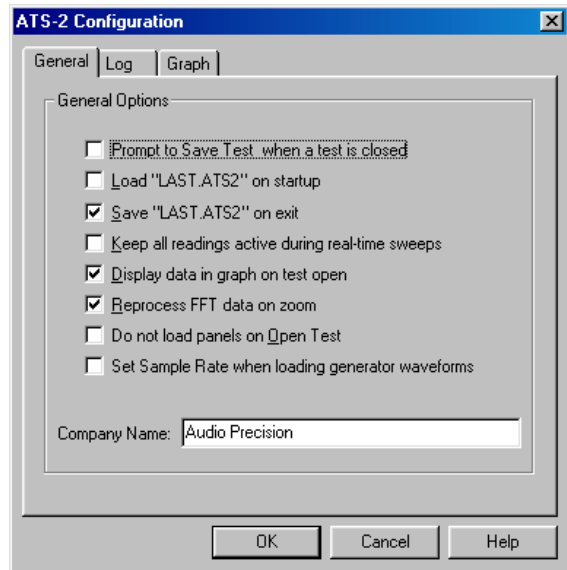

The General configuration page enables you to set a number of general behaviors for ATS. These are:

- **Prompt to Save Test when a test is closed**

Several commands (such as File New Test, File Open Test or File Open Data) will close the current test, clearing the test data from memory. If this box is checked, a dialog box will open when a test is about to be closed, prompting you to save the test before closing it.

- **Load “LAST.ATS2” on startup**

If this box is checked, when ATS is launched the program will automatically load the test named Last.ats2.

- **Save “LAST.ATS2” on exit**

If this box is checked, when ATS is closed the program will automatically save the current test in memory as Last.ats2.

- **Keep all readings active during real-time sweeps**

Normally, ATS meters are constantly updating their readings. If this box is checked, all meters on all open panels will continue to update their readings during the progress of real-time sweeps. This enables you to view non-swept parameters during a sweep.

If the box is not checked, only the instrument readings selected as sweep parameters will update their readings, which enables sweeps to run faster.

This setting does not apply to batch mode sweeps.

- **Display data in graph on test open**

If this box is checked, data in a test is automatically graphed (and compared to limits, if any) when the test is opened. If the box is not checked, the data is loaded with the test but is not automatically graphed.

- **Reprocess FFT data on zoom**

If this box is checked, each time a Graph zoom is initiated for an FFT plot, the data acquisition is re-processed with an automatic **Sweep Reprocess Data (Ctrl-F6)** command. Although this processing takes more time, it assures that the plotted resolution is always the maximum supported by either the number of points graphed or by the FFT length. See **Retransforming and Reprocessing Data** on page 157 and **Zoom** on page 286.

- **Do not load panels on Open Test**

Normally, when a test is opened, all the instrument panels, bar graphs and graphs are loaded on each page at the location and size that they were when the test was saved. If this box is checked, the instrument control settings, including waveform, amplitude, frequency, Analyzer instrument and function, sweep settings and so on, are loaded without changing the current panel and graph size and location.

- **Set Sample Rate when loading generator waveforms**

Most applications using arbitrary waveforms require that they be played back at the same sample rate at which they were created. Audio Precision waveform files contain information on the design value of the sample rate. If this box is checked, ATS automatically sets the correct internal sample rate when a waveform file is loaded. See **Arbitrary Waveforms** on page 91 and page 114.

At the bottom of the page is the **Company Name** field, where you can enter the name you would like to appear on ATS graphs. If a name is entered here, you have the option enabling or disabling screen or print display in the Graph Label dialog box or in the Page Setup dialog box.

Log

Figure 280. The Log Configuration tab.

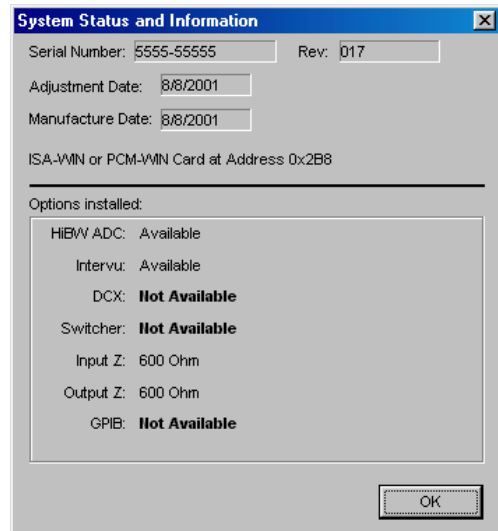

The Log File

The log file is an optional record of many important ATS operations, including test names, date and time of each running of tests, limits failures, file loading and saving activity and error messages. New information is appended to the log file, so a log file can become a complete record of an entire audio testing procedure.

The log file is a standard ASCII text file, readable by text editors such as Windows Notepad and other applications. A log file has the extension .alg.

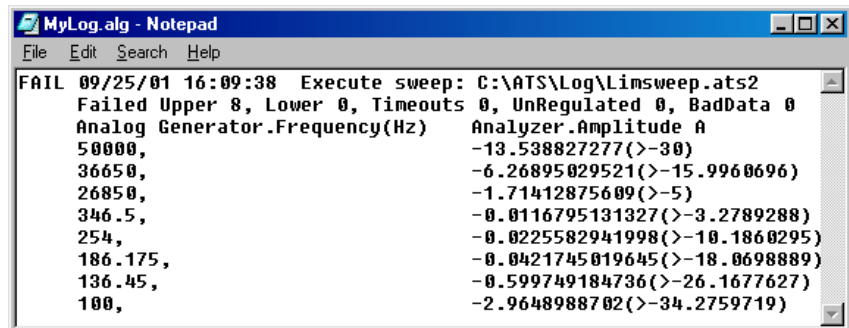

Figure 281. A typical ATS log file, showing test file name and path, date and time, **FAIL** message and a list of the failed point values.

The Log configuration page enables you to set Log file options for ATS. These are:

■ **Enable Logging**

Check this box to enable logging. Type the filename and path of the log file. The ATS default is log.alg, with a path of C:\Documents and Settings\username\My Documents\Audio Precision\ATS n.nn\.

■ **Include in Log File**

• **Error Messages**

If this box is checked, any Windows or ATS error messages that occur during the logging period will be written to the log file.

• **File I/O Activity**

If this box is checked, a text message will be written to the log file for every disk file opened and every file saved to disk. The message includes the name and full path of the file and the date and time at which it was saved or opened.

■ **Sweep Activity**

• **Test Name**

If this box is checked, the filename and full path of the executed test is written to the log file.

• **Graph Title, Time and Date**

If this box is checked, the graph title, date and time of the test are written to the log file.

• **Pass/Fail Message**

If this box is checked, an error summary message will be written to the log file each time a test is run. The message will say **PASS** or **FAIL**, followed by the number of measurements below the lower limit, the number of measurements above the upper limit, and the number of timeouts which occurred.

■ **Sweep Data**

• **None**

If this box is checked, no sweep point values will be written to the log file.

• **All**

If this box is checked, all sweep point values will be written to the log file.

• **Failed Only**

If this box is checked, only those sweep point values that have failed the limits will be written to the log file.

Graph

Figure 282. The Graph Configuration tab.

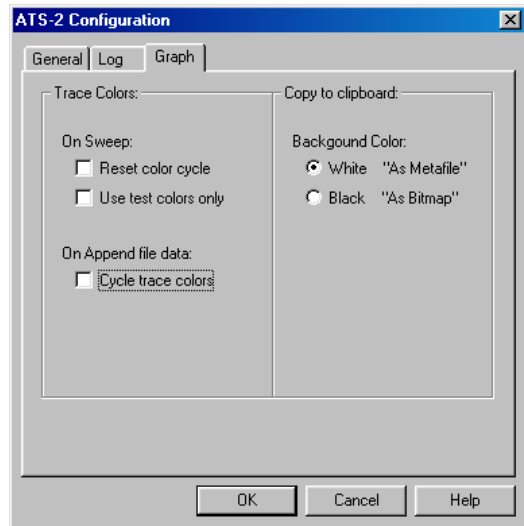

The Graph configuration page enables you to set the Graph color assignment and copy options for ATS. See **Trace Colors** on page 298, **Copying a Graph to the Clipboard** on page 334 and **Bitmaps and Vector Graphics**, page 335.

The Graph **Trace Colors** options are:

- **On Sweep:**

- **Reset color cycle**

If **Reset color cycle** is checked, each new sweep will reset the color cycle, so that the first trace of the sweep is cyan.

If the **Reset color cycle** is unchecked, new sweeps will use the color cycle. If you manually change any color-to-**Data** assignment, ATS will maintain your new color assignments throughout subsequent sweeps.

- **Use test colors only**

When you are appending current sweeps to a test file loaded from disk using the **Append** checkbox on the Sweep panel and **Use test colors only** is checked, the newly appended sweeps will maintain the colors used in the file you have loaded.

If **Use test colors only** is unchecked, any newly appended sweeps will move through the color cycle.

■ On Append file data:**• Cycle trace colors**

When you are appending a sweep from disk to a sweep in memory using the **File Append** command and **Cycle trace colors** is checked, the appended sweep will start at the next color in the current sweep and move normally through the color cycle. If **Cycle trace colors** is unchecked, the colors of the sweep you are appending from disk will be maintained and not overridden by the color cycle.

The Graph **Copy to clipboard** options are:

■ Background Color:**• White “As Metafile”**

If **White “As Metafile”** is checked, the Copy command copies the current graph to the Windows clipboard as a vector graphic drawing in the Windows metafile format. The graph is rendered as black and colored lines on a white background.

• Black “As Bitmap”

If **Black “As Bitmap”** is checked, the Copy command copies the current graph to the Windows clipboard as a bitmap image in the Microsoft bitmap format. The graph is rendered as white and colored lines on a black background, as it appears in the Graph panel.

Restoring the ATS-2 Hardware

If the ATS-2 hardware has lost power or its APIB connection, the **Utilities > Restore Hardware** command will set the instrument to the current software settings.

Utilities > Restore Hardware can also be used as a hardware reset if the instrument does not appear to be responding normally.

Hardware Status

Figure 283. The ATS Hardware Status panel.

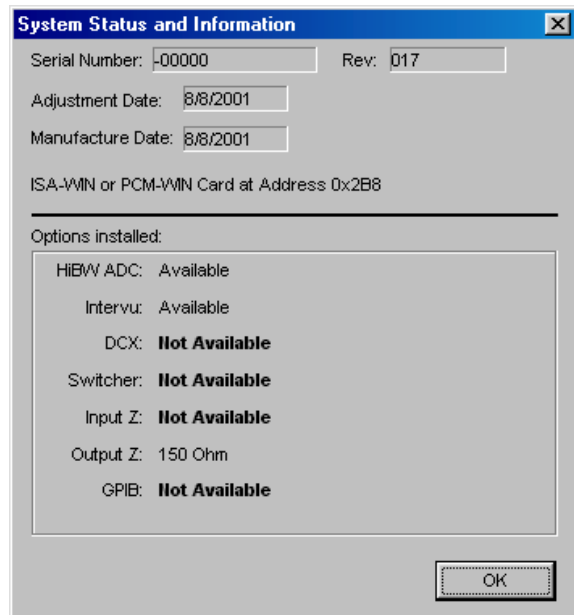

The **Utilities > Hardware Status** command opens the System Status and Information dialog box, which reports a number of ATS and ATS-2 conditions.

Turn All Outputs OFF / ON

The **Utilities > Turn All Outputs Off** issues the same command as the function key **F12**, the “panic button.” Either of these turns off all generator outputs.

The **Utilities > Turn Outputs Back On** issues the same command as the key combination **Ctrl-F12**. Either of these turns on any generator outputs previously turned off by the panic button.

Clear Log File

This command clears all the information from the log file. It does not delete the file, but leaves it empty. See **The Log File** on page 364.

View Log File

This command opens the log file in Notepad for viewing or printing. See **The Log File** on page 364.

Learn Mode

Learn Mode records every appropriate operation of the ATS software to an AP Basic macro file. It is similar to features in other applications called *macro recorders*. Learn Mode is often the easiest way to create a macro.

Choose **Utilities > Learn Mode** to enter Learn Mode. An AP Basic macro will open in the Macro Editor, and each ATS setting you make is entered in AP Basic in the Macro Editor, as you work.

On the Utilities menu a checkmark will remain next to the **Learn Mode** choice while ATS is in Learn Mode, and the shape of the mouse pointer will change to that of an audio cassette, indicating that a recording is being made.

Choose **Utilities > Learn Mode** to exit Learn Mode. The mouse pointer will return to its normal shape, the checkmark next to Learn Mode will disappear and you will be prompted to save the macro.

See Chapter 23 for more information on automating tests with AP Basic.

Multitone Creation

A comprehensive multitone creation utility has been provided with ATS-2 to facilitate making custom waveform files for multitone testing. Choose **Utilities > Multitone Creation** to open the program.

See **Creating Multitone Waveform Files** on page 236.

Appendix A

Units of Measurement

Introduction

Many different units of measurement are used to describe audio signals and audio system components and characteristics. ATS offers a wide choice of units of measurement for both setting and reading values.

- Values can be expressed in absolute terms such as the volt, the watt, the ohm, the hertz and the second.
- Values can also be displayed as the ratio of one value to another with units like the decibel or percent.
- In addition, ATS provides relative units which express the relationship of a value to a user-supplied reference, or to another ATS setting.

Figure 284. Selecting Units of Measurement for ATS readings and settings.

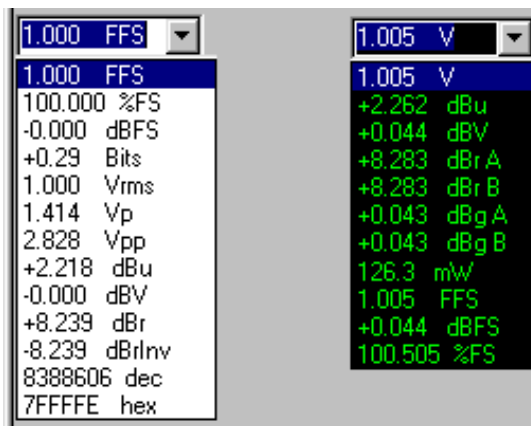

Depending on the current ATS configuration and the parameter you are setting or observing, different units choices will be available. Any reading display or setting field which has a drop-down arrow offers a list of units of

measurement. Click the arrow to display the list and choose the units you prefer. Setting fields also allow direct entry in the field to select units. When you request a value in different units, ATS does the calculation for you.

The decibel

The decibel or dB, in one form or another, is arguably the most widely-used unit of measurement in the field of audio. The ear's response to both sound amplitude and frequency is usually best examined in logarithmic terms, and the dB, being a logarithmic unit of measurement, is often the right choice.

It is important to remember that the dB is always a ratio of two values, and for a meaningful expression both of the values must be known. While "8 dB" means nothing, "8 dB below the input signal" gives us a reference and is meaningful. Whenever using the simple dB unit, the expression must identify the reference value.

A large collection of units of measurement (we've seen it referred to as "the dB zoo") uses the decibel ratio with the reference stated as part of the definition of the unit. Examples include dBV (decibels in relation to 1 V rms); dBu (decibels in relation to .7746 V rms); dBFS (decibels in relation to digital full scale); dB spl (decibels of sound pressure in relation to 20 micropascals of pressure) and so on.

The formula for decibels in voltage amplitudes is

$$dB = 20 \log_{10} \left(\frac{V_1}{V_2} \right)$$

where V_1 and V_2 are the two related voltages.

The formula for decibels in power amplitudes is

$$dB = 10 \log_{10} \left(\frac{P_1}{P_2} \right)$$

where P_1 and P_2 are the two related powers.

Analog Amplitude Units

V—volts (unqualified). This unit is used only on the Audio Analyzer and the Harmonic Distortion Analyzer panels. Because of the detector differences between the Audio Analyzer Function meters and the other meters on these panels, in some configurations **V** may have different meanings. Specifically, on all Audio Analyzer and the Harmonic Distortion Analyzer reading and reference fields *except* the Function meters, **V** means volts (rms). Since the Function meters have switchable detectors, the **V** units selection takes its qualification, that is, V (rms) or V (quasi-peak) from the detector selection.

V_{rms}—volts (rms). This unit is used only on the Analog Generator and Digital Generator panels, and this setting accurately calibrates the generator output in **V_{rms}** when a sinewave is being generated. When using other waveforms (such as noise, squarewaves, multitone, IMD test signals, and so on) with **V_{rms}**, the signal has the same peak-to-peak voltage as a sinewave at that setting, as shown in Figure 285. For the analog outputs, **V_{rms}** is an open-circuit value and the actual output voltage will be less with a load.

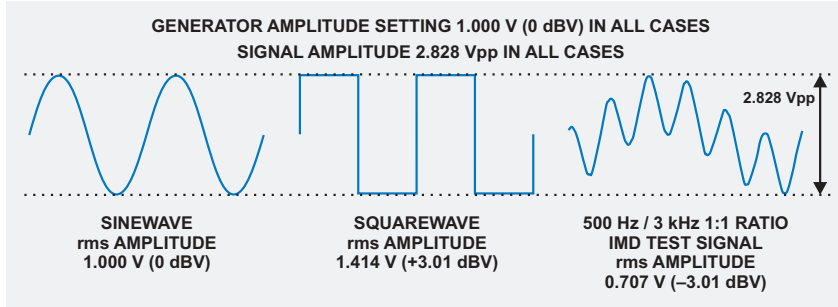

Figure 285. ATS-2 generator output calibrations

V_p—volts (peak). This unit is used on the output setting fields on the Analog Generator and Digital Generator panels and on the **Peak Mon** meters on the Analog Input panel. This calibration assumes a sinewave, and is arithmetically scaled to the **V_{rms}** value by $\sqrt{2}$, approximately 1.414. Since non-sinusoidal waveforms are calibrated to have the same peak-to-peak value as a sinewave, the **V_p** unit should be correct for most non-sinusoidal waveforms. When used with the Analog Generator, **V_p** is an open-circuit value and the actual output voltage will be less with a load.

V_{pp}—volts (peak-to-peak). This unit is used on the output setting fields on the Analog Generator and Digital Generator panels and on the **DIO Input** meter. This calibration assumes a sinewave, and is arithmetically scaled to the **V_{rms}** value by $2 \cdot \sqrt{2}$, approximately 2.828. Since non-sinusoidal waveforms are calibrated to have the same peak-to-peak value as a sinewave, the **V_{pp}** unit should be correct for most non-sinusoidal waveforms. When used with the Analog Generator, **V_{pp}** is an open-circuit value and the actual output voltage will be less with a load.

W—watts. This unit of power is used on the Analog Generator and the Audio Analyzer panels. Watts is calculated based on the $P = V^2/R$ relationship. On the Analog Generator panel, V is the setting in **V_{rms}**, and R is the combination of the ATS-2 source resistance and the resistance of the external load; for an accurate setting, you must enter the value of the load resistance in the **References: Watts** field on the generator panel. On the Audio Analyzer panel, V is the measured rms voltage and R is the value of

the source resistance, which you must enter in the **References: Watts** field on that panel.

dBm—decibels relative to 1 mW. Like **Watts**, the **dBm** is a unit of power used on the Analog Generator and the Audio Analyzer panels. **dBm** is calculated based on the $P = V^2/R$ relationship. On the Analog Generator panel, V is the setting in V_{rms} , and R is the combination of the ATS-2 source resistance and the resistance of the external load; for an accurate setting, you must enter the value of the load resistance in the **References: dBm** field on the generator panel. On the Audio Analyzer panel, V is the measured rms voltage and R is the value of the source resistance, which you must enter in the **References: dBm** field on that panel. If you have the 600 Ω impedance option, you can select that value on the Analog Input panel as the input termination impedance. 600 Ω is the most common circuit impedance value for dBm measurements.

*dBm is rarely the correct choice of units for audio measurements. dBm units are often mistakenly chosen when dBu units should be used. See the sidebar **dBm versus dBu** on page 375.*

dBu—decibels relative to 0.7746 V rms. This is usually the correct choice of units for audio levels in professional audio equipment and systems. The dBu is a voltage unit and, unlike the dBm, is independent of circuit impedance. When used with the Analog Generator, **dBu** is an open-circuit value and the actual output voltage will be less with a load. See the sidebar **dBm versus dBu** on page 375.

dBm versus dBu

Although still in use, the dBm unit of measurement is a legacy from earlier days of audio technology when measuring the audio power transferred in impedance-matched circuits was important. The dBm is a unit of power (referenced to 1 mW), and the audio circuits of the day often had an impedance of 600 Ω . The voltage drop across a 600 Ω resistor dissipating 1 mW is 0.7746 V, and this voltage (which reads 0 dBm on a dBm meter across 600 Ω) came to be regarded as “zero level” in professional audio circles.

However, most audio circuits do not have a 600 Ω impedance. Microphone circuits may be 150 Ω , and headphone circuits may be 8 Ω . This is even more the case in modern design, where circuit outputs often have very low impedances (from perhaps 10 Ω to around 100 Ω) and input circuits often are “bridging,” with impedances of 10,000 Ω or even 100,000 Ω . A milliwatt dissipated in any of these circuits will not read 0.7746 V, and the dBm meter (which is simply a voltmeter calibrated for a 600 Ω circuit) will be in error. The circuit impedance must always be taken into account in power measurements.

Because of this, the dBm can be misleading. It has fallen out of use in the last 20 years (except for specific applications where power transfer is an important consideration and the circuit impedances are known) and its place in professional audio has largely been taken by the dBu, where the “u” can be taken to mean “unloaded.” The dBu is a valid level measurement in audio circuits of any impedance.

The value of 0 dBu, 0.7746 V rms, is the same voltage as 0 dBm in a 600 Ω circuit; in 600 Ω , 0 dBu = 0 dBm. However, at other levels the voltage divider formed by the source and termination impedances will cause the values of dBu and dBm to diverge. In other impedances, the values will not be equivalent even at the zero level.

Unless you know the circuit impedance and have a clear reason to use the dBm reference, use dBu.

dBV—decibels relative to 1.000 V rms. This is usually the correct choice of units for audio levels in consumer audio equipment and systems. The dBV is a voltage unit and, like the dBu, is independent of circuit impedance. When used with the Analog Generator, **dBV** is an open-circuit value and the actual output voltage will be less with a load.

Digital Amplitude Units

FS: Digital Full Scale

All of the units for digital domain audio amplitudes refer to digital full scale. In pulse-code-modulation (PCM) audio, the amplitude of each audio sample is represented as a number. The maximum and minimum values of these numbers vary with the digital word length, but they are precisely defined. A signal which attempts to exceed these values can drive a digital system into overload; in a popular expression, the signal “runs out of numbers.”

Word Length	Positive Full-Scale Value	Negative Full-Scale Value
16-bit	7FFF Hex	8000 Hex
24-bit	7FFFFFF Hex	800000 Hex

The Audio Engineering Society defines digital full scale in terms of a sine wave whose peaks just reach the maximum positive and negative digital codes. The rms value of this sine wave is the full-scale reference, defined as 1 FFS or 0 dBFS. Note that other waveforms (noise or music, for example) have different crest factors than a sine wave (crest factor is the ratio of a signal’s peak amplitude to its rms amplitude) and will have different rms values at the amplitude at which their peaks just reach the maxima.

A consequence of defining full scale as an rms value is that high-level signals that have a lower crest factor than a sine wave can display rms values greater than 1 FFS or 0 dBFS, even though the digital maximum and minimum codes are not exceeded. For example, a square wave whose top and bottom are at the maximum digital codes will have an rms value of 1.414 FFS or +3.01 dBFS. See Figure 286.

FFS—fraction of full scale, simply the ratio of the rms value of the signal to the full-scale value, expressed as a decimal fraction. A sinewave half the value of full scale would be indicated as 0.5 FFS. The lower levels often encountered in practical audio applications may be displayed as mFFS (milli fractions-of-full-scale, or FFS / 1000) and μ FFS (micro fractions-of-full-scale, or FFS / 1000000).

%FS—percent of full scale. This is the FFS value multiplied by 100. For example, a signal at 0.8 FFS is 80 % FS.

dBFS—decibels relative to full scale. This is a logarithmic measurement defined as $20 \cdot \log_{10}(FFS)$. For example, a signal at 0.1 FFS equals

–20 dBFS. dBFS is probably the most common unit of measurement used for digital audio amplitudes. 0 dB FS is the full-scale reference.

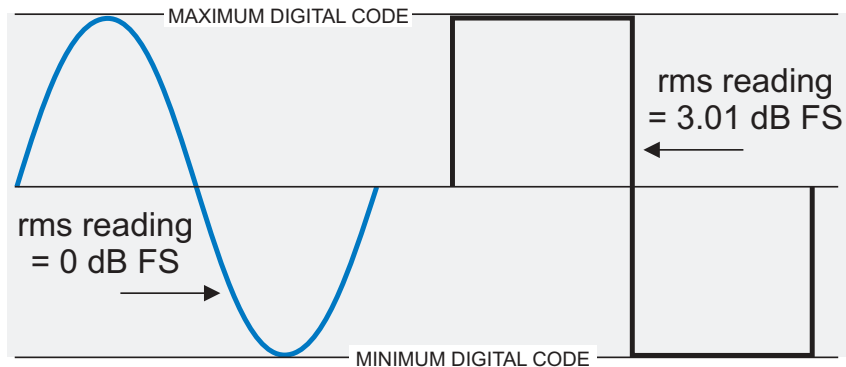

Figure 286. The squarewave has a lower crest factor than the sinewave. Since dBFS is defined in rms terms, a squarewave with the same peak value as a 0 dBFS sinewave will have a value of 3.01 dBFS.

bits—“Bits” is another way of describing the dynamic range of a digital converter, by converting a measured dynamic range value to the equivalent number of bits (the digital word length) that a signal would theoretically require to attain that dynamic range. The calculations take into account the effect of quantizing noise in the LSB by the 1.76 dB offset.

For example, the theoretical dynamic range of a 16-bit system can be calculated to be about 98.1 dB, using this formula:

$$\text{Dynamic Range} = 6.02 \cdot \text{number of bits} + 1.76 \text{ dB.}$$

Conversely, a dynamic range of 98.1 dB can be expressed as 16 bits.

Levels can also be expressed in this notation. The ATS **bits** unit is computed from dBFS using the following relationship, where *dB* is the level to be expressed, relative to full scale:

$$\text{bits} = \left(\frac{\text{dB} + 1.76}{6.02} \right).$$

For example, a signal at 0.0001 FFS, or –80 dBFS, can also be stated as –12.99 bits.

A consequence of the 1.76 dB offset is that a 0 dBFS signal displays a bits value of +0.29. A signal at –1.76 dB reads exactly zero bits.

Digital Data Units

dec, hex—decimal and hexadecimal. In addition to the digital domain units listed above, which are values integrated over one or more signal cycles, the ATS Digital Generator also has decimal and hexadecimal units available. These units express the numerical value of the embedded audio at each sample in either base 10 (decimal) or base 16 (hexadecimal) notation. The decimal and hexadecimal values refer to the peak value when used with the AC waveforms of the Digital Generator. The units **dec** and **hex** are used with the **Special: Constant Value** (digital dc) waveform selection, and with the **Offset** parameter of the **Sine: Offset** waveform.

Ratio Units

%—percent. The percent unit expresses the ratio of two numbers multiplied by 100. For example, a ratio of 0.7 is expressed as 70%.

dB—decibel. The decibel is always a ratio of two amplitudes, expressed logarithmically. For voltage amplitudes, decibels are computed by

$$dB = 20 \log_{10} \left(\frac{V_1}{V_2} \right).$$

See the sidebar on decibels, page 372.

PPM—parts per million. Parts per million expresses the ratio of two numbers, multiplied by 1,000,000. For example, a ratio of 0.00005 equals 50 PPM.

X/Y—The X/Y unit is the simple ratio between two numbers.

Specific ratio units, such as dBu or %Hz, are discussed in more detail in the relevant sections on amplitude or frequency units.

Relative Units

dBg—decibels relative to the Analog Generator amplitude setting.

dBr—decibels relative to a user-defined reference. The generators and the analyzer have separate, independent **dBr** or **dBr A/dBr B** fields in the **References** area of their respective panels. You can manually enter **dBr** values from the keyboard, or you can capture current ATS values for certain **Reference** fields as follows:

- Analog Generator dBr: Function Key **F3** or Edit Menu command **Set Generator dBr Ref**.

- Analyzer dBr: Function Key **F4** or Edit Menu command **Set Analyzer dBr Ref.**

dBrInv—decibels relative to a user-defined reference, inverted. This is exactly as described under **dBr** just above, but plotted upside down so that smaller or negative values are at the top of the graph, and larger or positive values are at the bottom.

The **dBrInv** units are commonly used in conjunction with Regulation mode, such as when measuring frequency response of a pre-emphasized broadcast transmitter. Inverted plotting of the generator levels required to produce constant modulation percentages produces the expected shape of the transmitter frequency response.

Frequency Units

Hz—hertz. This is the basic frequency unit, expressing the number of cycles of a signal in one second.

*The rest of the frequency units used in ATS measurements are relative units, expressing the relationship of the measured frequency to a reference frequency you have entered into the **References > Freq:** fields in the generator and analyzer panels.*

F/R—This is a frequency ratio unit, obtained by dividing the measured frequency F by the reference frequency R .

dHz—delta hertz. dHz is the difference in frequency between the measured frequency and the reference frequency; $dHz = F - R$.

%Hz—percent hertz. %Hz is obtained by dividing the measured frequency by the reference frequency and multiplying the result by 100; $\%Hz = 100 \cdot (F/R)$. For example, a measured frequency of 950 Hz would be expressed as 95.0 % of a reference frequency of 1 kHz.

cent—the cent unit is 1/100 of a musical half-tone interval, which in turn is the 12th root of 2:

$$cent = \frac{\sqrt[12]{2}}{100} \text{ Hz.}$$

octs—octaves. An octave is a frequency ratio of 2:1. For example, with a reference frequency of 1 kHz, a 2 kHz tone is expressed as +1.0 octave and a 500 Hz tone is expressed as -1.0 octave.

decs—decades. A decade is a frequency ratio of 10:1. For example, with a reference frequency of 500 Hz, a 5 kHz tone is expressed as +1.0 decade and a tone of 50 Hz is -1.0 decade.

d%—delta percent. d% is 100 times the ratio of dHz (or $F - R$) to the reference frequency R :

$$d\% = 100 \cdot \left(\frac{F - R}{R} \right).$$

For example, with a reference frequency of 1 kHz and a measured frequency of 950 Hz, the d% value is -5 %.

dPPM—delta parts per million. The dPPM unit is 1,000,000 times the ratio of dHz (or $F - R$) to the reference frequency R :

$$dPPM = 1,000,000 \cdot \left(\frac{F - R}{R} \right).$$

For example, with a reference frequency of 1 kHz and a measured frequency of 1,001 Hz, the dPPM value equals 1,000 dPPM.

Phase Unit

deg—degree. The degree is the basic unit of phase measurement, representing 1 / 360 of a complete revolution of phase.

Time Units

sec—seconds. Seconds are the basic time unit, abbreviated s. At values common in audio, the display may be in ms (milliseconds), μ s (microseconds) or ns (nanoseconds).

UI—unit interval. The unit interval is a convenient unit when examining digital interface signal timing, because by definition the UI is relative to the signal you are measuring; it scales with the interface data rate. The UI is defined as the *shortest nominal time interval in the coding scheme*. For an AES3 or IEC60958 signal there are 2 subframes of 32 bits per frame giving 64 bits per frame; after bi-phase mark encoding the pulse rate is nominally 128 pulses per frame. This interval, 1/128 of a frame, is the unit interval for AES3 and IEC60958 signals.

For a 44.1 kHz sampling rate, $1 \text{ UI} / (128 \times 44100) = 177.2 \text{ ns}$;

For a 48 kHz sampling rate, $1 \text{ UI} / (128 \times 48000) = 162.8 \text{ ns}$;

For a 96 kHz sampling rate, $1 \text{ UI} / (128 \times 96000) = 81.4 \text{ ns}$.

dBUI—decibels relative to 1 unit interval. The dB UI provides a logarithmic time unit scaled to the interface signal and is primarily used for FFT plots of jitter amplitude.

DCX-127 Units

The DCX-127 Multifunction Module brings additional measurement capabilities to ATS-2, and with these features come additional units of measurement.

DCX-127 Amplitude Units

Vdc—volts, dc. This is the basic unit of direct current (dc) electromotive force.

f(V)—“f of V” is a value which is a function of voltage. $f(V)$ is computed from

$$f(V) = (V + \text{offset}) \times \text{scale}.$$

See **DMM Offset and Scale Values** on page .

DCX-127 Resistance Units

Ohms—ohms. This the basic unit of electrical resistance, also shown by the symbol Ω .

f(O)—“f of O” is a value which is a function of resistance. $f(O)$ is computed from

$$f(O) = (\text{ohms} + \text{offset}) \times \text{scale}.$$

See **DMM Offset and Scale Values** on page .

DCX-127 Digital Input and Output Units

dec—decimal. The decimal unit converts the DCX-127 digital input and output between binary and decimal representation.

hex—hexadecimal. The hexadecimal unit converts the DCX-127 digital input and output between binary and hexadecimal representation.

oct—octal. The octal unit converts the DCX-127 digital input and output between binary and octal representation.

g(x)—(input). Like the scaled voltage and resistance units, $g(x)$ enables you to scale digital input units. The $g(x)$ unit is computed from

$$g(x) = x \cdot \text{scale}.$$

h(x)—(output). Like the scaled voltage and resistance units, $h(x)$ enables you to scale digital output units. The $h(x)$ unit is computed from

$$h(x) = \frac{x}{\text{scale}}.$$

Appendix B

The Digital Audio Signal

Almost all digital audio signals are a form of pulse code modulation (PCM). When an analog signal is digitized, the waveform is sampled at a regular rate (the sample rate) and the amplitude of the waveform at each sampling instant is acquired. Each value is encoded as a binary number, and each number is called a digital word. Placed end-to-end, the words form a string of pulses representing the binary numbers at each sampling instant.

PCM audio can be characterized in a number of ways, chief among them the sampling rate used and the degree of resolution of the numbering system. The sample rate can be low, such as the 8 kHz rate used in telecommunications; or high, such as the 192 kHz rate sometimes used for high-performance music recordings. Common sample rates are the 44.1 kHz rate used in Compact Disc (CD) recording, or the 48 kHz rate used in broadcast and professional audio recording. A key consideration in sample rate selection is signal bandwidth, which is always limited to one-half the sample rate, referred to as $F_s/2$ or the Nyquist frequency.

The numerical resolution of the signal depends on the number of bits assigned to encode the signal value. This is called the *word length*. Word length (or resolution) also varies between different systems, from perhaps 8 bits (256 discrete levels) to as high as 24 bits (16,777,216 discrete levels).

Figure 287. A 3 kHz sinewave sampled at 48 kHz.

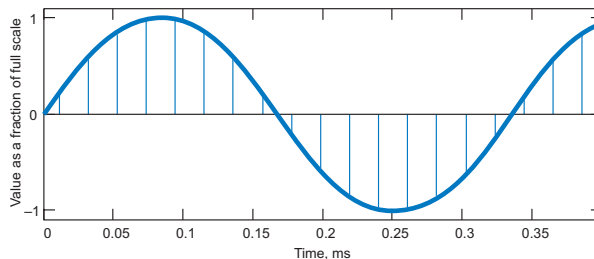

The Serial Digital Interface Signal

For reliable transmission and reception the PCM audio is encoded into an *interface signal* according to one of several international standards. The interface signal adds channel identification, synchronization data, status information, error correction and embeds the clock signal into the data stream.

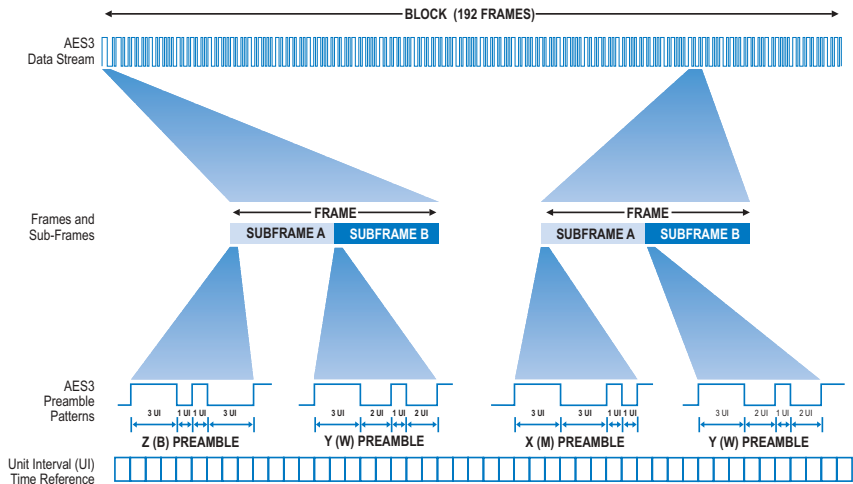

Figure 288. The AES3 serial interface signal data pattern.

The AES3 and IEC60958 standards define the digital audio interface signal for both professional and consumer use. There are several variations set out in the standards that are, for the most part, compatible.

The professional format is most often referred to as AES3, but is also called AES/EBU or IEC60958-4. There are also other variations of the professional format, such as AES3id and SMPTE 276M. These have the same data pattern but different electrical characteristics.

The consumer format is defined by IEC60958-3, and is also called S/PDIF or EIAJ. The consumer format differs from the professional in electrical characteristics and in the interpretation of Status Bits.

The standards specify not only the pattern and encoding of the PCM audio and other data, but also the electrical and mechanical aspects of the interface. The ATS-2 balanced digital connectors conform to AES3, and the unbalanced connectors (including the SYNC/REF BNC on the rear panel) satisfy AES3id. All ATS-2 digital inputs and outputs will work with the data patterns of either the AES3/IEC60958-4 professional format or the IEC60958-3 consumer format. Output format is selectable in software.

We will use the AES3 professional standard as a model for this discussion. For the purposes here, only the Status Bits interpretation is different for the consumer format.

Bi-phase Mark Encoding

To carry a consistent clock and provide for a robust transmission signal, the interface data is processed by bi-phase mark encoding. This scheme provides a transition at the beginning of every data bit, and a second transition in the center of the bit if the bit is a data “1.” Bi-phase mark encoding ensures that there is at least one transition for each data bit, no matter the state of the bit or the state of neighboring bits.

The bi-phase mark pattern is broken for the three types of preambles, as a means of identifying the frame, subframe and block beginnings.

The Frame and Subframe

Figure 288 shows the AES3 data pattern. The *frame* is the basic subunit, and is comprised of two *subframes*, called *subframe A* and *subframe B*. The frame rate is normally the same as the sample rate: a signal sampled at 44.1 kHz will normally be carried on an interface signal running at 44,100 frames per second.

Each subframe carries one word of audio. Normally subframe A will carry a word of audio A, nominally the left channel; subframe B usually carries audio B, the right channel. Other assignments may be made, though, and in dual connector operation both subframes A and B may be subsequent words of the same audio channel, with the second channel carried on the second connector. In multitrack applications, subframes A and B may carry audio channels 7 and 8, for example.

Each subframe has the following structure:



Figure 289. The AES3 frame.

First there is a *preamble*, which has a length of 4 data bits. The preambles are used for identification and synchronization of the frames and subframes. The X preamble indicates the subframe A beginning, the Y preamble indicates subframe B, and the Z preamble indicates subframe A and the beginning of the Channel Status and User blocks.

Following the preamble are 24 bits reserved for the audio word; with shorter audio words the remaining bits are unused, although bits 4–7 can

be re-assigned as *auxiliary bits*. The audio word is arranged with the least significant bit (LSB) first.

After the audio word are four administrative bits, the V bit (Validity), the U bit (User), the C bit (Channel Status) and the P bit (Parity).

The V bit and the P bit carry data which apply only to their particular subframe. If the V bit is 1, the audio data in that subframe is marked as invalid. The P bit is set to 1 or 0 so that even parity is established within the subframe.

The C and U bits do not carry information about one particular subframe; instead, these bits are gathered together in blocks of 192 bits. The block beginnings are identified by the Z preamble.

The C bits and the U bits are gathered separately into the Channel Status block and the User block. Although Status and User blocks built by subframes A and B usually contain the same information, it is possible to carry different Status or User data in the A and B subframes.

ATS reads and sets all Channel Status conditions, but does not display or set User bits.

Channel Status

The Channel Status information differs substantially between the professional and the consumer formats. The first bit in the block indicates professional format by a 0 and consumer format by 1.

The following tables show the channel status fields and their interpretations for both the professional and consumer formats.

Byte		Consumer format channel status fields						
0	Pro/con = 0	Non-audio = 0	Copyright	Emphasis			Channel status mode = 00	
	bit 0	1	2	3	4	5	6	7
1	Category code							
	bit 8	9	10	11	12	13	14	15
2	Source number			Channel number				
	bit 16	17	18	19	20	21	22	23
3	Sampling frequency			Clock accuracy				
	bit 24	25	26	27	28	29	30	31
4	Word length			(Future original sampling frequency?)				
	bit 32	33	34	35	36	37	38	39
5-23	Reserved							
	bits 40-191							

Consumer format channel status field interpretations																																										
Bits	label	interpretation																																								
0	pro/con	0: consumer; 1: professional format																																								
1	non-audio	0: suitable for conversion to analog audio using linear PCM 1: not suitable																																								
2	copyright	0: asserted; 1: not asserted																																								
3–5	emphasis	000: Emphasis not indicated 100: emphasis—CD-type																																								
6–7	channel status mode	00: mode zero; other values reserved																																								
8–15	category code	<p>The category code depends on the equipment type. For most codes the MSB of the category code carries information about generation status of the material (refer to SCMS), and is called the L-bit. The following are common codes:</p> <table border="0"> <tr> <td></td> <td style="text-align: right;">LSB</td> <td style="text-align: right;">MSB</td> </tr> <tr> <td>General</td> <td style="text-align: right;">0000</td> <td style="text-align: right;">000L</td> </tr> <tr> <td>Laser-Optical</td> <td style="text-align: right;">100x</td> <td style="text-align: right;">xxxL</td> </tr> <tr> <td>D/D Converter</td> <td style="text-align: right;">010x</td> <td style="text-align: right;">xxxL</td> </tr> <tr> <td>Magnetic</td> <td style="text-align: right;">110x</td> <td style="text-align: right;">xxxL</td> </tr> <tr> <td>Digital Broadcast</td> <td style="text-align: right;">001x</td> <td style="text-align: right;">xxxL</td> </tr> <tr> <td style="text-align: center;">and</td> <td style="text-align: right;">0111</td> <td style="text-align: right;">xxxL</td> </tr> <tr> <td>Musical Instrument</td> <td style="text-align: right;">101x</td> <td style="text-align: right;">xxxL</td> </tr> <tr> <td>DVD</td> <td style="text-align: right;">1001</td> <td style="text-align: right;">100L</td> </tr> <tr> <td>Present A/D Converter</td> <td style="text-align: right;">0110</td> <td style="text-align: right;">0xxL</td> </tr> <tr> <td>Future A/D Converter</td> <td style="text-align: right;">0110</td> <td style="text-align: right;">1xxL</td> </tr> <tr> <td>Solid State Memory</td> <td style="text-align: right;">0001</td> <td style="text-align: right;">xxxL</td> </tr> <tr> <td>Experimental</td> <td style="text-align: right;">0000</td> <td style="text-align: right;">001L</td> </tr> </table>			LSB	MSB	General	0000	000L	Laser-Optical	100x	xxxL	D/D Converter	010x	xxxL	Magnetic	110x	xxxL	Digital Broadcast	001x	xxxL	and	0111	xxxL	Musical Instrument	101x	xxxL	DVD	1001	100L	Present A/D Converter	0110	0xxL	Future A/D Converter	0110	1xxL	Solid State Memory	0001	xxxL	Experimental	0000	001L
	LSB	MSB																																								
General	0000	000L																																								
Laser-Optical	100x	xxxL																																								
D/D Converter	010x	xxxL																																								
Magnetic	110x	xxxL																																								
Digital Broadcast	001x	xxxL																																								
and	0111	xxxL																																								
Musical Instrument	101x	xxxL																																								
DVD	1001	100L																																								
Present A/D Converter	0110	0xxL																																								
Future A/D Converter	0110	1xxL																																								
Solid State Memory	0001	xxxL																																								
Experimental	0000	001L																																								
16–19	source number	(bit 16 is LSB)																																								
20–23	channel number	(bit 20 is LSB)																																								
24–27	sampling frequency	0000: 44.1 kHz 0100: 48 kHz 1100: 32 kHz xxxx: 24 kHz xxxx: 22.05 kHz xxxx: 192 kHz xxxx: 176.4 kHz xxxx: 96 kHz xxxx: 88.2 kHz																																								
28–29	clock accuracy	10: Level I, ±50 ppm 00: Level II, ±1000 ppm 01: Level III, variable pitch shifted																																								
30–31	reserved																																									
32	word length (field size)	0: Maximum length 20 bits 1: Maximum length 24 bits																																								
33–35	word length	if bit 32 = 1 000: not indicated 101: 24 bits 001: 23 bits 010: 22 bits 011: 21 bits 100: 20 bits	if bit 32 = 0 not indicated 20 bits 19 bits 18 bits 17 bits 16 bits																																							
36–39	reserved																																									
40–191	reserved																																									

Byte	Professional format channel status fields							
0	Pro/con = 1	Non-audio	Emphasis		Lock	Sample frequency		
	bit 0	1	2	3	4	5	6 7	
1	Channel mode				User bit management			
	bit 8	9	10	11	12	13	14 15	
2	Use of auxiliary mode sample bits			Source word length		Alignment level		
	bit 16	17	18	19	20	21	22 23	
3	Channel Identification for multichannel application							
	bit 24	25	26	27	28	29	30 31	
4	DARS		Sample frequency (fs)				fs scaling	
	bit 32	33	34	35	36	37	38 39	
5	Reserved							
	bit 40	41	42	43	44	45	46 47	
6	Alphanumeric channel origin data (first character)						= 0	
	bit 48	49	50	51	52	53	54 55	
7	Alphanumeric channel origin data						= 0	
	bit 56	57	58	59	60	61	62 63	
8	Alphanumeric channel origin data						= 0	
	bit 64	65	66	67	68	69	70 71	
9	Alphanumeric channel origin data (last character)						= 0	
	bit 72	73	74	75	76	77	78 79	
10	Alphanumeric channel destination data (first character)						= 0	
	bit 80	81	82	83	84	85	86 87	
11	Alphanumeric channel destination data						= 0	
	bit 88	89	90	91	92	93	94 95	
12	Alphanumeric channel destination data						= 0	
	bit 96	97	98	99	100	101	102 103	
13	Alphanumeric channel destination data (last character)						= 0	
	bit 104	105	106	107	108	109	110 111	
14	Local sample address code (32-bit binary, LSW)							
	bit 112	113	114	115	116	117	118 119	
15	Local sample address code (32-bit binary)							
	bit 120	121	122	123	124	125	126 127	
16	Local sample address code (32-bit binary)							
	bit 128	129	130	131	132	133	134 135	
17	Local sample address code (32-bit binary, MSW)							
	bit 136	137	138	139	140	141	142 143	
18	Time of day code (32-bit binary, LSW)							
	bit 144	145	146	147	148	149	150 151	
19	Time of day code (32-bit binary)							
	bit 152	153	154	155	156	157	158 159	
20	Time of day code (32-bit binary)							
	bit 160	161	162	163	164	165	166 167	
21	Time of day code (32-bit binary, MSW)							
	bit 168	169	170	171	172	173	174 175	
22	reserved				Reliability flags			
					bytes 0-5	bytes 6-13	bytes 14-17	bytes 18-21
	bit 176	177	178	179	180	181	182 183	
23	Cyclic redundancy check character (CRCC)							
	bit 184	185	186	187	188	189	190 191	

Professional format channel status field interpretations			
Bits	label	interpretation	
0	pro/con	0: consumer; 1: professional format	
1	non-audio (or, more accurately, "not linear PCM")	0: audio data is linear PCM samples 1: other than linear PCM samples	
2–4	emphasis	000: Emphasis not indicated 100: No emphasis 110: CD-type emphasis 111: J-17 emphasis	
5	lock	0: not indicated 1: unlocked	
6–7	sampling frequency	00: not indicated (or see byte 4) 10: 48 kHz 01: 44.1 kHz 11: 32 kHz	
8–11	Channel mode (SCDSR = single channel double sample rate)	0000: not indicated (default to 2 ch) 0001: 2 channel 0010: 1 channel (monophonic) 0011: primary / secondary 0100: stereo 0101: reserved for user applications 0110: reserved for user applications 0111: SCDSR (see byte 3 for ID) 1000: SCDSR (stereo left) 1001: SCDSR (stereo right) 1111: Multichannel (see byte 3 for ID)	
12–15	user bit management	0000: no indication 0001: 192-bit block as channel status 0010: As defined in AES18 0011: user-defined 0100: As in IEC60958-3 (consumer)	
16–18	use of aux sample word	0000: not defined, audio max 20 bits 0001: used for main audio, max 24 bits 0010: used for <i>coord</i> , audio max 20 bits 0011: user-defined	
19–21	source word length	000: if max = 20 bits not indicated 001: 23 bits 010: 22 bits 011: 21 bits 100: 20 bits 101: 24 bits	if max = 24 bits not indicated 19 bits 18 bits 17 bits 16 bits 20 bits

Professional format channel status field interpretations (Cont.)		
Bits	label	interpretation
22–23	alignment level	00: not indicated 01: –20 dB FS 10: –18.06 dB FS
24–31	channel identification	if bit 31 = 0 then channel number is 1 plus the numeric value of bits 24–30. if bit 31 = 1 then bits 4–6 define a multichannel mode and bits 0–3 give the channel number within that mode.
32–33	digital audio reference signal (DARS)	00: not a DARS 10: DARS grade 2 (+ / –10 ppm) 01: DARS grade 1 (+ / –1 ppm)
35–38	sampling frequency	0000: not indicated 1000: 24 kHz 0100: 96 kHz 1100: 192 kHz 1001: 22.05 kHz 0101: 88.2 kHz 1101: 176.4 kHz 1111: User defined
39	sampling frequency scaling	0: no scaling 1: apply factor of 1 / 1.001 to value
48–79	alphanumerical channel origin	four-character label using 7-bit ASCII with no parity. Bits 55, 63, 71, 79 = 0.
80–111	alphanumerical channel destination	four-character label using 7-bit ASCII with no parity. Bits 87, 95, 103, 111 = 0.
112–143	local sample address code	32-bit binary number representing the sample count of the first sample of the channel status block.
144–175	time of day code	32-bit binary number representing time of source encoding in samples since midnight
176–183	reliability flags	0: data in byte range is reliable 1: data in byte range is unreliable
184–191	CRCC	00000000: not implemented X: error check code for bits 0–183

Serial Interface Measurements

ATS-2 provides tools to examine and test both the embedded audio signal and the serial interface signal.

ATS monitors and analyzes the embedded digital audio signal using instruments in the Analyzer panel, such as the **Audio Analyzer**, the **Spectrum Analyzer**, the **Multitone Audio Analyzer** and the **Harmonic Distortion Analyzer**. Many interface-related problems can show up as symptoms in these embedded audio measurements.

ATS can also directly monitor the interface signal on the Digital Input/Output (DIO) panel, which provides direct read-out and control of interface configuration, format, voltage, resolution, sample rate, jitter, status bits and more.

A more powerful tool is the Digital Interface Analyzer, available as part of the ATS-2 Performance Upgrade Option.

This option adds an 80 MHz ADC to ATS-2, dedicated to digitizing the interface data stream for DSP analysis, and enables an additional Analyzer instrument, the Digital Interface Analyzer.

With the Digital Interface Analyzer, you can measure and display the interface waveform and spectrum, create an eye pattern, show the jitter waveform and spectrum and display histograms of interface amplitude, interface rate, interface bit width and jitter.

Appendix C

FFTs

The Fast Fourier Transform

The Fast Fourier Transform, or FFT, is a mathematical technique that deconstructs a complex waveform into its component sinewaves. Presented with a segment of data which represents the amplitude vs. time relationships of a complex waveform, an FFT will derive two sets of results: the amplitude spectrum (amplitude vs. frequency) and the phase spectrum (phase vs. frequency) of the signal. This information is sufficient to describe the relationships of the sinewaves which make up the waveform, and with further computation the FFT results can be interpreted for several different types of display.

In ATS, the amplitude spectrum results and the phase spectrum results are stored in a memory area called the Transform Buffer. These results are read and recomputed for the various display options.

Much of the signal analysis in ATS-2 is performed using FFT techniques. The Spectrum Analyzer, the Digital Interface Analyzer, the Multitone Analyzer and the Harmonic Distortion Analyzer all depend on FFTs. The results are usually displayed as frequency-domain spectrum analysis graphs, but with recalculation the same data can be interpreted and displayed in other ways. Also, the acquisition can be displayed in the time domain as “oscilloscope” or “waveform” views.

Real Time vs. Batch Mode

In ATS-2 an FFT does not work in “real time,” with continually updating displays. Instead, a sample of the signal is acquired, then transformed mathematically (the FFT), then processed for display and shown on the

screen. In Audio Precision instruments this is called “batch mode,” since the data is acquired and processed in discrete “batches.”

The Spectrum Analyzer instrument is the most straightforward and flexible of the FFT-based tools in ATS-2, and we will use it as the example of FFT processing throughout this discussion.

Acquiring Data

The first step in performing an FFT is to acquire signal data, which consists of recording a sample of the signal to a special area in ATS-2 memory, called the *acquisition buffer*. ATS-2 has a 256k sample acquisition buffer for each of the two audio channels.

You can specify the amount of memory to be used in an acquisition, in steps from 800 samples to 256k samples; or you can set ATS-2 to have the acquisition buffer length track the FFT *record length*, which is discussed below. The duration of the signal acquired will depend upon the acquisition buffer length and the sample rate of the signal, and can be calculated from this formula:

$$\text{Acquisition Duration} = \frac{\text{Acquisition Length}}{\text{Sample Rate}}$$

At a sample rate of 48 kHz, a 256k acquisition will have a duration of 5.46 seconds.

The FFT Record

The FFT *record* is the section of signal upon which the FFT processing is actually performed. Its length in samples is called the *record length*, or *FFT length*, or *transform length*. The record length must be smaller than or equal to the length of the acquisition.

FFT Bandwidth

The bandwidth of the signal, the sample rate, the record length and the frequency resolution are all related.

As with any digital signal, the bandwidth is limited by the sample rate in this relationship:

$$\text{Bandwidth} = \frac{\text{Sample Rate}}{2}$$

FFT Bin Width

The two results of an FFT consist of amplitude and phase values for a number of frequencies. The number of frequencies is half the number of samples in the FFT record length.

An FFT length of 8 samples would divide the range from DC to half the sample rate into 4 rather wide bands (which are called *bins*), and provide the amplitude and phase values for each of the bins. For more resolution, a greater FFT length is required. An FFT length of 16,384 samples would result in 8,192 bins across the same frequency range.

The *bin width* (also called *line spacing*) is an expression of the frequency resolution of the FFT, and has this relationship to sample rate and record length:

$$\text{Bin Width} = \frac{\text{Sample Rate}}{\text{Record Length}}$$

With an FFT length of 16,384 samples at a sample rate of 48 kHz, the bandwidth of the FFT would be

$$\frac{48 \text{ kHz}}{2} = 24 \text{ kHz.}$$

The bin width would be

$$\frac{48 \text{ kHz}}{16,384} = 2.93 \text{ Hz.}$$

If a frequency-domain amplitude graph were plotted, it would span the range from 0 Hz to 24 kHz and have 8,192 bins, each 2.93 Hz wide. The amplitude of the energy falling within each bin would be plotted. A spectrum graph of a 800 Hz squarewave made with these settings would look like this:

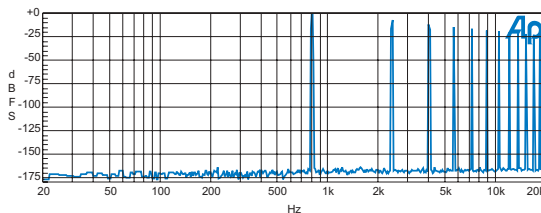

Figure 290. FFT spectrum of 800 Hz squarewave using the Equiripple window.

In this FFT you can clearly see the 800 Hz fundamental followed by the series of odd harmonics which are the components of a squarewave.

FFT Record Looping

The mathematics of FFT processing see the record as an endless loop of signal, just as if the end of the record was “spliced” to the beginning of the record.

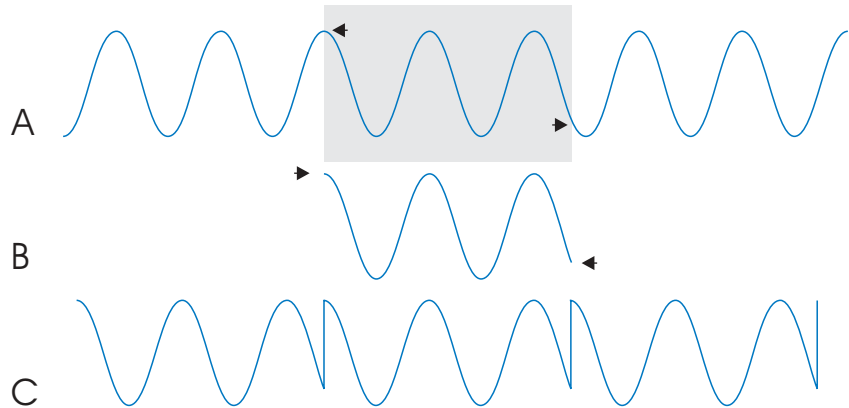

Figure 291. Truncation of non-synchronous waveform.

In audio editing, if there is any difference in the value or slope of the signal at the moment of the splice, there will be a discontinuity or jump in the waveform at that point. An audio edit will “pop” or “click” at such a discontinuity. The same thing happens in FFT processing: the discontinuity, like an audio pop, contains a great deal of energy spread widely over the frequency spectrum. This energy swamps all but the largest signal peaks and produces a useless set of results and a characteristic spectrum.

Figure 292 shows an FFT of a 100 Hz sinewave with a discontinuity in the record loop. Without a way to deal with loop discontinuities, almost all FFTs would look something like this:

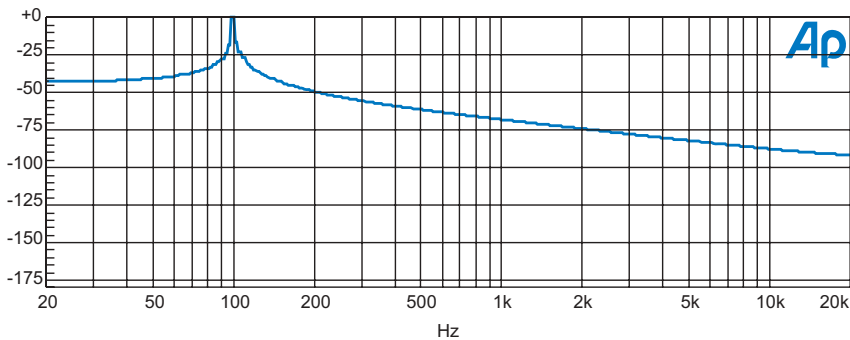

Figure 292. Non-synchronous FFT with no windowing function, 100 Hz sine wave.

Two techniques have been developed to solve this problem. One is FFT windowing; the other is the use of *synchronous* FFTs.

FFT Windowing

Let's return briefly to the audio editing example. The click caused by an abrupt transition can usually be eliminated by making the transition gradual: with a razor blade edit, that means an angled cut; with a computer edit, a brief fade-up or cross-fade is used.

FFT windowing is similar. An amplitude envelope called a *window* is imposed upon the record data before the FFT processing. There are a number of different window shapes with different characteristics, but they all share this feature: they taper at the beginning and end of the record. This means that the two ends of the windowed record data match so that there is no discontinuity and the broadband noise is not introduced.

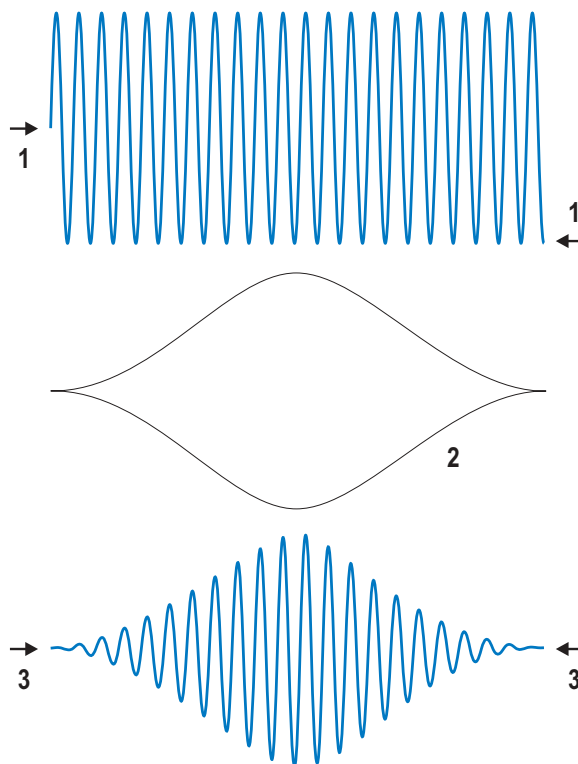

Figure 293. Application of a Hann window function (raised cosine shape) to a sinewave, viewed in the time domain.

The windows *do* modify the acquired signal, however, which is why there are so many to choose from. Windowing spreads the energy in the acquired signal over several bins, and window functions differ in the shape of the resulting spreading. The Flat-Top window, for example, is optimized for flat response at the top of the main lobe, but has poorer resolution of closely-spaced frequencies than other windows; the Hamming window resolves close tones well, but has greater main lobe amplitude error and high side lobes.

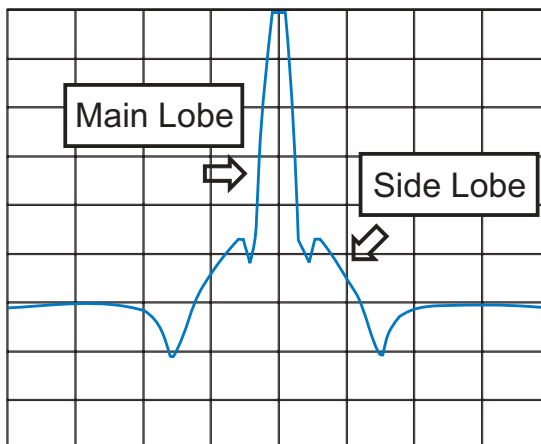

Figure 294. Example of a Blackman-Harris window function viewed in the frequency domain.

See page 161 for illustrations and full descriptions of the FFT windowing functions available with ATS-2.

Synchronous FFTs

Another solution to the FFT looping discontinuity problem is to choose a signal frequency and FFT length such that an integer number of cycles of the signal will exactly fit the record length. When this is accomplished, the beginning and the end of the record will be at adjacent points in the signal, and there will be no discontinuity.

This can only be done when you have precise control of the signal you are using for analysis, and there are many circumstances when that is not possible. But when synchronous FFTs can be used, they bring this great advantage: because the signal has not been modified by a window function, it is unchanged. Energy does not spread across the spectrum, and tremendous low-level detail can be seen. Look at the following four figures, all FFTs of the same 800 Hz sinewave signal:

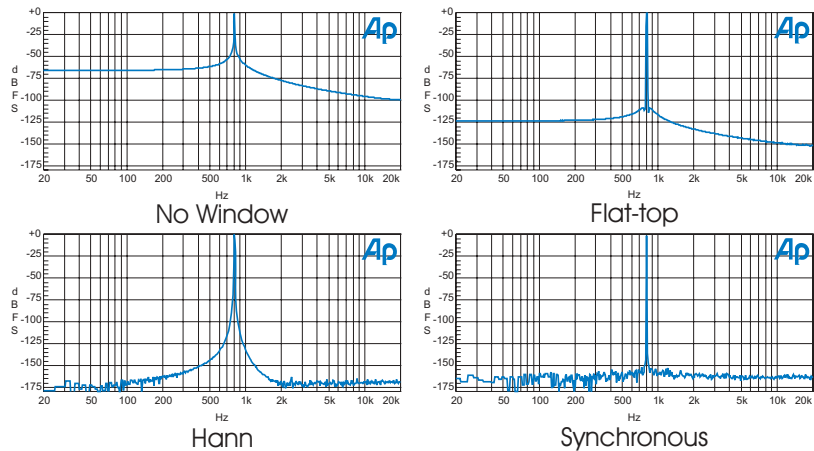

Figure 295. FFTs of 800 Hz sine wave, with no window, Flat Top window, Hann window, and, finally, adjusted very slightly in frequency (to 799.805 Hz) to be synchronous.

Graphing FFTs

ATS-2 FFT results are usually displayed as graphs. In ATS, the number of samples in the record and the number of points or steps requested for the graph not necessarily the same. You can set up an FFT length of only 256 samples and a graph of 5000 steps, or an FFT 32,768 samples long displayed on a graph of only 10 steps.

The FFT length is determined by your frequency resolution needs and the time involved in acquisition. 16,384 samples is a typical choice.

Here are some guidelines to selecting the number of graphed points:

- Use the fewest steps which result in a useful graph. Fewer steps provide faster operation.
- There is no purpose in graphing more points than you have samples; a 128-point FFT graphed at 512 steps will display 384 redundant points.
- If your end use is a graph on a screen or printed on paper, there is no purpose in graphing more points than your monitor or printer can display. Selections of 500 to 1000 points typically provide excellent graphs.
- If your end use is a table, you may want to specify more graph steps than mentioned above, if you have a high-resolution FFT and you would like a detailed table of values.

Appendix D

User Downloadable Filters

Creating User Downloadable Filters

A User Downloadable Filter consists of a properly formatted text file containing information defining the characteristics of the filter. The filter must be named with one of these extensions:

- for a low-pass filter, .afl;
- for a high-pass filter, .afh;
- for a weighting filter, .afw.

As long as the file meets the specifications set out below, you can create the filter by any means, including the use of a text editor or third-party software that has digital filter design capabilities.

User Downloadable Filter Design Constraints:

- Each file specifies a single infinite impulse response (IIR) filter at one or more sample rates.

Each IIR filter can be implemented by cascading one or more second-order sections, shown here:

$$H(z) = \frac{b_0 + b_1 z^{-1} + b_2 z^{-2}}{1 + a_1 z^{-1} + a_2 z^{-2}} .$$

First-order sections are not allowed; a first-order section can be implemented with the second-order section by setting b_2 and a_2 to zero.

- A low-pass filter may not have more than 6 poles or 6 zeros; that is, a low-pass filter can have at most three second-order sections.
- A high-pass filter may not have more than 4 poles or 4 zeros; that is, a high-pass filter can have at most two second-order sections.

- A weighting filter may not have more than 8 poles or 8 zeros; that is, a weighting filter can have at most four second-order sections.
- Unstable filters are not allowed. An unstable filter is a filter with poles on or outside the unit circle on the z-plane.
- Filters with a gain of zero are not allowed. Such filters would result in all zero outputs.
- No coefficient may be greater than 2.0 or less than -2.0.

A simple text file format is used for each user-designed filter. The file format is specified by the following rules:

- All lines starting with # are comment lines.
- Blank lines, that is, lines consisting of zero or more spaces and tabs, are ignored.
- The parameters for filters are specified in a line-oriented fashion, with one entity specified per line.
- Each line has three components: a predefined *keyword*, followed by a *colon*, followed by the *keyword-dependent data*. Any white space surrounding these components is ignored. Three keywords are defined: **info**, **sample_rate**, and **biquad**.
- The **info** keyword specifies a text string of printable ASCII characters to be displayed on the User Downloadable Filters panel when the “**Filter Info**” box is clicked. The **info** comment must be fewer than 1024 characters in length. Only the first **info** keyword found is used; any others are ignored.
- A filter at a given sample rate is specified by the **sample_rate** keyword line followed by one or more **biquad** keyword lines.
- The **sample_rate** keyword is followed by a colon and a floating-point number expressing the sample rate in hertz. There is no limit on the number of sample rates. ATS’s built-in filters are provided at these sample rates:

32000 Hz	44100 Hz	48000 Hz	65536 Hz	88200 Hz
96000 Hz	131072 Hz	176400 Hz	192000 Hz	262144 Hz

Table 4. Sample rates for ATS’s built-in filters.

- The **biquad** keyword is followed by a colon and five floating-point coefficients a_1 , a_2 , b_1 , b_2 , and b_0 in that order, as described in the equation above.

A valid sample file is shown here:

```
info: 100 Hz Butterworth high-pass filter

sample_rate: 32000.0
biquad: -1.9819275 0.9820230 -1.9745094 0.9872547 0.9872547
biquad: -1.9924182 0.9925142 -2.0000000 1.0000000 1.0000000

sample_rate: 48000.0
biquad: -1.9879366 0.9879792 -1.9829700 0.9914850 0.9914850
biquad: -1.9949605 0.9950032 -2.0000000 1.0000000 1.0000000
```

As you can see, a digital filter can be specified by $(5 \cdot N + 1)$ numbers, where N is the number of second-order sections.

User Downloadable Filters can be created by specialized third-party software such as MATLAB, available from The Mathworks, Inc. See **MATLAB Functions**, below, for four MATLAB functions useful in working with downloadable filters and Audio Precision waveform files.

We also provide a filter creation program from Momentum Data Systems called Filter Design Package for Audio Precision (FDP). The software and documentation for FDP are available for download from our Web site at ap.com.

MATLAB Downloadable Filter Support

MATLAB is a technical computing environment used in DSP design and analysis. MATLAB is a product of The Mathworks, Inc., who can be reached at 508-647-7000 or on the Web at <http://www.mathworks.com>.

Two MATLAB functions useful in creating and modifying downloadable filters for use with ATS-2 have been provided as an aid to our customers who also use MATLAB. `ap_write_filter` generates filter files from within MATLAB, and `ap_read_filter` imports such files into MATLAB for further manipulation. These functions are provided as MATLAB files (filename extension “.m”) on the Audio Precision Resources Disc, and are also available on our Web site at ap.com.

ap_write_filter

Syntax

```
size = ap_write_filter(filename,filter_type,info,sample_rate,sos)
size = ap_write_filter(filename,filter_type,info,sample_rate,b,a)
size = ap_write_filter(filename,filter_type,info,sample_rate,z,p,k)
size = ap_write_filter(filename,filter_type,info,sample_rate,a,b,c,d)
size = ap_write_filter(fid,filter_type,info,sample_rate,sos)
size = ap_write_filter(fid,filter_type,info,sample_rate,b,a)
size = ap_write_filter(fid,filter_type,info,sample_rate,z,p,k)
size = ap_write_filter(fid,filter_type,info,sample_rate,a,b,c,d)
```

Description

`ap_write_filter` generates a text file in the format recognized by the downloadable filters feature of ATS. Filters in any of the standard MATLAB forms (second-order section, transfer function, zero-pole-gain, and state-space) can be written to the file, along with the sample rate and textual information.

The AP downloadable filter format consists of one or more sample rates, with accompanying filter coefficients in the form of second-order sections. `ap_write_filter` converts the filter into second-order section form before writing it to the file. This will require functions found in the MATLAB signal processing toolbox if the filter is not already in second-order section form.

`ap_write_filter` accepts both filenames and file handles. If a filename is supplied, any extension is replaced with `.afl`, `.afh`, or `.afw`, depending on the filter type. If the filename ends in `+`, the file is appended to, or created if non-existent. `ap_write_filter` closes the file when the function exits. If a file handle is supplied, `ap_write_filter` appends to the file, leaving it open on exit.

The arguments `filter_type`, `info`, and `sample_rate` are required. `filter_type` is the string `'l'`, `'h'`, or `'w'`, for low-pass, high-pass, and weighting filters respectively. `ap_write_filter` uses this information to determine the filename extension, and to restrict the number of second-order sections to the maximum allowed in the Audio Precision hardware for each filter type. `info` is a character string that can be viewed inside ATS by clicking the **Filter Info** button after loading the filter. This provides filter information to the ATS user. `sample_rate`, a scalar, is the sample rate in hertz for which the filter was designed. See **Multiple Sample Rates** below for more information.

`ap_write_filter` uses the number of remaining arguments to determine whether the filter is supplied in second-order section form, in transfer

function form, in zero-pole-gain form, or in state-space form. The transfer function form is not recommended for large filters because factorization into second-order sections may cause the poles and zeros to move slightly, deforming the filter response.

The total number of bytes written to the file is returned in `size`.

Multiple Sample Rates

A digital filter will have the intended frequency response only at the sample rate for which it was designed. Thus, a unique filter must be designed for each sample rate that will be encountered. If a filter file contains filters for multiple sample rates, ATS chooses the filter coefficients corresponding to the sample rate closest to the current hardware sample rate.

An Audio Precision filter file can contain a filter defined at any number of sample rates. Either a file handle or the file append mode can be used to add filters for other sample rates to an existing file. `ap_write_filter` writes an **info** string for each sample rate; however, ATS will only report the first of these strings.

Filter Restrictions

The number of filter orders is limited to 6 for low-pass filters, 4 for high-pass filters, and 8 for weighting filters. The sample rate must be between 6750 Hz and 262144 Hz. All zeros must be on or inside the unit circle, and all poles must be inside the unit circle. All coefficients must be in the range $[-2,2]$.

Examples

1. Compute a Chebyshev high-pass filter with a corner frequency of 200 Hz and a passband ripple of 0.1 dB for three common sample rates.

```
for sr=[32000 44100 48000]
    [z,p,k]=cheby1(4,0.1,200/(sr/2),'high');
    ap_write_filter('c:\filters\cheby200+', 'h', '200 Hz Cheby highpass',sr,z,p,k)
end
```

We use the zero-pole-gain form for accuracy, and the append mode to attach the three sample rates to the same file.

2. Compute a voice-band boosting filter at two sample rates. Use the file handle method to write to the output file.

```
ofp=fopen('c:\filters\voice.afw','wt');
fprintf(ofp,'# Voice band filter designed in MATLAB by yulewalk\n\n');
for sr=[48000 65536]
    [b,a]=yulewalk(8,[0 500 1000 4000 8000 sr/2]/(sr/2),[0.5 0.5 1 1 0.25
0.25]);
    ap_write_filter(ofp,'w','Voice band filter',sr,b,a)
end
fclose(ofp);
```

Here we have the flexibility to write comments to the output file (preceded by the '#' identifier) which will not appear inside ATS. Note that it is the user's responsibility to create a file with the appropriate extension, and to properly close the file.

ap_read_filter

Syntax

```
[filter_array,info] = ap_read_filter(filename)
[filter_array,info] = ap_read_filter(fid)
```

Description

`ap_read_filter` imports an Audio Precision downloadable filter text file into MATLAB. It parses the file and returns a structure array of filters, one structure for each sample rate contained in the file. It also returns the **info** comment strings. The file is closed on exit.

The AP downloadable filter format consists of one or more sample rates, with accompanying filter coefficients in the form of second-order sections. `ap_read_filter` creates one structure in the output array for each sample rate in the file. Each structure contains the sample rate and a matrix consisting of the filter in second-order section form. If other forms are required, such as state-space, the signal processing toolbox conversion functions should be used.

Comments in the file are discarded, but **info** strings are concatenated into the returned `info` variable. The **info** strings are used by ATS to provide information to the user when the **Filter Info** button is clicked.

`ap_read_filter` attempts to deal with syntax errors in the file by issuing a warning of the line number of the error.

Example

To read the filter file generated by the first example in `ap_read_filter`:

```
[filters,info] = ap_read_filter('c:\filters\cheby200.afw');
```

This returns a 1×3 structure array. Typing `filters(1)` at the prompt returns

```
ans = sample_rate: 32000  
      sos: [2x6 double]
```

The second-order sections can be examined by typing `filters(1).sos` at the prompt.

Appendix E

AP Waveform File Support

Audio Precision waveform files (.aam, .aas, .agm, .ags) are of proprietary format. These files can be created in the ATS environment and saved on disk using the File Menu. Saved files can be opened for insertion in the acquisition buffer, the transform buffer, or either the analog or digital generator arbitrary waveform buffers.

This chapter discusses additional support for working with Audio Precision waveform files. You can export to and import from standard .WAV files, and MATLAB users are provided with functions to write, read and equalize arbitrary waveforms that are in the Audio Precision format.

Exporting to .WAV

The Export WAV File selection provides the capability to export audio data to disk as a Microsoft Windows PCM (.WAV) file, from one of three 2700 Series instrument memory buffers: the Arbitrary Waveform buffer, the Acquisition buffer or the Transform buffer.

Operation

From the Main menu, select **File > Export... > (.wav) File...**

You will be presented with the File Save dialog. Enter a file name and browse to the folder where you would like create the WAV file. Click Save to continue. In a few moments you will be presented with the Export MS (.wav) Waveform dialog.

In the Instrument Source area, select the memory buffer that contains the audio data to be exported. Only memory buffers that contain audio data will be available. If you select the Transform buffer, you can force the length of your exported audio data to match the current record length (set

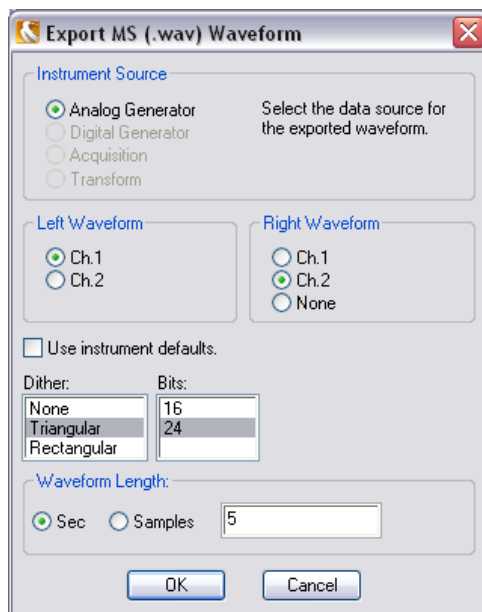

by the FFT length setting) by checking the “User Instrument defaults” checkbox below.

Stereo WAV files contain two audio waveforms, the first for the left channel and the second for the right channel. You can direct the audio data in the buffer channels to either the Left Waveform or the Right Waveform of the WAV file you are creating. If you select None for the Right Waveform, a mono WAV file will be created.

Set your dither preferences in the Dither field. Your choices are None, Triangular dither or Rectangular dither.

Set the resolution (word length) of your exported WAV file in the Bits field. Choose any word length from 8 bits to 24 bits.

Set the length of your exported waveform in the Waveform Length field, in time (seconds) or by number of samples. If the resulting length is less than the record length of the source the waveform is truncated at the end. If the resulting length is longer than the source, the source data is repeated until the specified waveform length is achieved.

Tips and Tricks

When initially acquiring the audio signal, in the FFT Spectrum analyzer panel set Window to “None, move to bin center”. The signal must be a single sine wave.

This selection shifts the frequency of the acquired signal to the nearest FFT bin center frequency, effectively stretching or compressing the signal in time so that the number of waveform cycles in the analyzer transform buffer is an integer. This is called a synchronous waveform, and no windowing function is necessary for useful FFT analysis.

After the acquisition is completed, export the data in the Transform buffer using this Add-In, and selecting the “Transform” Instrument Source selection. The resulting Windows PCM (.wav) file is synchronous and can be imported into the Analog or Digital generators as an Arbitrary waveform.

Importing from .WAV

The Import (.wav) File selection provides the capability to import audio data from a Microsoft Windows PCM (*.wav) file on disk into one of three 2700 Series instrument memory buffers: the Arbitrary Waveform buffer, the Acquisition buffer or the Transform buffer.

Operation

From the Main menu, select **File > Import... > (.wav) File...** You will be presented with the File Open dialog. Browse to the file you would like to import. Click Open to continue. In a few moments you will be presented with the Import MS (.wav) Waveform dialog.

In the Instrument Destination area, select the memory buffer where the audio data will be stored: the Arbitrary Waveform buffer for the Analog or Digital Generator, the Acquisition buffer or the Transform buffer. If there is currently data in the Arbitrary Waveform buffer, the “Update current generator file” checkbox will be available, and you must check the box to overwrite the current data.

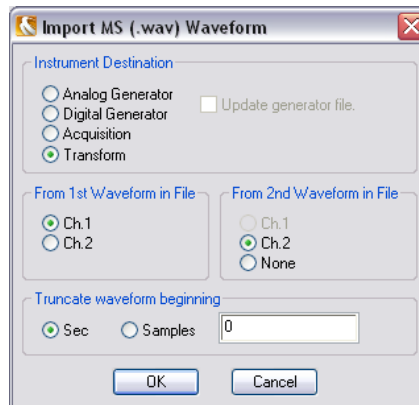

Stereo WAV files contain two audio waveforms, the first for the left channel and the second for the right channel. You can direct these waveforms to the buffer memory channels using the buttons in the “From 1st Waveform in File” and “From 2nd Waveform in File” areas. If you are importing a mono WAV file, the “2nd Waveform in File” options are not available.

In some cases, the beginning of a WAV file may contain audio that is undesirable for measurement. In the “Truncate waveform beginning” field, you can enter the length of the initial audio to exclude. Enter the length in time (seconds) or by specifying the number of samples.

Click OK. The audio data will be imported into the selected buffer.

MATLAB support

MATLAB is a technical computing environment used in DSP design and analysis. MATLAB is a product of The Mathworks, Inc., who can be reached at 508-647-7000 or on the Web at <http://www.mathworks.com>.

Two MATLAB functions supporting Audio Precision formatted wave files for use with ATS-2 have been provided as an aid to our customers who also use MATLAB. `ap_write_wave` generates AP wave files from within MATLAB, and `ap_read_wave` imports such files into MATLAB for further manipulation. These functions are provided as MATLAB files (file-name extension “.m”) on the Audio Precision Resources Disc, and are also available on our Web site at ap.com.

ap_write_wave

Syntax

```
size = ap_write_wave(filename, sample_rate, normalize, data)
size = ap_write_wave(fid, sample_rate, normalize, data)
```

Description

`ap_write_wave` generates a binary waveform file that can be loaded into Audio Precision hardware. Files with extensions .agm (mono generator waveform) and .ags (stereo generator waveform) are supported.

The AP waveform file format consists of a 256-byte header containing sample rate and other information, and a $3n$ -byte payload, where n is the number of samples in the waveform. Each sample is quantized to 24 bits and is in the range $[-1, 1-2^{-23}]$.

`ap_write_wave` accepts both filenames and file handles. If a filename is supplied, any extension is replaced with `.agm` or `.ags`, depending on the size of the data matrix. `ap_write_wave` closes the file when the function exits. If a file handle is supplied, `ap_write_wave` appends to the file, leaving it open on exit.

`sample_rate`, a scalar, is the sample rate of the waveform in hertz.

If `normalize` is 1, the data is scaled so that the peak of the waveform reaches full scale. The data is also dithered before reducing the word size to 24 bits. This preserves low-level information and eliminates harmonic distortion due to quantization. This mode is recommended unless multiple waveforms are being generated whose amplitude relative to one another is important.

If `normalize` is 0, the data is written to the file unscaled. If any samples are outside the allowable range, they are clipped and a warning is issued.

`data` is a matrix containing the waveform. If the smaller dimension is 1, a mono waveform file is generated. If it is 2, a stereo waveform file is generated. Any other size will generate an error.

Example

At a sample rate of 40 kHz, create a sinewave of approximately 1 kHz in channel A and noise in channel B. The length is 2048 samples.

```
len=2048;
samp_num=0:len-1;
samp_rate=40000;
ch_A=sin(samp_num/len*2*pi*round(1000/samp_rate*len));
ch_B=randn(1,len);
ap_write_wave('c:\waveforms\sin_noise',40000,1,[ch_A; ch_B])
```

This generates a file `sin_noise.ags`. The actual frequency of the sinewave is 996.094 Hz. This is a frequency that is synchronous with the sample rate and the waveform length. That is, when the waveform is repeated, there are no discontinuities.

ap_read_wave

Syntax

```
waves = ap_read_wave(filename, system)
waves = ap_read_wave(fid, system)
waves = ap_read_wave(filename)
waves = ap_read_wave(fid)
```

Description

`ap_read_wave` imports an Audio Precision waveform file into a MATLAB structure array. One structure is created for each waveform in the file. Files with extensions `.aam` (mono acquired waveform), `.aas` (stereo acquired waveform), `.agm` (mono generator waveform), and `.ags` (stereo generator waveform) are supported. The file is closed on exit.

When reading an acquired file (`.aam` or `.aas`), the case-insensitive parameter `system` must be supplied to scale the results correctly. Choices for `system` are:

- 'ATS2' for ATS-2
- 'S1' for System One
- 'S2' for System Two
- 'S2C' for System Two Cascade

If the wrong `system` is supplied, the results will be unpredictable. When reading a generator file (`.agm` or `.ags`), `system` is not required.

Each structure consists of a sample rate, a trigger point, a time vector, and the waveform vector. The sample rate and trigger point are determined from the header information in the waveform file.

For acquired waveforms, the trigger point is the sample at which the trigger occurred during acquisition. For generated waveforms (such as arbitrary waveforms created by the Multitone Creation utility in ATS-2), the trigger point is usually zero. The time vector is constructed from the trigger point, the total number of points in the waveform, and the sample rate. The data vector consists of the file payload converted to `double`.

If `ap_read_wave` determines that the file contains data acquired from an analog source, it attempts to scale the data so that the value of a sample represents the analog voltage at that time. Because some gain constants are known only to the hardware on which the waveform was acquired, however, this will only be approximate. Data originally from a digital source is not scaled.

Example

Read the .ags file generated by the `ap_write_wave` example.

```
waves=ap_read_wave('c:\waveforms\sin_noise.ags');
```

This returns a 1×2 structure array. Typing `waves(1)` at the prompt returns

```
ans = sample_rate: 40000  
      trigger_point: 0  
           time: [2048x1 double]  
           data: [2048x1 double]
```

The data can now be examined:

```
figure(1), plot(waves(1).time,waves(1).data)  
figure(2), plot(waves(2).time,waves(2).data)
```

Appendix F

Test and Macro Translators

The ATS control software includes the capability of translating tests created in APWIN for System One, System Two and System Two Cascade instruments into ATS test files. The Test Translator description begins below.

Additionally, AP Basic macros (called *procedures* in APWIN documentation) can be translated from their original form into ATS macros. See page 422 for a description of the Macro Translator.

Not all features on these other Audio Precision instruments exist in ATS-2, and some features common to all platforms are implemented differently in ATS-2. For these reasons some tests and macros, although translated correctly and mapped to compatible functions, will still need editing or reconfiguration to accomplish their original purpose.

NOTE: Test files created in AP2700 for 2700 series instruments cannot be translated into ATS tests.

Check the Web!

The latest updates and hints for both the ATS-2 Test Translator and the Macro Translator are available at the Audio Precision Web site at ap.com.

The Test Translator

When preparing tests for translation on a System One, System Two or System Two Cascade, we strongly recommend that you upgrade to the latest version of APWIN (currently version 2.24) for test creation.

The ATS-2 translator can convert the test types listed in the following table into ATS-2 tests:

Instrument	Test file filename extension
System One (DOS)	.tst
System One (APWIN)	.at1
System Two	.at2
System Two Cascade	.at2c

System Two Cascade tests can be imported directly into ATS. System One and System Two tests must first be converted to Cascade tests, as described below.

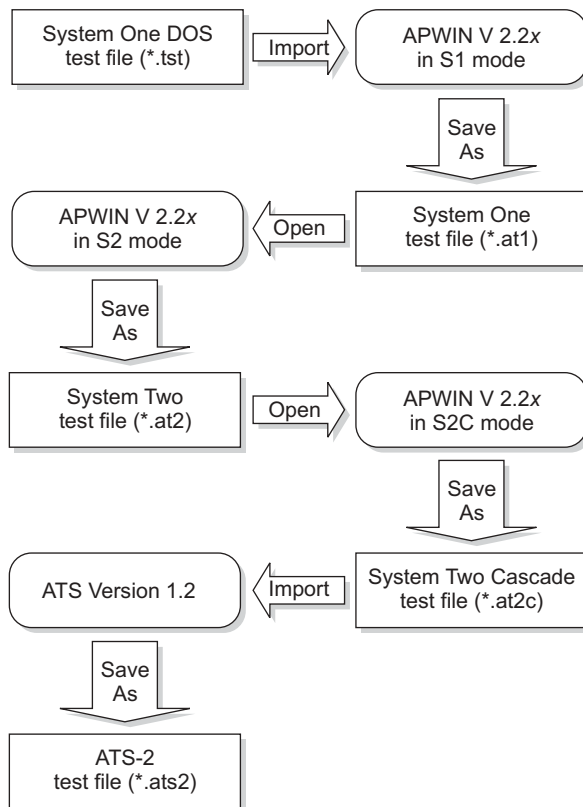

Figure 296. Preparing a test file for translation from S1.EXE or APWIN to an ATS-2 compatible test file.

Preparing S1.EXE and APWIN tests for translation

To be compatible with the ATS-2 Test Translator, S1.EXE and APWIN tests must be saved as System Two Cascade (or Cascade *Plus*) tests, file-name extension “.at2c”. Tests may be saved from any Cascade-compatible version of APWIN up through version 2.24.

We strongly recommend that you upgrade to the latest version of APWIN (currently version 2.24) to prepare tests for translation.

Tests created in System One or System Two must be opened and re-saved at the next instrument level in a step-by-step process until the test is saved as a Cascade test. You cannot, for example, open a System One test and save it as a Cascade Test. You must first open the file in APWIN running in System Two mode and save it as a System Two test. Then you must open that file in APWIN in Cascade mode, and re-save the test as a Cascade test. See the diagram in Figure 296 for an illustration of the complete test migration flow for all instruments and software.

You do not need to have System One, System Two or System Two Cascade hardware connected to your computer to import, open or save test files as described. These conversions can be performed while APWIN is running in Demo Mode.

DON'T run the ATS software while APWIN is running in Demo Mode.

Macros for batch converting APWIN tests

Multiple System Two Cascade tests can be imported into ATS in one translation operation. You can select all the *.atc2 test files in a directory for batch conversion, as is discussed in the next section.

However, moving multiple older test files up the APWIN migration path shown in Figure 296 can be a slow process, limited by APWIN's constraint of being able to open and save only one test file at a time. To address this issue, Audio Precision's technical support team have written macros that automate batch loading and saving of APWIN tests. You can download these macros and find other information for the ATS-2 Test and Macro Translators at our Web site at ap.com.

Using the ATS-2 Test Translator

Figure 297. Importing an APWIN test.

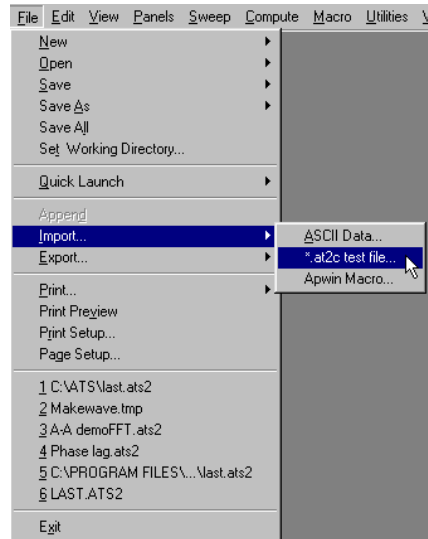

The ATS-2 Test Translator appears as an additional menu selection in the ATS File menu. Choose **File > Import > *.at2c test file...** to open a file browser for translation. See Figure 298. Navigate to the appropriate folder and select the test file you want to translate.

If you select only one file, that test will be imported, loaded into memory and saved as an ATS-2 test. If you select multiple files, all the selected files will be translated in a batch. Each file will be first loaded into memory and then saved; the last file opened will remain in memory.

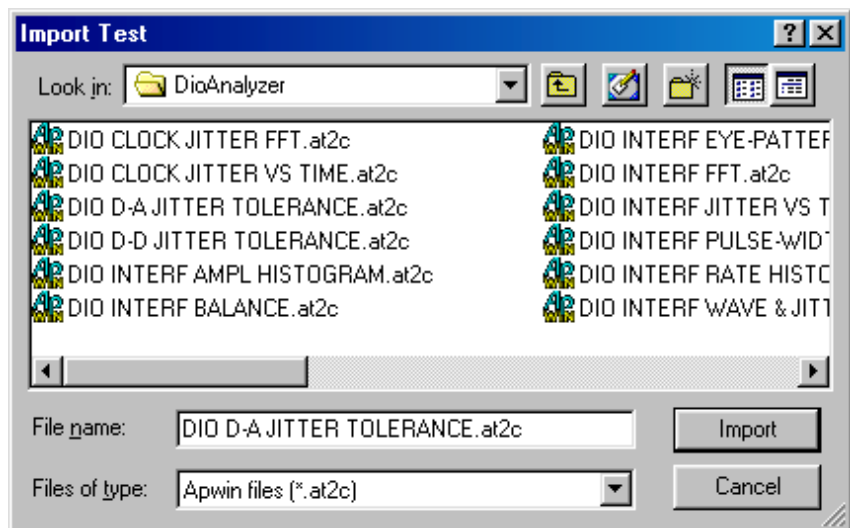

Figure 298. Selecting APWIN test(s).

Test files will be saved with their original filenames, but the filename extension will be changed to “.ats2,” the ATS-2 test filename extension.

You should NOT import an .at2c file into ATS in Demo Mode. Instead, have your ATS-2 hardware powered on and connected to your computer so that the software will be informed of the ATS-2 hardware options that are installed in your system and will configure the imported test accordingly.

How the Test Translator Makes Decisions

The Test Translator will correctly convert the vast majority of control settings and readings from APWIN tests to ATS tests. APWIN controls that are the same as ATS controls are mapped to those controls; APWIN controls that have similar counterparts in ATS are mapped to the best match or to a default; APWIN controls that have no counterpart in ATS are discarded.

Many tests will function as designed with no additional input, and many others will only require minor changes. However, the great differences in system architecture mean that some controls, settings, or readings simply will not translate. Some testing strategies may require a new approach that makes the best use of the features on ATS-2.

We recommend that you have a solid understanding of the architecture and features of both ATS-2 and the System in which the original test was created, and that you review the purpose and the approach of each test candidate for translation. When the translation is completed, carefully check the converted test to be sure the settings, readings and operation are what you expected. It may be valuable to compare the results produced by the test on its original instrument, and on ATS-2.

Mapping Two Analyzers into One Analyzer

System Two Cascade has dual analyzers, one analog and one digital. ATS-2 has one analyzer that must be switched between analog and digital domains. This means that in any test, only one Cascade analyzer can be mapped to the ATS-2 analyzer. This decision is made on the basis of the settings saved in the test’s Bar Graph or Sweep panel settings, since these reflect the way the test creator was using the instrument. These rules are used:

- If all the Bar Graphs in the Cascade test are attached to Cascade’s Analog Analyzer, the Analog Analyzer controls will be mapped to the ATS-2 Audio Analyzer.
- If all the Bar Graphs in the Cascade test are attached to Cascade’s Digital Analyzer, the Digital Analyzer controls will be mapped to the ATS-2 Audio Analyzer.

- Bar Graphs that are attached to neither Analyzer are not considered.
- If no Bar Graphs are attached to either Analyzer, or if Bar Graphs are attached to both Digital and Analog Analyzers, the translator will check the Cascade Sweep panel **Data 1** field. If **Data 1** is attached to the Analog or Digital Analyzer, the controls of that Analyzer will be mapped to the ATS-2 Analyzer controls.
- If **Data 1** is not attached to either Analyzer, the translator will continue checking **Data 2** through **Data 6** in a similar fashion.
- If no Bar Graph or Sweep **Data** field indicates an Analyzer domain, the Cascade Analog Analyzer will be mapped to the ATS-2 Analyzer.

Attached file considerations

The filename extensions for attached files are different between APWIN and ATS. The Translator detects these situations and makes copies of the attached files using the same filename and path, but using the ATS file-name extensions. The attachment points in the ATS test will be changed to refer to the copied and renamed files.

Reporting Test Translation Exceptions

The Test Translator will report the following conditions to the ATS log file:

- Tests containing Bar Graph and Sweep settings that had references to both Cascade Analog and Digital Analyzers and therefore could not be mapped to the single ATS-2 Analyzer.
- Settings that cannot be mapped because they are out-of-range for the ATS-2. Such settings are set to default values.
- Tests calling for a selection that is not available in ATS, and no substitute is available that will result in proper operation. The closest available substitution will be made, but it is likely that you will need to make changes to the test.

In general, features that do not exist in ATS-2 and therefore can never be mapped will *not* be reported, since these conditions will occur in every test translation.

The Macro Translator

Unlike the binary test files, AP Basic macro files contain text that can be viewed and edited. This makes it easier for you to check a translated macro and make changes if necessary.

Macros from System One, System Two and System Two Cascade can be directly translated for ATS-2 without intermediate conversions. However, it is helpful to the translation to identify the System for which the macro was written. See **Identifying the System when Importing Macros** on page 424.

The heart of the Macro Translator is a search-and-replace algorithm, which means that there are some limitations to the inferences it can make. Where possible, the translator will substitute ATS-compatible commands for the existing APWIN commands.

Using the Macro Translator

Figure 299. Importing an APWIN macro (procedure).

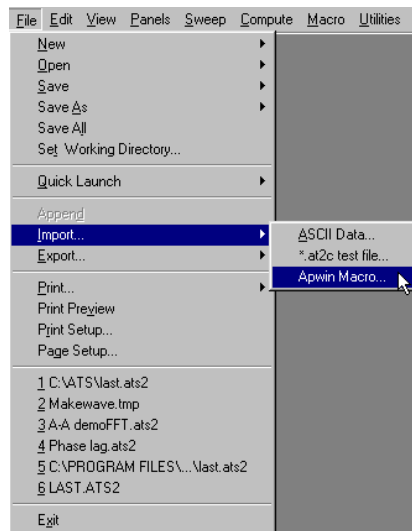

The ATS-2 Macro Translator appears as an additional menu selection in the ATS File menu. Choose **File > Import > APWIN Macro...** to open a file browser for translation. Navigate to the appropriate folder and select the macro file you want to translate.

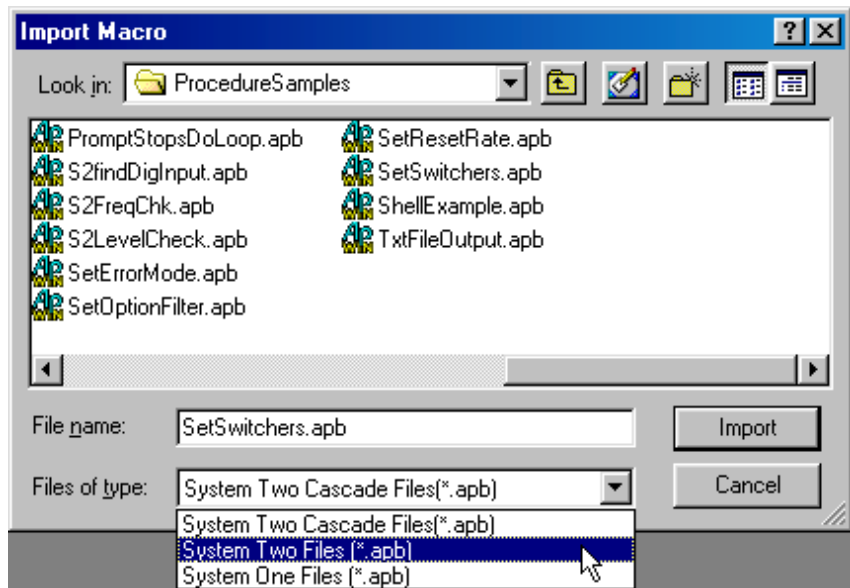

Figure 300. Selecting APWIN macro(s) (procedures).

If you select only one file, that macro will be translated and saved and then loaded into the Macro Editor. If you select multiple files, all the selected files will be translated and saved in a batch; the last macro saved will be loaded into the Macro Editor.

Each file will be saved with its original filename, but the filename extension will be changed to “.atsb,” the ATS-2 macro filename extension.

Identifying the System when Importing Macros

Commands in AP Basic can have different effects on the three Audio Precision “System” instruments, and for correct macro translation it is helpful if the Translator software knows for which System the original procedure was intended. Select the System type from the “Files of type:” drop-down list as shown in Figure 300.

Macro Translator Issues

Decisions made in macro translation are based on the same platform differences that determine test translation decisions. **Mapping Two Analyzers into One Analyzer** (page 421) describes the actions taken by both the Test Translator and the Macro Translator in attempting to map the Audio Analyzer. There are a few issues that only apply to macro translation, however, that follow here:

Numbers or Constants?

ATS commands use language-defined constants for many arguments and return values, where APWIN commands used numbers. If the implementation is a simple assignment or comparison (such as “AP.Anlr.ChAInput=0”), then the translator can make the proper substitution (e.g. “ATS2.AnalogIn.Source(apbChA) = apbAnalogInXLR_Bal”aaa). However, the user may have assigned a variable to the number and then used the variable in the assignment or comparison. In these situations, the translator has no way of knowing where the assignment may have been made or the number calculated, so user intervention is required to rework the code. These situations are flagged with a comment indicating that the command has been changed to use constants instead of numbers.

Libraries and the “With” Command

There are some potential problems in using the “With” command. Some commands, though equivalent, have been repartitioned into different libraries, so a different “With” command would be required to precede them. The translator will take its best guess at the appropriate string for the “With,” command, and will flag it with a comment. Some may need to be changed to reference a different library, and in some cases multiple “With” commands may be needed.

Referenced Files

As the Macro Translator finds commands in the imported procedure that reference an external file whose extension must change between APWIN and ATS, it will copy the referenced file with the same name and path but with the new ATS filename extension, and modify the macro command to reference the copied file.

For example, if the imported procedure references a file named “MyLimits.adl”, the Macro Translator will copy the file to “MyLimits.atl” and will change the reference within the translated macro to the new filename.

Unavailable Features

Commands which reference features that are not available in ATS-2 are flagged. If there is a reasonable substitution, it will be made; if not, the command will be commented out.

Reporting Macro Translation Exceptions

Like the Test Translator, the Macro Translator reports activity to the Log File. However, most macro translation notes appear as comments within each translated macro file. When the translator detects situations that re-

quire user attention, a comment will be placed in the code preceding the line or lines of code that need to be examined. The comments inserted by the translator all begin with two asterisks (**) so that they can be easily found. When multiple subsequent lines all have the same comment, the comment is placed only once at the beginning of the code block.

The translator also puts comments at the beginning of each macro to indicate that it was translated from an APWIN procedure, and to log the date of the translation.

These comments within the AP Basic script can help you to understand the translation process and debug the macro, if necessary.

Mapping exceptions and substitutions

Following is a list of Test and Macro Translation mapping exceptions, substitutions, and other issues that may need to be addressed by the user.

Most of the mapping exceptions are the same for both test and macro translation. Differences in handling between the two translators are noted within the listing.

Analog Generator

- The Cascade Analog Generator primary waveform selections are mapped to equivalent analog waveforms generated in the digital domain in ATS.
- MLS is not support by ATS-2; MLS selections are substituted with “Sine Normal.”
- “Normal Burst,” “Triggered Burst” and “Gated Burst” are not supported by ATS. All of these settings are mapped to “Shaped Burst,” which is the closest available waveform.
- “CCIF/DFD,” “DIM 30,” “DIM 100,” “DIM B” IMD waveforms are not supported by ATS. These are mapped to “SMPTE/DIN 1:1.”
- The “Pink” noise waveforms are not supported in ATS. All “Noise” and “Noise (D/A)” waveforms (including the true random white noise of the BUR-GEN option) are mapped to the ATS “Noise” waveform, which is only available as pseudo-random white noise.
- Depending on the options installed, certain output impedances may not be supported for ATS-2 balanced outputs. In APWIN, three balanced output impedances are available: 40 Ω (50 Ω in System One), 150 Ω (or 200 Ω with the EURZ option), and 600 Ω . In ATS-2, only two choices are available: low (40 Ω) or high (150 Ω , or optionally 200 Ω or 600 Ω). 40 Ω or 50 Ω are always mapped to

40 Ω . Any of the higher impedances are mapped to the whichever high impedance selection is available in ATS-2. Unbalanced output impedances are mapped low-to-low, high-to-high.

Test Trans: A message will be generated in the log file if the original impedance does not match the translated impedance.

Macro Trans: The higher impedances are mapped assuming that the appropriate hardware option is available. If the option is not installed, this will cause an error at run time.

- ATS-2 does not have transformer-coupled outputs. APWIN settings that specify ungrounded 'Float' configurations will be mapped to the standard ATS-2 output configurations, which are grounded.

Digital Generator

- MLS is not supported by ATS; MLS selections are substituted with "Sine Normal."
- "CCIF/DFD" and "DIM" IMD waveforms are not supported by ATS. These are mapped to "SMPTE/DIN 1:1."
- "Pink" and "USASI" noise waveforms are not supported. "Noise" is used, which in ATS available only as pseudo-random white noise.

Audio Input

The functions in the APWIN Digital Analyzer panel Input selection control are split into two controls for ATS. The ATS-2 Analyzer panel retains the choice between "Analog" and "Digital" inputs; the converter and sample rate selections are on the ATS Analog Input panel.

- If the Digital Analyzer is being mapped, the translator selects Analog or Digital Input and the converter and sample rate based on the Cascade Digital Analyzer's Input setting control.
- **Test Trans:** If the HiBW converter was selected for Cascade but the Performance Option is not installed in ATS-2, the default HiRes converter will be substituted.
Macro Trans: If the HiBW converter was selected for Cascade, it is mapped assuming that the Performance Option hardware is available. If the option is not installed, this will cause an error at run time.
- If a Digital Input mode was selected for Cascade, the ATS Analyzer panel is set to "Digital" and the Analog Input Panel is set to "HiRes @ 65536."

- If the Analog Analyzer is being mapped, “Analog” will be selected on the ATS Analyzer, and the Analog Input panel is set to “HiRes @ 65536.”

ATS-2 has bandwidth limitations that do not exist in System One and System Two. Band-limited readings in ATS-2 may differ from System One or System Two readings. No notice of the possibility of such differences will be written to the log file.

- The analog input source selections on the Digital Analyzer are quite different between System Two and ATS-2, and not every case can be mapped correctly. APWIN allowed each channel to select among a variety of input sources that included points within the Analog Analyzer signal path and also the recovered jitter signal. In ATS-2 the input sources are always the front panel inputs. All APWIN Digital Analyzer sources are mapped to these ATS-2 inputs.
Test Trans: If remapping of incompatible source selections occurs, a message will be written to the log file.
Macro Trans: If remapping of incompatible source selections occurs, the incompatible source selections are commented out.
- Most of the APWIN FFT Analyzer sources are not supported in ATS. Digital and analog inputs are mapped correctly, as is the recovered jitter signal for analysis channel B. Other sources will be mapped to Analog inputs. If incompatible source selections were in the APWIN test, a message will be written to the log file.
- Depending on the options installed, certain input terminations may not be supported for ATS-2 inputs. In APWIN, three balanced input terminations are available: 300 Ω , 600 Ω and >100 k Ω . In a standard ATS-2, only >100 k Ω is available. The 600Z option adds an additional input termination choice of 600 Ω .
Test Trans: If the ATS-2 does not have the 600Z option installed, all input termination choices will be mapped to >100 k Ω . If 600Z is installed, >100 k Ω will be mapped to >100 k Ω , and 300 Ω and 600 Ω will be mapped to 600 Ω . A message will be generated in the log file if the original input termination does not match the translated input termination.
Macro Trans: >100 k Ω will be mapped to >100 k Ω , and 300 Ω and 600 Ω will be mapped to 600 Ω . If the 600Z Option is not installed, this re-mapping will cause an error at run time.

Analyzer Settings

- Any commands that references the Analog or Digital Analyzer in Cascade are mapped to reference the one Analyzer in ATS. This can

be a problem for the user if both Analyzers are referenced in the code—the result may be an incomprehensible mix of Analyzer commands.

- The System Two Cascade Analog Analyzer has only one analysis channel, which is switched between channel A and channel B inputs. The ATS-2 analyzer has two full analysis channels. When translating these situations, the translator software has no way of knowing which channel the Analyzer was set to, and therefore doesn't know which ATS-2 Analyzer channel is referenced.

Test Trans: APWIN Analog Analyzer references are mapped to ATS-2 Analyzer Channel A and a message is written to the log file.

Macro Trans: APWIN Analog Analyzer references are mapped to ATS-2 Analyzer Channel A and flagged with a comment.

- “Bandreject” function is not supported in ATS. It is substituted with “THD+N Ampl.”
- “CCIF,” “DIM,” “Wow & Flutter,” and “DFD” measurement modes are not supported in ATS. These are substituted with “Amplitude” mode.
- Cascade has both “Auto-Fast” and “Auto-Precise” modes for automatic selection of detector reading rate. ATS has only one “Auto” automatic selection mode, so it is used for both of these cases.
- “Average,” “Peak,” and “S-Peak” (Peak-Equivalent-Sine) detectors are not supported in ATS. These are mapped to “RMS.”
- Bandwidth Lowpass settings have changed. “22 kHz” in Cascade is substituted with “20 kHz” in ATS. Cascade settings for “30 kHz,” “80 kHz,” “>500 kHz” are substituted with “FS/2” in ATS.
- Cascade and S2 hardware option filters are not supported in ATS-2.
- In the Cascade Analog Analyzer, Phase is an independent reading; in ATS-2, it is one of the Analyzer measurement modes. Since a test can only have one measurement mode, tests that use both analog Phase readings and readings from another measurement mode (such as THD+N Ratio or Amplitude) may not be mapped correctly. All sweeps and bargraphs in the original test will be examined; if any refer to the analog Phase reading, the Phase measurement mode will be selected and references to other measurement modes will be ignored. This does not apply to the Digital Analyzer case, since the implementation used by the Digital Analyzer is the same as that in ATS-2.
- The fields (and hardware) controlling the Monitor Speaker are quite different between products. An attempt is made to map these, but it

is more than likely incorrect and will need to be modified by the user to obtain the desired behavior, if necessary.

- The Harmonic analysis program in System One is very different from the Harmonic Analyzer used in System Two, Cascade and ATS-2. The translator attempts to map the S1 Harmonic program to the ATS-2 Audio Analyzer, as it is more similar to the System One program, but this will likely need to be reworked by the user.

Digital I/O

- Cascade Serial and Parallel I/O modes are not supported, and are mapped to “XLR” in ATS-2.
- Cascade Dual BNC I/O modes are not supported, and are mapped to “Dual XLR” modes in ATS-2.
- Random and Squarewave jitter generation modes are not supported. These are mapped to sinusoidal jitter.
- Equalization on digital output streams is not supported. These settings are mapped to equivalent non-equalized settings.
- Embedded audio in the digital output cannot be scaled by the Measured Output Rate. This setting is mapped to Output Rate.
- The XLR Common Mode digital input configuration is not available in ATS-2. This setting is mapped to XLR.

Compute Functions

- **Compute Sigma** is not available. If a test is imported with **Compute Sigma** in the Compute Status list, this list entry will be deleted.

Index

A

- aai file 212
- aam file 185
- aas file 185
- Absolute values, FFT display processing 175
- AC coupling 127
 - also see coupling
- Acquisition waveform file
 - Digital Interface Analyzer 212
 - Multitone & Spectrum Analyzer
 - combining mono to stereo 185, 235
 - compatibility 185, 235
 - opening 185, 235
 - saving 184, 234
- ADC
 - see Analog-to-digital converter 41
- Add-In 24
- AES/EBU 384
- AES3 384
- afh 401
- afl 401
- afw 401
- AGen track tuned filter
 - see bandpass/bandreject filter 150
- agm file 239
- ags file 239
- A-Law 55, 64
 - also see μ -Law
- Algorithm
 - settling 280
- Amplitude control
 - Analog Generator 80
 - Digital Generator 102
- Amplitude measurements
 - Audio Analyzer 131
- Amplitude units 80, 102
- Analog amplitude units 372
- Analog Generator
 - overview 77
- Analog Input panel
 - converter and sample rate selection 48
 - DC coupling 47
 - input ranging 47
 - overview 45
 - peak monitors 46
 - source selection 45
- Analog Inputs
 - diagram & description 37
 - front panel connectors 32
- Analog Outputs
 - configuring 94
 - diagram & description 36
 - front panel connectors 32
- Analog-to-digital converter
 - for analog inputs 41
 - for Digital Interface Analyzer 188
- Analysis, overview
 - see signal analysis, overview. 41
- AP Basic
 - documentation 353
 - Extensions Manual 7
 - overview 351
 - User's Guide Manual 6
- APIB 31
- APIB interface
 - rear-panel connector 34
- Append
 - data saved in file to sweep 266
 - sweep setting 266
- APWIN to ATS translator 417
- Arbitrary waveform
 - shared memory buffers 92, 115
- Arbitrary waveforms 91, 114
- ASCII data file 315
- astx file 315

- ATS-2 Measurement Software
 - overview 9
 - panel readings 12
 - panel settings 11
 - panels, overview 10
 - Status bar 19
 - user interface. 9
 - atsa file 310
 - atsb file 351
 - atsl file 310
 - atsq file 310
 - atss file 310
 - Attached File Editor 313
 - Audible monitor 337
 - Audible monitor source selection 338
 - Audio Analyzer 123
 - Auto On 79, 101
 - Automating tests 351
 - Aux Control input 348
 - Aux Control output 348
 - Auxiliary bits, digital audio signal 385
 - Auxiliary Control In and Out
 - rear-panel connectors 34
 - Average, Compute algorithm 324
 - Averaging, Digital Interface Analyzer 207
 - Averaging, Spectrum Analyzer 167
 - power (spectrum) averaging 172
 - synchronous averaging 168
 - A-weighting filter
 - see weighting filter 146
- B**
- B, bad (invalid) data flag
 - see Data Editor, invalid data flag 309
 - Bandpass measurements
 - Audio Analyzer 136
 - Bandpass/Bandject filter 149
 - Bandwidth
 - limitations, Harmonic Dist. Analyzer 249
 - Bandwidth filter 144
 - Bandwidth, FFT 394
 - Bar graph
 - overview 303
 - to display readings 305
 - to make settings. 306
 - Basic language 351
 - Batch mode measurements 257
 - Batch mode vs. real-time measurements 43, 393
 - Bin width, FFT 395
 - Bi-phase mark encoding 385
 - Blackman-Harris FFT window
 - Digital Interface Analyzer 207
 - Spectrum Analyzer 163
 - Block diagram
 - system. 4
 - Bottom values, sweep data 262
 - BP/BR filter
 - see bandpass/bandreject filter 149
 - Buffer, graph 294
 - BW
 - see bandwidth filter 144
- C**
- C bit 386
 - CCIR-weighting filter
 - see weighting filter 146
 - CCITT-weighting filter
 - see weighting filter 146
 - Center, Compute algorithm 322
 - Changing data with Compute 317
 - Channel selection
 - Analog Generator 79
 - Digital Generator 101
 - Channel status bit 386
 - see status bits 70
 - Chart recorder sweep mode 277
 - Clock jitter measurement 206
 - CMT
 - see common mode testing 128
 - Color
 - trace 298
 - Color cycle 298
 - Colors
 - configuration 366
 - Comment, graph 293
 - Common mode testing
 - coupling issues. 128
 - Compute algorithms
 - Average. 324
 - Center 322
 - comparing with orig. data 327
 - Delta 323
 - Equalize. 326
 - Invert 320
 - Linearity 321
 - Maximum 325
 - Minimum 325
 - Normalize 319
 - overview 317
 - Smooth 320
 - Compute Status list 326
 - Configuration
 - colors 366
 - general 362
 - graph 366
 - Log file 364
 - overview 361
 - trace 366
 - Connection
 - bar graph. 305
 - Constant Value waveform 120
 - Consumer format, digital interface 384
 - Copy
 - a window, panel or screen to clipboard 334
 - graph to clipboard 334

- Copy to Sweep Panel command 289
 - Counter tuned filter
 - see bandpass/bandreject filter 150
 - Coupling 127
 - Spectrum Analyzer 166
 - with common mode testing 128
 - Crosstalk measurements
 - Audio Analyzer 133
 - Crosstalk ratio
 - see crosstalk measurements
 - Ctrl F6
 - see Sweep Reprocess Data command . . . 287
 - Cursors, graph 289
- D**
- Data 1 261
 - Data 3, 4, 5, 6 264
 - Data Editor
 - data file types 310
 - data that will not graph 307
 - editing the current data 309
 - graph legend linkage 296
 - invalid data flag 309
 - lower limit flag 309, 314
 - overview 307
 - regulation flag 309
 - saving test data 310
 - timeout flag 309
 - upper limit flag 309, 314
 - Data file 310, 314
 - Data, test 308
 - dB, discussion 372
 - dBFS 376
 - dB generator reference 122
 - DC coupling 127
 - DCX-127
 - units 381
 - decibel, discussion 372
 - Deemphasis
 - digital audio 65
 - also see preemphasis
 - Delay time
 - pre-sweep 269
 - settling 280
 - Delta, Compute algorithm 323
 - Dependent variable 261
 - Detector
 - function meter 141
 - DGen track tuned filter
 - see bandpass/bandreject filter 150
 - Digital amplitude units 376
 - Digital data units 378
 - Digital full scale 376
 - Digital Generator
 - frequency units 101
 - overview 99
 - panel 100
 - Digital I/O panel
 - overview 51
 - Digital Input
 - connection 39
 - front panel connectors 32
 - selecting dual connector mode 62
 - selecting the format 61
 - selecting the input impedance 62
 - Digital Input/Output panel
 - see Digital I/O panel 51
 - Digital Interface Analyzer
 - overview 187
 - Digital interface serial formats
 - electrical vs. data characteristics 39
 - Digital interface signal
 - input coding indicator 68
 - input confidence indicator 68
 - input configuration 60
 - input data bit indicators 67
 - input error indicators 68
 - input frequency scaling 65
 - input jitter measurement (DIO) 69
 - input lock indicator 68
 - input parity bit indicator 68
 - input peak monitors 66
 - input resolution 64
 - input sample rate
 - see ISR
 - input validity bit indicator 69
 - input voltage 63
 - output configuration 52
 - output frequency scaling 57
 - output polarity 57
 - output resolution 55
 - output voltage 54
 - output: jitter generation 58
 - output: send errors 57
 - Rate Ref 66
 - Digital interface signal amplitude histogram
 - Digital Interface Analyzer 197
 - Digital interface signal bit rate histogram
 - Digital Interface Analyzer 199
 - Digital interface signal pulse width histogram
 - Digital Interface Analyzer 198
 - Digital interface signal spectrum
 - Digital Interface Analyzer 195
 - Digital interface signal waveform
 - Digital Interface Analyzer 191
 - Digital Output
 - connection 38
 - front panel connectors 32
 - DIN IMD measurements
 - see IMD measurements 137
 - DIN IMD waveforms 112
 - DIO panel
 - see Digital I/O panel
 - Display samples, FFT display processing. . . 174
 - Dither 120
 - Documentation
 - about this manual 2
 - Getting Started Manual xix, 5
 - see Help, online

- Domain
 - analog vs. digital 5
- D-to-A converter testing
 - monotonicity waveform 118
- Dual Connector Mode 53
- Dual sine waveforms 105
- Dual XLR
 - see also Dual Connector Mode 53
- Dual XLR 2xOSR
 - see also Dual Connector Mode 53
- E**
- Edit menu 14
- Editing data
 - see data editor 307
- EIAJ 384
- EQ file 310
- EQ sine waveforms 107
- Equalization
 - generator 87, 107
- Equalize, Compute algorithm 326
- Equiripple FFT window
 - Digital Interface Analyzer 208
 - Spectrum Analyzer 164
- Errors, logging 314
- Export
 - acquisition to WAV file 409
 - graph 334
- External sweep
 - end-on 274
 - single-point 277
 - spacing 273
 - start and stop 273
 - start-on rules 275
 - stereo 277
- External sweeps
 - Source 1 271
- External vs. internal sweeps 271
- Eye pattern
 - Digital Data Analyzer 192
- F**
- Fast RMS detector
 - see detector, function meter 142
- Fasttest
 - Multitone Audio Analyzer 213
- FFT acquisition 157, 394
- FFT acquisition length. 160
- FFT acquisition record 159, 394
- FFT bandwidth. 394
- FFT bin width 395
- FFT commands. 158
- FFT display processing 173
 - Digital Interface Analyzer 202
 - Spectrum Analyzer 157
- FFT graphing 400
- FFT record looping 396
- FFT Spectrum Analyzer
 - Spectrum Analyzer 155
- FFT start time 177
- FFT transform record 161
- FFT transforming 157
- FFT trigger delay time 180
- FFT trigger slope. 180
- FFT triggering 177
- FFT triggering with quasi AC coupling 182
- FFT triggering with synchronous averaging 181
- FFT windows 397
 - Digital Interface Analyzer 207
 - Spectrum Analyzer 161
- FFT, synchronous 399
- FFTs overview 393
- File
 - data 26
 - macro 25
 - test 25
- File menu 13
- Filters, user. 401
- Fixed range
 - see ranging, meter
- Flat-top FFT window
 - Digital Interface Analyzer 208
 - Spectrum Analyzer 163
- Floor
 - settling 282
- Fltr field, function meter 145
- Frame, digital audio signal 385
- Frequency counters
 - see frequency meters
- Frequency meters
 - Analog Analyzer 128
- Frequency steering control, Harmonic Dist. Analyzer 251
- Frequency units 79, 101, 379
- Frequency, generator reference 122
- Frequency/Time domain toggle button 182
- Frequency-domain view
 - see Spectrum Analyzer
- FS: digital full scale 376
- Function keys 27
- Function meters. 130
- Function monitor outputs 340
- Fundamental amplitude meters, Harmonic Dist. Analyzer. 248
- Fundamental frequency meters, Harmonic Dist. Analyzer. 248
- F-weighting filter
 - see weighting filter
- G**
- Gaussian FFT window 164
- Generating test signals. 77, 99
- GenMon 46

- Go, sweep command 266
- GPIB 7, 31
- Graph
- "printing" to a file 333
 - buffer 294
 - comment 293
 - configuration 366
 - copy to clipboard 334
 - cursors 289
 - export 334
 - legend 295
 - options menu 287
 - overview 285
 - printing 329
 - sweep and table relationship 255, 285
 - sweep display mode 265
 - titles and labels 293
 - zoom 286
- Graph, bar
- see Bar graph
- Graphic aliasing 176
- Graphing FFTs 400
- Graphing Harmonic Dist. Analyzer results 254
- Gray (as reference trace color) 294
- ## H
- Hamming FFT window 164
- Hann FFT window
- Digital Interface Analyzer 207
 - Spectrum Analyzer 163
- Hardware status 368
- Harmonic Distortion Analyzer
- bandwidth limitations 249
 - overview 245
- Harmonic selection in bandpass measurements 150
- Harmonic sum meters, Harmonic Dist. Analyzer 248
- Harmonic weighting filter
- see weighting filter
- Headphone monitoring 337
- Headphone/Speaker panel 338
- Headphone/Speaker source selection 338
- Help menu 18
- Help, online 6
- HI-2 harmonic weighting filter
- see weighting filter
- High bound, Regulation parameter 357
- Highpass filter
- see bandpass filter
- Histogram
- Digital Interface Analyzer 197
- Hot keys 27
- ## I
- IEC60958 384
- IIR filter 401
- IMD measurements
- Audio Analyzer 137
 - IMD waveforms 89, 112
- Import
- acquisition from WAV file 411
- Independent variable 256, 258
- Infinite impulse response filter 401
- Input sample rate
- see ISR
- Interchannel Phase measurements
- see phase measurements
- Intermodulation Distortion
- see IMD
- Internal vs. external sweeps 271
- Interpolate, FFT display processing 174
- Intervu
- see Digital Interface Analyzer
- InterVuMenu.atsb 201
- Invalid multitone readings 233
- Invert 102
- Invert, Compute algorithm 320
- ISR 63
- Iterations, Regulation setting 358
- ## J
- Jitter detection, Digital Interface Analyzer
- clock (squarewave) signal 206
 - digital interface signal 204
- Jitter histogram
- Digital Interface Analyzer 195, 200
- Jitter waveform
- Digital Interface Analyzer 193
- J-Test waveform 119
- ## K
- Keyboard shortcuts 27
- ## L
- L, lower limit flag
- see Data Editor, lower limit flag
- Labels, graph 293
- Learn mode 351
- enter 369
 - exit 369
- Learn Mode toolbar 23
- Legend / Data Editor linkage 296
- Legend, graph 295
- Level meters
- Audio Analyzer 126
 - Level monitors, Spectrum Analyzer 157
- Limit file 310, 311

- Limits
 - actions upon failure 314
 - Attached File Editor 313
 - attaching a limit file 312
 - making a limit file 311
 - overview 310
 - sweep data limits 263
 - Lin scale
 - sweep Data 262
 - sweep Source 260
 - Lin scale, Source 1 260
 - Linear, Regulation algorithm 357
 - Linearity, Compute algorithm 321
 - Log errors 314
 - Log file
 - clear 368
 - configuration 364
 - view 368
 - Log scale
 - sweep Data 262
 - sweep Source 261
 - Log scale, Source 1 260
 - Looping, FFT record 396
 - Low bound, Regulation parameter 357
 - Lowpass filter
 - see bandpass filter
- M**
- μ -Law 55, 64
 - also see A-law
 - Macro 351
 - Macro Editor 353
 - Macro toolbar 23
 - Macro translator 422
 - Makewave
 - see Multitone Creation Utility
 - Masking curve analysis 224
 - MATLAB 412
 - Maximum, Compute algorithm 325
 - Maximum, Regulation algorithm 357
 - Minimum, Compute algorithm 325
 - Minimum, Regulation algorithm 358
 - Modifying data with Compute 317
 - Monitor outputs 339
 - Monitor Outputs
 - rear-panel connectors 34
 - Monitoring
 - Digital Interface Analyzer 212
 - Monotonicity waveform 117
 - Move to bin center FFT "window" 165
 - Multitone
 - analysis 218
 - informing analyzer about waveform . . 216
 - invalid readings 233
 - minimum multitone duration 232
 - waveform requirements 215
 - Multitone Audio Analyzer
 - capabilities 214
 - introduction 213
 - processing 228
 - rss summing resolution 227
 - setting record length 227
 - setting the generator 216
 - trigger delay 230
 - triggering modes 229
 - triggering resolution 226
 - Multitone Creation Utility 236, 369
- N**
- + Normal, -Normal Regulation algorithms 357
 - Nested sweeps 269
 - Noise in the presence of signal 222
 - Noise waveforms 90, 113
 - None, move to bin center FFT "window" . 165
 - Normalize, Compute algorithm 319
 - Notch filter
 - see bandpass/bandreject filter
- O**
- Object linking and embedding 351
 - Offset, Sine+ waveform 111
 - OLE 351
 - Operation, Regulation setting 357
 - Optimize, graph 288
 - Oscilloscope view
 - see Spectrum Analyzer
 - OSR 54
 - Output Sample Rate
 - see OSR
 - Outputs ON-OFF
 - Analog Generator 79
 - Digital Generator 101
 - Outputs, monitor 339
 - Overview, ATS-2
 - capabilities 3
 - system 1
- P**
- P bit 386
 - Page setup 330
 - Panels menu 16
 - Panels toolbar 22
 - Parity bit 386
 - Pass-thru feature 93, 116
 - Pause, sweep command 266
 - PCM 383
 - Peak equivalent sinewave 80, 103
 - Peak picking 176
 - Peak values, FFT display processing . . . 175
 - Peaking filter
 - see bandpass/bandreject filter

- Phase measurements
 - Audio Analyzer 138
 - Phase units 380
 - Polarity
 - digital interface signal 57
 - test waveform 93, 115
 - Polarity inversion 102
 - Power entry module
 - mains fuse and voltage selection 33
 - mains power cord 33
 - mains power switch 33
 - mains voltage indicator 33
 - Power recycle time 34
 - Preamble, digital audio signal 385
 - Preemphasis
 - also see deemphasis
 - digital audio 56
 - Pre-sweep delay 269
 - Printing
 - graphs 329
 - page setup 330
 - Procedure
 - see macro
 - Procedure Editor
 - see Macro Editor
 - Procedure translator 422
 - Professional format, digital interface . . . 384
 - Pulse code modulation
 - see PCM
- Q**
- Quasi-peak detector
 - see detector, function meter
 - Quick Launch toolbar 24
- R**
- R, regulation flag
 - see Data Editor, regulation flag
 - Random waveform 120
 - Ranging, meter
 - Audio Analyzer 129
 - function meter 140
 - Rate Ref 66
 - Ratio measurements, level
 - see 2-channel ratio measurements
 - Ratio units 378
 - Reading rate
 - function meter detector 142
 - Real-time sweeps 257
 - Real-time vs. batch mode measurements . 43, 393
 - Rectangular probability distribution function
 - see dither
 - Reference input 341
 - Reference Input source 343
 - Reference Rate, Digital
 - see Rate Ref
 - Reference trace 294
 - References
 - Analog Generator 95
 - Audio Analyzer, analog input 151
 - Audio Analyzer, digital input 152
 - Digital Generator 122
 - Digital Interface Analyzer 211
 - Harmonic Distortion Analyzer 251
 - Multitone Audio Analyzer 231
 - Regulation
 - algorithms 357
 - examples of regulated sweeps 359
 - overview 355
 - panel selections 356
 - Relative units 378
 - Repeat, sweep setting 266
 - Reprocess Data
 - see Sweep Reprocess Data command
 - Resolution
 - input 64
 - Output 55
 - Resolution, sweep 260
 - Rife-Vincent FFT window 164
 - RMS detector
 - see detector, function meter
 - RPDF
 - see dither
- S**
- S/PDIF 384
 - Sample rate
 - DAC 91
 - for arbitrary waveform files 92, 115
 - for pass-thru feature 117
 - Saving test data 310
 - Scale frequency
 - input 65
 - Scale Frequency
 - output 57
 - Script
 - see macro
 - SDI
 - see serial digital interface signal
 - Serial digital interface signal 384
 - Setting limits
 - see limits
 - Settling
 - algorithm 280
 - floor 282
 - see sweep settling
 - tolerance 282
 - Shaped dither
 - see dither
 - Shortcuts, keyboard 27

- Signal analysis, overview 41
 - Analyzer instruments 43
 - audio signal analysis 41
 - digital signal analysis 42
 - serial digital interface analysis 42
 - Sweeps and Graphs 44
- Signal inputs and outputs, main
 - overview 35
- Sine Dual waveforms 105
- Sine Stereo waveforms 105
- Sine Var Phase waveforms 104
- Sine + Offset waveform 111
- Sinewave
 - Analog Generator 81
 - Digital Generator 103
- Single-point sweeps 268
 - external 277
- Smooth, Compute algorithm 320
- SMPTE IMD measurements
 - see IMD measurements
- SMPTE IMD waveforms 112
- Software Add-In 24
- Source 1 258
 - in an external sweep 271
 - scales, log or lin 260
 - start and stop 260
- Source 2 258, 269
- Source monitor outputs 340
- Source, Reference Input 343
- Source, Regulation parameter 356
- SPDIF
 - see S/PDIF
- Speaker monitoring 337
- Speaker/Headphone panel
 - see Headphone/Speaker panel
- Spectrum Analyzer commands 158
- Spectrum FFT display processing 176
- Spectrum/Waveform toggle button 182
- Spectrum Analyzer 155
- Squarewave
 - Analog Generator 89
 - Digital Generator 112
- Standard toolbar 20
- Status bits
 - consumer format 72
 - CRC 74
 - hex control and display 75
 - in dual-connector mode 75
 - local address and time of day 73
 - panel 70
 - professional format 73
 - transmit 71
- Stepsize, Regulation setting 358
- Stereo sine waveforms 105
- Stereo, sweep setting 267
- Stop, sweep command 266
- Subframe, digital audio signal 385
- Sweep
 - overview 255
 - Sweep display mode 265
 - Sweep file 310
 - Sweep panel 258
 - Sweep planning 257
 - Sweep Reprocess Data command 287
 - Sweep resolution 260
 - Sweep settling
 - concepts 280
 - delay time 280
 - panel 279
 - Sweep Settling
 - overview 278
 - Sweep table
 - for a multitone file 241
 - Sweep track tuned filter
 - see bandpass/bandreject filter
 - Sweep, graph and table relationship 255
 - Sweeps, time 277
 - Sync input 341
 - Sync/Ref In 341
 - rear-panel connector 34
 - Sync/Ref Input panel 342
 - Sync/Ref squarewave frequency 343
 - Synchronous FFT 399
- T**
 - 2-channel ratio measurements
 - Audio Analyzer 132
 - T, timeout flag
 - see Data Editor, timeout flag
 - Table sweeps 270, 310
 - Table, sweep and graph relationship 255
 - Table, sweep display mode 265
 - Target Range, bargraph 305
 - Target, Regulation parameter 356
 - Terminate sweep on failure 314
 - Test
 - data 308
 - Test translator 418
 - THD + N 134
 - amplitude measurements 136
 - ratio measurements 135
 - Time sweeps 277
 - Time units 380
 - Time-domain view
 - see Spectrum Analyzer
 - Timeout per step, Regulation setting 358
 - Titles, graph 293
 - Tolerance
 - settling 282
 - Tolerance, Regulation parameter 356
 - Tone burst 84, 106
 - Top values, sweep data 262
 - Total harmonic distortion plus noise
 - see THD + N
 - TPDF
 - see dither

- Trace
 - color cycle 298
 - colors 298
 - configuration 366
 - reference 294
 - selection for printing 331
 - Triangular probability distribution function
 - see dither
 - Trigger
 - Digital Interface Analyzer 209
 - Multitone Audio Analyzer 229
 - Trigger In and Out
 - rear-panel connectors 34
 - Trigger output 345
 - Tuning, bandpass or bandreject filter
 - see bandpass/bandreject filter
 - Tuning, notch or peaking filter
 - see bandpass/bandreject filter
- ## U
- U bit 386
 - U, upper limit flag
 - see Data Editor, upper limit flag
 - Units of measurement 371
 - analog amplitude 372
 - DCX-127 381
 - digital amplitude 376
 - digital data 378
 - frequency 379
 - function meter 140
 - phase 380
 - ratio 378
 - relative 378
 - time 380
 - User bit 386
 - User downloadable filters 147
 - designing 401
 - overview 401
 - User filters 401
 - see user downloadable filters
 - User weighting filters
 - see user downloadable filters
- ## V
- V bit 386
 - V/FS generator reference 122
 - Validity bit 386
 - Value, Regulation parameter 356
 - Variable phase sine waveforms 104
 - View menu 15
 - Visual Basic 351
 - Volume bar 337
- ## W
- .wav file
 - creating a multitone .wav file . . . 237, 242
 - Walking Ones and Zeros waveforms
 - Digital Generator 119
 - WAV file
 - export 409
 - import 411
 - Waveform file support 412
 - Waveforms
 - Analog Generator 81
 - Digital Generator 103
 - Weighting filter 145
 - Windows, FFT 397
 - Word Width
 - see Resolution
 - Word, digital audio signal 385
 - Workspace 10
- ## X
- X vs. Y data plot 263
 - X-axis graph divisions 261
- ## Y
- Y-axis graph divisions 263
- ## Z
- Zoom 286

