

Ceramic DC Disc, RFI and Safety Capacitors

IN ACCORDANCE WITH IEC RECOMMENDATIONS CERAMIC CAPACITORS ARE SUBDIVIDED INTO TWO CLASSES:

- CERAMIC CLASS 1 or low-K capacitors are mainly manufactured of titanium dioxide or magnesium silicate
- CERAMIC CLASS 2 or high-K capacitors contain mostly alkaline titanates

MAIN FEATURES		
	CLASS 1	CLASS 2
APPLICATION	For temperature compensation of frequency discriminating circuits and filters, coupling and decoupling in high-frequency circuits where low losses and narrow capacitance tolerances are demanded. As RFI and safety capacitors.	As coupling and decoupling capacitors for such application where higher losses and a reduced capacitance stability are required. As RFI and safety capacitors
PROPERTIES Temperature Dependence Capacitance	High stability of capacitance. Low dissipation factor up to higher frequencies. Defined temperature coefficient of capacitance, positive or negative, linear and reversible. High insulation resistance. No voltage dependence. High long-term stability of electrical values.	High capacitance values with small dimensions. Non-linear dependence of capacitance on temperature.
DC VOLTAGE CAPACITANCE DEPENDENCE	None	Increasing with ϵ
DISSIPATION FACTOR TAN δ	max. 0.0015 (Typical)	max. 0.035 (Typical)
INSULATION RESISTANCE	min. 10 000 M Ω to 200 000 M Ω	min. 10 000 M Ω to 200 000 M Ω
CAPACITANCE TOLERANCES	< 10 pF: ± 0.25 pF, ± 0.5 pF, ± 1 pF ≥ 10 pF: ± 2 %, ± 5 %, ± 10 %, ± 20 %	± 10 %, ± 20 %, (+ 50 - 20) %, (+ 80 - 20) %
RATED VOLTAGE	100 V _{DC} up to 15 kV _{DC}	100 V _{DC} up to 15 kV _{DC}

STANDARDS AND SPECIFICATIONS	
GENERAL STANDARDS	
IEC 60062	Marking codes for resistors and capacitors
IEC 60068	Basic environmental testing procedures
Special Standards for Ceramic Capacitors	
EN 130600 and IEC 60384-8	Fixed capacitors of ceramic dielectric, class 1
EN 130700 and IEC 60384-9	Fixed capacitors of ceramic dielectric, class 2
Standards for Special Application Purposes	
UL 1414 UL 1283 CSA C22.2 EN 132400 IEC 60384-14.2 IEC 60065	RFI - and safety capacitors



MEASURING AND TESTING CONDITIONS		
CAPACITANCE AND DISSIPATION FACTOR	Class 1 C ≥ 1000 pF: 1 kHz, 1 to 5 V _{RMS} C < 1000 pF: 1 MHz, 1 to 5 V _{RMS}	Class 2 C ≥ 100 pF: 1 kHz, 1.0 ± 0.2 V _{RMS} C < 100 pF: 1 MHz, 1.0 ± 0.2 V _{RMS}
INSULATION RESISTANCE	Rated voltage < 100 V: ≥ 100 V to < 500 V: ≥ 500 V:	measuring voltage = (10 ± 1) V measuring voltage = (100 ± 15) V measuring voltage = (500 ± 50) V 60 ± 5 s
DIELECTRIC STRENGTH	Rated voltage ≤ 500 V: > 500 V: Test time:	Test voltage = 2.5 • UR Test voltage = 1.5 • UR 2 s

Note

1. Climatic test conditions: Temperature 20 °C to 25 °C
2. Relative humidity 50 % to 70 %

NOMINAL VALUE SERIES ACCORDING TO IEC 60063		
E6 (± 20 % TOLERANCE)	E12 (± 10 % TOLERANCE)	E24 (± 5 % TOLERANCE)
100	100	100
	120	110
		120
150	150	130
		150
	180	160
		180
220	220	200
		220
		240
	270	270
		300
330	330	330
		360
	390	390
		430
		470
470	470	470
		510
	560	560
		620
680	680	680
		750
	820	820
		910

Note

1. E6 values preferred

General Information

Vishay Cera-Mite

Ceramic DC Disc, RFI and Safety Capacitors



CAPACITANCE CODING SYSTEM acc. to IEC 60062			
CAPACITANCE VALUE	CODE	CAPACITANCE VALUE	
	p33	0.33 pF	
	3p3	3.3 pF	
	33p	33 pF	
	330p	330 pF	
	n33	330 pF (0.33 nF)	
	3n3	3300 pF (3.3 nF)	
	33n	33 000 pF (33 nF)	
	330n	330 000 pF (330 nF)	
	μ33	0.33 μF	
3μ3	3.3 μF		
CAPACITANCE TOLERANCE	CODE	< 10 pF: in pF	≥ 10 pF: in %
	C	± 0.25	-
	D	± 0.5	-
	J		± 5
	K		± 10
	M		± 20
	Y		+ 50/- 20
	Z		+ 80/- 20
P		+ 100/- 0	

CAPACITANCE CODING SYSTEM acc. to CERA-MITE STANDARD		
CODE	CAPACITANCE VALUE	DIVIDER
Q 68	e.g. 0.000068 = 68 pF	'Quad' = Q
T 68	0.00068 = 680 pF	'Triple' = T
D 68	0.0068 = 6800 pF	'Double' = D
S 68	0.068 = 68 000 pF	'Single' = S

the two digits are the significant figures of the figures of the capacitance
 'Divider' - Number of zeros following the Decimal point of the Number of zeros following
 Basis is the Capacitance given in μF

CERAMIC DIELECTRIC CODING SYSTEM				
CLASS 1			CLASS 2	
INDUSTRY CODE	EIA CODE	CODE LETTER	EIA CODE	CODE LETTER
P100	C0K	----	X5F	B
NP0	C0G	A	X7R	C
N750	U2J	U	X7S	C
N1000	M3K	V	Y5U	E
N1500	P3K	W	Y5V	F
N2000	R3L	----	Z5U	E
N2200	R3L	X		
N2500	R3M	----		
N2800	----	----		
N3300	S3N	Y		
N4700	T3M	Z		



TEMPERATURE CHARACTERISTIC OF CAPACITANCE FOR CLASS 1 AND CLASS 2

CLASS 1 CERAMICS ACCORDING TO EIA-198-1, -2, -3

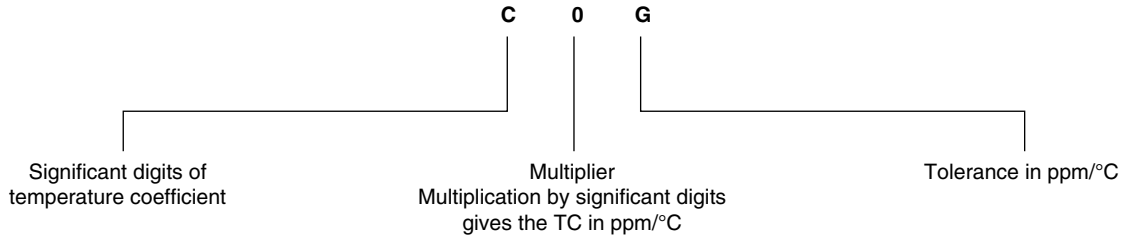

TOLERANCE	CODE LETTER
0.0	C
1.0	M
1.5	P
2.2	R
3.3	S
4.7	T
7.5	U

DIGIT	MULTIPLIER
0	- 1
1	- 10
2	- 100
3	- 1000
5	+ 1
6	+ 10
7	+ 100
8	+ 1000

TOLERANCE	CODE LETTER
± 30	G
± 60	H
± 120	J
± 250	K
± 500	L
± 1000	M
± 2500	N

Note: The rated values of the TC and the accompanying limit deviations are defined using the capacitance change between + 20 °C to + 85 °C

CLASS 2 CERAMICS ACCORDING TO EIA-198-1, -2, -3

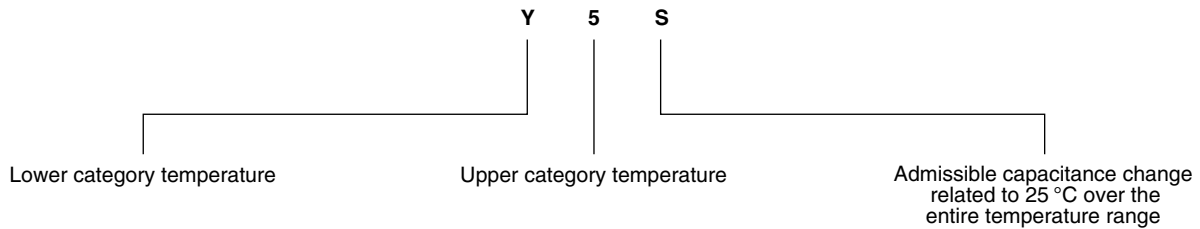

TEMPERATURE	CODE LETTER
- 55 °C	X
- 30 °C	Y
+ 10 °C	Z

TEMPERATURE	CODE FIGURE
+ 45 °C	2
+ 65 °C	4
+ 85 °C	5
+ 105 °C	6
+ 125 °C	7

CHANGE	CODE LETTER
± 1 %	A
± 1.5 %	B
± 2.2 %	C
± 3.3 %	D
± 4.7 %	E
± 7.5 %	F
± 10 %	P
± 15 %	R
± 22 %	S
+ 22 %/- 33 %	T
+ 22 %/- 56 %	U
+ 22 %/- 82 %	V



CLASS 1 CERAMIC TYPE TEMPERATURE COEFFICIENT OF THE CAPACITANCE

$$\frac{\Delta C}{C} [\%] = 100 \cdot \alpha \cdot \Delta \theta$$

ΔC = Capacitance change

α = Temperature coefficient in $10^{-6}/^{\circ}\text{C}$

$\Delta \theta$ = Temperature change in $^{\circ}\text{C}$

Temperature Coefficient of the capacitance

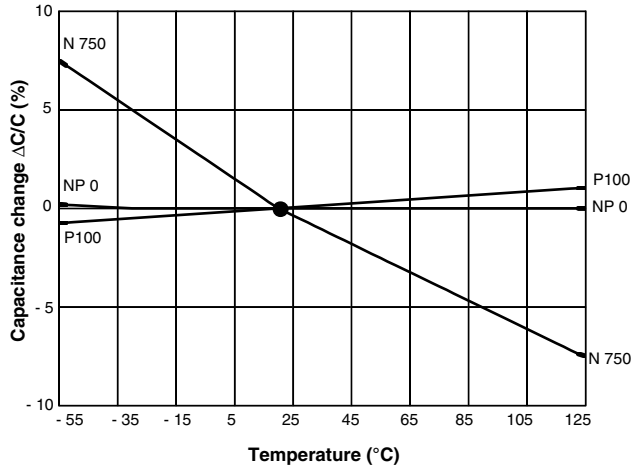

Temperature Coefficient of the capacitance

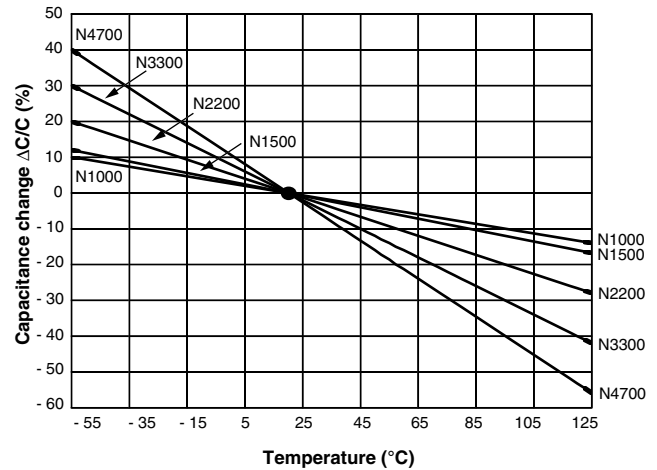

VOLTAGE DEPENDENCE OF CAPACITANCE

None

FREQUENCY DEPENDENCE OF CAPACITANCE

see page 8

DISSIPATION FACTOR

- For values greater than 50 pF: see data sheet.
- For lower values the dissipation factor is calculated according to the type of ceramic (rated temperature coefficient) under consideration of the capacitance acc. to EN 130600.
- The dissipation factor as well as the measuring method to be agreed between manufacturer and user for values lower than 5 pF.

CLASS 2 CERAMIC TYPE CAPACITANCE CHANGE VS. TEMPERATURE (TYPICAL)

CERAMIC DIELECTRIC: X5F AND X5R

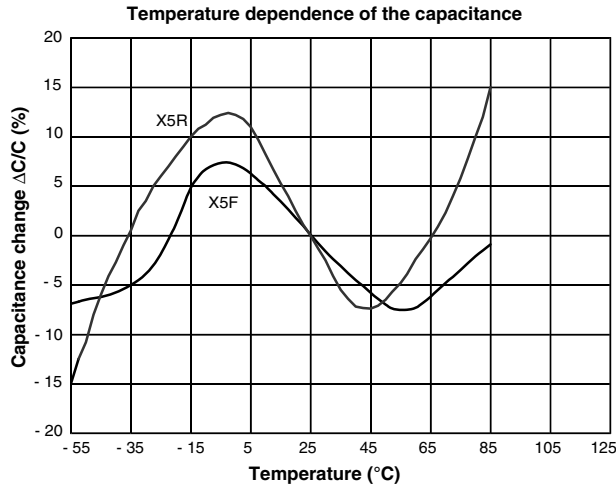

CERAMIC DIELECTRIC: X7R AND X7S

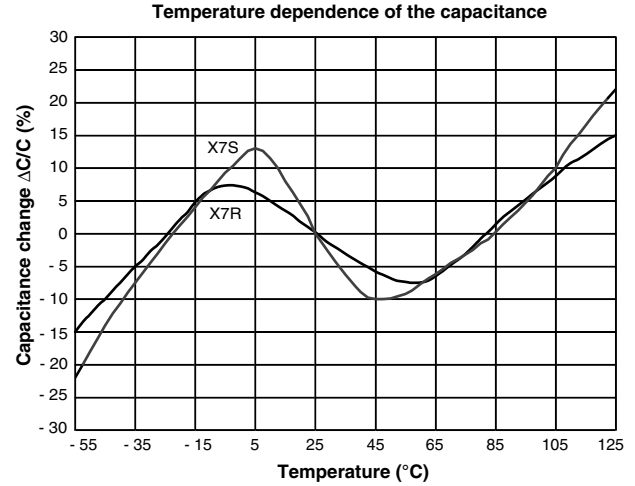

CERAMIC DIELECTRIC: Y5R AND Y5S

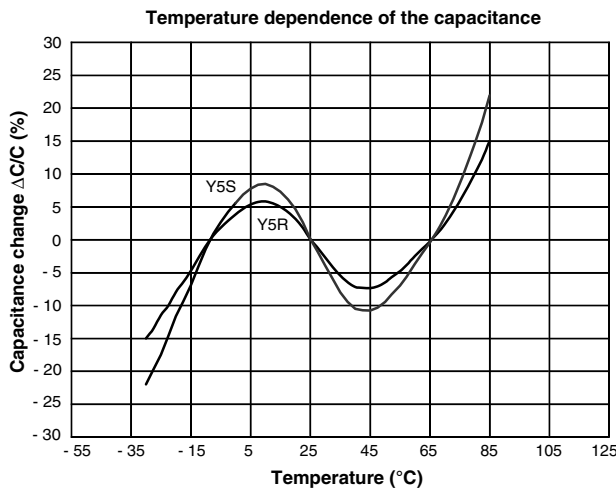

CERAMIC DIELECTRIC: Y5U AND Y5V

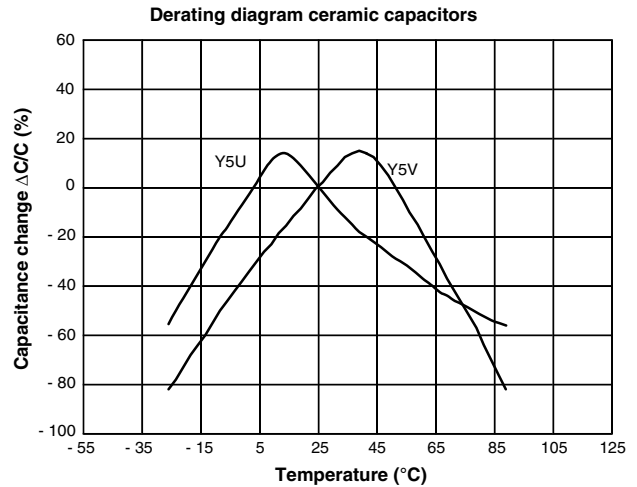

CERAMIC DIELECTRIC: Z5U

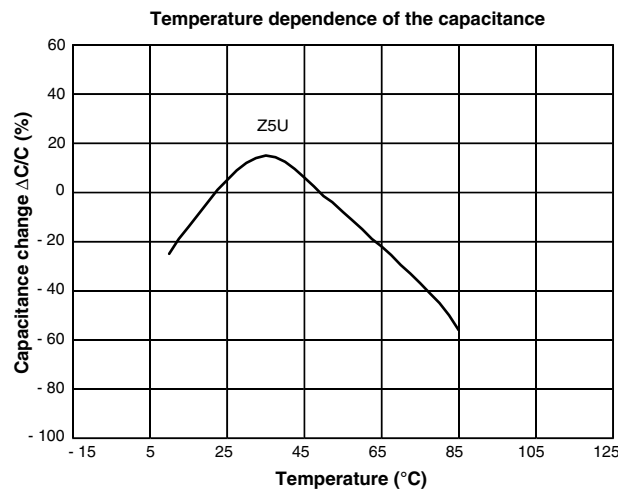



CLASS 2 CERAMIC TYPE CAPACITANCE CHANGE VS. FREQUENCY (TYPICAL)

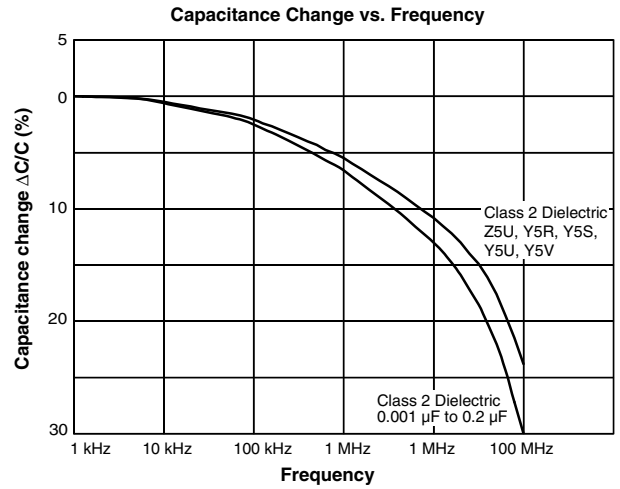
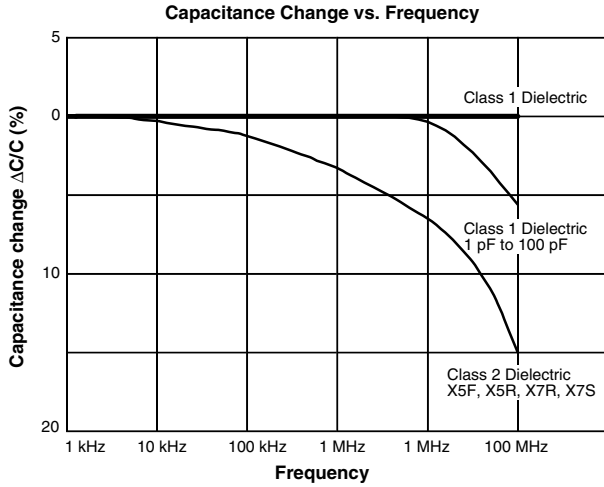

CAPACITANCE DECREASE VS. DC VOLTAGE BIAS (TYPICAL)

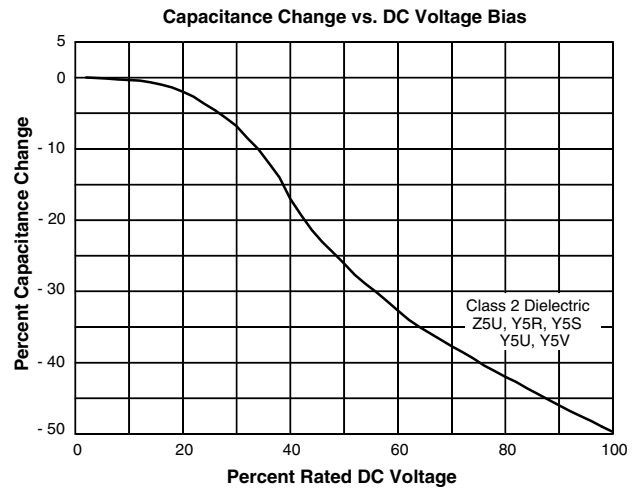
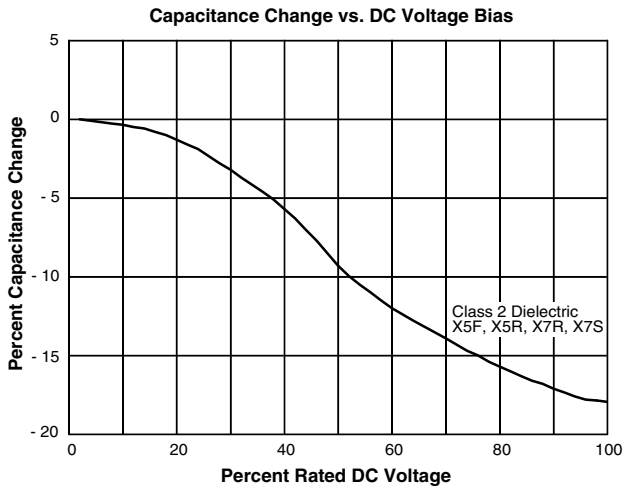



CAPACITANCE “AGING” OF CERAMIC CAPACITORS

Following the final heat treatment, all class 2 ceramic capacitors reduce their capacitance value. According to logarithmic law, this is due to their special crystalline construction. This change is called “aging”. If the capacitors are heat treated (for example when soldering), the capacitance increases again to a higher value deaging, and the aging process begins again.

Note:

The level of this deaging is dependent on the temperature and the duration of the heat; an almost complete deaging is achieved at the upper category temperature in one hour. These conditions also form the basis for reference measurements when testing. The capacitance change per time decade (aging constant) differs for the various types of ceramic, but typical values can be taken from the table below.

CERAMIC MATERIAL	X5F	X7R	X7S	Y5U	Y5V	Z5U
AGING KONSTANT k	- 1.5 %	- 2.0 %	- 3.0 %	- 2.0 %	- 2.5 %	- 2.8 %

$$k = \frac{100 \cdot (C_{t1} - C_{t2})}{C_{t1} \cdot \log_{10} (t_1/t_2)}$$

t₁, t₂ = measuring time point (h)

C_{t1}, C_{t2} = capacitance values for the times t₁, t₂

k = aging constant (%)

$$C_{t2} = C_{t1} \cdot (1 - k/100 \cdot \log_{10} [t_1/t_2])$$

REFERENCE MEASUREMENT

Due to aging, it is necessary to quote an age for reference measurements which can be related to the capacitance with fixed tolerance. According to EN 130700, this time period is 1000 hours.

If the shelf-life of the capacitor is known, the capacitance for t = 1000 h can be calculated with the aging constant.

In order to avoid the influence of aging, it is important to deage the capacitors before stress-testing. The following procedure is adopted (see also EN 130700):

- Deaging at upper category temperature, 1 hour
- Storage for 24 hours at normal climate temperature
- Initial measurement
- Stress
- Deaging at upper category temperature, 1 hour
- Storage for 24 hours at normal climate temperature
- Final measurement

General Information

Vishay Cera-Mite

Ceramic DC Disc, RFI and Safety Capacitors



COMPONENT CLIMATIC CATEGORY

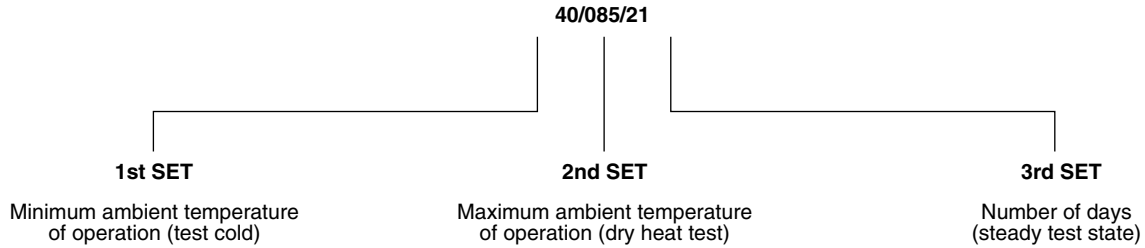

The large number of possible combinations of tests and severities may be reduced by the selection of a few standard groupings according to IEC 60068-1

Category examples acc. To IEC 60068-1
25/085/04
25/085/21
40/085/21
55/125/21
55/125/56

First set: Two digits denoting the minimum ambient temperature of operation (Cold test)

65	- 65 °C
55	- 55 °C
40	- 40 °C
25	- 25 °C
10	- 10 °C
00	0 °C
05	+ 5 °C

Second set: Three digits denoting the maximum ambient temperature (Dry heat test)

155	+ 155 °C
125	+ 125 °C
110	+ 110 °C
90	+ 90 °C
85	+ 85 °C
80	+ 80 °C
75	+ 75 °C
70	+ 70 °C
65	+ 65 °C
60	+ 60 °C
55	+ 55 °C

Third set: Two digits denoting the number of days of the damp heat steady state test (Ca)

56	56 Days
21	21 Days
10	10 Days
04	4 Days
00	The component is not required to be exposed to damp heat



STORAGE

The capacitors must not be stored in a corrosive atmosphere, where sulphide or chloride gas, acid, alkali or salt are present. Exposure of the components to moisture, should be avoided. The solderability of the leads is not affected by storage of up to 24 months (temperature + 10 °C to + 40 °C, relative humidity up to 60 % RH). Class 2 Ceramic Dielectric Capacitors are also subject to aging see previous page.

SOLDERING

SOLDERING SPECIFICATIONS		
Soldering test for capacitors with wire leads: (according to IEC 60068-2-20, solder bath method)		
	SOLDERABILITY	RESISTANCE TO SOLDERING HEAT
Soldering Temperature	(235 ± 5) °C	(260 ± 5) °C
Soldering Duration	(2 ± 0.5) s	(10 ± 1) s
Distance from Component Body	≥ 2 mm	≥ 5 mm

SOLDERING RECOMMENDATIONS

Soldering of the component should be achieved using a silver-bearing SN type solder. Ceramic capacitors are very sensitive to rapid changes in temperature (Thermal shock) therefore the solder heat resistance specification (see above table) should not sensitive to be exceeded. Subjecting the capacitor to excessive heating may result in thermal shocks that can crack the ceramic body. Similarly, excessive heating can cause the internal solder junction to melt.

CLEANING

The components should be cleaned immediately following the soldering operation with vapor degreasers.

SOLVENT RESISTANCE

The coating and marking of the capacitors are resistant to the following test method:

IEC 60068-2-45 (Method XA)

MOUNTING

We do not recommend modifying the lead terminals, e.g. bending or cropping. This action could break the coating or crack the ceramic insert. If however, the lead must be modified in any way, we recommend support of the lead with a clamping fixture next to the coating.

CAUTION

When Sinusoidal or ripple voltage applied to DC Ceramic Disc Capacitors, be sure to maintain the Peak-to-peak value or the peak value of the sum of both AC + DC within the Rated voltage Limits. When the voltage is started to apply the circuit or it is stopped applying, an irregular voltage may be generated because of resonance effects. Be sure to use the capacitor during this transient periode within it's rated voltage. When rectangular or Pulse Wave Voltage is applied to DC Ceramic Disc Capacitors, the Self-heating generated by the capacitor is higher than the sinusoidal application with the same frequency. The allowable voltage rating for the rectangular or pulse wave corresponds approximately with the allowable voltage of sinusoidal wave with the double fundamental frequency. The allowable voltage varies, depending on the voltage and the waveform. Diagrams of the limiting values are available for each Capacitor Series on request. The surface Temperature of the capacitors must not exceed the upper limit of it's Rated Operating Temperature. During operation in a High frequency circuit or a Pulse signal circuit, the capacitor itself generate heat due to dielectric losses. Applied voltage should be the load such as self-generated heat within 20 °C on the condition of environmental temperature 25 °C.

Note, that excessive heat may lead to deterioration of the capacitor's characteristics and reliability.



AOQ - AVERAGE OUTGOING QUALITY

In the final control all lots (100 % lot-by-lot) are tested on Sample Base.

All possible defects are classified into Minor and Major Defects.

They are defined as follows:

MAJOR DEFECTS

Defects from which it is to be assumed or known that they create dangerous situations for humans

Defects which may create considerable property damage

Defects from which it is to be expected that the pertaining equipment will fail.

Defects which create essential reduction of the usability for the planned application.

Lots with Major Defects always will be rejected.

It is essential: Target = Zero Defect

MINOR DEFECTS

Defects which do not create essential reduction of the usability for the planned application.

Defects which affect the usability, function or assembly of the pertaining equipment slightly

defects which increase substantially the internal (Vishay's) rejects.

Minor Defects shall not exceed the acceptance of the required sampling plan otherwise the lot will be rejected.

The AOQ is calculated on a quarterly basis for mechanical and electrical defects.

All lots with major defects and all lots with more minor defects as accepted in the relevant sampling plan will be rejected. That will be set to the ratio with the number of tested parts.

Actual the AOQ is

AOQ_{mechanical}: < 50 ppm

AOQ_{electrical}: < 150 ppm

These values are the End of Line Quality. The customer may expect lower AOQ levels.

RELIABILITY

Because of controlled manufacturing processes the quality of the ceramic capacitors is maintained on a high level.

The reliability data will be determined from the results of electrical endurance tests according to the relevant national or international specification.

The endurance tests are performed on the upper category temperature and with applied load according to the relevant specification. The applied voltage is up to 1.5 times of rated voltage. It depends on the specification.

As failure criterion is fixed:

Short circuit during test, 2 times the required limits according to the relevant specification.

Base for reliability calculation is the international specification IEC 61709

The failure rate of our ceramic capacitors is

CD Capacitors Class 1 Ceramic Dielectric: 100 fit

CD Capacitors Class 2 Ceramic Dielectric: 500 fit

AC Line Rated Capacitors: 5 fit

Detailed information is available on request.



PRODUCTION FLOWCHART

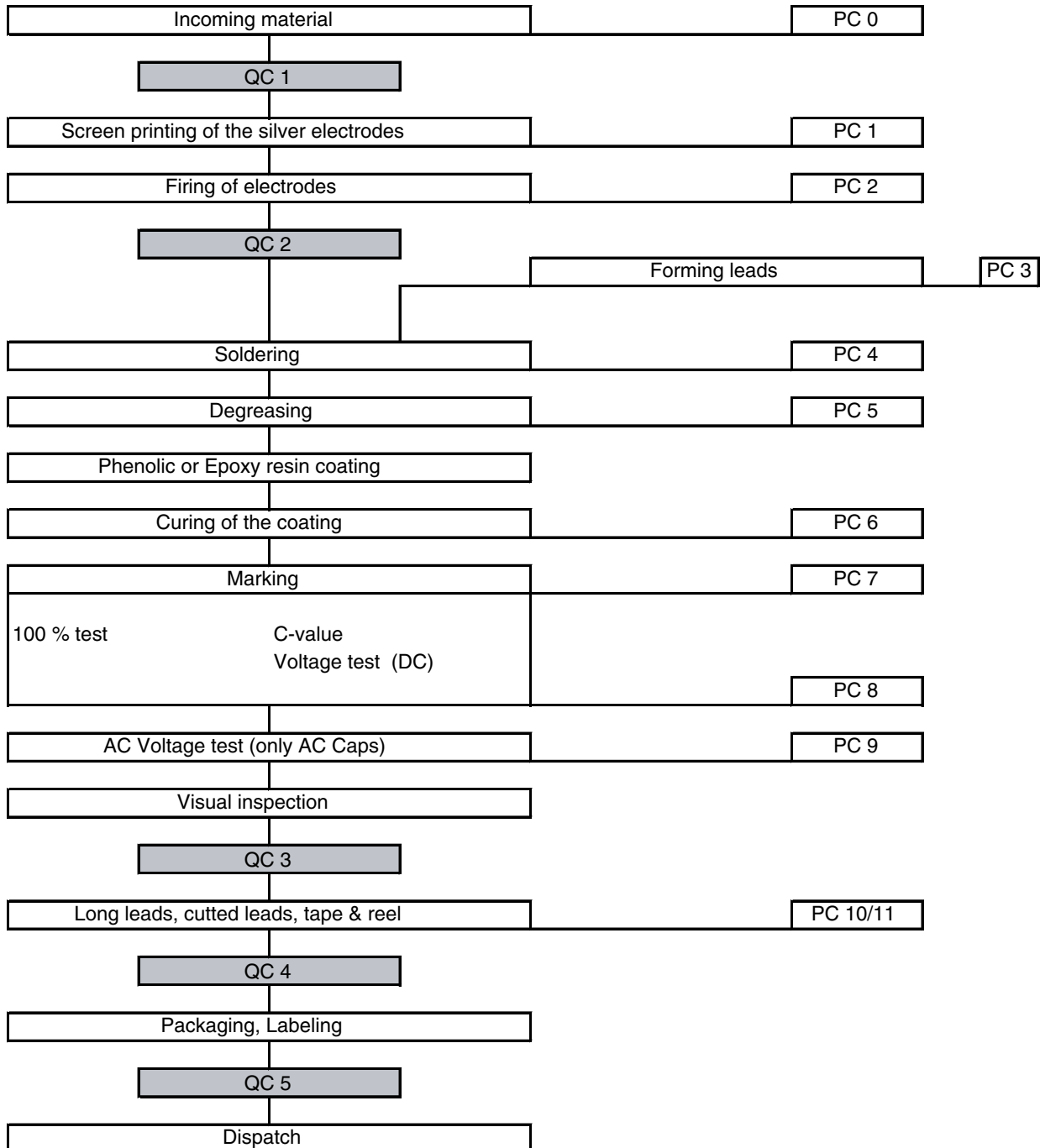

PC = Production control
QC = Quality control

WIRE LEAD OPTIONS

Radial leaded capacitors may be ordered with various wire lead options by adding appropriate suffix code to the catalog part number.

Example: 564R30GAD22 GJ (Suffix Code) specifies:
#20 AWG wire; LS = 0.375"; Inside Crimp; Short Cut Lead Length.

100 V _{DC} TO 1000 V _{DC} CAPACITORS			SUFFIX CODES FOR VARIOUS LEAD SPACING (LS) AND WIRE SIZE (AWG) VOLT CAPACITORS						
Wire form Description	Fig.	Lead Length	0.200" (5.0)		0.250" (6.3)		0.300" (7.5)	0.375" (9.5)	0.400" (10.0)
			#22 AWG	#24 AWG	#22 AWG	#24 AWG	#22 AWG	#22 AWG	#22 AWG
Straight wire	Fig.11	Long 'LL'	MA	PA	UB	UA	BK	BJ	BL
Steeple wire	Fig.12	Long 'LL' Cut 'CL'	CL	PT	CJ	CH	CA	CK	CB
			NB	PK	NK	NG	NC	ND	NE
Step wire	Fig.14	Long 'LL' Cut 'CL'	VD	VK	VB	PQ	VF	VG	VH
			PG	PU	PR	PL	PH	PS	PJ
Inside crimp	Fig.15	Long 'LL' Cut 'CL'	JQ	JT	JC	JF	JL	JS	JP
			JA	JD	JK	JY	JR	JJ	JB

2 kV _{DC} TO 3 kV _{DC} CAPACITORS			SUFFIX CODES FOR VARIOUS LEAD SPACING (LS) AND WIRE SIZE (AWG) VOLT CAPACITORS										
Wire form Description	Fig.	Lead Length	0.250" (6.3)		0.300" (7.5)		0.375" (9.5)		0.400" (10.0)		0.500" (12.7)		0.750" (19)
			#20 AWG	#22 AWG	#20 AWG	#22 AWG	#20 AWG	#22 AWG	#20 AWG	#22 AWG	#20 AWG	#22 AWG	#20 AWG
Straight wire	Fig.11	Long 'LL'	AA	UB	AE	BK	AJ	BJ	AD	BL	AM	BM	AB
Inline wire	Fig.13	Long 'LL' Cut 'CL'	XW	XY	UC	UE	UG	UJ	UL	UM	UQ	US	-
			XX	XZ	DU	UF	UH	UK	UN	UP	UR	UT	-
Inside crimp	Fig.15	Long 'LL' Cut 'CL'	GB	JC	GC	JL	GN	JS	GD	JP	GF	JN	-
			GE	JK	JH	JR	GJ	JJ	JG	JB	GM	JM	-

Notes

- Popular wire lead form options are described above; consult factory for other available forms.
- Practical consideration may limit wire options depending on capacitor size - verify special requirements with factory.

WIRE INFORMATION	
#20 AWG	0.032" (0.81) Copper Wire
#22 AWG	0.025" (0.64) Copper Wire
#24 AWG	0.020" (0.51) Copper Clad Steel Wire

LEAD LENGTH INFORMATION
<ul style="list-style-type: none"> • Standard Long Lead "LL" Length = 1.250" (32 mm) minimum • Cut Lead "CL" Length may be user specified; if unspecified, Vishay Cera-Mite supplies 0.187" (4.8 mm) EIA standard • Cut Lead Lengths are measured from bottom of wire seating plane (wire support point on circuit board) • Minimum Cut Lead Lengths "CL min" are contained in wire figures 12 thru 15 • Cut Lead Length Tolerance: + 0.031"/- 0.015" (0.8/- 0.4 mm)

STANDARD LEAD CONFIGURATIONS

Straight Fig. 11

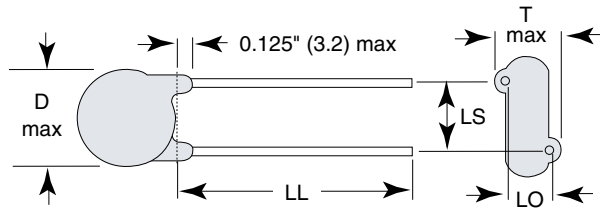

Step Low Voltage Fig. 14

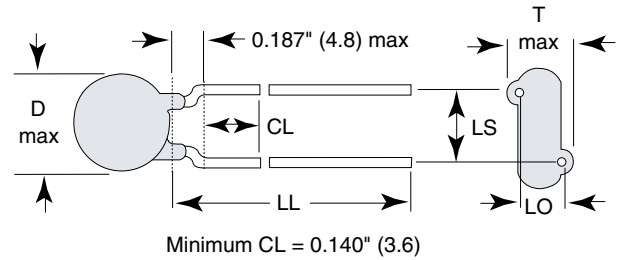

Steeple Fig. 12

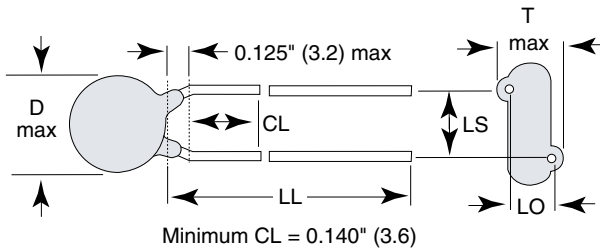

Inside Crimp Fig. 15

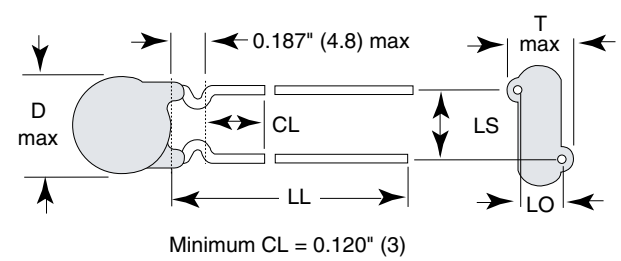

Inline Fig. 13

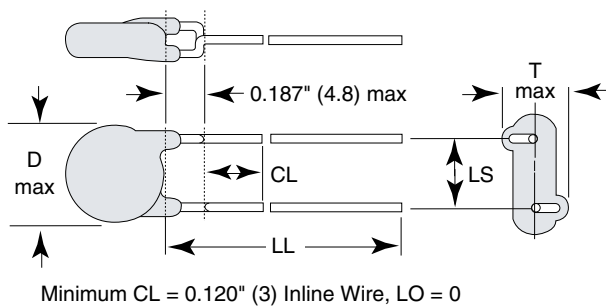

General Information



Vishay Cera-Mite

Ceramic DC Disc, RFI and Safety Capacitors

PACKAGING OPTIONS

Parts will be BULK packaged in cartons or plastic bags unless optional packaging is specified. Consult factory for other packaging options such as TAPED and REELED or AMMOPACK.

TAPE AND REEL OPTIONS

Radial leaded parts may be ordered with Tape and Reel packaging by adding appropriate suffix code to part number. Example: 562R5GAS10QR (Suffix Code) specifies: #22 AWG wire; Straight Lead Form; LS = 5 mm; Tape and Reel per EIA 468B.

TAPE AND REEL PACKAGING PART NUMBER SUFFIX				TAPE AND REEL SUFFIX CODES FOR VARIOUS WIRE FORMS & SIZES												
T & R Figure	LS (mm)	Max. Disc Diameter (in) (mm)		T & R Standard Fig.16	Straight wire Figure 11			Steeple wire Figure 12		Inline wire Figure 13		Step wire Figure 14		Inside crimp wire Figure 15		
		#20 AWG	#22 AWG		#24 AWG	#22 AWG	#24 AWG	#20 AWG	#22 AWG	#22 AWG	#24 AWG	#20 AWG	#22 AWG	#24 AWG		
A	5.0	0.490	12.4	C-M	QG	QA	QB	TK	WK	XA	ZA	VC	VQ	RA	RE	RB
				EIA	QH	QR	QD	TR	TX	XB	XN	VZ	VE	RC	RR	LA
B	7.5	0.530	13.5	C-M	QP	QK	-	-	-	XG	ZC	-	-	RP	RK	-
				EIA	QS	QF	-	-	-	XH	XR	-	-	RX	RL	-
C	10.5	0.708	18.0	C-M	QQ	QM	-	-	-	XJ	XS	-	-	RQ	RM	-
				EIA	AP	QX	-	-	-	XK	XT	-	-	RJ	RU	-
D	7.5	0.708	18.0	C-M	QW	QN	-	-	-	XL	XU	-	-	RW	RN	-
				EIA	AQ	QE	-	-	-	XM	XV	-	-	RV	RD	-

WIRE INFORMATION

#20 AWG	0.032" (0.81) Copper Wire
#22 AWG	0.025" (0.64) Copper Wire
#24 AWG	0.020" (0.51) Copper Clad Steel Wire

REELING STANDARD CERA-MITE vs. EIA-468B

EIA lead spacings for tape and reel are based on multiples of 0.100" (2.5 mm) to coordinate with automatic insertion machinery and boards using 0.100" grid convention

Fig. 16 - Vishay Cera-Mite standard is a reverse reeled version of EIA 468B

VISHAY CERA-MITE STANDARD
Suffix QA RE TK

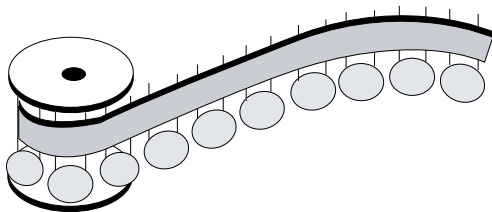

EIA-468B STANDARD
Suffix QR RR TR

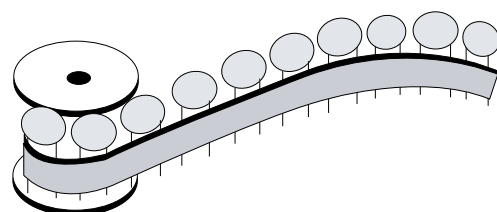

TAPE AND REEL OPTIONS

Fig. A

Lead Space LS	5.0 mm
Pitch	0.5" (12.7 mm)
Available Series	
Disc Diameter	12.4 mm or less
Series	100 V _{DC} to 3 kV _{DC}

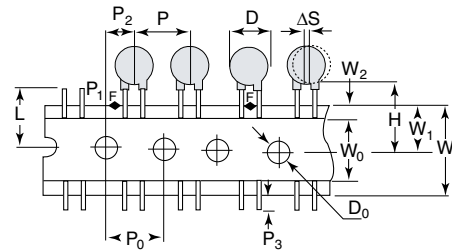

Fig. B

Lead Space LS	7.5 mm
Pitch	(15.0 mm)
Available Series	
Disc Diameter	13.5 mm or less
Series	100 V _{DC} to 3 kV _{DC} and AC Rated Caps

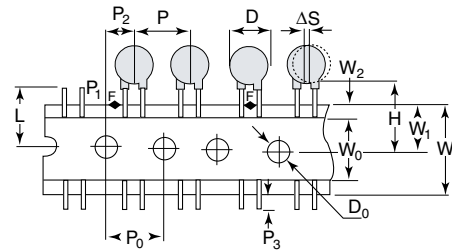

Fig. C

Lead Space LS	10.0 mm
Pitch	1.0" (25.4 mm)
Available Series	
Disc Diameter	18.0 mm or less
Series	100 kV _{DC} to 6 kV _{DC} and AC Rated Caps

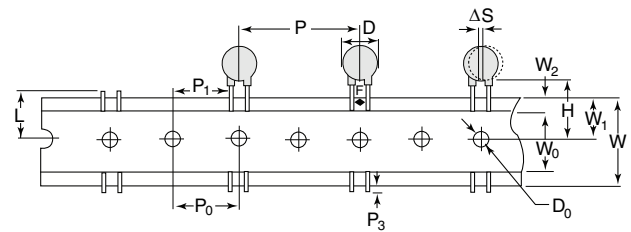
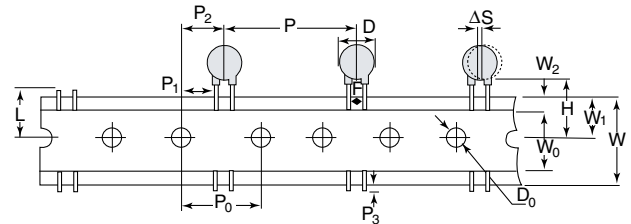

Fig. D

Lead Space LS	7.5 mm
Pitch	30.0 mm
Available Series	
Disc Diameter	18.0 mm or less
Series	100 V _{DC} to 6 kV _{DC} and AC Rated Caps



General Information

Vishay Cera-Mite

Ceramic DC Disc, RFI and Safety Capacitors



TAPE AND REEL OPTIONS					
ITEM	CODE	Fig. A	Fig. B	Fig. C	Fig. D
		Dimensions (mm)			
Pitch of component	P	12.7	15.0	25.4	30.0
Pitch of sprocket hole	P ₀	12.7 ± 0.3	15.0 ± 0.3	12.7 ± 0.4	15.0 ± 0.4
Lead spacing	F	5.0 + 0.8/- 0.2	7.5 ± 1.0	10.0 ± 1.0	7.5 ± 1.0
Length from hole center to component center	P ₂	6.35 ± 1.3	7.5 ± 1.5	-	7.5 ± 1.5
Length from hole center to component lead	P ₁	3.85 ± 0.7	3.75 ± 1.0	7.7 ± 1.5	3.75 ± 1.0
Disc Diameter	D	See individual product specification			
Deviation along tape, left/right	ΔS	0 ± 1.3	0 ± 2.0		
Component alignment	Δh	0 ± 1.0			
Carrier Tape width	W	18.0 ± 0.5			
Position of sprocket hole	W ₁	9.0 - 0.5/+ 0.75			
Height to component body (Lead Fig. 11)	H	20.0 + 1.5/- 1.0	20.0 + 1.5/- 1.0	18.0 + 2.0/- 1.0	20.0 + 1.5/- 1.0
Height to seating plane (Lead Fig. 12 to 15)	H	16.0 ± 0.5			
Protrusion Length	P ₃	3.0 max.			
Diameter of Sprocket hole	D ₀	4.0 ± 0.2			
Total Tape thickness	t ₁	0.6 ± 0.3			
Total thickness, Tape & Lead wire	t ₂	1.5 max.			
Portion to cut	L	11.0 max.			
Hold down Tape width	W ₀	11.5 max.			
Hold down Tape position	W ₂	1.5 ± 1.5			

PACKAGING OPTIONS

Reel Packaging

Ammo Packaging

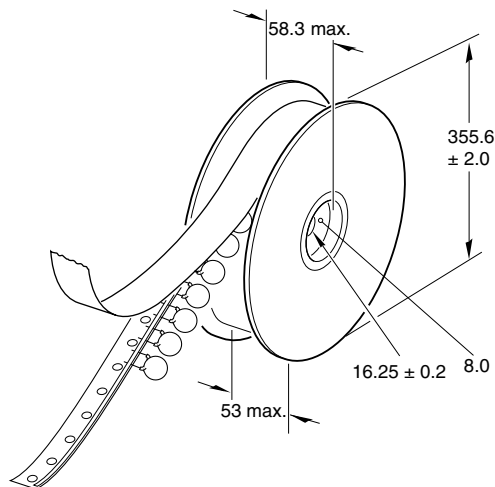

Consult us for other packaging options, such as ammo pack cartons.



ORDERING CODE CATALOGUE PART NUMBER DC CAPACITORS					
564R	5	GA	D	68	VJ
SERIES	RATED VOLTAGE	CERAMIC CODE	CAPACITANCE VALUE		WIRE/TAPE OPTIONS
			DIVIDER	VALUE	
561R All Class 1 Dielectric and 1000 V _{DC} Precision and 1 kV _{DC} Low DF	none = 100 V 1 = 1000 V 2 = 2000 V 3 = 3000 V 5 = 500 V	See on the individual Datasheets	'Quad' = Q 'Triple' = T 'Double' = D 'Single' = S	the two digits are the significant figures of the Capacitance	(Optional)
562R General purpose 100 V _{DC} thru 1000 V _{DC} Class 2 Dielectric	10 = 1 kV _{DC} 20 = 2 kV _{DC} 30 = 3 kV _{DC} 60 = 6 kV _{DC} 75 = 7.5 kV _{DC} 100 = 10 kV _{DC} 150 = 15 kV _{DC}		Number of zeros following the Decimal point of the Capacitance value e.g. 0.000068 = 68 pF 0.00068 = 680 pF 0.0068 = 6800 pF 0.068 = 68 000 pF		
565R Dual Parallel Discs					
564R High voltage 2 kV _{DC} thru 7.5 kV _{DC}					
615R High voltage 10 kV _{DC} thru 15 kV _{DC}					
R' indicates an RoHS compliant component					

ORDERING CODE CATALOGUE PART NUMBER AC LINE RATED CAPACITORS				
440L	S	10	AM	-R
SERIES	CAPACITANCE VALUE		WIRE/TAPE OPTIONS	ROHS
	DIVIDER	VALUE		
440L X1/Y1 Safety Approved	'Quad' = Q 'Triple' = T 'Double' = D 'Single' = S Number of zeros following the Decimal point of the Capacitance value e.g. 0.00001 = 10 pF 0.0001 = 100 pF 0.001 = 1000 pF 0.01 = 10 000 pF Basis is the Capacitance given in µF	the two digits are the significant figures of the Capacitance	(Optional)	'R' indicates an RoHS compliant component
30LV X1/Y2 Safety Approved				
30LVSX1/Y2 Safety Approved				
25Y X1/Y2 Safety Approved				
125L X1/Y4 Safety Approved				
20VL X2 EMI Filter				

General Information



Vishay Cera-Mite

Ceramic DC Disc, RFI and Safety Capacitors

ORDERING CODE CUSTOM PART PART NUMBER							
564R	Y5P	JR	303	E	E	680	K
SERIES	TEMP. CHARACT.	WIRE LEAD AND PACKAGING CODE	RATED VOLTAGE	COATING MATERIAL	BODY SIZE	CAPACITANCE VALUE	TOL.
561R All Class 1 Dielectric and 1000 V _{DC} Precision and 1 kV _{DC} Low DF	see Table on page 4 and on individual datasheets	see Table on pages 14 to 16	First two digits are significant numbers Last digit specifies the numbers of zeros (Voltage given in 'Volts')	E = Epoxy A = Phenolic	Disc diameter code Letter	First two digits are significant numbers Last digit specifies the numbers of zeros For values below 10 pF, use Letter 'R' For values decimal point e.g. 2R2 = 2.2 pF	see Table on page 4
562R General purpose 100 V _{DC} thru 1000 V _{DC} Class 2 Dielectric							
565R Dual Parallel Discs							
564R High voltage 2 kV _{DC} thru 7.5 kV _{DC}							
615R High voltage 10 kV _{DC} thru 15 kV _{DC}							
R' indicates an RoHS compliant component							

CUSTOM DESIGNS

Vishay Cera-Mite's most popular 100 Volt to 15 000 Volt values and constructions are shown as standard part numbers in this catalog. Many other values and lead styles are available. Other capacitance ranges and styles are available on request. Various wire lead forms and packaging options are detailed on the previous pages. Part numbers for custom capacitors consist of an 18-character designator assigned by our application engineering group. Vishay Cera-Mite will provide a certified outline drawing and complete part number covering custom options specified. Customer approval of the outline is usually requested to guarantee satisfaction. All performance characteristics shown in this catalog apply to the options unless otherwise stated on the outline drawing.

MARKING INFORMATION				
CM	Y5R (OR C)	01	M	1 KV
MANUFACTURER IDENTIFICATION	TEMPERATURE COEFFICIENT	CAPACITANCE	CAPACITANCE TOLERANCE	VOLTAGE
"Cera-Mite®" or the identification "CM"	See chart on page 4	Expressed in pF or μF. Example: 680 = 680 pF 0047 = 0.0047 μF	C = ± 0.25 pF D = ± 0.5 pF J = ± 5 % K = ± 10 % M = ± 20 % P = + 100 % to - 0 % Y = - 20 % to + 50 % Z = - 20 % to + 80 %	Rating normally DC volts. AC voltage rating marked AC or ~; If no voltage is marked, part is 500 V _{DC}

Notes

- Wire lead DC rated, disc capacitors are marked with a code identifying the manufacturer, capacitance, tolerance, voltage, and type of ceramic.
- Specially types such as AC rated are marked as described on the individual datasheets.