

Spartan-3E Libraries Guide for Schematic Designs

UG618 (v14.7) October 2, 2013



Notice of Disclaimer

The information disclosed to you hereunder (the "Materials") is provided solely for the selection and use of Xilinx products. To the maximum extent permitted by applicable law: (1) Materials are made available "AS IS" and with all faults, Xilinx hereby DISCLAIMS ALL WARRANTIES AND CONDITIONS, EXPRESS, IMPLIED, OR STATUTORY, INCLUDING BUT NOT LIMITED TO WARRANTIES OF MERCHANTABILITY, NON-INFRINGEMENT, OR FITNESS FOR ANY PARTICULAR PURPOSE; and (2) Xilinx shall not be liable (whether in contract or tort, including negligence, or under any other theory of liability) for any loss or damage of any kind or nature related to, arising under, or in connection with, the Materials (including your use of the Materials), including for any direct, indirect, special, incidental, or consequential loss or damage (including loss of data, profits, goodwill, or any type of loss or damage suffered as a result of any action brought by a third party) even if such damage or loss was reasonably foreseeable or Xilinx had been advised of the possibility of the same. Xilinx assumes no obligation to correct any errors contained in the Materials or to notify you of updates to the Materials or to product specifications. You may not reproduce, modify, distribute, or publicly display the Materials without prior written consent. Certain products are subject to the terms and conditions of the Limited Warranties which can be viewed at <http://www.xilinx.com/warranty.htm>; IP cores may be subject to warranty and support terms contained in a license issued to you by Xilinx. Xilinx products are not designed or intended to be fail-safe or for use in any application requiring fail-safe performance; you assume sole risk and liability for use of Xilinx products in Critical Applications: <http://www.xilinx.com/warranty.htm#critapps>.

© Copyright 2002-2013 Xilinx Inc. All rights reserved. Xilinx, the Xilinx logo, Artix, ISE, Kintex, Spartan, Virtex, Vivado, Zynq, and other designated brands included herein are trademarks of Xilinx in the United States and other countries. All other trademarks are the property of their respective owners.

Introduction

This schematic guide is part of the ISE documentation collection. A separate version of this guide is available if you prefer to work with HDL.

This guide contains the following:

- Introduction.
- A list of design elements supported in this architecture, organized by functional categories.
- Individual descriptions of each available primitive.

About Design Elements

This version of the Libraries Guide describes design elements available for Spartan®-3E devices. There are several categories of design elements:

- **Primitives** - The simplest design elements in the Xilinx libraries. Primitives are the design element "atoms." Examples of Xilinx primitives are the simple buffer, BUF, and the D flip-flop with clock enable and clear, FDCE.
- **Macros** - The design element "molecules" of the Xilinx libraries. Macros can be created from the design element primitives or macros. For example, the FD4CE flip-flop macro is a composite of 4 FDCE primitives.

Xilinx maintains software libraries with hundreds of functional design elements (macros and primitives) for different device architectures. New functional elements are assembled with each release of development system software. This guide is one in a series of architecture-specific libraries.

Functional Categories

This section categorizes, by function, the circuit design elements described in detail later in this guide. The elements (*primitives* and *macros*) are listed in alphanumeric order under each functional category.

Arithmetic	Flip Flop	LUT
Buffer	General	Memory
Carry Logic	IO	Mux
Comparator	IO FlipFlop	Shift Register
Counter	IO Latch	Shifter
DDR Flip Flop	Latch	
Decoder	Logic	

Arithmetic

Design Element	Description
ACC16	Macro: 16-Bit Loadable Cascadable Accumulator with Carry-In, Carry-Out, and Synchronous Reset
ACC4	Macro: 4-Bit Loadable Cascadable Accumulator with Carry-In, Carry-Out, and Synchronous Reset
ACC8	Macro: 8-Bit Loadable Cascadable Accumulator with Carry-In, Carry-Out, and Synchronous Reset
ADD16	Macro: 16-Bit Cascadable Full Adder with Carry-In, Carry-Out, and Overflow
ADD4	Macro: 4-Bit Cascadable Full Adder with Carry-In, Carry-Out, and Overflow
ADD8	Macro: 8-Bit Cascadable Full Adder with Carry-In, Carry-Out, and Overflow
ADSU16	Macro: 16-Bit Cascadable Adder/Subtractor with Carry-In, Carry-Out, and Overflow
ADSU4	Macro: 4-Bit Cascadable Adder/Subtractor with Carry-In, Carry-Out, and Overflow
ADSU8	Macro: 8-Bit Cascadable Adder/Subtractor with Carry-In, Carry-Out, and Overflow

Design Element	Description
MULT18X18	Primitive: 18 x 18 Signed Multiplier
MULT18X18S	Primitive: 18 x 18 Signed Multiplier -- Registered Version
MULT18X18SIO	Primitive: 18 x 18 Cascadable Signed Multiplier with Optional Input and Output Registers, Clock Enable, and Synchronous Reset

Buffer

Design Element	Description
BUF	Primitive: General Purpose Buffer
BUFCF	Primitive: Fast Connect Buffer
BUFG	Primitive: Global Clock Buffer
BUFGCE	Primitive: Global Clock Buffer with Clock Enable
BUFGCE_1	Primitive: Global Clock Buffer with Clock Enable and Output State 1
BUFGMUX	Primitive: Global Clock MUX Buffer
BUFGMUX_1	Primitive: Global Clock MUX Buffer with Output State 1

Carry Logic

Design Element	Description
MUXCY	Primitive: 2-to-1 Multiplexer for Carry Logic with General Output
MUXCY_D	Primitive: 2-to-1 Multiplexer for Carry Logic with Dual Output
MUXCY_L	Primitive: 2-to-1 Multiplexer for Carry Logic with Local Output
XORCY	Primitive: XOR for Carry Logic with General Output
XORCY_D	Primitive: XOR for Carry Logic with Dual Output
XORCY_L	Primitive: XOR for Carry Logic with Local Output

Comparator

Design Element	Description
COMP16	Macro: 16-Bit Identity Comparator
COMP2	Macro: 2-Bit Identity Comparator
COMP4	Macro: 4-Bit Identity Comparator
COMP8	Macro: 8-Bit Identity Comparator
COMPM16	Macro: 16-Bit Magnitude Comparator
COMPM2	Macro: 2-Bit Magnitude Comparator
COMPM4	Macro: 4-Bit Magnitude Comparator
COMPM8	Macro: 8-Bit Magnitude Comparator
COMPMC16	Macro: 16-Bit Magnitude Comparator
COMPMC8	Macro: 8-Bit Magnitude Comparator

Counter

Design Element	Description
CB16CE	Macro: 16-Bit Cascadable Binary Counter with Clock Enable and Asynchronous Clear
CB16CLE	Macro: 16-Bit Loadable Cascadable Binary Counters with Clock Enable and Asynchronous Clear
CB16CLED	Macro: 16-Bit Loadable Cascadable Bidirectional Binary Counters with Clock Enable and Asynchronous Clear
CB16RE	Macro: 16-Bit Cascadable Binary Counter with Clock Enable and Synchronous Reset
CB2CE	Macro: 2-Bit Cascadable Binary Counter with Clock Enable and Asynchronous Clear
CB2CLE	Macro: 2-Bit Loadable Cascadable Binary Counters with Clock Enable and Asynchronous Clear
CB2CLED	Macro: 2-Bit Loadable Cascadable Bidirectional Binary Counters with Clock Enable and Asynchronous Clear
CB2RE	Macro: 2-Bit Cascadable Binary Counter with Clock Enable and Synchronous Reset
CB4CE	Macro: 4-Bit Cascadable Binary Counter with Clock Enable and Asynchronous Clear
CB4CLE	Macro: 4-Bit Loadable Cascadable Binary Counters with Clock Enable and Asynchronous Clear
CB4CLED	Macro: 4-Bit Loadable Cascadable Bidirectional Binary Counters with Clock Enable and Asynchronous Clear
CB4RE	Macro: 4-Bit Cascadable Binary Counter with Clock Enable and Synchronous Reset
CB8CE	Macro: 8-Bit Cascadable Binary Counter with Clock Enable and Asynchronous Clear
CB8CLE	Macro: 8-Bit Loadable Cascadable Binary Counters with Clock Enable and Asynchronous Clear
CB8CLED	Macro: 8-Bit Loadable Cascadable Bidirectional Binary Counters with Clock Enable and Asynchronous Clear
CB8RE	Macro: 8-Bit Cascadable Binary Counter with Clock Enable and Synchronous Reset
CC16CE	Macro: 16-Bit Cascadable Binary Counter with Clock Enable and Asynchronous Clear
CC16CLE	Macro: 16-Bit Loadable Cascadable Binary Counter with Clock Enable and Asynchronous Clear
CC16CLED	Macro: 16-Bit Loadable Cascadable Bidirectional Binary Counter with Clock Enable and Asynchronous Clear
CC16RE	Macro: 16-Bit Cascadable Binary Counter with Clock Enable and Synchronous Reset
CC8CE	Macro: 8-Bit Cascadable Binary Counter with Clock Enable and Asynchronous Clear
CC8CLE	Macro: 8-Bit Loadable Cascadable Binary Counter with Clock Enable and Asynchronous Clear
CC8CLED	Macro: 8-Bit Loadable Cascadable Bidirectional Binary Counter with Clock Enable and Asynchronous Clear

Design Element	Description
CC8RE	Macro: 8-Bit Cascadable Binary Counter with Clock Enable and Synchronous Reset
CD4CE	Macro: 4-Bit Cascadable BCD Counter with Clock Enable and Asynchronous Clear
CD4CLE	Macro: 4-Bit Loadable Cascadable BCD Counter with Clock Enable and Asynchronous Clear
CD4RE	Macro: 4-Bit Cascadable BCD Counter with Clock Enable and Synchronous Reset
CD4RLE	Macro: 4-Bit Loadable Cascadable BCD Counter with Clock Enable and Synchronous Reset
CJ4CE	Macro: 4-Bit Johnson Counter with Clock Enable and Asynchronous Clear
CJ4RE	Macro: 4-Bit Johnson Counter with Clock Enable and Synchronous Reset
CJ5CE	Macro: 5-Bit Johnson Counter with Clock Enable and Asynchronous Clear
CJ5RE	Macro: 5-Bit Johnson Counter with Clock Enable and Synchronous Reset
CJ8CE	Macro: 8-Bit Johnson Counter with Clock Enable and Asynchronous Clear
CJ8RE	Macro: 8-Bit Johnson Counter with Clock Enable and Synchronous Reset
CR16CE	Macro: 16-Bit Negative-Edge Binary Ripple Counter with Clock Enable and Asynchronous Clear
CR8CE	Macro: 8-Bit Negative-Edge Binary Ripple Counter with Clock Enable and Asynchronous Clear

DDR Flip Flop

Design Element	Description
IDDR2	Primitive: Double Data Rate Input D Flip-Flop with Optional Data Alignment, Clock Enable and Programmable Synchronous or Asynchronous Set/Reset
ODDR2	Primitive: Dual Data Rate Output D Flip-Flop with Optional Data Alignment, Clock Enable and Programmable Synchronous or Asynchronous Set/Reset

Decoder

Design Element	Description
D2_4E	Macro: 2- to 4-Line Decoder/Demultiplexer with Enable
D3_8E	Macro: 3- to 8-Line Decoder/Demultiplexer with Enable
D4_16E	Macro: 4- to 16-Line Decoder/Demultiplexer with Enable
DEC_CC16	Macro: 16-Bit Active Low Decoder
DEC_CC4	Macro: 4-Bit Active Low Decoder
DEC_CC8	Macro: 8-Bit Active Low Decoder
DECODE16	Macro: 16-Bit Active-Low Decoder

Design Element	Description
DECODE32	Macro: 32-Bit Active-Low Decoder
DECODE4	Macro: 4-Bit Active-Low Decoder
DECODE64	Macro: 64-Bit Active-Low Decoder
DECODE8	Macro: 8-Bit Active-Low Decoder

Flip Flop

Design Element	Description
FD	Primitive: D Flip-Flop
FD_1	Primitive: D Flip-Flop with Negative-Edge Clock
FD16CE	Macro: 16-Bit Data Register with Clock Enable and Asynchronous Clear
FD16RE	Macro: 16-Bit Data Register with Clock Enable and Synchronous Reset
FD4CE	Macro: 4-Bit Data Register with Clock Enable and Asynchronous Clear
FD4RE	Macro: 4-Bit Data Register with Clock Enable and Synchronous Reset
FD8CE	Macro: 8-Bit Data Register with Clock Enable and Asynchronous Clear
FD8RE	Macro: 8-Bit Data Register with Clock Enable and Synchronous Reset
FDC	Primitive: D Flip-Flop with Asynchronous Clear
FDC_1	Primitive: D Flip-Flop with Negative-Edge Clock and Asynchronous Clear
FDCE	Primitive: D Flip-Flop with Clock Enable and Asynchronous Clear
FDCE_1	Primitive: D Flip-Flop with Negative-Edge Clock, Clock Enable, and Asynchronous Clear
FDCP	Primitive: D Flip-Flop with Asynchronous Preset and Clear
FDCP_1	Primitive: D Flip-Flop with Negative-Edge Clock and Asynchronous Preset and Clear
FDCPE	Primitive: D Flip-Flop with Clock Enable and Asynchronous Preset and Clear
FDCPE_1	Primitive: D Flip-Flop with Negative-Edge Clock, Clock Enable, and Asynchronous Preset and Clear
FDE	Primitive: D Flip-Flop with Clock Enable
FDE_1	Primitive: D Flip-Flop with Negative-Edge Clock and Clock Enable
FDP	Primitive: D Flip-Flop with Asynchronous Preset
FDP_1	Primitive: D Flip-Flop with Negative-Edge Clock and Asynchronous Preset
FDPE	Primitive: D Flip-Flop with Clock Enable and Asynchronous Preset

Design Element	Description
FDPE_1	Primitive: D Flip-Flop with Negative-Edge Clock, Clock Enable, and Asynchronous Preset
FDR	Primitive: D Flip-Flop with Synchronous Reset
FDR_1	Primitive: D Flip-Flop with Negative-Edge Clock and Synchronous Reset
FDRE	Primitive: D Flip-Flop with Clock Enable and Synchronous Reset
FDRE_1	Primitive: D Flip-Flop with Negative-Clock Edge, Clock Enable, and Synchronous Reset
FDRS	Primitive: D Flip-Flop with Synchronous Reset and Set
FDRS_1	Primitive: D Flip-Flop with Negative-Clock Edge and Synchronous Reset and Set
FDRSE	Primitive: D Flip-Flop with Synchronous Reset and Set and Clock Enable
FDRSE_1	Primitive: D Flip-Flop with Negative-Clock Edge, Synchronous Reset and Set, and Clock Enable
FDS	Primitive: D Flip-Flop with Synchronous Set
FDS_1	Primitive: D Flip-Flop with Negative-Edge Clock and Synchronous Set
FDSE	Primitive: D Flip-Flop with Clock Enable and Synchronous Set
FDSE_1	Primitive: D Flip-Flop with Negative-Edge Clock, Clock Enable, and Synchronous Set
FJKC	Macro: J-K Flip-Flop with Asynchronous Clear
FJKCE	Macro: J-K Flip-Flop with Clock Enable and Asynchronous Clear
FJKP	Macro: J-K Flip-Flop with Asynchronous Preset
FJKPE	Macro: J-K Flip-Flop with Clock Enable and Asynchronous Preset
FJKRSE	Macro: J-K Flip-Flop with Clock Enable and Synchronous Reset and Set
FJKSRE	Macro: J-K Flip-Flop with Clock Enable and Synchronous Set and Reset
FTC	Macro: Toggle Flip-Flop with Asynchronous Clear
FTCE	Macro: Toggle Flip-Flop with Clock Enable and Asynchronous Clear
FTCLE	Macro: Toggle/Loadable Flip-Flop with Clock Enable and Asynchronous Clear
FTCLEX	Macro: Toggle/Loadable Flip-Flop with Clock Enable and Asynchronous Clear
FTP	Macro: Toggle Flip-Flop with Asynchronous Preset
FTPE	Macro: Toggle Flip-Flop with Clock Enable and Asynchronous Preset
FTPLE	Macro: Toggle/Loadable Flip-Flop with Clock Enable and Asynchronous Preset

Design Element	Description
FTRSE	Macro: Toggle Flip-Flop with Clock Enable and Synchronous Reset and Set
FTRSLE	Macro: Toggle/Loadable Flip-Flop with Clock Enable and Synchronous Reset and Set
FTSRE	Macro: Toggle Flip-Flop with Clock Enable and Synchronous Set and Reset
FTSRLE	Macro: Toggle/Loadable Flip-Flop with Clock Enable and Synchronous Set and Reset

General

Design Element	Description
BSCAN_SPARTAN3	Primitive: Spartan®-3 and Spartan-3E JTAG Boundary Scan Logic Access Circuit
CAPTURE_SPARTAN3	Primitive: Spartan®-3 Register State Capture for Bitstream Readback
DCM_SP	Primitive: Digital Clock Manager
GND	Primitive: Ground-Connection Signal Tag
KEEPER	Primitive: KEEPER Symbol
PULLDOWN	Primitive: Resistor to GND for Input Pads, Open-Drain, and 3-State Outputs
PULLUP	Primitive: Resistor to VCC for Input PADS, Open-Drain, and 3-State Outputs
STARTUP_SPARTAN3E	Primitive: Spartan®-3E User Interface to the GSR, GTS, Configuration Startup Sequence and Multi-Boot Trigger Circuitry
VCC	Primitive: VCC-Connection Signal Tag

IO

Design Element	Description
IBUF	Primitive: Input Buffer
IBUFDS	Primitive: Differential Signaling Input Buffer
IBUF16	Macro: 16-Bit Input Buffer
IBUF4	Macro: 4-Bit Input Buffer
IBUF8	Macro: 8-Bit Input Buffer
IBUFG	Primitive: Dedicated Input Clock Buffer
IBUFGDS	Primitive: Differential Signaling Dedicated Input Clock Buffer and Optional Delay
IOBUF	Primitive: Bi-Directional Buffer
IOBUFGDS	Primitive: 3-State Differential Signaling I/O Buffer with Active Low Output Enable
OBUF	Primitive: Output Buffer
OBUF16	Macro: 16-Bit Output Buffer
OBUF8	Macro: 8-Bit Output Buffer

Design Element	Description
OBUF4	Macro: 4-Bit Output Buffer
OBUFDS	Primitive: Differential Signaling Output Buffer
OBUFT	Primitive: 3-State Output Buffer with Active Low Output Enable
OBUFT4	Macro: 4-Bit 3-State Output Buffers with Active-Low Output Enable
OBUFT8	Macro: 8-Bit 3-State Output Buffers with Active-Low Output Enable
OBUFT16	Macro: 16-Bit 3-State Output Buffer with Active Low Output Enable
OBUFTDS	Primitive: 3-State Output Buffer with Differential Signaling, Active-Low Output Enable

IO FlipFlop

Design Element	Description
IFD	Macro: Input D Flip-Flop
IFD_1	Macro: Input D Flip-Flop with Inverted Clock (Asynchronous Preset)
IFD16	Macro: 16-Bit Input D Flip-Flop
IFD4	Macro: 4-Bit Input D Flip-Flop
IFD8	Macro: 8-Bit Input D Flip-Flop
IFDI	Macro: Input D Flip-Flop (Asynchronous Preset)
IFDI_1	Macro: Input D Flip-Flop with Inverted Clock (Asynchronous Preset)
IFDX	Macro: Input D Flip-Flop with Clock Enable
IFDX_1	Macro: Input D Flip-Flop with Inverted Clock and Clock Enable
IFDX16	Macro: 16-Bit Input D Flip-Flops with Clock Enable
IFDX4	Macro: 4-Bit Input D Flip-Flop with Clock Enable
IFDX8	Macro: 8-Bit Input D Flip-Flop with Clock Enable
IFDXI	Macro: Input D Flip-Flop with Clock Enable (Asynchronous Preset)
IFDXI_1	Macro: Input D Flip-Flop with Inverted Clock and Clock Enable (Asynchronous Preset)
OFD	Macro: Output D Flip-Flop
OFD_1	Macro: Output D Flip-Flop with Inverted Clock
OFD16	Macro: 16-Bit Output D Flip-Flop
OFD4	Macro: 4-Bit Output D Flip-Flop
OFD8	Macro: 8-Bit Output D Flip-Flop
OFDE	Macro: D Flip-Flop with Active-High Enable Output Buffers
OFDE_1	Macro: D Flip-Flop with Active-High Enable Output Buffer and Inverted Clock

Design Element	Description
OFDE16	Macro: 16-Bit D Flip-Flop with Active-High Enable Output Buffers
OFDE4	Macro: 4-Bit D Flip-Flop with Active-High Enable Output Buffers
OFDE8	Macro: 8-Bit D Flip-Flop with Active-High Enable Output Buffers
OFDI	Macro: Output D Flip-Flop (Asynchronous Preset)
OFDI_1	Macro: Output D Flip-Flop with Inverted Clock (Asynchronous Preset)
OFDT	Macro: D Flip-Flop with Active-Low 3-State Output Buffer
OFDT_1	Macro: D Flip-Flop with Active-Low 3-State Output Buffer and Inverted Clock
OFDT16	Macro: 16-Bit D Flip-Flop with Active-Low 3-State Output Buffers
OFDT4	Macro: 4-Bit D Flip-Flop with Active-Low 3-State Output Buffers
OFDT8	Macro: 8-Bit D Flip-Flop with Active-Low 3-State Output Buffers
OFDX	Macro: Output D Flip-Flop with Clock Enable
OFDX_1	Macro: Output D Flip-Flop with Inverted Clock and Clock Enable
OFDX16	Macro: 16-Bit Output D Flip-Flop with Clock Enable
OFDX4	Macro: 4-Bit Output D Flip-Flop with Clock Enable
OFDX8	Macro: 8-Bit Output D Flip-Flop with Clock Enable
OFDXI	Macro: Output D Flip-Flop with Clock Enable (Asynchronous Preset)
OFDXI_1	Macro: Output D Flip-Flop with Inverted Clock and Clock Enable (Asynchronous Preset)

IO Latch

Design Element	Description
ILD	Macro: Transparent Input Data Latch
ILD_1	Macro: Transparent Input Data Latch with Inverted Gate
ILD16	Macro: Transparent Input Data Latch
ILD4	Macro: Transparent Input Data Latch
ILD8	Macro: Transparent Input Data Latch
ILDI	Macro: Transparent Input Data Latch (Asynchronous Preset)
ILDI_1	Macro: Transparent Input Data Latch with Inverted Gate (Asynchronous Preset)
ILDY	Macro: Transparent Input Data Latch
ILDY_1	Macro: Transparent Input Data Latch with Inverted Gate
ILDY16	Macro: Transparent Input Data Latch

Design Element	Description
ILD4	Macro: Transparent Input Data Latch
ILD8	Macro: Transparent Input Data Latch
ILD4I	Macro: Transparent Input Data Latch (Asynchronous Preset)
ILD4I_1	Macro: Transparent Input Data Latch with Inverted Gate (Asynchronous Preset)

Latch

Design Element	Description
LD	Primitive: Transparent Data Latch
LD_1	Primitive: Transparent Data Latch with Inverted Gate
LD16	Macro: Multiple Transparent Data Latch
LD4	Macro: Multiple Transparent Data Latch
LD8	Macro: Multiple Transparent Data Latch
LD16CE	Macro: Transparent Data Latch with Asynchronous Clear and Gate Enable
LD4CE	Macro: Transparent Data Latch with Asynchronous Clear and Gate Enable
LD8CE	Macro: Transparent Data Latch with Asynchronous Clear and Gate Enable
LDC	Primitive: Transparent Data Latch with Asynchronous Clear
LDC_1	Primitive: Transparent Data Latch with Asynchronous Clear and Inverted Gate
LDCE	Primitive: Transparent Data Latch with Asynchronous Clear and Gate Enable
LDCE_1	Primitive: Transparent Data Latch with Asynchronous Clear, Gate Enable, and Inverted Gate
LDCP	Primitive: Transparent Data Latch with Asynchronous Clear and Preset
LDCP_1	Primitive: Transparent Data Latch with Asynchronous Clear and Preset and Inverted Gate
LDCPE	Primitive: Transparent Data Latch with Asynchronous Clear and Preset and Gate Enable
LDCPE_1	Primitive: Transparent Data Latch with Asynchronous Clear and Preset, Gate Enable, and Inverted Gate
LDE	Primitive: Transparent Data Latch with Gate Enable
LDE_1	Primitive: Transparent Data Latch with Gate Enable and Inverted Gate
LDP	Primitive: Transparent Data Latch with Asynchronous Preset
LDP_1	Primitive: Transparent Data Latch with Asynchronous Preset and Inverted Gate

Design Element	Description
LDPE	Primitive: Transparent Data Latch with Asynchronous Preset and Gate Enable
LDPE_1	Primitive: Transparent Data Latch with Asynchronous Preset, Gate Enable, and Inverted Gate

Logic

Design Element	Description
AND12	Macro: 12- Input AND Gate with Non-Inverted Inputs
AND16	Macro: 16- Input AND Gate with Non-Inverted Inputs
AND2	Primitive: 2-Input AND Gate with Non-Inverted Inputs
AND2B1	Primitive: 2-Input AND Gate with 1 Inverted and 1 Non-Inverted Inputs
AND2B2	Primitive: 2-Input AND Gate with Inverted Inputs
AND3	Primitive: 3-Input AND Gate with Non-Inverted Inputs
AND3B1	Primitive: 3-Input AND Gate with 1 Inverted and 2 Non-Inverted Inputs
AND3B2	Primitive: 3-Input AND Gate with 2 Inverted and 1 Non-Inverted Inputs
AND3B3	Primitive: 3-Input AND Gate with Inverted Inputs
AND4	Primitive: 4-Input AND Gate with Non-Inverted Inputs
AND4B1	Primitive: 4-Input AND Gate with 1 Inverted and 3 Non-Inverted Inputs
AND4B2	Primitive: 4-Input AND Gate with 2 Inverted and 2 Non-Inverted Inputs
AND4B3	Primitive: 4-Input AND Gate with 3 Inverted and 1 Non-Inverted Inputs
AND4B4	Primitive: 4-Input AND Gate with Inverted Inputs
AND5	Primitive: 5-Input AND Gate with Non-Inverted Inputs
AND5B1	Primitive: 5-Input AND Gate with 1 Inverted and 4 Non-Inverted Inputs
AND5B2	Primitive: 5-Input AND Gate with 2 Inverted and 3 Non-Inverted Inputs
AND5B3	Primitive: 5-Input AND Gate with 3 Inverted and 2 Non-Inverted Inputs
AND5B4	Primitive: 5-Input AND Gate with 4 Inverted and 1 Non-Inverted Inputs
AND5B5	Primitive: 5-Input AND Gate with Inverted Inputs
AND6	Macro: 6-Input AND Gate with Non-Inverted Inputs
AND7	Macro: 7-Input AND Gate with Non-Inverted Inputs
AND8	Macro: 8-Input AND Gate with Non-Inverted Inputs
AND9	Macro: 9-Input AND Gate with Non-Inverted Inputs

Design Element	Description
INV	Primitive: Inverter
INV16	Macro: 16 Inverters
INV4	Macro: Four Inverters
INV8	Macro: Eight Inverters
MULT_AND	Primitive: Fast Multiplier AND
NAND12	Macro: 12- Input NAND Gate with Non-Inverted Inputs
NAND16	Macro: 16- Input NAND Gate with Non-Inverted Inputs
NAND2	Primitive: 2-Input NAND Gate with Non-Inverted Inputs
NAND2B1	Primitive: 2-Input NAND Gate with 1 Inverted and 1 Non-Inverted Inputs
NAND2B2	Primitive: 2-Input NAND Gate with Inverted Inputs
NAND3	Primitive: 3-Input NAND Gate with Non-Inverted Inputs
NAND3B1	Primitive: 3-Input NAND Gate with 1 Inverted and 2 Non-Inverted Inputs
NAND3B2	Primitive: 3-Input NAND Gate with 2 Inverted and 1 Non-Inverted Inputs
NAND3B3	Primitive: 3-Input NAND Gate with Inverted Inputs
NAND4	Primitive: 4-Input NAND Gate with Non-Inverted Inputs
NAND4B1	Primitive: 4-Input NAND Gate with 1 Inverted and 3 Non-Inverted Inputs
NAND4B2	Primitive: 4-Input NAND Gate with 2 Inverted and 2 Non-Inverted Inputs
NAND4B3	Primitive: 4-Input NAND Gate with 3 Inverted and 1 Non-Inverted Inputs
NAND4B4	Primitive: 4-Input NAND Gate with Inverted Inputs
NAND5	Primitive: 5-Input NAND Gate with Non-Inverted Inputs
NAND5B1	Primitive: 5-Input NAND Gate with 1 Inverted and 4 Non-Inverted Inputs
NAND5B2	Primitive: 5-Input NAND Gate with 2 Inverted and 3 Non-Inverted Inputs
NAND5B3	Primitive: 5-Input NAND Gate with 3 Inverted and 2 Non-Inverted Inputs
NAND5B4	Primitive: 5-Input NAND Gate with 4 Inverted and 1 Non-Inverted Inputs
NAND5B5	Primitive: 5-Input NAND Gate with Inverted Inputs
NAND6	Macro: 6-Input NAND Gate with Non-Inverted Inputs
NAND7	Macro: 7-Input NAND Gate with Non-Inverted Inputs
NAND8	Macro: 8-Input NAND Gate with Non-Inverted Inputs
NAND9	Macro: 9-Input NAND Gate with Non-Inverted Inputs
NOR12	Macro: 12-Input NOR Gate with Non-Inverted Inputs
NOR16	Macro: 16-Input NOR Gate with Non-Inverted Inputs
NOR2	Primitive: 2-Input NOR Gate with Non-Inverted Inputs

Design Element	Description
NOR2B1	Primitive: 2-Input NOR Gate with 1 Inverted and 1 Non-Inverted Inputs
NOR2B2	Primitive: 2-Input NOR Gate with Inverted Inputs
NOR3	Primitive: 3-Input NOR Gate with Non-Inverted Inputs
NOR3B1	Primitive: 3-Input NOR Gate with 1 Inverted and 2 Non-Inverted Inputs
NOR3B2	Primitive: 3-Input NOR Gate with 2 Inverted and 1 Non-Inverted Inputs
NOR3B3	Primitive: 3-Input NOR Gate with Inverted Inputs
NOR4	Primitive: 4-Input NOR Gate with Non-Inverted Inputs
NOR4B1	Primitive: 4-Input NOR Gate with 1 Inverted and 3 Non-Inverted Inputs
NOR4B2	Primitive: 4-Input NOR Gate with 2 Inverted and 2 Non-Inverted Inputs
NOR4B3	Primitive: 4-Input NOR Gate with 3 Inverted and 1 Non-Inverted Inputs
NOR4B4	Primitive: 4-Input NOR Gate with Inverted Inputs
NOR5	Primitive: 5-Input NOR Gate with Non-Inverted Inputs
NOR5B1	Primitive: 5-Input NOR Gate with 1 Inverted and 4 Non-Inverted Inputs
NOR5B2	Primitive: 5-Input NOR Gate with 2 Inverted and 3 Non-Inverted Inputs
NOR5B3	Primitive: 5-Input NOR Gate with 3 Inverted and 2 Non-Inverted Inputs
NOR5B4	Primitive: 5-Input NOR Gate with 4 Inverted and 1 Non-Inverted Inputs
NOR5B5	Primitive: 5-Input NOR Gate with Inverted Inputs
NOR6	Macro: 6-Input NOR Gate with Non-Inverted Inputs
NOR7	Macro: 7-Input NOR Gate with Non-Inverted Inputs
NOR8	Macro: 8-Input NOR Gate with Non-Inverted Inputs
NOR9	Macro: 9-Input NOR Gate with Non-Inverted Inputs
OR12	Macro: 12-Input OR Gate with Non-Inverted Inputs
OR16	Macro: 16-Input OR Gate with Non-Inverted Inputs
OR2	Primitive: 2-Input OR Gate with Non-Inverted Inputs
OR2B1	Primitive: 2-Input OR Gate with 1 Inverted and 1 Non-Inverted Inputs
OR2B2	Primitive: 2-Input OR Gate with Inverted Inputs
OR3	Primitive: 3-Input OR Gate with Non-Inverted Inputs
OR3B1	Primitive: 3-Input OR Gate with 1 Inverted and 2 Non-Inverted Inputs
OR3B2	Primitive: 3-Input OR Gate with 2 Inverted and 1 Non-Inverted Inputs
OR3B3	Primitive: 3-Input OR Gate with Inverted Inputs

Design Element	Description
OR4	Primitive: 4-Input OR Gate with Non-Inverted Inputs
OR4B1	Primitive: 4-Input OR Gate with 1 Inverted and 3 Non-Inverted Inputs
OR4B2	Primitive: 4-Input OR Gate with 2 Inverted and 2 Non-Inverted Inputs
OR4B3	Primitive: 4-Input OR Gate with 3 Inverted and 1 Non-Inverted Inputs
OR4B4	Primitive: 4-Input OR Gate with Inverted Inputs
OR5	Primitive: 5-Input OR Gate with Non-Inverted Inputs
OR5B1	Primitive: 5-Input OR Gate with 1 Inverted and 4 Non-Inverted Inputs
OR5B2	Primitive: 5-Input OR Gate with 2 Inverted and 3 Non-Inverted Inputs
OR5B3	Primitive: 5-Input OR Gate with 3 Inverted and 2 Non-Inverted Inputs
OR5B4	Primitive: 5-Input OR Gate with 4 Inverted and 1 Non-Inverted Inputs
OR5B5	Primitive: 5-Input OR Gate with Inverted Inputs
OR6	Macro: 6-Input OR Gate with Non-Inverted Inputs
OR7	Macro: 7-Input OR Gate with Non-Inverted Inputs
OR8	Macro: 8-Input OR Gate with Non-Inverted Inputs
OR9	Macro: 9-Input OR Gate with Non-Inverted Inputs
SOP3	Macro: 3-Input Sum of Products
SOP3B1A	Macro: 3-Input Sum of Products with One Inverted Input (Option A)
SOP3B1B	Macro: 3-Input Sum of Products with One Inverted Input (Option B)
SOP3B2A	Macro: 3-Input Sum of Products with Two Inverted Inputs (Option A)
SOP3B2B	Macro: 3-Input Sum of Products with Two Inverted Inputs (Option B)
SOP3B3	Macro: 3-Input Sum of Products with Inverted Inputs
SOP4	Macro: 4-Input Sum of Products
SOP4B1	Macro: 4-Input Sum of Products with One Inverted Input
SOP4B2A	Macro: 4-Input Sum of Products with Two Inverted Inputs (Option A)
SOP4B2B	Macro: 4-Input Sum of Products with Two Inverted Inputs (Option B)
SOP4B3	Macro: 4-Input Sum of Products with Three Inverted Inputs
SOP4B4	Macro: 4-Input Sum of Products with Inverted Inputs
XNOR2	Primitive: 2-Input XNOR Gate with Non-Inverted Inputs
XNOR3	Primitive: 3-Input XNOR Gate with Non-Inverted Inputs
XNOR4	Primitive: 4-Input XNOR Gate with Non-Inverted Inputs

Design Element	Description
XNOR5	Primitive: 5-Input XNOR Gate with Non-Inverted Inputs
XNOR6	Macro: 6-Input XNOR Gate with Non-Inverted Inputs
XNOR7	Macro: 7-Input XNOR Gate with Non-Inverted Inputs
XNOR8	Macro: 8-Input XNOR Gate with Non-Inverted Inputs
XNOR9	Macro: 9-Input XNOR Gate with Non-Inverted Inputs
XOR2	Primitive: 2-Input XOR Gate with Non-Inverted Inputs
XOR3	Primitive: 3-Input XOR Gate with Non-Inverted Inputs
XOR4	Primitive: 4-Input XOR Gate with Non-Inverted Inputs
XOR5	Primitive: 5-Input XOR Gate with Non-Inverted Inputs
XOR6	Macro: 6-Input XOR Gate with Non-Inverted Inputs
XOR7	Macro: 7-Input XOR Gate with Non-Inverted Inputs
XOR8	Macro: 8-Input XOR Gate with Non-Inverted Inputs
XOR9	Macro: 9-Input XOR Gate with Non-Inverted Inputs

LUT

Design Element	Description
LUT1	Primitive: 1-Bit Look-Up Table with General Output
LUT1_D	Primitive: 1-Bit Look-Up Table with Dual Output
LUT1_L	Primitive: 1-Bit Look-Up Table with Local Output
LUT2	Primitive: 2-Bit Look-Up Table with General Output
LUT2_D	Primitive: 2-Bit Look-Up Table with Dual Output
LUT2_L	Primitive: 2-Bit Look-Up Table with Local Output
LUT3	Primitive: 3-Bit Look-Up Table with General Output
LUT3_D	Primitive: 3-Bit Look-Up Table with Dual Output
LUT3_L	Primitive: 3-Bit Look-Up Table with Local Output
LUT4	Primitive: 4-Bit Look-Up-Table with General Output
LUT4_D	Primitive: 4-Bit Look-Up Table with Dual Output
LUT4_L	Primitive: 4-Bit Look-Up Table with Local Output

Memory

Design Element	Description
RAM16X1D	Primitive: 16-Deep by 1-Wide Static Dual Port Synchronous RAM
RAM16X1D_1	Primitive: 16-Deep by 1-Wide Static Dual Port Synchronous RAM with Negative-Edge Clock
RAM16X1S	Primitive: 16-Deep by 1-Wide Static Synchronous RAM
RAM16X1S_1	Primitive: 16-Deep by 1-Wide Static Synchronous RAM with Negative-Edge Clock
RAM16X2S	Primitive: 16-Deep by 2-Wide Static Synchronous RAM

Design Element	Description
RAM16X4S	Primitive: 16-Deep by 4-Wide Static Synchronous RAM
RAM16X8S	Primitive: 16-Deep by 8-Wide Static Synchronous RAM
RAM32X1S	Primitive: 32-Deep by 1-Wide Static Synchronous RAM
RAM32X1S_1	Primitive: 32-Deep by 1-Wide Static Synchronous RAM with Negative-Edge Clock
RAM32X2S	Primitive: 32-Deep by 2-Wide Static Synchronous RAM
RAM32X4S	Primitive: 32-Deep by 4-Wide Static Synchronous RAM
RAM32X8S	Primitive: 32-Deep by 8-Wide Static Synchronous RAM
RAM64X1S	Primitive: 64-Deep by 1-Wide Static Synchronous RAM
RAM64X1S_1	Primitive: 64-Deep by 1-Wide Static Synchronous RAM with Negative-Edge Clock
RAM64X2S	Primitive: 64-Deep by 2-Wide Static Synchronous RAM
RAMB16_S1	Primitive: 16K-bit Data and 2K-bit Parity Single-Port Synchronous Block RAM with 1-bit Port
RAMB16_S18	Primitive: 16K-bit Data + 2K-bit Parity Memory, Single-Port Synchronous Block RAM with 18-bit Port
RAMB16_S18_S18	Primitive: 16K-bit Data and 2K-bit Parity Dual-Port Synchronous Block RAM with 18-bit Ports
RAMB16_S18_S36	Primitive: 16K-bit Data and 2K-bit Parity Dual-Port Synchronous Block RAM with 18-bit and 36-bit Ports
RAMB16_S1_S1	Primitive: 16K-bit Data and 2K-bit Parity Dual-Port Synchronous Block RAM with 1-bit Ports
RAMB16_S1_S18	Primitive: 16K-bit Data and 2K-bit Parity Dual-Port Synchronous Block RAM with 1-bit and 18-bit Ports
RAMB16_S1_S2	Primitive: 16K-bit Data and 2K-bit Parity Dual-Port Synchronous Block RAM with 1-bit and 2-bit Ports
RAMB16_S1_S36	Primitive: 16K-bit Data and 2K-bit Parity Dual-Port Synchronous Block RAM with 1-bit and 36-bit Ports
RAMB16_S1_S4	Primitive: 16K-bit Data and 2K-bit Parity Dual-Port Synchronous Block RAM with 1-bit and 4-bit Ports
RAMB16_S1_S9	Primitive: 16K-bit Data and 2K-bit Parity Dual-Port Synchronous Block RAM with 1-bit and 9-bit Ports
RAMB16_S2	Primitive: 16K-bit Data and 2K-bit Parity Single-Port Synchronous Block RAM with 2-bit Port
RAMB16_S2_S18	Primitive: 16K-bit Data and 2K-bit Parity Dual-Port Synchronous Block RAM with 2-bit and 18-bit Ports
RAMB16_S2_S2	Primitive: 16K-bit Data and 2K-bit Parity Dual-Port Synchronous Block RAM with 2-bit Ports
RAMB16_S2_S36	Primitive: 16K-bit Data and 2K-bit Parity Dual-Port Synchronous Block RAM with 2-bit and 36-bit Ports
RAMB16_S2_S4	Primitive: 16K-bit Data and 2K-bit Parity Dual-Port Synchronous Block RAM with 2-bit and 4-bit Ports
RAMB16_S2_S9	Primitive: 16K-bit Data and 2K-bit Parity Dual-Port Synchronous Block RAM with 2-bit and 9-bit Ports
RAMB16_S36	Primitive: 16K-bit Data and 2K-bit Parity Single-Port Synchronous Block RAM with 36-bit Port

Design Element	Description
RAMB16_S36_S36	Primitive: 16K-bit Data and 2K-bit Parity Dual-Port Synchronous Block RAM with Two 36-bit Ports
RAMB16_S4	Primitive: 16K-bit Data and 2K-bit Parity Single-Port Synchronous Block RAM with 4-bit Port
RAMB16_S4_S18	Primitive: 16K-bit Data and 2K-bit Parity Dual-Port Synchronous Block RAM with 4-bit and 18-bit Ports
RAMB16_S4_S36	Primitive: 16K-bit Data and 2K-bit Parity Dual-Port Synchronous Block RAM with 4-bit and 36-bit Ports
RAMB16_S4_S4	Primitive: 16K-bit Data and 2K-bit Parity Dual-Port Synchronous Block RAM with 4-bit Ports
RAMB16_S4_S9	Primitive: 16K-bit Data and 2K-bit Parity Dual-Port Synchronous Block RAM with 4-bit and 9-bit Ports
RAMB16_S9	Primitive: 16K-bit Data and 2K-bit Parity Single-Port Synchronous Block RAM with 9-bit Port
RAMB16_S9_S18	Primitive: 16K-bit Data and 2K-bit Parity Dual-Port Synchronous Block RAM with 9-bit and 18-bit Ports
RAMB16_S9_S36	Primitive: 16K-bit Data and 2K-bit Parity Dual-Port Synchronous Block RAM with 9-bit and 36-bit Ports
RAMB16_S9_S9	Primitive: 16K-bit Data and 2K-bit Parity Dual-Port Synchronous Block RAM with 9-bit Ports
ROM16X1	Primitive: 16-Deep by 1-Wide ROM
ROM32X1	Primitive: 32-Deep by 1-Wide ROM
ROM64X1	Primitive: 64-Deep by 1-Wide ROM
ROM128X1	Primitive: 128-Deep by 1-Wide ROM
ROM256X1	Primitive: 256-Deep by 1-Wide ROM

Mux

Design Element	Description
M16_1E	Macro: 16-to-1 Multiplexer with Enable
M2_1	Macro: 2-to-1 Multiplexer
M2_1B1	Macro: 2-to-1 Multiplexer with D0 Inverted
M2_1B2	Macro: 2-to-1 Multiplexer with D0 and D1 Inverted
M2_1E	Macro: 2-to-1 Multiplexer with Enable
M4_1E	Macro: 4-to-1 Multiplexer with Enable
M8_1E	Macro: 8-to-1 Multiplexer with Enable
MUXF5	Primitive: 2-to-1 Look-Up Table Multiplexer with General Output
MUXF5_D	Primitive: 2-to-1 Look-Up Table Multiplexer with Dual Output
MUXF5_L	Primitive: 2-to-1 Look-Up Table Multiplexer with Local Output
MUXF6	Primitive: 2-to-1 Look-Up Table Multiplexer with General Output

Design Element	Description
MUXF6_D	Primitive: 2-to-1 Look-Up Table Multiplexer with Dual Output
MUXF6_L	Primitive: 2-to-1 Look-Up Table Multiplexer with Local Output
MUXF7	Primitive: 2-to-1 Look-Up Table Multiplexer with General Output
MUXF7_D	Primitive: 2-to-1 Look-Up Table Multiplexer with Dual Output
MUXF7_L	Primitive: 2-to-1 look-up table Multiplexer with Local Output
MUXF8	Primitive: 2-to-1 Look-Up Table Multiplexer with General Output
MUXF8_D	Primitive: 2-to-1 Look-Up Table Multiplexer with Dual Output
MUXF8_L	Primitive: 2-to-1 Look-Up Table Multiplexer with Local Output

Shift Register

Design Element	Description
SR16CE	Macro: 16-Bit Serial-In Parallel-Out Shift Register with Clock Enable and Asynchronous Clear
SR16CLE	Macro: 16-Bit Loadable Serial/Parallel-In Parallel-Out Shift Register with Clock Enable and Asynchronous Clear
SR16CLED	Macro: 16-Bit Shift Register with Clock Enable and Asynchronous Clear
SR16RE	Macro: 16-Bit Serial-In Parallel-Out Shift Register with Clock Enable and Synchronous Reset
SR16RLE	Macro: 16-Bit Loadable Serial/Parallel-In Parallel-Out Shift Register with Clock Enable and Synchronous Reset
SR16RLED	Macro: 16-Bit Shift Register with Clock Enable and Synchronous Reset
SR4CE	Macro: 4-Bit Serial-In Parallel-Out Shift Register with Clock Enable and Asynchronous Clear
SR4CLE	Macro: 4-Bit Loadable Serial/Parallel-In Parallel-Out Shift Register with Clock Enable and Asynchronous Clear
SR4CLED	Macro: 4-Bit Shift Register with Clock Enable and Asynchronous Clear
SR4RE	Macro: 4-Bit Serial-In Parallel-Out Shift Register with Clock Enable and Synchronous Reset
SR4RLE	Macro: 4-Bit Loadable Serial/Parallel-In Parallel-Out Shift Register with Clock Enable and Synchronous Reset
SR4RLED	Macro: 4-Bit Shift Register with Clock Enable and Synchronous Reset
SR8CE	Macro: 8-Bit Serial-In Parallel-Out Shift Register with Clock Enable and Asynchronous Clear
SR8CLE	Macro: 8-Bit Loadable Serial/Parallel-In Parallel-Out Shift Register with Clock Enable and Asynchronous Clear

Design Element	Description
SR8CLED	Macro: 8-Bit Shift Register with Clock Enable and Asynchronous Clear
SR8RE	Macro: 8-Bit Serial-In Parallel-Out Shift Register with Clock Enable and Synchronous Reset
SR8RLE	Macro: 8-Bit Loadable Serial/Parallel-In Parallel-Out Shift Register with Clock Enable and Synchronous Reset
SR8RLED	Macro: 8-Bit Shift Register with Clock Enable and Synchronous Reset
SRL16	Primitive: 16-Bit Shift Register Look-Up Table (LUT)
SRL16_1	Primitive: 16-Bit Shift Register Look-Up Table (LUT) with Negative-Edge Clock
SRL16E	Primitive: 16-Bit Shift Register Look-Up Table (LUT) with Clock Enable
SRL16E_1	Primitive: 16-Bit Shift Register Look-Up Table (LUT) with Negative-Edge Clock and Clock Enable
SRLC16	Primitive: 16-Bit Shift Register Look-Up Table (LUT) with Carry
SRLC16_1	Primitive: 16-Bit Shift Register Look-Up Table (LUT) with Carry and Negative-Edge Clock
SRLC16E	Primitive: 16-Bit Shift Register Look-Up Table (LUT) with Carry and Clock Enable
SRLC16E_1	Primitive: 16-Bit Shift Register Look-Up Table (LUT) with Carry, Negative-Edge Clock, and Clock Enable

Shifter

Design Element	Description
BRLSHFT4	Macro: 4-Bit Barrel Shifter
BRLSHFT8	Macro: 8-Bit Barrel Shifter

About Design Elements

This section describes the design elements that can be used with Spartan®-3E devices. The design elements are organized alphabetically.

The following information is provided for each design element, where applicable:

- Name of element
- Brief description
- Schematic symbol (if any)
- Logic Table (if any)
- Port Descriptions (if any)
- Design Entry Method
- Available Attributes (if any)
- For more information

You can find examples of VHDL and Verilog instantiation code in the ISE software (in the main menu, select **Edit > Language Templates** or in the *Libraries Guide for HDL Designs* for this architecture.

ACC16

Macro: 16-Bit Loadable Cascadable Accumulator with Carry-In, Carry-Out, and Synchronous Reset

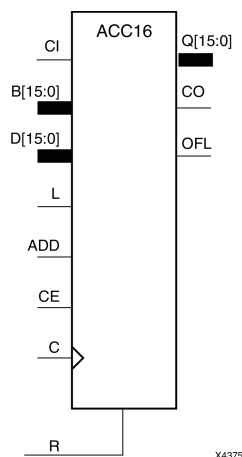

Introduction

This design element can add or subtract a 16-bit unsigned-binary, respectively or two's-complement word to or from the contents of a 16-bit data register and store the results in the register. The register can be loaded with the 16-bit word.

When the load input (L) is High, CE is ignored and the data on the D inputs is loaded into the register during the Low-to-High clock (C) transition. ACC16 loads the data on inputs D15 : D0 into the 16-bit register.

This design element operates on either 16-bit unsigned binary numbers or 16-bit two's-complement numbers. If the inputs are interpreted as unsigned binary, the result can be interpreted as unsigned binary. If the inputs are interpreted as two's complement, the output can be interpreted as two's complement. The only functional difference between an unsigned binary operation and a two's-complement operation is how they determine when "overflow" occurs. Unsigned binary uses carry-out (CO), while two's complement uses OFL to determine when "overflow" occurs.

- For unsigned binary operation, ACC16 can represent numbers between 0 and 15, inclusive. In add mode, CO is active (High) when the sum exceeds the bounds of the adder/subtractor. In subtract mode, CO is an active-Low borrow-out and goes Low when the difference exceeds the bounds. The carry-out (CO) is not registered synchronously with the data outputs. CO always reflects the accumulation of the B inputs (B15 : B0 for ACC16). This allows the cascading of ACC16s by connecting CO of one stage to CI of the next stage. An unsigned binary "overflow" that is always active-High can be generated by gating the ADD signal and CO as follows:

```
unsigned overflow = CO XOR ADD
```

Ignore OFL in unsigned binary operation.

- For two's-complement operation, ACC16 represents numbers between -8 and +7, inclusive. If an addition or subtraction operation result exceeds this range, the OFL output goes High. The overflow (OFL) is not registered synchronously with the data outputs. OFL always reflects the accumulation of the B inputs (B15 : B0 for ACC16) and the contents of the register, which allows cascading of ACC4s by connecting OFL of one stage to CI of the next stage.

Ignore CO in two's-complement operation.

The synchronous reset (R) has priority over all other inputs, and when set to High, causes all outputs to go to logic level zero during the Low-to-High clock (C) transition. Clock (C) transitions are ignored when clock enable (CE) is Low.

This design element is asynchronously cleared, outputs Low, when power is applied. For FPGA devices, power-on conditions are simulated when global set/reset (GSR) is active. GSR defaults to active-High but can be inverted by adding an inverter in front of the GSR input of the appropriate `STARTUP_architecture` symbol.

Logic Table

Input						Output
R	L	CE	ADD	D	C	Q
1	x	x	x	x	↑	0
0	1	x	x	Dn	↑	Dn
0	0	1	1	x	↑	Q0+Bn+CI
0	0	1	0	x	↑	Q0-Bn-CI
0	0	0	x	x	↑	No Change

Q0: Previous value of Q
 Bn: Value of Data input B
 CI: Value of input CI

Design Entry Method

This design element is only for use in schematics.

For More Information

- See the [Spartan-3 Generation FPGA User Guide \(UG331\)](#).
- See the [Spartan-3E FPGA Family Data Sheet \(DS312\)](#).

ACC4

Macro: 4-Bit Loadable Cascadable Accumulator with Carry-In, Carry-Out, and Synchronous Reset

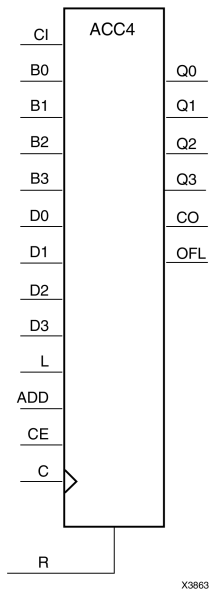

Introduction

This design element can add or subtract a 4-bit unsigned-binary, respectively or two's-complement word to or from the contents of a 4-bit data register and store the results in the register. The register can be loaded with the 4-bit word.

When the load input (L) is High, CE is ignored and the data on the D inputs is loaded into the register during the Low-to-High clock (C) transition. ACC4 loads the data on inputs D3 : D0 into the 4-bit register.

This design element operates on either 4-bit unsigned binary numbers or 4-bit two's-complement numbers. If the inputs are interpreted as unsigned binary, the result can be interpreted as unsigned binary. If the inputs are interpreted as two's complement, the output can be interpreted as two's complement. The only functional difference between an unsigned binary operation and a two's-complement operation is how they determine when "overflow" occurs. Unsigned binary uses carry-out (CO), while two's complement uses OFL to determine when "overflow" occurs.

- For unsigned binary operation, ACC4 can represent numbers between 0 and 15, inclusive. In add mode, CO is active (High) when the sum exceeds the bounds of the adder/subtractor. In subtract mode, CO is an active-Low borrow-out and goes Low when the difference exceeds the bounds. The carry-out (CO) is not registered synchronously with the data outputs. CO always reflects the accumulation of the B inputs (B3 : B0 for ACC4). This allows the cascading of ACC4s by connecting CO of one stage to CI of the next stage. An unsigned binary "overflow" that is always active-High can be generated by gating the ADD signal and CO as follows:

```
unsigned overflow = CO XOR ADD
```

Ignore OFL in unsigned binary operation.

- For two's-complement operation, ACC4 represents numbers between -8 and +7, inclusive. If an addition or subtraction operation result exceeds this range, the OFL output goes High. The overflow (OFL) is not registered synchronously with the data outputs. OFL always reflects the accumulation of the B inputs (B3 : B0 for ACC4) and the contents of the register, which allows cascading of ACC4s by connecting OFL of one stage to CI of the next stage.

Ignore CO in two's-complement operation.

The synchronous reset (R) has priority over all other inputs, and when set to High, causes all outputs to go to logic level zero during the Low-to-High clock (C) transition. Clock (C) transitions are ignored when clock enable (CE) is Low.

This design element is asynchronously cleared, outputs Low, when power is applied. For FPGA devices, power-on conditions are simulated when global set/reset (GSR) is active. GSR defaults to active-High but can be inverted by adding an inverter in front of the GSR input of the appropriate `STARTUP_architecture` symbol.

Logic Table

Input						Output
R	L	CE	ADD	D	C	Q
1	x	x	x	x	↑	0
0	1	x	x	Dn	↑	Dn
0	0	1	1	x	↑	Q0+Bn+CI
0	0	1	0	x	↑	Q0-Bn-CI
0	0	0	x	x	↑	No Change

Q0: Previous value of Q
 Bn: Value of Data input B
 CI: Value of input CI

Design Entry Method

This design element is only for use in schematics.

For More Information

- See the [Spartan-3 Generation FPGA User Guide \(UG331\)](#).
- See the [Spartan-3E FPGA Family Data Sheet \(DS312\)](#).

ACC8

Macro: 8-Bit Loadable Cascadable Accumulator with Carry-In, Carry-Out, and Synchronous Reset

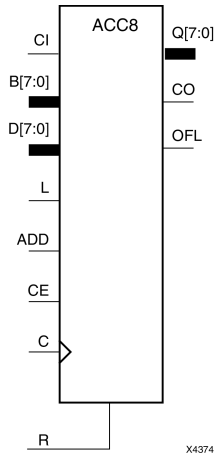

Introduction

This design element can add or subtract a 8-bit unsigned-binary, respectively or two's-complement word to or from the contents of a 8-bit data register and store the results in the register. The register can be loaded with the 8-bit word.

When the load input (L) is High, CE is ignored and the data on the D inputs is loaded into the register during the Low-to-High clock (C) transition. ACC8 loads the data on inputs D7 : D0 into the 8-bit register.

This design element operates on either 8-bit unsigned binary numbers or 8-bit two's-complement numbers. If the inputs are interpreted as unsigned binary, the result can be interpreted as unsigned binary. If the inputs are interpreted as two's complement, the output can be interpreted as two's complement. The only functional difference between an unsigned binary operation and a two's-complement operation is how they determine when "overflow" occurs. Unsigned binary uses carry-out (CO), while two's complement uses OFL to determine when "overflow" occurs.

- For unsigned binary operation, ACC8 can represent numbers between 0 and 255, inclusive. In add mode, CO is active (High) when the sum exceeds the bounds of the adder/subtractor. In subtract mode, CO is an active-Low borrow-out and goes Low when the difference exceeds the bounds. The carry-out (CO) is not registered synchronously with the data outputs. CO always reflects the accumulation of the B inputs (B3 : B0 for ACC4). This allows the cascading of ACC8s by connecting CO of one stage to CI of the next stage. An unsigned binary "overflow" that is always active-High can be generated by gating the ADD signal and CO as follows:

```
unsigned overflow = CO XOR ADD
```

Ignore OFL in unsigned binary operation.

- For two's-complement operation, ACC8 represents numbers between -128 and +127, inclusive. If an addition or subtraction operation result exceeds this range, the OFL output goes High. The overflow (OFL) is not registered synchronously with the data outputs. OFL always reflects the accumulation of the B inputs (B3 : B0 for ACC8) and the contents of the register, which allows cascading of ACC8s by connecting OFL of one stage to CI of the next stage.

Ignore CO in two's-complement operation.

The synchronous reset (R) has priority over all other inputs, and when set to High, causes all outputs to go to logic level zero during the Low-to-High clock (C) transition. Clock (C) transitions are ignored when clock enable (CE) is Low.

This design element is asynchronously cleared, outputs Low, when power is applied. For FPGA devices, power-on conditions are simulated when global set/reset (GSR) is active. GSR defaults to active-High but can be inverted by adding an inverter in front of the GSR input of the appropriate `STARTUP_architecture` symbol.

Logic Table

Input						Output
R	L	CE	ADD	D	C	Q
1	x	x	x	x	↑	0
0	1	x	x	Dn	↑	Dn
0	0	1	1	x	↑	Q0+Bn+CI
0	0	1	0	x	↑	Q0-Bn-CI
0	0	0	x	x	↑	No Change

Q0: Previous value of Q
 Bn: Value of Data input B
 CI: Value of input CI

Design Entry Method

This design element is only for use in schematics.

For More Information

- See the [Spartan-3 Generation FPGA User Guide \(UG331\)](#).
- See the [Spartan-3E FPGA Family Data Sheet \(DS312\)](#).

ADD16

Macro: 16-Bit Cascadable Full Adder with Carry-In, Carry-Out, and Overflow

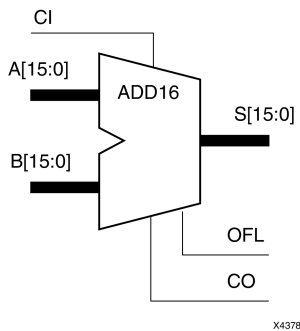

Introduction

This design element adds two words and a carry-in (CI), producing a sum output and carry-out (CO) or overflow (OFL). The factors added are A15:A0, B15:B0 and CI, producing the sum output S15:S0 and CO (or OFL).

Logic Table

Input		Output
A	B	S
A _n	B _n	A _n +B _n +CI
CI: Value of input CI.		

Unsigned Binary Versus Two's Complement -This design element can operate on either 16-bit unsigned binary numbers or 16-bit two's-complement numbers, respectively. If the inputs are interpreted as unsigned binary, the result can be interpreted as unsigned binary. If the inputs are interpreted as two's complement, the output can be interpreted as two's complement. The only functional difference between an unsigned binary operation and a two's-complement operation is the way they determine when "overflow" occurs. Unsigned binary uses CO, while two's-complement uses OFL to determine when "overflow" occurs. To interpret the inputs as unsigned binary, follow the CO output. To interpret the inputs as two's complement, follow the OFL output.

Unsigned Binary Operation -For unsigned binary operation, this element represents numbers between 0 and 65535, inclusive. OFL is ignored in unsigned binary operation.

Two's-Complement Operation -For two's-complement operation, this element can represent numbers between -32768 and +32767, inclusive. OFL is active (High) when the sum exceeds the bounds of the adder. CO is ignored in two's-complement operation.

Design Entry Method

This design element is only for use in schematics.

For More Information

- See the [Spartan-3 Generation FPGA User Guide \(UG331\)](#).
- See the [Spartan-3E FPGA Family Data Sheet \(DS312\)](#).

ADD4

Macro: 4-Bit Cascadable Full Adder with Carry-In, Carry-Out, and Overflow

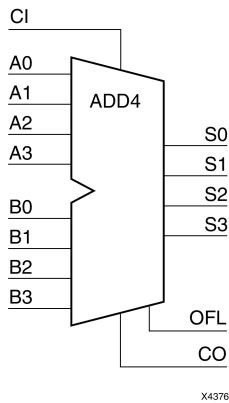

Introduction

This design element adds two words and a carry-in (CI), producing a sum output and carry-out (CO) or overflow (OFL). The factors added are A3:A0, B3:B0, and CI producing the sum output S3:S0 and CO (or OFL).

Logic Table

Input		Output
A	B	S
A _n	B _n	A _n +B _n +CI
CI: Value of input CI.		

Unsigned Binary Versus Two's Complement -This design element can operate on either 4-bit unsigned binary numbers or 4-bit two's-complement numbers, respectively. If the inputs are interpreted as unsigned binary, the result can be interpreted as unsigned binary. If the inputs are interpreted as two's complement, the output can be interpreted as two's complement. The only functional difference between an unsigned binary operation and a two's-complement operation is the way they determine when "overflow" occurs. Unsigned binary uses CO, while two's-complement uses OFL to determine when "overflow" occurs. To interpret the inputs as unsigned binary, follow the CO output. To interpret the inputs as two's complement, follow the OFL output.

Unsigned Binary Operation -For unsigned binary operation, this element represents numbers from 0 to 15, inclusive. OFL is ignored in unsigned binary operation.

Two's-Complement Operation -For two's-complement operation, this element can represent numbers between -8 and +7, inclusive. OFL is active (High) when the sum exceeds the bounds of the adder. CO is ignored in two's-complement operation.

Design Entry Method

This design element is only for use in schematics.

For More Information

- See the [Spartan-3 Generation FPGA User Guide \(UG331\)](#).
- See the [Spartan-3E FPGA Family Data Sheet \(DS312\)](#).

ADD8

Macro: 8-Bit Cascadable Full Adder with Carry-In, Carry-Out, and Overflow

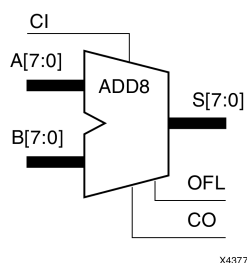

Introduction

This design element adds two words and a carry-in (CI), producing a sum output and carry-out (CO) or overflow (OFL). The factors added are A7:A0, B7:B0, and CI, producing the sum output S7:S0 and CO (or OFL).

Logic Table

Input		Output
A	B	S
A _n	B _n	A _n +B _n +CI
CI: Value of input CI.		

Unsigned Binary Versus Two's Complement -This design element can operate on either 8-bit unsigned binary numbers or 8-bit two's-complement numbers, respectively. If the inputs are interpreted as unsigned binary, the result can be interpreted as unsigned binary. If the inputs are interpreted as two's complement, the output can be interpreted as two's complement. The only functional difference between an unsigned binary operation and a two's-complement operation is the way they determine when "overflow" occurs. Unsigned binary uses CO, while two's-complement uses OFL to determine when "overflow" occurs. To interpret the inputs as unsigned binary, follow the CO output. To interpret the inputs as two's complement, follow the OFL output.

Unsigned Binary Operation -For unsigned binary operation, this element represents numbers between 0 and 255, inclusive. OFL is ignored in unsigned binary operation.

Two's-Complement Operation -For two's-complement operation, this element can represent numbers between -128 and +127, inclusive. OFL is active (High) when the sum exceeds the bounds of the adder. CO is ignored in two's-complement operation.

Design Entry Method

This design element is only for use in schematics.

For More Information

- See the [Spartan-3 Generation FPGA User Guide \(UG331\)](#).
- See the [Spartan-3E FPGA Family Data Sheet \(DS312\)](#).

ADSU16

Macro: 16-Bit Cascadable Adder/Subtractor with Carry-In, Carry-Out, and Overflow

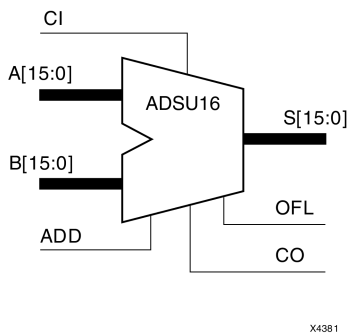

Introduction

When the ADD input is High, this element adds two 16-bit words (A15:A0 and B15:B0) and a carry-in (CI), producing a 16-bit sum output (S15:S0) and carry-out (CO) or overflow (OFL).

When the ADD input is Low, this element subtracts B15:B0 from A15:A0, producing a difference output and a carry-out (CO) or an overflow (OFL).

In add mode, CO and CI are active-High. In subtract mode, CO and CI are active-Low. OFL is active-High in add and subtract modes.

Logic Table

Input			Output
ADD	A	B	S
1	A _n	B _n	A _n +B _n +CI*
0	A _n	B _n	A _n -B _n -CI*
CI*: ADD = 0, CI, CO active LOW			
CI*: ADD = 1, CI, CO active HIGH			

Unsigned Binary Versus Two's Complement -This design element can operate on either 16-bit unsigned binary numbers or 16-bit two's-complement numbers. If the inputs are interpreted as unsigned binary, the result can be interpreted as unsigned binary. If the inputs are interpreted as two's complement, the output can be interpreted as two's complement. The only functional difference between an unsigned binary operation and a two's-complement operation is the way they determine when "overflow" occurs. Unsigned binary uses CO, while two's complement uses OFL to determine when "overflow" occurs.

With adder/subtractors, either unsigned binary or two's-complement operations cause an overflow. If the result crosses the overflow boundary, an overflow is generated. Similarly, when the result crosses the carry-out boundary, a carry-out is generated.

Unsigned Binary Operation -For unsigned binary operation, this element can represent numbers between 0 and 65535, inclusive. In add mode, CO is active (High) when the sum exceeds the bounds of the adder/subtractor. In subtract mode, CO is an active-Low borrow-out and goes Low when the difference exceeds the bounds.

An unsigned binary "overflow" that is always active-High can be generated by gating the ADD signal and CO as follows:

$$\text{unsigned overflow} = \text{CO XOR ADD}$$

OFL is ignored in unsigned binary operation.

Two's-Complement Operation -For two's-complement operation, this element can represent numbers between -32768 and +32767, inclusive.

If an addition or subtraction operation result exceeds this range, the OFL output goes High. CO is ignored in two's-complement operation.

Design Entry Method

This design element is only for use in schematics.

For More Information

- See the [Spartan-3 Generation FPGA User Guide \(UG331\)](#).
- See the [Spartan-3E FPGA Family Data Sheet \(DS312\)](#).

ADSU4

Macro: 4-Bit Cascadable Adder/Subtractor with Carry-In, Carry-Out, and Overflow

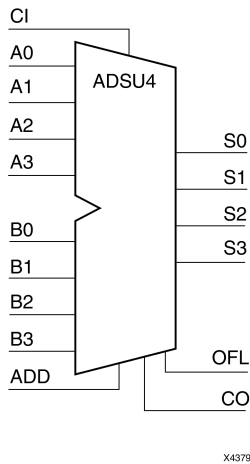

Introduction

When the ADD input is High, this element adds two 4-bit words (A3:A0 and B3:B0) and a carry-in (CI), producing a 4-bit sum output (S3:S0) and a carry-out (CO) or an overflow (OFL).

When the ADD input is Low, this element subtracts B3:B0 from A3:A0, producing a 4-bit difference output (S3:S0) and a carry-out (CO) or an overflow (OFL).

In add mode, CO and CI are active-High. In subtract mode, CO and CI are active-Low. OFL is active-High in add and subtract modes.

Logic Table

Input			Output
ADD	A	B	S
1	A _n	B _n	A _n +B _n +CI*
0	A _n	B _n	A _n -B _n -CI*

CI*: ADD = 0, CI, CO active LOW
 CI*: ADD = 1, CI, CO active HIGH

Unsigned Binary Versus Two's Complement -This design element can operate on either 4-bit unsigned binary numbers or 4-bit two's-complement numbers. If the inputs are interpreted as unsigned binary, the result can be interpreted as unsigned binary. If the inputs are interpreted as two's complement, the output can be interpreted as two's complement. The only functional difference between an unsigned binary operation and a two's-complement operation is the way they determine when "overflow" occurs. Unsigned binary uses CO, while two's complement uses OFL to determine when "overflow" occurs.

With adder/subtractors, either unsigned binary or two's-complement operations cause an overflow. If the result crosses the overflow boundary, an overflow is generated. Similarly, when the result crosses the carry-out boundary, a carry-out is generated.

Unsigned Binary Operation -For unsigned binary operation, ADSU4 can represent numbers between 0 and 15, inclusive. In add mode, CO is active (High) when the sum exceeds the bounds of the adder/subtractor. In subtract mode, CO is an active-Low borrow-out and goes Low when the difference exceeds the bounds.

An unsigned binary "overflow" that is always active-High can be generated by gating the ADD signal and CO as follows:

unsigned overflow = CO XOR ADD

OFL is ignored in unsigned binary operation.

Two's-Complement Operation -For two's-complement operation, this element can represent numbers between -8 and +7, inclusive.

If an addition or subtraction operation result exceeds this range, the OFL output goes High. CO is ignored in two's-complement operation.

Design Entry Method

This design element is only for use in schematics.

For More Information

- See the [Spartan-3 Generation FPGA User Guide \(UG331\)](#).
- See the [Spartan-3E FPGA Family Data Sheet \(DS312\)](#).

ADSU8

Macro: 8-Bit Cascadable Adder/Subtractor with Carry-In, Carry-Out, and Overflow

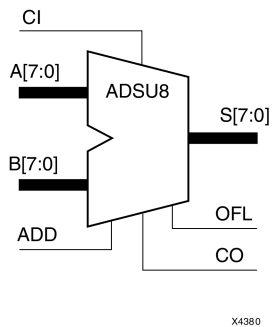

Introduction

When the ADD input is High, this element adds two 8-bit words (A7:A0 and B7:B0) and a carry-in (CI), producing an 8-bit sum output (S7:S0) and carry-out (CO) or an overflow (OFL).

When the ADD input is Low, this element subtracts B7:B0 from A7:A0, producing an 8-bit difference output (S7:S0) and a carry-out (CO) or an overflow (OFL).

In add mode, CO and CI are active-High. In subtract mode, CO and CI are active-Low. OFL is active-High in add and subtract modes.

Logic Table

Input			Output
ADD	A	B	S
1	A _n	B _n	A _n +B _n +CI*
0	A _n	B _n	A _n -B _n -CI*
CI*: ADD = 0, CI, CO active LOW			
CI*: ADD = 1, CI, CO active HIGH			

Unsigned Binary Versus Two's Complement -This design element can operate on either 8-bit unsigned binary numbers or 8-bit two's-complement numbers. If the inputs are interpreted as unsigned binary, the result can be interpreted as unsigned binary. If the inputs are interpreted as two's complement, the output can be interpreted as two's complement. The only functional difference between an unsigned binary operation and a two's-complement operation is the way they determine when "overflow" occurs. Unsigned binary uses CO, while two's complement uses OFL to determine when "overflow" occurs.

With adder/subtractors, either unsigned binary or two's-complement operations cause an overflow. If the result crosses the overflow boundary, an overflow is generated. Similarly, when the result crosses the carry-out boundary, a carry-out is generated.

Unsigned Binary Operation -For unsigned binary operation, this element can represent numbers between 0 and 255, inclusive. In add mode, CO is active (High) when the sum exceeds the bounds of the adder/subtractor. In subtract mode, CO is an active-Low borrow-out and goes Low when the difference exceeds the bounds.

An unsigned binary "overflow" that is always active-High can be generated by gating the ADD signal and CO as follows:

$$\text{unsigned overflow} = \text{CO XOR ADD}$$

OFL is ignored in unsigned binary operation.

Two's-Complement Operation -For two's-complement operation, this element can represent numbers between -128 and +127, inclusive.

If an addition or subtraction operation result exceeds this range, the OFL output goes High. CO is ignored in two's-complement operation.

Design Entry Method

This design element is only for use in schematics.

For More Information

- See the [Spartan-3 Generation FPGA User Guide \(UG331\)](#).
- See the [Spartan-3E FPGA Family Data Sheet \(DS312\)](#).

AND12

Macro: 12- Input AND Gate with Non-Inverted Inputs

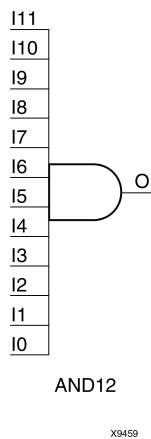

Introduction

AND elements implement logical conjunction. A High output (1) results only if all inputs are High (1). A Low (0) output results if any inputs are Low (0).

AND functions of up to five inputs are available in any combination of inverting and non-inverting inputs. AND functions of six to nine inputs, 12 inputs, and 16 inputs are available with noninverting inputs. To make some or all inputs inverting, use external inverters. Because each input uses a CLB resource, replace functions with unused inputs with functions having the appropriate number of inputs.

Logic Table

Input	Output
I0 ... Iz	O
All inputs are 1	1
Any single input is 0	0

Design Entry Method

This design element is only for use in schematics.

For More Information

- See the [Spartan-3 Generation FPGA User Guide \(UG331\)](#).
- See the [Spartan-3E FPGA Family Data Sheet \(DS312\)](#).

AND16

Macro: 16- Input AND Gate with Non-Inverted Inputs

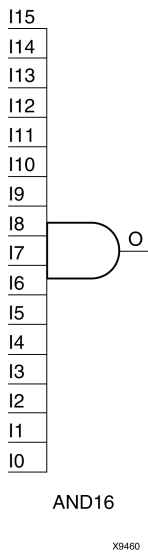

Introduction

AND elements implement logical conjunction. A High output (1) results only if all inputs are High (1). A Low (0) output results if any inputs are Low (0).

AND functions of up to five inputs are available in any combination of inverting and non-inverting inputs. AND functions of six to nine inputs, 12 inputs, and 16 inputs are available with noninverting inputs. To make some or all inputs inverting, use external inverters. Because each input uses a CLB resource, replace functions with unused inputs with functions having the appropriate number of inputs.

Logic Table

Input	Output
I0 ... Iz	O
All inputs are 1	1
Any single input is 0	0

Design Entry Method

This design element is only for use in schematics.

For More Information

- See the [Spartan-3 Generation FPGA User Guide \(UG331\)](#).
- See the [Spartan-3E FPGA Family Data Sheet \(DS312\)](#).

AND2

Primitive: 2-Input AND Gate with Non-Inverted Inputs

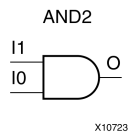

Introduction

AND elements implement logical conjunction. A High output (1) results only if all inputs are High (1). A Low (0) output results if any inputs are Low (0).

AND functions of up to five inputs are available in any combination of inverting and non-inverting inputs. AND functions of six to nine inputs, 12 inputs, and 16 inputs are available with noninverting inputs. To make some or all inputs inverting, use external inverters. Because each input uses a CLB resource, replace functions with unused inputs with functions having the appropriate number of inputs.

Logic Table

Input	Output
I0 ... Iz	0
All inputs are 1	1
Any single input is 0	0

Design Entry Method

This design element is only for use in schematics.

For More Information

- See the [Spartan-3 Generation FPGA User Guide \(UG331\)](#).
- See the [Spartan-3E FPGA Family Data Sheet \(DS312\)](#).

AND2B1

Primitive: 2-Input AND Gate with 1 Inverted and 1 Non-Inverted Inputs

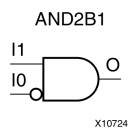

Introduction

AND elements implement logical conjunction. A High output (1) results only if all inputs are High (1). A Low (0) output results if any inputs are Low (0).

AND functions of up to five inputs are available in any combination of inverting and non-inverting inputs. AND functions of six to nine inputs, 12 inputs, and 16 inputs are available with noninverting inputs. To make some or all inputs inverting, use external inverters. Because each input uses a CLB resource, replace functions with unused inputs with functions having the appropriate number of inputs.

Design Entry Method

This design element is only for use in schematics.

For More Information

- See the [Spartan-3 Generation FPGA User Guide \(UG331\)](#).
- See the [Spartan-3E FPGA Family Data Sheet \(DS312\)](#).

AND2B2

Primitive: 2-Input AND Gate with Inverted Inputs

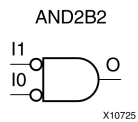

Introduction

AND elements implement logical conjunction. A High output (1) results only if all inputs are High (1). A Low (0) output results if any inputs are Low (0).

AND functions of up to five inputs are available in any combination of inverting and non-inverting inputs. AND functions of six to nine inputs, 12 inputs, and 16 inputs are available with noninverting inputs. To make some or all inputs inverting, use external inverters. Because each input uses a CLB resource, replace functions with unused inputs with functions having the appropriate number of inputs.

Design Entry Method

This design element is only for use in schematics.

For More Information

- See the [Spartan-3 Generation FPGA User Guide \(UG331\)](#).
- See the [Spartan-3E FPGA Family Data Sheet \(DS312\)](#).

AND3

Primitive: 3-Input AND Gate with Non-Inverted Inputs

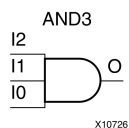

Introduction

AND elements implement logical conjunction. A High output (1) results only if all inputs are High (1). A Low (0) output results if any inputs are Low (0).

AND functions of up to five inputs are available in any combination of inverting and non-inverting inputs. AND functions of six to nine inputs, 12 inputs, and 16 inputs are available with noninverting inputs. To make some or all inputs inverting, use external inverters. Because each input uses a CLB resource, replace functions with unused inputs with functions having the appropriate number of inputs.

Logic Table

Input	Output
I0 ... Iz	0
All inputs are 1	1
Any single input is 0	0

Design Entry Method

This design element is only for use in schematics.

For More Information

- See the [Spartan-3 Generation FPGA User Guide \(UG331\)](#).
- See the [Spartan-3E FPGA Family Data Sheet \(DS312\)](#).

AND3B1

Primitive: 3-Input AND Gate with 1 Inverted and 2 Non-Inverted Inputs

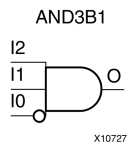

Introduction

AND elements implement logical conjunction. A High output (1) results only if all inputs are High (1). A Low (0) output results if any inputs are Low (0).

AND functions of up to five inputs are available in any combination of inverting and non-inverting inputs. AND functions of six to nine inputs, 12 inputs, and 16 inputs are available with noninverting inputs. To make some or all inputs inverting, use external inverters. Because each input uses a CLB resource, replace functions with unused inputs with functions having the appropriate number of inputs.

Design Entry Method

This design element is only for use in schematics.

For More Information

- See the [Spartan-3 Generation FPGA User Guide \(UG331\)](#).
- See the [Spartan-3E FPGA Family Data Sheet \(DS312\)](#).

AND3B2

Primitive: 3-Input AND Gate with 2 Inverted and 1 Non-Inverted Inputs

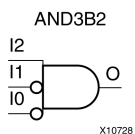

Introduction

AND elements implement logical conjunction. A High output (1) results only if all inputs are High (1). A Low (0) output results if any inputs are Low (0).

AND functions of up to five inputs are available in any combination of inverting and non-inverting inputs. AND functions of six to nine inputs, 12 inputs, and 16 inputs are available with noninverting inputs. To make some or all inputs inverting, use external inverters. Because each input uses a CLB resource, replace functions with unused inputs with functions having the appropriate number of inputs.

Design Entry Method

This design element is only for use in schematics.

For More Information

- See the [Spartan-3 Generation FPGA User Guide \(UG331\)](#).
- See the [Spartan-3E FPGA Family Data Sheet \(DS312\)](#).

AND3B3

Primitive: 3-Input AND Gate with Inverted Inputs

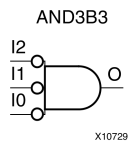

Introduction

AND elements implement logical conjunction. A High output (1) results only if all inputs are High (1). A Low (0) output results if any inputs are Low (0).

AND functions of up to five inputs are available in any combination of inverting and non-inverting inputs. AND functions of six to nine inputs, 12 inputs, and 16 inputs are available with noninverting inputs. To make some or all inputs inverting, use external inverters. Because each input uses a CLB resource, replace functions with unused inputs with functions having the appropriate number of inputs.

Design Entry Method

This design element is only for use in schematics.

For More Information

- See the [Spartan-3 Generation FPGA User Guide \(UG331\)](#).
- See the [Spartan-3E FPGA Family Data Sheet \(DS312\)](#).

AND4

Primitive: 4-Input AND Gate with Non-Inverted Inputs

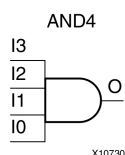

Introduction

AND elements implement logical conjunction. A High output (1) results only if all inputs are High (1). A Low (0) output results if any inputs are Low (0).

AND functions of up to five inputs are available in any combination of inverting and non-inverting inputs. AND functions of six to nine inputs, 12 inputs, and 16 inputs are available with noninverting inputs. To make some or all inputs inverting, use external inverters. Because each input uses a CLB resource, replace functions with unused inputs with functions having the appropriate number of inputs.

Logic Table

Input	Output
I0 ... Iz	0
All inputs are 1	1
Any single input is 0	0

Design Entry Method

This design element is only for use in schematics.

For More Information

- See the [Spartan-3 Generation FPGA User Guide \(UG331\)](#).
- See the [Spartan-3E FPGA Family Data Sheet \(DS312\)](#).

AND4B1

Primitive: 4-Input AND Gate with 1 Inverted and 3 Non-Inverted Inputs

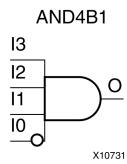

Introduction

AND elements implement logical conjunction. A High output (1) results only if all inputs are High (1). A Low (0) output results if any inputs are Low (0).

AND functions of up to five inputs are available in any combination of inverting and non-inverting inputs. AND functions of six to nine inputs, 12 inputs, and 16 inputs are available with noninverting inputs. To make some or all inputs inverting, use external inverters. Because each input uses a CLB resource, replace functions with unused inputs with functions having the appropriate number of inputs.

Design Entry Method

This design element is only for use in schematics.

For More Information

- See the [Spartan-3 Generation FPGA User Guide \(UG331\)](#).
- See the [Spartan-3E FPGA Family Data Sheet \(DS312\)](#).

AND4B2

Primitive: 4-Input AND Gate with 2 Inverted and 2 Non-Inverted Inputs

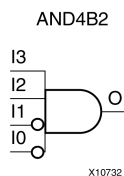

Introduction

AND elements implement logical conjunction. A High output (1) results only if all inputs are High (1). A Low (0) output results if any inputs are Low (0).

AND functions of up to five inputs are available in any combination of inverting and non-inverting inputs. AND functions of six to nine inputs, 12 inputs, and 16 inputs are available with noninverting inputs. To make some or all inputs inverting, use external inverters. Because each input uses a CLB resource, replace functions with unused inputs with functions having the appropriate number of inputs.

Design Entry Method

This design element is only for use in schematics.

For More Information

- See the [Spartan-3 Generation FPGA User Guide \(UG331\)](#).
- See the [Spartan-3E FPGA Family Data Sheet \(DS312\)](#).

AND4B3

Primitive: 4-Input AND Gate with 3 Inverted and 1 Non-Inverted Inputs

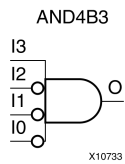

Introduction

AND elements implement logical conjunction. A High output (1) results only if all inputs are High (1). A Low (0) output results if any inputs are Low (0).

AND functions of up to five inputs are available in any combination of inverting and non-inverting inputs. AND functions of six to nine inputs, 12 inputs, and 16 inputs are available with noninverting inputs. To make some or all inputs inverting, use external inverters. Because each input uses a CLB resource, replace functions with unused inputs with functions having the appropriate number of inputs.

Design Entry Method

This design element is only for use in schematics.

For More Information

- See the [Spartan-3 Generation FPGA User Guide \(UG331\)](#).
- See the [Spartan-3E FPGA Family Data Sheet \(DS312\)](#).

AND4B4

Primitive: 4-Input AND Gate with Inverted Inputs

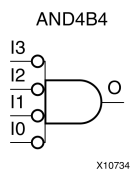

Introduction

AND elements implement logical conjunction. A High output (1) results only if all inputs are High (1). A Low (0) output results if any inputs are Low (0).

AND functions of up to five inputs are available in any combination of inverting and non-inverting inputs. AND functions of six to nine inputs, 12 inputs, and 16 inputs are available with noninverting inputs. To make some or all inputs inverting, use external inverters. Because each input uses a CLB resource, replace functions with unused inputs with functions having the appropriate number of inputs.

Design Entry Method

This design element is only for use in schematics.

For More Information

- See the [Spartan-3 Generation FPGA User Guide \(UG331\)](#).
- See the [Spartan-3E FPGA Family Data Sheet \(DS312\)](#).

AND5

Primitive: 5-Input AND Gate with Non-Inverted Inputs

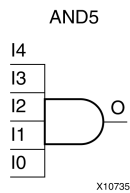

Introduction

AND elements implement logical conjunction. A High output (1) results only if all inputs are High (1). A Low (0) output results if any inputs are Low (0).

AND functions of up to five inputs are available in any combination of inverting and non-inverting inputs. AND functions of six to nine inputs, 12 inputs, and 16 inputs are available with noninverting inputs. To make some or all inputs inverting, use external inverters. Because each input uses a CLB resource, replace functions with unused inputs with functions having the appropriate number of inputs.

Logic Table

Input	Output
I0 ... Iz	0
All inputs are 1	1
Any single input is 0	0

Design Entry Method

This design element is only for use in schematics.

For More Information

- See the [Spartan-3 Generation FPGA User Guide \(UG331\)](#).
- See the [Spartan-3E FPGA Family Data Sheet \(DS312\)](#).

AND5B1

Primitive: 5-Input AND Gate with 1 Inverted and 4 Non-Inverted Inputs

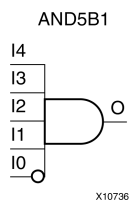

Introduction

AND elements implement logical conjunction. A High output (1) results only if all inputs are High (1). A Low (0) output results if any inputs are Low (0).

AND functions of up to five inputs are available in any combination of inverting and non-inverting inputs. AND functions of six to nine inputs, 12 inputs, and 16 inputs are available with noninverting inputs. To make some or all inputs inverting, use external inverters. Because each input uses a CLB resource, replace functions with unused inputs with functions having the appropriate number of inputs.

Design Entry Method

This design element is only for use in schematics.

For More Information

- See the [Spartan-3 Generation FPGA User Guide \(UG331\)](#).
- See the [Spartan-3E FPGA Family Data Sheet \(DS312\)](#).

AND5B2

Primitive: 5-Input AND Gate with 2 Inverted and 3 Non-Inverted Inputs

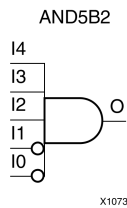

Introduction

AND elements implement logical conjunction. A High output (1) results only if all inputs are High (1). A Low (0) output results if any inputs are Low (0).

AND functions of up to five inputs are available in any combination of inverting and non-inverting inputs. AND functions of six to nine inputs, 12 inputs, and 16 inputs are available with noninverting inputs. To make some or all inputs inverting, use external inverters. Because each input uses a CLB resource, replace functions with unused inputs with functions having the appropriate number of inputs.

Design Entry Method

This design element is only for use in schematics.

For More Information

- See the [Spartan-3 Generation FPGA User Guide \(UG331\)](#).
- See the [Spartan-3E FPGA Family Data Sheet \(DS312\)](#).

AND5B3

Primitive: 5-Input AND Gate with 3 Inverted and 2 Non-Inverted Inputs

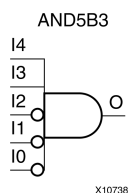

Introduction

AND elements implement logical conjunction. A High output (1) results only if all inputs are High (1). A Low (0) output results if any inputs are Low (0).

AND functions of up to five inputs are available in any combination of inverting and non-inverting inputs. AND functions of six to nine inputs, 12 inputs, and 16 inputs are available with noninverting inputs. To make some or all inputs inverting, use external inverters. Because each input uses a CLB resource, replace functions with unused inputs with functions having the appropriate number of inputs.

Design Entry Method

This design element is only for use in schematics.

For More Information

- See the [Spartan-3 Generation FPGA User Guide \(UG331\)](#).
- See the [Spartan-3E FPGA Family Data Sheet \(DS312\)](#).

AND5B4

Primitive: 5-Input AND Gate with 4 Inverted and 1 Non-Inverted Inputs

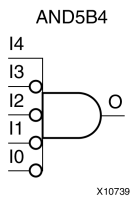

Introduction

AND elements implement logical conjunction. A High output (1) results only if all inputs are High (1). A Low (0) output results if any inputs are Low (0).

AND functions of up to five inputs are available in any combination of inverting and non-inverting inputs. AND functions of six to nine inputs, 12 inputs, and 16 inputs are available with noninverting inputs. To make some or all inputs inverting, use external inverters. Because each input uses a CLB resource, replace functions with unused inputs with functions having the appropriate number of inputs.

Design Entry Method

This design element is only for use in schematics.

For More Information

- See the [Spartan-3 Generation FPGA User Guide \(UG331\)](#).
- See the [Spartan-3E FPGA Family Data Sheet \(DS312\)](#).

AND5B5

Primitive: 5-Input AND Gate with Inverted Inputs

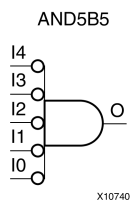

Introduction

AND elements implement logical conjunction. A High output (1) results only if all inputs are High (1). A Low (0) output results if any inputs are Low (0).

AND functions of up to five inputs are available in any combination of inverting and non-inverting inputs. AND functions of six to nine inputs, 12 inputs, and 16 inputs are available with noninverting inputs. To make some or all inputs inverting, use external inverters. Because each input uses a CLB resource, replace functions with unused inputs with functions having the appropriate number of inputs.

Design Entry Method

This design element is only for use in schematics.

For More Information

- See the [Spartan-3 Generation FPGA User Guide \(UG331\)](#).
- See the [Spartan-3E FPGA Family Data Sheet \(DS312\)](#).

AND6

Macro: 6-Input AND Gate with Non-Inverted Inputs

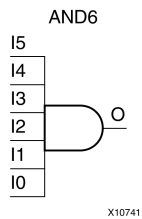

Introduction

AND elements implement logical conjunction. A High output (1) results only if all inputs are High (1). A Low (0) output results if any inputs are Low (0).

AND functions of up to five inputs are available in any combination of inverting and non-inverting inputs. AND functions of six to nine inputs, 12 inputs, and 16 inputs are available with noninverting inputs. To make some or all inputs inverting, use external inverters. Because each input uses a CLB resource, replace functions with unused inputs with functions having the appropriate number of inputs.

Logic Table

Input	Output
I0 ... Iz	O
All inputs are 1	1
Any single input is 0	0

Design Entry Method

This design element is only for use in schematics.

For More Information

- See the [Spartan-3 Generation FPGA User Guide \(UG331\)](#).
- See the [Spartan-3E FPGA Family Data Sheet \(DS312\)](#).

AND7

Macro: 7-Input AND Gate with Non-Inverted Inputs

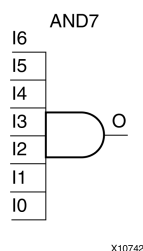

Introduction

AND elements implement logical conjunction. A High output (1) results only if all inputs are High (1). A Low (0) output results if any inputs are Low (0).

AND functions of up to five inputs are available in any combination of inverting and non-inverting inputs. AND functions of six to nine inputs, 12 inputs, and 16 inputs are available with noninverting inputs. To make some or all inputs inverting, use external inverters. Because each input uses a CLB resource, replace functions with unused inputs with functions having the appropriate number of inputs.

Logic Table

Input	Output
I0 ... Iz	O
All inputs are 1	1
Any single input is 0	0

Design Entry Method

This design element is only for use in schematics.

For More Information

- See the [Spartan-3 Generation FPGA User Guide \(UG331\)](#).
- See the [Spartan-3E FPGA Family Data Sheet \(DS312\)](#).

AND8

Macro: 8-Input AND Gate with Non-Inverted Inputs

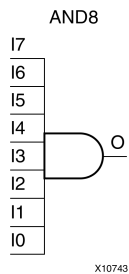

Introduction

AND elements implement logical conjunction. A High output (1) results only if all inputs are High (1). A Low (0) output results if any inputs are Low (0).

AND functions of up to five inputs are available in any combination of inverting and non-inverting inputs. AND functions of six to nine inputs, 12 inputs, and 16 inputs are available with noninverting inputs. To make some or all inputs inverting, use external inverters. Because each input uses a CLB resource, replace functions with unused inputs with functions having the appropriate number of inputs.

Logic Table

Input	Output
I0 ... Iz	O
All inputs are 1	1
Any single input is 0	0

Design Entry Method

This design element is only for use in schematics.

For More Information

- See the [Spartan-3 Generation FPGA User Guide \(UG331\)](#).
- See the [Spartan-3E FPGA Family Data Sheet \(DS312\)](#).

AND9

Macro: 9-Input AND Gate with Non-Inverted Inputs

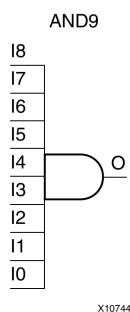

Introduction

AND elements implement logical conjunction. A High output (1) results only if all inputs are High (1). A Low (0) output results if any inputs are Low (0).

AND functions of up to five inputs are available in any combination of inverting and non-inverting inputs. AND functions of six to nine inputs, 12 inputs, and 16 inputs are available with noninverting inputs. To make some or all inputs inverting, use external inverters. Because each input uses a CLB resource, replace functions with unused inputs with functions having the appropriate number of inputs.

Logic Table

Input	Output
I0 ... Iz	0
All inputs are 1	1
Any single input is 0	0

Design Entry Method

This design element is only for use in schematics.

For More Information

- See the [Spartan-3 Generation FPGA User Guide \(UG331\)](#).
- See the [Spartan-3E FPGA Family Data Sheet \(DS312\)](#).

BRLSHFT4

Macro: 4-Bit Barrel Shifter

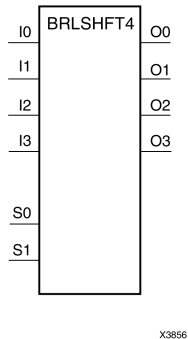

Introduction

This design element is a 4-bit barrel shifter that can rotate four inputs (I3 : I0) up to four places. The control inputs (S1 and S0) determine the number of positions, from one to four, that the data is rotated. The four outputs (O3 : O0) reflect the shifted data inputs.

Logic Table

Inputs						Outputs			
S1	S0	I0	I1	I2	I3	O0	O1	O2	O3
0	0	a	b	c	d	a	b	c	d
0	1	a	b	c	d	b	c	d	a
1	0	a	b	c	d	c	d	a	b
1	1	a	b	c	d	d	a	b	c

Design Entry Method

This design element is only for use in schematics.

For More Information

- See the [Spartan-3 Generation FPGA User Guide \(UG331\)](#).
- See the [Spartan-3E FPGA Family Data Sheet \(DS312\)](#).

BRLSHFT8

Macro: 8-Bit Barrel Shifter

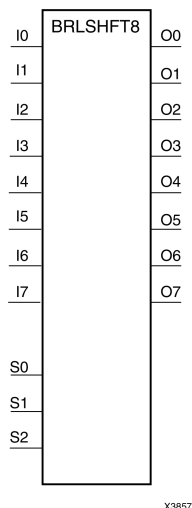

Introduction

This design element is an 8-bit barrel shifter, can rotate the eight inputs (I7 : I0) up to eight places. The control inputs (S2 : S0) determine the number of positions, from one to eight, that the data is rotated. The eight outputs (O7 : O0) reflect the shifted data inputs.

Logic Table

Inputs											Outputs							
S2	S1	S0	I0	I1	I2	I3	I4	I5	I6	I7	O0	O1	O2	O3	O4	O5	O6	O7
0	0	0	a	b	c	d	e	f	g	h	a	b	c	d	e	f	g	h
0	0	1	a	b	c	d	e	f	g	h	b	c	d	e	f	g	h	a
0	1	0	a	b	c	d	e	f	g	h	c	d	e	f	g	h	a	b
0	1	1	a	b	c	d	e	f	g	h	d	e	f	g	h	a	b	c
1	0	0	a	b	c	d	e	f	g	h	e	f	g	h	a	b	c	d
1	0	1	a	b	c	d	e	f	g	h	f	g	h	a	b	c	d	e
1	1	0	a	b	c	d	e	f	g	h	g	h	a	b	c	d	e	f
1	1	1	a	b	c	d	e	f	g	h	h	a	b	c	d	e	f	g

Design Entry Method

This design element is only for use in schematics.

For More Information

- See the [Spartan-3 Generation FPGA User Guide \(UG331\)](#).
- See the [Spartan-3E FPGA Family Data Sheet \(DS312\)](#).

BSCAN_SPARTAN3

Primitive: Spartan®-3 and Spartan-3E JTAG Boundary Scan Logic Access Circuit

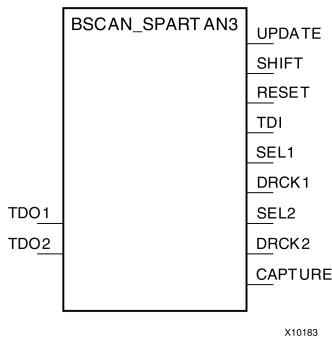

Introduction

This design element allows access to and from internal logic by the JTAG Boundary Scan logic controller. This allows for communication between the internal running design and the dedicated JTAG pins of the FPGA.

Note For specific information on boundary scan for an architecture, see the Programmable Logic Data Sheet for this element.

Port Descriptions

Port	Direction	Width	Function
TDI	Output	1	A mirror of the TDI input pin to the FPGA.
DRCK1, DRK2	Output	1	A mirror of the TCK input pin to the FPGA when the JTAG USER instruction is loaded and the JTAG TAP controller is in the SHIFT-DR state. DRK1 applies to the USER1 logic while DRK2 applies to USER2.
RESET	Output	1	Active upon the loading of the USER instruction. It asserts High when the JTAG TAP controller is in the TEST-LOGIC-RESET state.
SEL1, SEL2	Output	1	Indicates when the USER1 or USER2 instruction has been loaded into the JTAG Instruction Register. SEL1 or SEL2 becomes active in the UPDATE-IR state, and stays active until a new instruction is loaded.
SHIFT	Output	1	Active upon the loading of the USER instruction. It asserts High when the JTAG TAP controller is in the SHIFT-DR state.
CAPTURE	Output	1	Active upon the loading of the USER instruction. Asserts High when the JTAG TAP controller is in the CAPTURE-DR state.
UPDATE	Output	1	Active upon the loading of the USER instruction. It asserts High when the JTAG TAP controller is in the UPDATE-DR state.
TDO1, TDO2	Input	1	Active upon the loading of the USER1 or USER2 instruction. External JTAG TDO pin reflects data input to the component's TDO1 (USER1) or TDO2 (USER2) pin.

Design Entry Method

This design element can be used in schematics.

For More Information

- See the [Spartan-3 Generation FPGA User Guide \(UG331\)](#).
- See the [Spartan-3E FPGA Family Data Sheet \(DS312\)](#).

BUF

Primitive: General Purpose Buffer

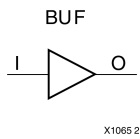

Introduction

This is a general-purpose, non-inverting buffer.

This element is not necessary and is removed by the partitioning software (MAP).

Design Entry Method

This design element is only for use in schematics.

For More Information

- See the [Spartan-3 Generation FPGA User Guide \(UG331\)](#).
- See the [Spartan-3E FPGA Family Data Sheet \(DS312\)](#).

BUFCF

Primitive: Fast Connect Buffer

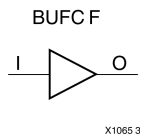

Introduction

This design element is a single fast connect buffer used to connect the outputs of the LUTs and some dedicated logic directly to the input of another LUT. Using this buffer implies CLB packing. No more than four LUTs may be connected together as a group.

Design Entry Method

This design element can be used in schematics.

For More Information

- See the [Spartan-3 Generation FPGA User Guide \(UG331\)](#).
- See the [Spartan-3E FPGA Family Data Sheet \(DS312\)](#).

BUFG

Primitive: Global Clock Buffer

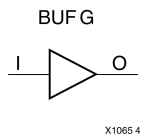

Introduction

This design element is a high-fanout buffer that connects signals to the global routing resources for low skew distribution of the signal. BUFGs are typically used on clock nets as well other high fanout nets like sets/resets and clock enables.

Port Descriptions

Port	Direction	Width	Function
I	Input	1	Clock buffer input
O	Output	1	Clock buffer output

Design Entry Method

This design element can be used in schematics.

For More Information

- See the [Spartan-3 Generation FPGA User Guide \(UG331\)](#).
- See the [Spartan-3E FPGA Family Data Sheet \(DS312\)](#).

BUFGCE

Primitive: Global Clock Buffer with Clock Enable

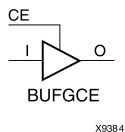

Introduction

This design element is a global clock buffer with a single gated input. Its O output is "0" when clock enable (CE) is Low (inactive). When clock enable (CE) is High, the I input is transferred to the O output.

Logic Table

Inputs		Outputs
I	CE	O
X	0	0
I	1	I

Port Descriptions

Port	Direction	Width	Function
I	Input	1	Clock buffer input
CE	Input	1	Clock enable input
O	Output	1	Clock buffer output

Design Entry Method

This design element can be used in schematics.

For More Information

- See the [Spartan-3 Generation FPGA User Guide \(UG331\)](#).
- See the [Spartan-3E FPGA Family Data Sheet \(DS312\)](#).

BUFGCE_1

Primitive: Global Clock Buffer with Clock Enable and Output State 1

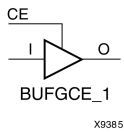

Introduction

This design element is a multiplexed global clock buffer with a single gated input. Its O output is High (1) when clock enable (CE) is Low (inactive). When clock enable (CE) is High, the I input is transferred to the O output.

Logic Table

Inputs		Outputs
I	CE	O
X	0	1
I	1	I

Port Descriptions

Port	Direction	Width	Function
I	Input	1	Clock buffer input
CE	Input	1	Clock enable input
O	Output	1	Clock buffer output

Design Entry Method

This design element can be used in schematics.

For More Information

- See the [Spartan-3 Generation FPGA User Guide \(UG331\)](#).
- See the [Spartan-3E FPGA Family Data Sheet \(DS312\)](#).

BUFGMUX

Primitive: Global Clock MUX Buffer

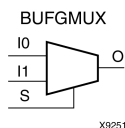

Introduction

BUFGMUX is a multiplexed global clock buffer that can select between two input clocks: I0 and I1. When the select input (S) is Low, the signal on I0 is selected for output (O). When the select input (S) is High, the signal on I1 is selected for output.

BUFGMUX and BUFGMUX_1 are distinguished by the state the output assumes when that output switches between clocks in response to a change in its select input. BUFGMUX assumes output state 0 and BUFGMUX_1 assumes output state 1.

Note BUFGMUX guarantees that when S is toggled, the state of the output remains in the inactive state until the next active clock edge (either I0 or I1) occurs.

Logic Table

Inputs			Outputs
I0	I1	S	O
I0	X	0	I0
X	I1	1	I1
X	X	↑	0
X	X	↓	0

Port Descriptions

Port	Direction	Width	Function
I0	Input	1	Clock0 input
I1	Input	1	Clock1 input
O	Output	1	Clock MUX output
S	Input	1	Clock select input

Design Entry Method

This design element can be used in schematics.

For More Information

- See the [Spartan-3 Generation FPGA User Guide \(UG331\)](#).
- See the [Spartan-3E FPGA Family Data Sheet \(DS312\)](#).

BUFGMUX_1

Primitive: Global Clock MUX Buffer with Output State 1

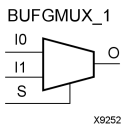

Introduction

This design element is a multiplexed global clock buffer that can select between two input clocks: I0 and I1. When the select input (S) is Low, the signal on I0 is selected for output (O). When the select input (S) is High, the signal on I1 is selected for output.

This design element is distinguished from BUFGMUX by the state the output assumes when that output switches between clocks in response to a change in its select input. BUFGMUX assumes output state 0 and BUFGMUX_1 assumes output state 1.

Logic Table

Inputs			Outputs
I0	I1	S	O
I0	X	0	I0
X	I1	1	I1
X	X	↑	1
X	X	↓	1

Port Descriptions

Port	Direction	Width	Function
I0	Input	1	Clock0 input
I1	Input	1	Clock1 input
O	Output	1	Clock MUX output
S	Input	1	Clock select input

Design Entry Method

This design element can be used in schematics.

For More Information

- See the [Spartan-3 Generation FPGA User Guide \(UG331\)](#).
- See the [Spartan-3E FPGA Family Data Sheet \(DS312\)](#).

CAPTURE_SPARTAN3

Primitive: Spartan®-3 Register State Capture for Bitstream Readback

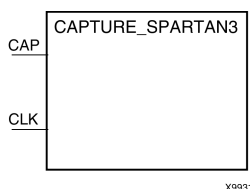

Introduction

This element provides user control and synchronization over when and how the capture register (flip-flop and latch) information task is requested. The readback function is provided through dedicated configuration port instructions. However, without this element, the readback data is synchronized to the configuration clock. Only register (flip-flop and latch) states can be captured. Although LUT RAM, SRL, and block RAM states are readback, they cannot be captured.

An asserted high CAP signal indicates that the registers in the device are to be captured at the next Low-to-High clock transition. By default, data is captured after every trigger when transition on CLK while CAP is asserted. To limit the readback operation to a single data capture, add the ONESHOT=TRUE attribute to this element.

Port Descriptions

Port	Direction	Width	Function
CAP	Input	1	Readback capture trigger
CLK	Input	1	Readback capture clock

Design Entry Method

This design element can be used in schematics.

Connect all inputs and outputs to the design in order to ensure proper operation.

Available Attributes

Attribute	Data Type	Allowed Values	Default	Description
ONESHOT	Boolean	TRUE, FALSE	TRUE	Specifies the procedure for performing single readback per CAP trigger.

For More Information

- See the [Spartan-3 Generation FPGA User Guide \(UG331\)](#).
- See the [Spartan-3E FPGA Family Data Sheet \(DS312\)](#).

CB16CE

Macro: 16-Bit Cascadable Binary Counter with Clock Enable and Asynchronous Clear

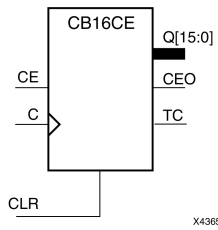

Introduction

This design element is an asynchronously clearable, cascadable binary counter. The asynchronous clear (CLR) input, when High, overrides all other inputs and forces the Q outputs, terminal count (TC), and clock enable out (CEO) to logic level zero, independent of clock transitions. The Q outputs increment when the clock enable input (CE) is High during the Low-to-High clock (C) transition. The counter ignores clock transitions when CE is Low. The TC output is High when all Q outputs are High.

Create larger counters by connecting the CEO output of each stage to the CE input of the next stage and connecting the C and CLR inputs in parallel. CEO is active (High) when TC and CE are High. The maximum length of the counter is determined by the accumulated CE-to-TC propagation delays versus the clock period. The clock period must be greater than $n(t_{CE-TC})$, where n is the number of stages and the time t_{CE-TC} is the CE-to-TC propagation delay of each stage. When cascading counters, use the CEO output if the counter uses the CE input or use the TC output if it does not.

This counter is asynchronously cleared, outputs Low, when power is applied. For FPGA devices, power-on conditions are simulated when global set/reset (GSR) is active. GSR defaults to active-High but can be inverted by adding an inverter in front of the GSR input of the appropriate `STARTUP_architecture` symbol.

Logic Table

Inputs			Outputs		
CLR	CE	C	Qz-Q0	TC	CEO
1	X	X	0	0	0
0	0	X	No change	No change	0
0	1	↑	Inc	TC	CEO

z = bit width - 1
 $TC = Qz \cdot Q(z-1) \cdot Q(z-2) \cdot \dots \cdot Q0$
 $CEO = TC \cdot CE$

Design Entry Method

This design element is only for use in schematics.

For More Information

- See the [Spartan-3 Generation FPGA User Guide \(UG331\)](#).
- See the [Spartan-3E FPGA Family Data Sheet \(DS312\)](#).

CB16CLE

Macro: 16-Bit Loadable Cascadable Binary Counters with Clock Enable and Asynchronous Clear

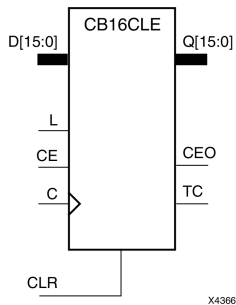

Introduction

This element is a synchronously loadable, asynchronously clearable, cascadable binary counter. The asynchronous clear (CLR) input, when High, overrides all other inputs and forces the Q outputs, terminal count (TC), and clock enable out (CEO) to logic level zero, independent of clock transitions. The data on the D inputs is loaded into the counter when the load enable input (L) is High during the Low-to-High clock transition, independent of the state of clock enable (CE). The Q outputs increment when CE is High during the Low-to-High clock transition. The counter ignores clock transitions when CE is Low. The TC output is High when all Q outputs are High.

Create larger counters by connecting the CEO output of each stage to the CE input of the next stage and connecting the C, L, and CLR inputs in parallel. CEO is active (High) when TC and CE are High. The maximum length of the counter is determined by the accumulated CE-to-TC propagation delays versus the clock period. The clock period must be greater than $n(t_{CE-TC})$, where n is the number of stages and the time t_{CE-TC} is the CE-to-TC propagation delay of each stage. When cascading counters, use the CEO output if the counter uses the CE input or use the TC output if it does not.

This counter is asynchronously cleared, outputs Low, when power is applied. For FPGA devices, power-on conditions are simulated when global set/reset (GSR) is active. GSR defaults to active-High but can be inverted by adding an inverter in front of the GSR input of the appropriate `STARTUP_architecture` symbol.

Logic Table

Inputs					Outputs		
CLR	L	CE	C	Dz-D0	Qz-Q0	TC	CEO
1	X	X	X	X	0	0	0
0	1	X	↑	Dn	Dn	TC	CEO
0	0	0	X	X	No change	No change	0
0	0	1	↑	X	Inc	TC	CEO

z = bit width - 1
 TC = Qz•Q(z-1)•Q(z-2)•...•Q0
 CEO = TC•CE

Design Entry Method

This design element is only for use in schematics.

For More Information

- See the [Spartan-3 Generation FPGA User Guide \(UG331\)](#).
- See the [Spartan-3E FPGA Family Data Sheet \(DS312\)](#).

CB16CLED

Macro: 16-Bit Loadable Cascadable Bidirectional Binary Counters with Clock Enable and Asynchronous Clear

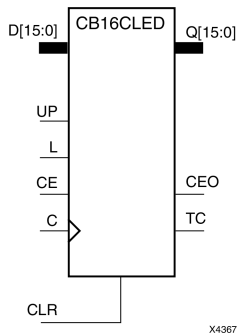

Introduction

This design element is a synchronously loadable, asynchronously clearable, cascadable, bidirectional binary counter. The asynchronous clear (CLR) input, when High, overrides all other inputs and forces the Q outputs, terminal count (TC), and clock enable out (CEO) to logic level zero, independent of clock transitions. The data on the D inputs is loaded into the counter when the load enable input (L) is High during the Low-to-High clock (C) transition, independent of the state of clock enable (CE). The Q outputs decrement when CE is High and UP is Low during the Low-to-High clock transition. The Q outputs increment when CE and UP are High. The counter ignores clock transitions when CE is Low.

For counting up, the TC output is High when all Q outputs and UP are High. For counting down, the TC output is High when all Q outputs and UP are Low.

Create larger counters by connecting the CEO output of each stage to the CE input of the next stage and connecting the C, UP, L, and CLR inputs in parallel. CEO is active (High) when TC and CE are High. The maximum length of the counter is determined by the accumulated CE-to-TC propagation delays versus the clock period. The clock period must be greater than $n(t_{CE-TC})$, where n is the number of stages and the time t_{CE-TC} is the CE-to-TC propagation delay of each stage. When cascading counters, use the CEO output if the counter uses the CE input or use the TC output if it does not.

For CPLD parts, see CB2X1, CB4X1, CB8X1, CB16X1 for high-performance cascadable, bidirectional counters.

This counter is asynchronously cleared, outputs Low, when power is applied. For FPGA devices, power-on conditions are simulated when global set/reset (GSR) is active. GSR defaults to active-High but can be inverted by adding an inverter in front of the GSR input of the appropriate `STARTUP_architecture` symbol.

Logic Table

Inputs						Outputs		
CLR	L	CE	C	UP	Dz-D0	Qz-Q0	TC	CEO
1	X	X	X	X	X	0	0	0
0	1	X	↑	X	Dn	Dn	TC	CEO
0	0	0	X	X	X	No change	No change	0
0	0	1	↑	1	X	Inc	TC	CEO
0	0	1	↑	0	X	Dec	TC	CEO

z = bit width - 1

$$TC = (Qz \cdot Q(z-1) \cdot Q(z-2) \cdot \dots \cdot Q0 \cdot UP) + (Qz \cdot Q(z-1) \cdot Q(z-2) \cdot \dots \cdot Q0 \cdot \overline{UP})$$

$$CEO = TC \cdot CE$$

Design Entry Method

This design element is only for use in schematics.

For More Information

- See the [Spartan-3 Generation FPGA User Guide \(UG331\)](#).
- See the [Spartan-3E FPGA Family Data Sheet \(DS312\)](#).

CB16RE

Macro: 16-Bit Cascadable Binary Counter with Clock Enable and Synchronous Reset

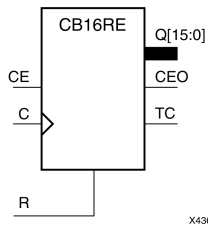

Introduction

This design element is a synchronous, resettable, cascadable binary counter. The synchronous reset (R), when High, overrides all other inputs and forces the Q outputs, terminal count (TC), and clock enable out (CEO) to zero on the Low-to-High clock transition. The Q outputs increment when the clock enable input (CE) is High during the Low-to-High clock (C) transition. The counter ignores clock transitions when CE is Low. The TC output is High when both Q outputs are High.

Create larger counters by connecting the CEO output of each stage to the CE input of the next stage and connecting the C and R inputs in parallel. CEO is active (High) when TC and CE are High. The maximum length of the counter is determined by the accumulated CE-to-TC propagation delays versus the clock period. The clock period must be greater than $n(t_{CE-TC})$, where n is the number of stages and the time t_{CE-TC} is the CE-to-TC propagation delay of each stage. When cascading counters, use the CEO output if the counter uses the CE input or use the TC output if it does not.

This counter is asynchronously cleared, outputs Low, when power is applied. For FPGA devices, power-on conditions are simulated when global set/reset (GSR) is active. GSR defaults to active-High but can be inverted by adding an inverter in front of the GSR input of the appropriate `STARTUP_architecture` symbol.

Logic Table

Inputs			Outputs		
R	CE	C	Qz-Q0	TC	CEO
1	X	↑	0	0	0
0	0	X	No change	No change	0
0	1	↑	Inc	TC	CEO

z = bit width - 1
 $TC = Qz \cdot Q(z-1) \cdot Q(z-2) \cdot \dots \cdot Q0$
 $CEO = TC \cdot CE$

Design Entry Method

This design element is only for use in schematics.

For More Information

- See the [Spartan-3 Generation FPGA User Guide \(UG331\)](#).
- See the [Spartan-3E FPGA Family Data Sheet \(DS312\)](#).

CB2CE

Macro: 2-Bit Cascadable Binary Counter with Clock Enable and Asynchronous Clear

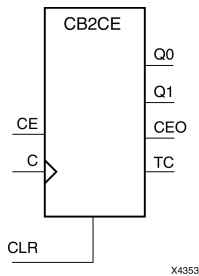

Introduction

This design element is an asynchronously clearable, cascadable binary counter. The asynchronous clear (CLR) input, when High, overrides all other inputs and forces the Q outputs, terminal count (TC), and clock enable out (CEO) to logic level zero, independent of clock transitions. The Q outputs increment when the clock enable input (CE) is High during the Low-to-High clock (C) transition. The counter ignores clock transitions when CE is Low. The TC output is High when all Q outputs are High.

Create larger counters by connecting the CEO output of each stage to the CE input of the next stage and connecting the C and CLR inputs in parallel. CEO is active (High) when TC and CE are High. The maximum length of the counter is determined by the accumulated CE-to-TC propagation delays versus the clock period. The clock period must be greater than $n(t_{CE-TC})$, where n is the number of stages and the time t_{CE-TC} is the CE-to-TC propagation delay of each stage. When cascading counters, use the CEO output if the counter uses the CE input or use the TC output if it does not.

This counter is asynchronously cleared, outputs Low, when power is applied. For FPGA devices, power-on conditions are simulated when global set/reset (GSR) is active. GSR defaults to active-High but can be inverted by adding an inverter in front of the GSR input of the appropriate `STARTUP_architecture` symbol.

Logic Table

Inputs			Outputs		
CLR	CE	C	Qz-Q0	TC	CEO
1	X	X	0	0	0
0	0	X	No change	No change	0
0	1	↑	Inc	TC	CEO

$z = \text{bit width} - 1$
 $TC = Q_z \cdot Q_{(z-1)} \cdot Q_{(z-2)} \cdot \dots \cdot Q_0$
 $CEO = TC \cdot CE$

Design Entry Method

This design element is only for use in schematics.

For More Information

- See the [Spartan-3 Generation FPGA User Guide \(UG331\)](#).
- See the [Spartan-3E FPGA Family Data Sheet \(DS312\)](#).

CB2CLE

Macro: 2-Bit Loadable Cascadable Binary Counters with Clock Enable and Asynchronous Clear

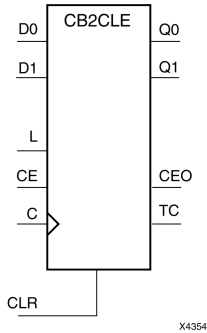

Introduction

This element is a synchronously loadable, asynchronously clearable, cascadable binary counter. The asynchronous clear (CLR) input, when High, overrides all other inputs and forces the Q outputs, terminal count (TC), and clock enable out (CEO) to logic level zero, independent of clock transitions. The data on the D inputs is loaded into the counter when the load enable input (L) is High during the Low-to-High clock transition, independent of the state of clock enable (CE). The Q outputs increment when CE is High during the Low-to-High clock transition. The counter ignores clock transitions when CE is Low. The TC output is High when all Q outputs are High.

Create larger counters by connecting the CEO output of each stage to the CE input of the next stage and connecting the C, L, and CLR inputs in parallel. CEO is active (High) when TC and CE are High. The maximum length of the counter is determined by the accumulated CE-to-TC propagation delays versus the clock period. The clock period must be greater than $n(t_{CE-TC})$, where n is the number of stages and the time t_{CE-TC} is the CE-to-TC propagation delay of each stage. When cascading counters, use the CEO output if the counter uses the CE input or use the TC output if it does not.

This counter is asynchronously cleared, outputs Low, when power is applied. For FPGA devices, power-on conditions are simulated when global set/reset (GSR) is active. GSR defaults to active-High but can be inverted by adding an inverter in front of the GSR input of the appropriate `STARTUP_architecture` symbol.

Logic Table

Inputs					Outputs		
CLR	L	CE	C	Dz-D0	Qz-Q0	TC	CEO
1	X	X	X	X	0	0	0
0	1	X	↑	Dn	Dn	TC	CEO
0	0	0	X	X	No change	No change	0
0	0	1	↑	X	Inc	TC	CEO

z = bit width - 1
 $TC = Qz \cdot Q(z-1) \cdot Q(z-2) \cdot \dots \cdot Q0$
 $CEO = TC \cdot CE$

Design Entry Method

This design element is only for use in schematics.

For More Information

- See the [Spartan-3 Generation FPGA User Guide \(UG331\)](#).
- See the [Spartan-3E FPGA Family Data Sheet \(DS312\)](#).

CB2CLEDD

Macro: 2-Bit Loadable Cascadable Bidirectional Binary Counters with Clock Enable and Asynchronous Clear

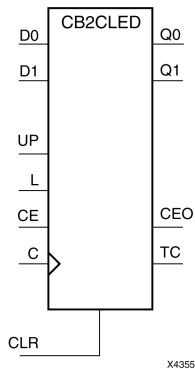

Introduction

This design element is a synchronously loadable, asynchronously clearable, cascadable, bidirectional binary counter. The asynchronous clear (CLR) input, when High, overrides all other inputs and forces the Q outputs, terminal count (TC), and clock enable out (CEO) to logic level zero, independent of clock transitions. The data on the D inputs is loaded into the counter when the load enable input (L) is High during the Low-to-High clock (C) transition, independent of the state of clock enable (CE). The Q outputs decrement when CE is High and UP is Low during the Low-to-High clock transition. The Q outputs increment when CE and UP are High. The counter ignores clock transitions when CE is Low.

For counting up, the TC output is High when all Q outputs and UP are High. For counting down, the TC output is High when all Q outputs and UP are Low.

Create larger counters by connecting the CEO output of each stage to the CE input of the next stage and connecting the C, UP, L, and CLR inputs in parallel. CEO is active (High) when TC and CE are High. The maximum length of the counter is determined by the accumulated CE-to-TC propagation delays versus the clock period. The clock period must be greater than $n(t_{CE-TC})$, where n is the number of stages and the time t_{CE-TC} is the CE-to-TC propagation delay of each stage. When cascading counters, use the CEO output if the counter uses the CE input or use the TC output if it does not.

For CPLD parts, see CB2X1, CB4X1, CB8X1, CB16X1 for high-performance cascadable, bidirectional counters.

This counter is asynchronously cleared, outputs Low, when power is applied. For FPGA devices, power-on conditions are simulated when global set/reset (GSR) is active. GSR defaults to active-High but can be inverted by adding an inverter in front of the GSR input of the appropriate `STARTUP_architecture` symbol.

Logic Table

Inputs						Outputs		
CLR	L	CE	C	UP	Dz-D0	Qz-Q0	TC	CEO
1	X	X	X	X	X	0	0	0
0	1	X	↑	X	Dn	Dn	TC	CEO
0	0	0	X	X	X	No change	No change	0
0	0	1	↑	1	X	Inc	TC	CEO
0	0	1	↑	0	X	Dec	TC	CEO

z = bit width - 1

$$TC = (Qz \cdot Q(z-1) \cdot Q(z-2) \cdot \dots \cdot Q0 \cdot UP) + (Qz \cdot Q(z-1) \cdot Q(z-2) \cdot \dots \cdot Q0 \cdot \overline{UP})$$

$$CEO = TC \cdot CE$$

Design Entry Method

This design element is only for use in schematics.

For More Information

- See the [Spartan-3 Generation FPGA User Guide \(UG331\)](#).
- See the [Spartan-3E FPGA Family Data Sheet \(DS312\)](#).

CB2RE

Macro: 2-Bit Cascadable Binary Counter with Clock Enable and Synchronous Reset

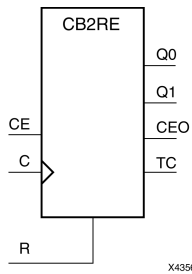

Introduction

This design element is a synchronous, resettable, cascadable binary counter. The synchronous reset (R), when High, overrides all other inputs and forces the Q outputs, terminal count (TC), and clock enable out (CEO) to zero on the Low-to-High clock transition. The Q outputs increment when the clock enable input (CE) is High during the Low-to-High clock (C) transition. The counter ignores clock transitions when CE is Low. The TC output is High when both Q outputs are High.

Create larger counters by connecting the CEO output of each stage to the CE input of the next stage and connecting the C and R inputs in parallel. CEO is active (High) when TC and CE are High. The maximum length of the counter is determined by the accumulated CE-to-TC propagation delays versus the clock period. The clock period must be greater than $n (t_{CE-TC})$, where n is the number of stages and the time t_{CE-TC} is the CE-to-TC propagation delay of each stage. When cascading counters, use the CEO output if the counter uses the CE input or use the TC output if it does not.

This counter is asynchronously cleared, outputs Low, when power is applied. For FPGA devices, power-on conditions are simulated when global set/reset (GSR) is active. GSR defaults to active-High but can be inverted by adding an inverter in front of the GSR input of the appropriate `STARTUP_architecture` symbol.

Logic Table

Inputs			Outputs		
R	CE	C	Qz-Q0	TC	CEO
1	X	↑	0	0	0
0	0	X	No change	No change	0
0	1	↑	Inc	TC	CEO

$z = \text{bit width} - 1$
 $TC = Q_z \cdot Q_{(z-1)} \cdot Q_{(z-2)} \cdot \dots \cdot Q_0$
 $CEO = TC \cdot CE$

Design Entry Method

This design element is only for use in schematics.

For More Information

- See the [Spartan-3 Generation FPGA User Guide \(UG331\)](#).
- See the [Spartan-3E FPGA Family Data Sheet \(DS312\)](#).

CB4CE

Macro: 4-Bit Cascadable Binary Counter with Clock Enable and Asynchronous Clear

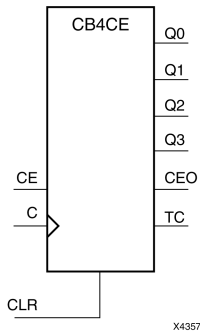

Introduction

This design element is an asynchronously clearable, cascadable binary counter. The asynchronous clear (CLR) input, when High, overrides all other inputs and forces the Q outputs, terminal count (TC), and clock enable out (CEO) to logic level zero, independent of clock transitions. The Q outputs increment when the clock enable input (CE) is High during the Low-to-High clock (C) transition. The counter ignores clock transitions when CE is Low. The TC output is High when all Q outputs are High.

Create larger counters by connecting the CEO output of each stage to the CE input of the next stage and connecting the C and CLR inputs in parallel. CEO is active (High) when TC and CE are High. The maximum length of the counter is determined by the accumulated CE-to-TC propagation delays versus the clock period. The clock period must be greater than $n(t_{CE-TC})$, where n is the number of stages and the time t_{CE-TC} is the CE-to-TC propagation delay of each stage. When cascading counters, use the CEO output if the counter uses the CE input or use the TC output if it does not.

This counter is asynchronously cleared, outputs Low, when power is applied. For FPGA devices, power-on conditions are simulated when global set/reset (GSR) is active. GSR defaults to active-High but can be inverted by adding an inverter in front of the GSR input of the appropriate `STARTUP_architecture` symbol.

Logic Table

Inputs			Outputs		
CLR	CE	C	Qz-Q0	TC	CEO
1	X	X	0	0	0
0	0	X	No change	No change	0
0	1	↑	Inc	TC	CEO
$z = \text{bit width} - 1$ $TC = Qz \cdot Q(z-1) \cdot Q(z-2) \cdot \dots \cdot Q0$ $CEO = TC \cdot CE$					

Design Entry Method

This design element is only for use in schematics.

For More Information

- See the [Spartan-3 Generation FPGA User Guide \(UG331\)](#).
- See the [Spartan-3E FPGA Family Data Sheet \(DS312\)](#).

CB4CLE

Macro: 4-Bit Loadable Cascadable Binary Counters with Clock Enable and Asynchronous Clear

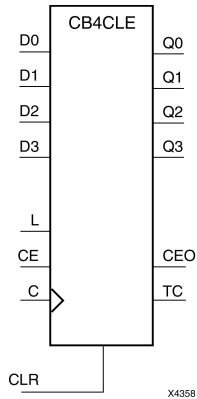

Introduction

This element is a synchronously loadable, asynchronously clearable, cascadable binary counter. The asynchronous clear (CLR) input, when High, overrides all other inputs and forces the Q outputs, terminal count (TC), and clock enable out (CEO) to logic level zero, independent of clock transitions. The data on the D inputs is loaded into the counter when the load enable input (L) is High during the Low-to-High clock transition, independent of the state of clock enable (CE). The Q outputs increment when CE is High during the Low-to-High clock transition. The counter ignores clock transitions when CE is Low. The TC output is High when all Q outputs are High.

Create larger counters by connecting the CEO output of each stage to the CE input of the next stage and connecting the C, L, and CLR inputs in parallel. CEO is active (High) when TC and CE are High. The maximum length of the counter is determined by the accumulated CE-to-TC propagation delays versus the clock period. The clock period must be greater than $n(t_{CE-TC})$, where n is the number of stages and the time t_{CE-TC} is the CE-to-TC propagation delay of each stage. When cascading counters, use the CEO output if the counter uses the CE input or use the TC output if it does not.

This counter is asynchronously cleared, outputs Low, when power is applied. For FPGA devices, power-on conditions are simulated when global set/reset (GSR) is active. GSR defaults to active-High but can be inverted by adding an inverter in front of the GSR input of the appropriate *STARTUP_architecture* symbol.

Logic Table

Inputs					Outputs		
CLR	L	CE	C	Dz-D0	Qz-Q0	TC	CEO
1	X	X	X	X	0	0	0
0	1	X	↑	Dn	Dn	TC	CEO
0	0	0	X	X	No change	No change	0
0	0	1	↑	X	Inc	TC	CEO

z = bit width - 1
 $TC = Qz \cdot Q(z-1) \cdot Q(z-2) \cdot \dots \cdot Q0$
 $CEO = TC \cdot CE$

Design Entry Method

This design element is only for use in schematics.

For More Information

- See the [Spartan-3 Generation FPGA User Guide \(UG331\)](#).
- See the [Spartan-3E FPGA Family Data Sheet \(DS312\)](#).

CB4CLED

Macro: 4-Bit Loadable Cascadable Bidirectional Binary Counters with Clock Enable and Asynchronous Clear

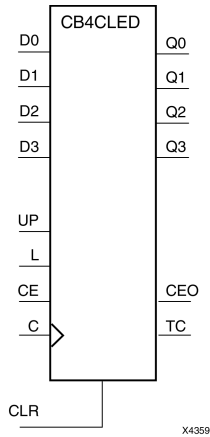

Introduction

This design element is a synchronously loadable, asynchronously clearable, cascadable, bidirectional binary counter. The asynchronous clear (CLR) input, when High, overrides all other inputs and forces the Q outputs, terminal count (TC), and clock enable out (CEO) to logic level zero, independent of clock transitions. The data on the D inputs is loaded into the counter when the load enable input (L) is High during the Low-to-High clock (C) transition, independent of the state of clock enable (CE). The Q outputs decrement when CE is High and UP is Low during the Low-to-High clock transition. The Q outputs increment when CE and UP are High. The counter ignores clock transitions when CE is Low.

For counting up, the TC output is High when all Q outputs and UP are High. For counting down, the TC output is High when all Q outputs and UP are Low.

Create larger counters by connecting the CEO output of each stage to the CE input of the next stage and connecting the C, UP, L, and CLR inputs in parallel. CEO is active (High) when TC and CE are High. The maximum length of the counter is determined by the accumulated CE-to-TC propagation delays versus the clock period. The clock period must be greater than $n(t_{CE-TC})$, where n is the number of stages and the time t_{CE-TC} is the CE-to-TC propagation delay of each stage. When cascading counters, use the CEO output if the counter uses the CE input or use the TC output if it does not.

For CPLD parts, see CB2X1, CB4X1, CB8X1, CB16X1 for high-performance cascadable, bidirectional counters.

This counter is asynchronously cleared, outputs Low, when power is applied. For FPGA devices, power-on conditions are simulated when global set/reset (GSR) is active. GSR defaults to active-High but can be inverted by adding an inverter in front of the GSR input of the appropriate `STARTUP_architecture` symbol.

Logic Table

Inputs						Outputs		
CLR	L	CE	C	UP	Dz-D0	Qz-Q0	TC	CEO
1	X	X	X	X	X	0	0	0
0	1	X	↑	X	Dn	Dn	TC	CEO
0	0	0	X	X	X	No change	No change	0
0	0	1	↑	1	X	Inc	TC	CEO

Inputs						Outputs		
CLR	L	CE	C	UP	Dz-D0	Qz-Q0	TC	CEO
0	0	1	↑	0	X	Dec	TC	CEO
$z = \text{bit width} - 1$ $TC = (Qz \cdot Q(z-1) \cdot Q(z-2) \cdot \dots \cdot Q0 \cdot UP) + (Qz \cdot Q(z-1) \cdot Q(z-2) \cdot \dots \cdot Q0 \cdot UP)$ $CEO = TC \cdot CE$								

Design Entry Method

This design element is only for use in schematics.

For More Information

- See the [Spartan-3 Generation FPGA User Guide \(UG331\)](#).
- See the [Spartan-3E FPGA Family Data Sheet \(DS312\)](#).

CB4RE

Macro: 4-Bit Cascadable Binary Counter with Clock Enable and Synchronous Reset

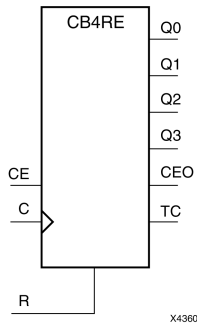

Introduction

This design element is a synchronous, resettable, cascadable binary counter. The synchronous reset (R), when High, overrides all other inputs and forces the Q outputs, terminal count (TC), and clock enable out (CEO) to zero on the Low-to-High clock transition. The Q outputs increment when the clock enable input (CE) is High during the Low-to-High clock (C) transition. The counter ignores clock transitions when CE is Low. The TC output is High when both Q outputs are High.

Create larger counters by connecting the CEO output of each stage to the CE input of the next stage and connecting the C and R inputs in parallel. CEO is active (High) when TC and CE are High. The maximum length of the counter is determined by the accumulated CE-to-TC propagation delays versus the clock period. The clock period must be greater than $n (t_{CE-TC})$, where n is the number of stages and the time t_{CE-TC} is the CE-to-TC propagation delay of each stage. When cascading counters, use the CEO output if the counter uses the CE input or use the TC output if it does not.

This counter is asynchronously cleared, outputs Low, when power is applied. For FPGA devices, power-on conditions are simulated when global set/reset (GSR) is active. GSR defaults to active-High but can be inverted by adding an inverter in front of the GSR input of the appropriate `STARTUP_architecture` symbol.

Logic Table

Inputs			Outputs		
R	CE	C	Qz-Q0	TC	CEO
1	X	↑	0	0	0
0	0	X	No change	No change	0
0	1	↑	Inc	TC	CEO

z = bit width - 1
 $TC = Qz \cdot Q(z-1) \cdot Q(z-2) \cdot \dots \cdot Q0$
 $CEO = TC \cdot CE$

Design Entry Method

This design element is only for use in schematics.

For More Information

- See the [Spartan-3 Generation FPGA User Guide \(UG331\)](#).
- See the [Spartan-3E FPGA Family Data Sheet \(DS312\)](#).

CB8CE

Macro: 8-Bit Cascadable Binary Counter with Clock Enable and Asynchronous Clear

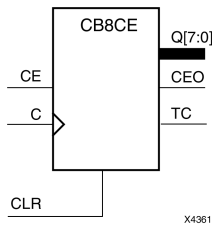

Introduction

This design element is an asynchronously clearable, cascadable binary counter. The asynchronous clear (CLR) input, when High, overrides all other inputs and forces the Q outputs, terminal count (TC), and clock enable out (CEO) to logic level zero, independent of clock transitions. The Q outputs increment when the clock enable input (CE) is High during the Low-to-High clock (C) transition. The counter ignores clock transitions when CE is Low. The TC output is High when all Q outputs are High.

Create larger counters by connecting the CEO output of each stage to the CE input of the next stage and connecting the C and CLR inputs in parallel. CEO is active (High) when TC and CE are High. The maximum length of the counter is determined by the accumulated CE-to-TC propagation delays versus the clock period. The clock period must be greater than $n(t_{CE-TC})$, where n is the number of stages and the time t_{CE-TC} is the CE-to-TC propagation delay of each stage. When cascading counters, use the CEO output if the counter uses the CE input or use the TC output if it does not.

This counter is asynchronously cleared, outputs Low, when power is applied. For FPGA devices, power-on conditions are simulated when global set/reset (GSR) is active. GSR defaults to active-High but can be inverted by adding an inverter in front of the GSR input of the appropriate `STARTUP_architecture` symbol.

Logic Table

Inputs			Outputs		
CLR	CE	C	Qz-Q0	TC	CEO
1	X	X	0	0	0
0	0	X	No change	No change	0
0	1	↑	Inc	TC	CEO

z = bit width - 1
 $TC = Qz \cdot Q(z-1) \cdot Q(z-2) \cdot \dots \cdot Q0$
 $CEO = TC \cdot CE$

Design Entry Method

This design element is only for use in schematics.

For More Information

- See the [Spartan-3 Generation FPGA User Guide \(UG331\)](#).
- See the [Spartan-3E FPGA Family Data Sheet \(DS312\)](#).

CB8CLE

Macro: 8-Bit Loadable Cascadable Binary Counters with Clock Enable and Asynchronous Clear

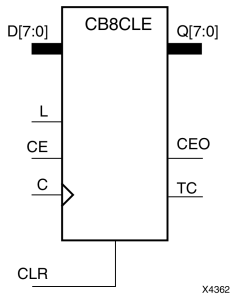

Introduction

This element is a synchronously loadable, asynchronously clearable, cascadable binary counter. The asynchronous clear (CLR) input, when High, overrides all other inputs and forces the Q outputs, terminal count (TC), and clock enable out (CEO) to logic level zero, independent of clock transitions. The data on the D inputs is loaded into the counter when the load enable input (L) is High during the Low-to-High clock transition, independent of the state of clock enable (CE). The Q outputs increment when CE is High during the Low-to-High clock transition. The counter ignores clock transitions when CE is Low. The TC output is High when all Q outputs are High.

Create larger counters by connecting the CEO output of each stage to the CE input of the next stage and connecting the C, L, and CLR inputs in parallel. CEO is active (High) when TC and CE are High. The maximum length of the counter is determined by the accumulated CE-to-TC propagation delays versus the clock period. The clock period must be greater than $n(t_{CE-TC})$, where n is the number of stages and the time t_{CE-TC} is the CE-to-TC propagation delay of each stage. When cascading counters, use the CEO output if the counter uses the CE input or use the TC output if it does not.

This counter is asynchronously cleared, outputs Low, when power is applied. For FPGA devices, power-on conditions are simulated when global set/reset (GSR) is active. GSR defaults to active-High but can be inverted by adding an inverter in front of the GSR input of the appropriate `STARTUP_architecture` symbol.

Logic Table

Inputs					Outputs		
CLR	L	CE	C	Dz-D0	Qz-Q0	TC	CEO
1	X	X	X	X	0	0	0
0	1	X	↑	Dn	Dn	TC	CEO
0	0	0	X	X	No change	No change	0
0	0	1	↑	X	Inc	TC	CEO

z = bit width - 1
 $TC = Qz \cdot Q(z-1) \cdot Q(z-2) \cdot \dots \cdot Q0$
 $CEO = TC \cdot CE$

Design Entry Method

This design element is only for use in schematics.

For More Information

- See the [Spartan-3 Generation FPGA User Guide \(UG331\)](#).
- See the [Spartan-3E FPGA Family Data Sheet \(DS312\)](#).

CB8CLED

Macro: 8-Bit Loadable Cascadable Bidirectional Binary Counters with Clock Enable and Asynchronous Clear

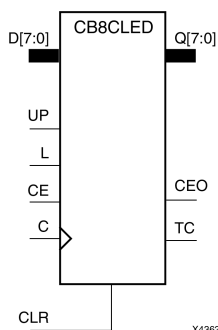

Introduction

This design element is a synchronously loadable, asynchronously clearable, cascadable, bidirectional binary counter. The asynchronous clear (CLR) input, when High, overrides all other inputs and forces the Q outputs, terminal count (TC), and clock enable out (CEO) to logic level zero, independent of clock transitions. The data on the D inputs is loaded into the counter when the load enable input (L) is High during the Low-to-High clock (C) transition, independent of the state of clock enable (CE). The Q outputs decrement when CE is High and UP is Low during the Low-to-High clock transition. The Q outputs increment when CE and UP are High. The counter ignores clock transitions when CE is Low.

For counting up, the TC output is High when all Q outputs and UP are High. For counting down, the TC output is High when all Q outputs and UP are Low.

Create larger counters by connecting the CEO output of each stage to the CE input of the next stage and connecting the C, UP, L, and CLR inputs in parallel. CEO is active (High) when TC and CE are High. The maximum length of the counter is determined by the accumulated CE-to-TC propagation delays versus the clock period. The clock period must be greater than $n(t_{CE-TC})$, where n is the number of stages and the time t_{CE-TC} is the CE-to-TC propagation delay of each stage. When cascading counters, use the CEO output if the counter uses the CE input or use the TC output if it does not.

For CPLD parts, see CB2X1, CB4X1, CB8X1, CB16X1 for high-performance cascadable, bidirectional counters.

This counter is asynchronously cleared, outputs Low, when power is applied. For FPGA devices, power-on conditions are simulated when global set/reset (GSR) is active. GSR defaults to active-High but can be inverted by adding an inverter in front of the GSR input of the appropriate *STARTUP_architecture* symbol.

Logic Table

Inputs						Outputs		
CLR	L	CE	C	UP	Dz-D0	Qz-Q0	TC	CEO
1	X	X	X	X	X	0	0	0
0	1	X	↑	X	Dn	Dn	TC	CEO
0	0	0	X	X	X	No change	No change	0
0	0	1	↑	1	X	Inc	TC	CEO
0	0	1	↑	0	X	Dec	TC	CEO

z = bit width - 1

$$TC = (Qz \cdot Q(z-1) \cdot Q(z-2) \cdot \dots \cdot Q0 \cdot UP) + (Qz \cdot Q(z-1) \cdot Q(z-2) \cdot \dots \cdot Q0 \cdot \overline{UP})$$

$$CEO = TC \cdot CE$$

Design Entry Method

This design element is only for use in schematics.

For More Information

- See the [Spartan-3 Generation FPGA User Guide \(UG331\)](#).
- See the [Spartan-3E FPGA Family Data Sheet \(DS312\)](#).

CB8RE

Macro: 8-Bit Cascadable Binary Counter with Clock Enable and Synchronous Reset

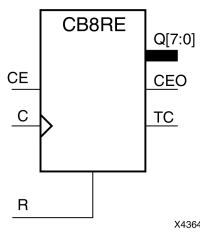

Introduction

This design element is a synchronous, resettable, cascadable binary counter. The synchronous reset (R), when High, overrides all other inputs and forces the Q outputs, terminal count (TC), and clock enable out (CEO) to zero on the Low-to-High clock (C) transition. The Q outputs increment when the clock enable input (CE) is High during the Low-to-High clock (C) transition. The counter ignores clock transitions when CE is Low. The TC output is High when both Q outputs are High.

Create larger counters by connecting the CEO output of each stage to the CE input of the next stage and connecting the C and R inputs in parallel. CEO is active (High) when TC and CE are High. The maximum length of the counter is determined by the accumulated CE-to-TC propagation delays versus the clock period. The clock period must be greater than $n(t_{CE-TC})$, where n is the number of stages and the time t_{CE-TC} is the CE-to-TC propagation delay of each stage. When cascading counters, use the CEO output if the counter uses the CE input or use the TC output if it does not.

This counter is asynchronously cleared, outputs Low, when power is applied. For FPGA devices, power-on conditions are simulated when global set/reset (GSR) is active. GSR defaults to active-High but can be inverted by adding an inverter in front of the GSR input of the appropriate `STARTUP_architecture` symbol.

Logic Table

Inputs			Outputs		
R	CE	C	Qz-Q0	TC	CEO
1	X	↑	0	0	0
0	0	X	No change	No change	0
0	1	↑	Inc	TC	CEO
$z = \text{bit width} - 1$ $TC = Qz \cdot Q(z-1) \cdot Q(z-2) \cdot \dots \cdot Q0$ $CEO = TC \cdot CE$					

Design Entry Method

This design element is only for use in schematics.

For More Information

- See the [Spartan-3 Generation FPGA User Guide \(UG331\)](#).
- See the [Spartan-3E FPGA Family Data Sheet \(DS312\)](#).

CC16CE

Macro: 16-Bit Cascadable Binary Counter with Clock Enable and Asynchronous Clear

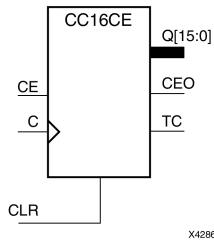

Introduction

This design element is an asynchronously clearable, cascadable binary counter. It is implemented using carry logic with relative location constraints to ensure efficient logic placement. The asynchronous clear (CLR) is the highest priority input. When CLR is High, all other inputs are ignored; the Q outputs, terminal count (TC), and clock enable out (CEO) go to logic level zero, independent of clock transitions. The Q outputs increment when the clock enable input (CE) is High during the Low-to-High clock (C) transition. The counter ignores clock transitions when CE is Low. The TC output is High when all Q outputs are High.

Create larger counters by connecting the CEO output of each stage to the CE input of the next stage and connecting the C and CLR inputs in parallel. CEO is active (High) when TC and CE are High. The maximum length of the counter is determined by the accumulated CE-to-TC propagation delays versus the clock period. The clock period must be greater than $n(t_{CE-TC})$, where n is the number of stages and the time t_{CE-TC} is the CE-to-TC propagation delay of each stage. When cascading counters, use the CEO output if the counter uses the CE input or use the TC output if it does not.

This counter is asynchronously cleared, outputs Low, when power is applied. For FPGA devices, power-on conditions are simulated when global set/reset (GSR) is active. GSR defaults to active-High but can be inverted by adding an inverter in front of the GSR input of the appropriate `STARTUP_architecture` symbol.

Logic Table

Inputs			Outputs		
CLR	CE	C	Qz-Q0	TC	CEO
1	X	X	0	0	0
0	0	X	No change	No change	0
0	1	↑	Inc	TC	CEO

z = bit width - 1
 $TC = Q_z \cdot Q_{(z-1)} \cdot Q_{(z-2)} \cdot \dots \cdot Q_0$
 $CEO = TC \cdot CE$

Design Entry Method

This design element is only for use in schematics.

For More Information

- See the [Spartan-3 Generation FPGA User Guide \(UG331\)](#).
- See the [Spartan-3E FPGA Family Data Sheet \(DS312\)](#).

CC16CLE

Macro: 16-Bit Loadable Cascadable Binary Counter with Clock Enable and Asynchronous Clear

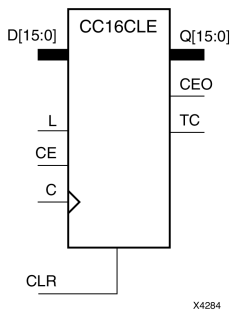

Introduction

This design element is a synchronously loadable, asynchronously clearable, cascadable binary counter. It is implemented using carry logic with relative location constraints to ensure efficient logic placement. The asynchronous clear (CLR) is the highest priority input. When CLR is High, all other inputs are ignored; the Q outputs, terminal count (TC), and clock enable out (CEO) go to logic level zero, independent of clock transitions. The data on the D inputs is loaded into the counter when the load enable input (L) is High during the Low-to-High clock (C) transition, independent of the state of clock enable (CE). The Q outputs increment when CE is High during the Low-to-High clock transition. The counter ignores clock transitions when CE is Low. The TC output is High when all Q outputs are High.

Create larger counters by connecting the CEO output of each stage to the CE input of the next stage and connecting the C, L, and CLR inputs in parallel. CEO is active (High) when TC and CE are High. The maximum length of the counter is determined by the accumulated CE-to-TC propagation delays versus the clock period. The clock period must be greater than $n(t_{CE-TC})$, where n is the number of stages and the time t_{CE-TC} is the CE-to-TC propagation delay of each stage. When cascading counters, use the CEO output if the counter uses the CE input or use the TC output if it does not.

This counter is asynchronously cleared, outputs Low, when power is applied. For FPGA devices, power-on conditions are simulated when global set/reset (GSR) is active. GSR defaults to active-High but can be inverted by adding an inverter in front of the GSR input of the appropriate `STARTUP_architecture` symbol.

Logic Table

Inputs					Outputs		
CLR	L	CE	C	Dz-D0	Qz-Q0	TC	CEO
1	X	X	X	X	0	0	0
0	1	X	↑	Dn	Dn	TC	CEO
0	0	0	X	X	No change	No change	0
0	0	1	↑	X	Inc	TC	CEO

z = bit width - 1
 $TC = Qz \cdot Q(z-1) \cdot Q(z-2) \cdot \dots \cdot Q0$
 $CEO = TC \cdot CE$

Design Entry Method

This design element is only for use in schematics.

For More Information

- See the [Spartan-3 Generation FPGA User Guide \(UG331\)](#).
- See the [Spartan-3E FPGA Family Data Sheet \(DS312\)](#).

CC16CLED

Macro: 16-Bit Loadable Cascadable Bidirectional Binary Counter with Clock Enable and Asynchronous Clear

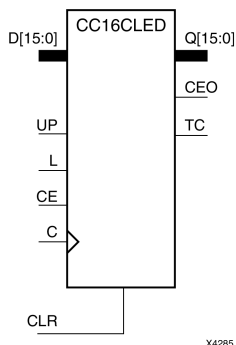

Introduction

This design element is a synchronously loadable, asynchronously clearable, cascadable, bidirectional binary counter. It is implemented using carry logic with relative location constraints, which assures most efficient logic placement. The asynchronous clear (CLR) is the highest priority input. When CLR is High, all other inputs are ignored; the Q outputs, terminal count (TC), and clock enable out (CEO) go to logic level zero, independent of clock transitions. The data on the D inputs is loaded into the counter when the load enable input (L) is High during the Low-to-High clock (C) transition, independent of the state of clock enable (CE). The Q outputs decrement when CE is High and UP is Low during the Low-to-High clock transition. The Q outputs increment when CE and UP are High. The counter ignores clock transitions when CE is Low.

For counting up, the TC output is High when all Q outputs and UP are High. For counting down, the TC output is High when all Q outputs and UP are Low.

Create larger counters by connecting the CEO output of each stage to the CE input of the next stage and connecting the C, UP, L, and CLR inputs in parallel. CEO is active (High) when TC and CE are High. The maximum length of the counter is determined by the accumulated CE-to-TC propagation delays versus the clock period. The clock period must be greater than $n (t_{CE-TC})$, where n is the number of stages and the time t_{CE-TC} is the CE-to-TC propagation delay of each stage. When cascading counters, use the CEO output if the counter uses the CE input or use the TC output if it does not.

This counter is asynchronously cleared, outputs Low, when power is applied. For FPGA devices, power-on conditions are simulated when global set/reset (GSR) is active. GSR defaults to active-High but can be inverted by adding an inverter in front of the GSR input of the appropriate STARTUP_ *architecture* symbol.

Logic Table

Inputs						Outputs		
CLR	L	CE	C	UP	Dz-D0	Qz-Q0	TC	CEO
1	X	X	X	X	X	0	0	0
0	1	X	↑	X	Dn	Dn	TC	CEO
0	0	0	X	X	X	No change	No change	0
0	0	1	↑	1	X	Inc	TC	CEO
0	0	1	↑	0	X	Dec	TC	CEO

z = bit width - 1

$$TC = (Qz \cdot Q(z-1) \cdot Q(z-2) \cdot \dots \cdot Q0 \cdot UP) + (Qz \cdot Q(z-1) \cdot Q(z-2) \cdot \dots \cdot Q0 \cdot \overline{UP})$$

$$CEO = TC \cdot CE$$

Design Entry Method

This design element is only for use in schematics.

For More Information

- See the [Spartan-3 Generation FPGA User Guide \(UG331\)](#).
- See the [Spartan-3E FPGA Family Data Sheet \(DS312\)](#).

CC16RE

Macro: 16-Bit Cascadable Binary Counter with Clock Enable and Synchronous Reset

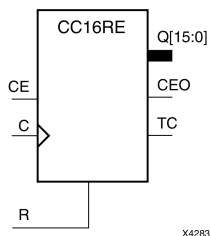

Introduction

This design element is a synchronous resettable, cascadable binary counter. These counters are implemented using carry logic with relative location constraints to ensure efficient logic placement. The synchronous reset (R) is the highest priority input. When R is High, all other inputs are ignored; the Q outputs, terminal count (TC), and clock enable out (CEO) go to logic level zero on the Low-to-High clock (C) transition. The Q outputs increment when the clock enable input (CE) is High during the Low-to-High clock transition. The counter ignores clock transitions when CE is Low. The TC output is High when all Q outputs and CE are High.

Create larger counters by connecting the CEO output of each stage to the CE input of the next stage and connecting the C and R inputs in parallel. CEO is active (High) when TC and CE are High. The maximum length of the counter is determined by the accumulated CE-to-TC propagation delays versus the clock period. The clock period must be greater than $n (t_{CE-TC})$, where n is the number of stages and the time t_{CE-TC} is the CE-to-TC propagation delay of each stage. When cascading counters, use the CEO output if the counter uses the CE input or use the TC output if it does not.

This counter is asynchronously cleared, outputs Low, when power is applied. For FPGA devices, power-on conditions are simulated when global set/reset (GSR) is active. GSR defaults to active-High but can be inverted by adding an inverter in front of the GSR input of the appropriate `STARTUP_architecture` symbol.

Logic Table

Inputs			Outputs		
R	CE	C	Qz-Q0	TC	CEO
1	X	↑	0	0	0
0	0	X	No change	No change	0
0	1	↑	Inc	TC	CEO

$z = \text{bit width} - 1$
 $TC = Qz \cdot Q(z-1) \cdot Q(z-2) \cdot \dots \cdot Q0$
 $CEO = TC \cdot CE$

Design Entry Method

This design element is only for use in schematics.

For More Information

- See the [Spartan-3 Generation FPGA User Guide \(UG331\)](#).
- See the [Spartan-3E FPGA Family Data Sheet \(DS312\)](#).

CC8CE

Macro: 8-Bit Cascadable Binary Counter with Clock Enable and Asynchronous Clear

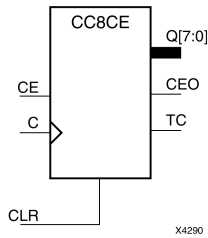

Introduction

This design element is an asynchronously clearable, cascadable binary counter. It is implemented using carry logic with relative location constraints to ensure efficient logic placement. The asynchronous clear (CLR) is the highest priority input. When CLR is High, all other inputs are ignored; the Q outputs, terminal count (TC), and clock enable out (CEO) go to logic level zero, independent of clock transitions. The Q outputs increment when the clock enable input (CE) is High during the Low-to-High clock (C) transition. The counter ignores clock transitions when CE is Low. The TC output is High when all Q outputs are High.

Create larger counters by connecting the CEO output of each stage to the CE input of the next stage and connecting the C and CLR inputs in parallel. CEO is active (High) when TC and CE are High. The maximum length of the counter is determined by the accumulated CE-to-TC propagation delays versus the clock period. The clock period must be greater than $n(t_{CE-TC})$, where n is the number of stages and the time t_{CE-TC} is the CE-to-TC propagation delay of each stage. When cascading counters, use the CEO output if the counter uses the CE input or use the TC output if it does not.

This counter is asynchronously cleared, outputs Low, when power is applied. For FPGA devices, power-on conditions are simulated when global set/reset (GSR) is active. GSR defaults to active-High but can be inverted by adding an inverter in front of the GSR input of the appropriate `STARTUP_architecture` symbol.

Logic Table

Inputs			Outputs		
CLR	CE	C	Qz-Q0	TC	CEO
1	X	X	0	0	0
0	0	X	No change	No change	0
0	1	↑	Inc	TC	CEO

z = bit width - 1
 $TC = Qz \cdot Q(z-1) \cdot Q(z-2) \cdot \dots \cdot Q0$
 $CEO = TC \cdot CE$

Design Entry Method

This design element is only for use in schematics.

For More Information

- See the [Spartan-3 Generation FPGA User Guide \(UG331\)](#).
- See the [Spartan-3E FPGA Family Data Sheet \(DS312\)](#).

CC8CLE

Macro: 8-Bit Loadable Cascadable Binary Counter with Clock Enable and Asynchronous Clear

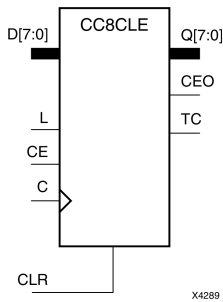

Introduction

This design element is a synchronously loadable, asynchronously clearable, cascadable binary counter. It is implemented using carry logic with relative location constraints to ensure efficient logic placement. The asynchronous clear (CLR) is the highest priority input. When CLR is High, all other inputs are ignored; the Q outputs, terminal count (TC), and clock enable out (CEO) go to logic level zero, independent of clock transitions. The data on the D inputs is loaded into the counter when the load enable input (L) is High during the Low-to-High clock (C) transition, independent of the state of clock enable (CE). The Q outputs increment when CE is High during the Low-to-High clock transition. The counter ignores clock transitions when CE is Low. The TC output is High when all Q outputs are High.

Create larger counters by connecting the CEO output of each stage to the CE input of the next stage and connecting the C, L, and CLR inputs in parallel. CEO is active (High) when TC and CE are High. The maximum length of the counter is determined by the accumulated CE-to-TC propagation delays versus the clock period. The clock period must be greater than $n(t_{CE-TC})$, where n is the number of stages and the time t_{CE-TC} is the CE-to-TC propagation delay of each stage. When cascading counters, use the CEO output if the counter uses the CE input or use the TC output if it does not.

This counter is asynchronously cleared, outputs Low, when power is applied. For FPGA devices, power-on conditions are simulated when global set/reset (GSR) is active. GSR defaults to active-High but can be inverted by adding an inverter in front of the GSR input of the appropriate `STARTUP_architecture` symbol.

Logic Table

Inputs					Outputs		
CLR	L	CE	C	Dz-D0	Qz-Q0	TC	CEO
1	X	X	X	X	0	0	0
0	1	X	↑	Dn	Dn	TC	CEO
0	0	0	X	X	No change	No change	0
0	0	1	↑	X	Inc	TC	CEO

z = bit width - 1
 $TC = Qz \cdot Q(z-1) \cdot Q(z-2) \cdot \dots \cdot Q0$
 $CEO = TC \cdot CE$

Design Entry Method

This design element is only for use in schematics.

For More Information

- See the [Spartan-3 Generation FPGA User Guide \(UG331\)](#).
- See the [Spartan-3E FPGA Family Data Sheet \(DS312\)](#).

CC8CLED

Macro: 8-Bit Loadable Cascadable Bidirectional Binary Counter with Clock Enable and Asynchronous Clear

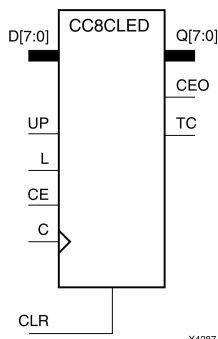

Introduction

This design element is a synchronously loadable, asynchronously clearable, cascadable, bidirectional binary counter. It is implemented using carry logic with relative location constraints, which assures most efficient logic placement. The asynchronous clear (CLR) is the highest priority input. When CLR is High, all other inputs are ignored; the Q outputs, terminal count (TC), and clock enable out (CEO) go to logic level zero, independent of clock transitions. The data on the D inputs is loaded into the counter when the load enable input (L) is High during the Low-to-High clock (C) transition, independent of the state of clock enable (CE). The Q outputs decrement when CE is High and UP is Low during the Low-to-High clock transition. The Q outputs increment when CE and UP are High. The counter ignores clock transitions when CE is Low.

For counting up, the TC output is High when all Q outputs and UP are High. For counting down, the TC output is High when all Q outputs and UP are Low.

Create larger counters by connecting the CEO output of each stage to the CE input of the next stage and connecting the C, UP, L, and CLR inputs in parallel. CEO is active (High) when TC and CE are High. The maximum length of the counter is determined by the accumulated CE-to-TC propagation delays versus the clock period. The clock period must be greater than $n (t_{CE-TC})$, where n is the number of stages and the time t_{CE-TC} is the CE-to-TC propagation delay of each stage. When cascading counters, use the CEO output if the counter uses the CE input or use the TC output if it does not.

This counter is asynchronously cleared, outputs Low, when power is applied. For FPGA devices, power-on conditions are simulated when global set/reset (GSR) is active. GSR defaults to active-High but can be inverted by adding an inverter in front of the GSR input of the appropriate `STARTUP_architecture` symbol.

Logic Table

Inputs						Outputs		
CLR	L	CE	C	UP	Dz-D0	Qz-Q0	TC	CEO
1	X	X	X	X	X	0	0	0
0	1	X	↑	X	Dn	Dn	TC	CEO
0	0	0	X	X	X	No change	No change	0
0	0	1	↑	1	X	Inc	TC	CEO
0	0	1	↑	0	X	Dec	TC	CEO

z = bit width - 1

$$TC = (Qz \cdot Q(z-1) \cdot Q(z-2) \cdot \dots \cdot Q0 \cdot UP) + (Qz \cdot Q(z-1) \cdot Q(z-2) \cdot \dots \cdot Q0 \cdot \overline{UP})$$

$$CEO = TC \cdot CE$$

Design Entry Method

This design element is only for use in schematics.

For More Information

- See the [Spartan-3 Generation FPGA User Guide \(UG331\)](#).
- See the [Spartan-3E FPGA Family Data Sheet \(DS312\)](#).

CC8RE

Macro: 8-Bit Cascadable Binary Counter with Clock Enable and Synchronous Reset

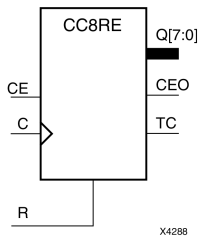

Introduction

This design element is a synchronous resettable, cascadable binary counter. These counters are implemented using carry logic with relative location constraints to ensure efficient logic placement. The synchronous reset (R) is the highest priority input. When R is High, all other inputs are ignored; the Q outputs, terminal count (TC), and clock enable out (CEO) go to logic level zero on the Low-to-High clock (C) transition. The Q outputs increment when the clock enable input (CE) is High during the Low-to-High clock transition. The counter ignores clock transitions when CE is Low. The TC output is High when all Q outputs and CE are High.

Create larger counters by connecting the CEO output of each stage to the CE input of the next stage and connecting the C and R inputs in parallel. CEO is active (High) when TC and CE are High. The maximum length of the counter is determined by the accumulated CE-to-TC propagation delays versus the clock period. The clock period must be greater than $n (t_{CE-TC})$, where n is the number of stages and the time t_{CE-TC} is the CE-to-TC propagation delay of each stage. When cascading counters, use the CEO output if the counter uses the CE input or use the TC output if it does not.

This counter is asynchronously cleared, outputs Low, when power is applied. For FPGA devices, power-on conditions are simulated when global set/reset (GSR) is active. GSR defaults to active-High but can be inverted by adding an inverter in front of the GSR input of the appropriate `STARTUP_architecture` symbol.

Logic Table

Inputs			Outputs		
R	CE	C	Qz-Q0	TC	CEO
1	X	↑	0	0	0
0	0	X	No change	No change	0
0	1	↑	Inc	TC	CEO

$z = \text{bit width} - 1$
 $TC = Qz \cdot Q(z-1) \cdot Q(z-2) \cdot \dots \cdot Q0$
 $CEO = TC \cdot CE$

Design Entry Method

This design element is only for use in schematics.

For More Information

- See the [Spartan-3 Generation FPGA User Guide \(UG331\)](#).
- See the [Spartan-3E FPGA Family Data Sheet \(DS312\)](#).

CD4CE

Macro: 4-Bit Cascadable BCD Counter with Clock Enable and Asynchronous Clear

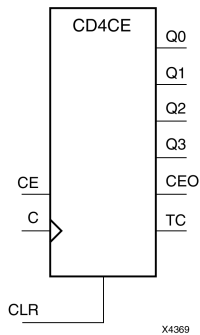

Introduction

CD4CE is a 4-bit (stage), asynchronous clearable, cascadable binary-coded-decimal (BCD) counter. The asynchronous clear input (CLR) is the highest priority input. When CLR is High, all other inputs are ignored; the Q outputs, terminal count (TC), and clock enable out (CEO) go to logic level zero, independent of clock transitions. The Q outputs increment when clock enable (CE) is High during the Low-to-High clock (C) transition. The counter ignores clock transitions when CE is Low. The TC output is High when Q3 and Q0 are High and Q2 and Q1 are Low.

The counter recovers from any of six possible illegal states and returns to a normal count sequence within two clock cycles for Xilinx® devices, as shown in the following state diagram:

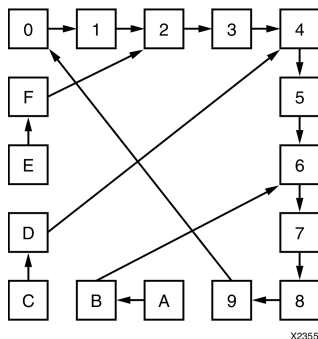

Create larger counters by connecting the CEO output of each stage to the CE input of the next stage and connecting the C and CLR inputs in parallel. CEO is active (High) when TC and CE are High. The maximum length of the counter is determined by the accumulated CE-to-TC propagation delays versus the clock period. The clock period must be greater than $n(t_{CE-TC})$, where n is the number of stages and the time t_{CE-TC} is the CE-to-TC propagation delay of each stage. When cascading counters, use the CEO output if the counter uses the CE input or use the TC output if it does not.

This counter is asynchronously cleared, outputs Low, when power is applied. For FPGA devices, power-on conditions are simulated when global set/reset (GSR) is active. GSR defaults to active-High but can be inverted by adding an inverter in front of the GSR input of the appropriate `STARTUP_architecture` symbol.

Logic Table

Inputs			Outputs					
CLR	CE	C	Q3	Q2	Q1	Q0	TC	CEO
1	X	X	0	0	0	0	0	0
0	1	↑	Inc	Inc	Inc	Inc	TC	CEO
0	0	X	No Change	No Change	No Change	No Change	TC	0
0	1	X	1	0	0	1	1	1

TC = $Q3 \cdot !Q2 \cdot !Q1 \cdot Q0$
 CEO = $TC \cdot CE$

Design Entry Method

This design element is only for use in schematics.

For More Information

- See the [Spartan-3 Generation FPGA User Guide \(UG331\)](#).
- See the [Spartan-3E FPGA Family Data Sheet \(DS312\)](#).

CD4CLE

Macro: 4-Bit Loadable Cascadable BCD Counter with Clock Enable and Asynchronous Clear

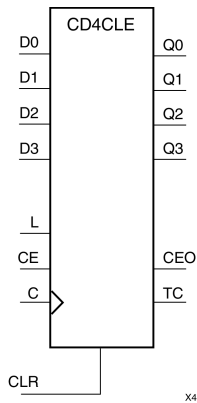

Introduction

CD4CLE is a 4-bit (stage), synchronously loadable, asynchronously clearable, binarycoded- decimal (BCD) counter. The asynchronous clear input (CLR) is the highest priority input. When (CLR) is High, all other inputs are ignored; the (Q) outputs, terminal count (TC), and clock enable out (CEO) go to logic level zero, independent of clock transitions. The data on the (D) inputs is loaded into the counter when the load enable input (L) is High during the Low-to-High clock (C) transition. The (Q) outputs increment when clock enable input (CE) is High during the Low- to-High clock transition. The counter ignores clock transitions when (CE) is Low. The (TC) output is High when Q3 and Q0 are High and Q2 and Q1 are Low.

The counter recovers from any of six possible illegal states and returns to a normal count sequence within two clock cycles for Xilinx® devices, as shown in the following state diagram:

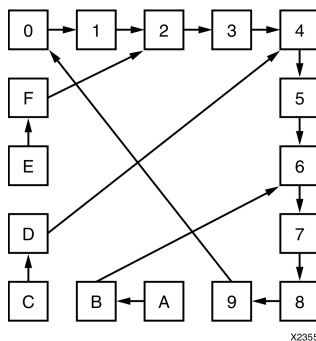

Create larger counters by connecting the CEO output of each stage to the CE input of the next stage and connecting the C, L, and CLR inputs in parallel. CEO is active (High) when TC and CE are High. The maximum length of the counter is determined by the accumulated CE-to-TC propagation delays versus the clock period. The clock period must be greater than $n(t_{CE-TC})$, where n is the number of stages and the time t_{CE-TC} is the CE-to-TC propagation delay of each stage. When cascading counters, use the CEO output if the counter uses the CE input or use the TC output if it does not.

This counter is asynchronously cleared, outputs Low, when power is applied. For FPGA devices, power-on conditions are simulated when global set/reset (GSR) is active. GSR defaults to active-High but can be inverted by adding an inverter in front of the GSR input of the appropriate `STARTUP_architecture` symbol.

Logic Table

Inputs					Outputs					
CLR	L	CE	D3 : D0	C	Q3	Q2	Q1	Q0	TC	CEO
1	X	X	X	X	0	0	0	0	0	0
0	1	X	D3 : D0	↑	D3	D2	D1	D0	TC	CEO
0	0	1	X	↑	Inc	Inc	Inc	Inc	TC	CEO
0	0	0	X	X	No Change	No Change	No Change	No Change	TC	0
0	0	1	X	X	1	0	0	1	1	1

TC = Q3•!Q2•!Q1•Q0
CEO = TC•CE

Design Entry Method

This design element is only for use in schematics.

For More Information

- See the [Spartan-3 Generation FPGA User Guide \(UG331\)](#).
- See the [Spartan-3E FPGA Family Data Sheet \(DS312\)](#).

CD4RE

Macro: 4-Bit Cascadable BCD Counter with Clock Enable and Synchronous Reset

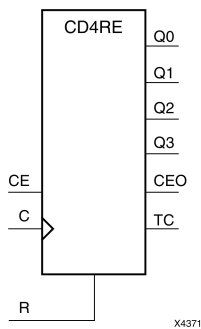

Introduction

CD4RE is a 4-bit (stage), synchronous resettable, cascadable binary-coded-decimal (BCD) counter. The synchronous reset input (R) is the highest priority input. When (R) is High, all other inputs are ignored; the (Q) outputs, terminal count (TC), and clock enable out (CEO) go to logic level zero on the Low-to-High clock (C) transition. The (Q) outputs increment when the clock enable input (CE) is High during the Low-to-High clock transition. The counter ignores clock transitions when (CE) is Low. The (TC) output is High when Q3 and Q0 are High and Q2 and Q1 are Low.

The counter recovers from any of six possible illegal states and returns to a normal count sequence within two clock cycles for Xilinx® devices, as shown in the following state diagram:

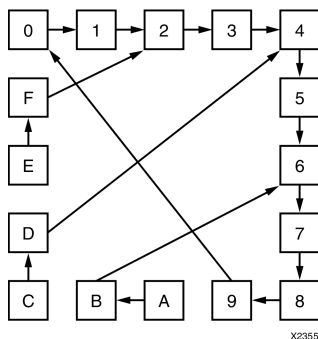

Create larger counters by connecting the CEO output of each stage to the CE input of the next stage and connecting the C and R inputs in parallel. CEO is active (High) when TC and CE are High. The maximum length of the counter is determined by the accumulated CE-to-TC propagation delays versus the clock period. The clock period must be greater than $n (t_{CE-TC})$, where n is the number of stages and the time t_{CE-TC} is the CE-to-TC propagation delay of each stage. When cascading counters, use the CEO output if the counter uses the CE input or use the TC output if it does not.

This counter is asynchronously cleared, outputs Low, when power is applied. For FPGA devices, power-on conditions are simulated when global set/reset (GSR) is active. GSR defaults to active-High but can be inverted by adding an inverter in front of the GSR input of the appropriate STARTUP_architecture symbol.

Logic Table

Inputs			Outputs					
R	CE	C	Q3	Q2	Q1	Q0	TC	CEO
1	X	↑	0	0	0	0	0	0
0	1	↑	Inc	Inc	Inc	Inc	TC	CEO
0	0	X	No Change	No Change	No Change	No Change	TC	0
0	1	X	1	0	0	1	1	1

$TC = Q3 \cdot !Q2 \cdot !Q1 \cdot Q0$
 $CEO = TC \cdot CE$

Design Entry Method

This design element is only for use in schematics.

For More Information

- See the [Spartan-3 Generation FPGA User Guide \(UG331\)](#).
- See the [Spartan-3E FPGA Family Data Sheet \(DS312\)](#).

CD4RLE

Macro: 4-Bit Loadable Cascadable BCD Counter with Clock Enable and Synchronous Reset

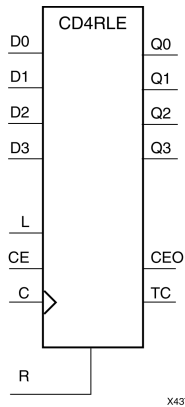

Introduction

CD4RLE is a 4-bit (stage), synchronous loadable, resettable, binary-coded-decimal (BCD) counter. The synchronous reset input (R) is the highest priority input. When R is High, all other inputs are ignored; the Q outputs, terminal count (TC), and clock enable out (CEO) go to logic level zero on the Low-to-High clock transitions. The data on the D inputs is loaded into the counter when the load enable input (L) is High during the Low-to-High clock (C) transition. The Q outputs increment when the clock enable input (CE) is High during the Low-to-High clock transition. The counter ignores clock transitions when CE is Low. The TC output is High when Q3 and Q0 are High and Q2 and Q1 are Low.

The counter recovers from any of six possible illegal states and returns to a normal count sequence within two clock cycles for Xilinx® devices, as shown in the following state diagram:

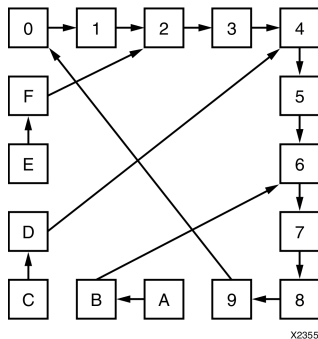

Create larger counters by connecting the CEO output of each stage to the CE input of the next stage and connecting the C, L, and R inputs in parallel. CEO is active (High) when TC and CE are High. The maximum length of the counter is determined by the accumulated CE-to-TC propagation delays versus the clock period. The clock period must be greater than $n(t_{CE-TC})$, where n is the number of stages and the time t_{CE-TC} is the CE-to-TC propagation delay of each stage. When cascading counters, use the CEO output if the counter uses the CE input or use the TC output if it does not.

This counter is asynchronously cleared, outputs Low, when power is applied. For FPGA devices, power-on conditions are simulated when global set/reset (GSR) is active. GSR defaults to active-High but can be inverted by adding an inverter in front of the GSR input of the appropriate `STARTUP_architecture` symbol.

Logic Table

Inputs					Outputs					
R	L	CE	D3 : D0	C	Q3	Q2	Q1	Q0	TC	CEO
1	X	X	X	↑	0	0	0	0	0	0
0	1	X	D3 : D0	↑	D3	D	D	D0	TC	CEO
0	0	1	X	↑	Inc	Inc	Inc	Inc	TC	CEO
0	0	0	X	X	No Change	No Change	No Change	No Change	TC	0
0	0	1	X	X	1	0	0	1	1	1

$TC = Q3 \cdot !Q2 \cdot !Q1 \cdot Q0$
 $CEO = TC \cdot CE$

Design Entry Method

This design element is only for use in schematics.

For More Information

- See the [Spartan-3 Generation FPGA User Guide \(UG331\)](#).
- See the [Spartan-3E FPGA Family Data Sheet \(DS312\)](#).

CJ4CE

Macro: 4-Bit Johnson Counter with Clock Enable and Asynchronous Clear

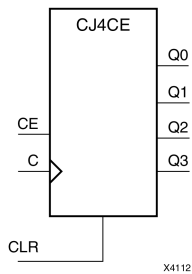

Introduction

This design element is a clearable Johnson/shift counter. The asynchronous clear (CLR) input, when High, overrides all other inputs and forces the data (Q) outputs to logic level zero, independent of clock (C) transitions. The counter increments (shifts Q0 to Q1, Q1 to Q2, and so forth) when the clock enable input (CE) is High during the Low-to-High clock transition. Clock transitions are ignored when (CE) is Low.

The Q3 output is inverted and fed back to input Q0 to provide continuous counting operation.

This counter is asynchronously cleared, outputs Low, when power is applied. For FPGA devices, power-on conditions are simulated when global set/reset (GSR) is active. GSR defaults to active-High but can be inverted by adding an inverter in front of the GSR input of the appropriate STARTUP_architecture symbol.

Logic Table

Inputs			Outputs	
CLR	CE	C	Q0	Q1 through Q3
1	X	X	0	0
0	0	X	No change	No change
0	1	↑	!q3	q0 through q2

q = state of referenced output one setup time prior to active clock transition

Design Entry Method

This design element is only for use in schematics.

For More Information

- See the [Spartan-3 Generation FPGA User Guide \(UG331\)](#).
- See the [Spartan-3E FPGA Family Data Sheet \(DS312\)](#).

CJ4RE

Macro: 4-Bit Johnson Counter with Clock Enable and Synchronous Reset

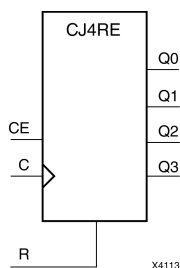

Introduction

This design element is a resettable Johnson/shift counter. The synchronous reset (R) input, when High, overrides all other inputs and forces the data (Q) outputs to logic level zero during the Low-to-High clock (C) transition. The counter increments (shifts Q0 to Q1, Q1 to Q2, and so forth) when the clock enable input (CE) is High during the Low-to-High clock transition. Clock transitions are ignored when CE is Low.

The Q3 output is inverted and fed back to input Q0 to provide continuous counting operation.

This counter is asynchronously cleared, outputs Low, when power is applied. For FPGA devices, power-on conditions are simulated when global set/reset (GSR) is active. GSR defaults to active-High but can be inverted by adding an inverter in front of the GSR input of the appropriate `STARTUP_architecture` symbol.

Logic Table

Inputs			Outputs	
R	CE	C	Q0	Q1 through Q3
1	X	↑	0	0
0	0	X	No change	No change
0	1	↑	!q3	q0 through q2

q = state of referenced output one setup time prior to active clock transition

Design Entry Method

This design element is only for use in schematics.

For More Information

- See the [Spartan-3 Generation FPGA User Guide \(UG331\)](#).
- See the [Spartan-3E FPGA Family Data Sheet \(DS312\)](#).

CJ5CE

Macro: 5-Bit Johnson Counter with Clock Enable and Asynchronous Clear

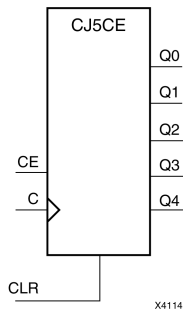

Introduction

This design element is a clearable Johnson/shift counter. The asynchronous clear (CLR) input, when High, overrides all other inputs and forces the data (Q) outputs to logic level zero, independent of clock (C) transitions. The counter increments (shifts Q0 to Q1, Q1 to Q2, and so forth) when the clock enable input (CE) is High during the Low-to-High clock transition. Clock transitions are ignored when (CE) is Low.

The Q4 output is inverted and fed back to input Q0 to provide continuous counting operation.

This counter is asynchronously cleared, outputs Low, when power is applied. For FPGA devices, power-on conditions are simulated when global set/reset (GSR) is active. GSR defaults to active-High but can be inverted by adding an inverter in front of the GSR input of the appropriate *STARTUP_architecture* symbol.

Logic Table

Inputs			Outputs	
CLR	CE	C	Q0	Q1 through Q4
1	X	X	0	0
0	0	X	No change	No change
0	1	↑	!q4	q0 through q3

q = state of referenced output one setup time prior to active clock transition

Design Entry Method

This design element is only for use in schematics.

For More Information

- See the [Spartan-3 Generation FPGA User Guide \(UG331\)](#).
- See the [Spartan-3E FPGA Family Data Sheet \(DS312\)](#).

CJ5RE

Macro: 5-Bit Johnson Counter with Clock Enable and Synchronous Reset

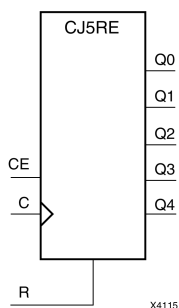

Introduction

This design element is a resettable Johnson/shift counter. The synchronous reset (R) input, when High, overrides all other inputs and forces the data (Q) outputs to logic level zero during the Low-to-High clock (C) transition. The counter increments (shifts Q0 to Q1, Q1 to Q2, and so forth) when the clock enable input (CE) is High during the Low-to-High clock transition. Clock transitions are ignored when CE is Low.

The Q4 output is inverted and fed back to input Q0 to provide continuous counting operation.

This counter is asynchronously cleared, outputs Low, when power is applied. For FPGA devices, power-on conditions are simulated when global set/reset (GSR) is active. GSR defaults to active-High but can be inverted by adding an inverter in front of the GSR input of the appropriate `STARTUP_architecture` symbol.

Logic Table

Inputs			Outputs	
R	CE	C	Q0	Q1 through Q4
1	X	↑	0	0
0	0	X	No change	No change
0	1	↑	!q4	q0 through q3

q = state of referenced output one setup time prior to active clock transition

Design Entry Method

This design element is only for use in schematics.

For More Information

- See the [Spartan-3 Generation FPGA User Guide \(UG331\)](#).
- See the [Spartan-3E FPGA Family Data Sheet \(DS312\)](#).

CJ8CE

Macro: 8-Bit Johnson Counter with Clock Enable and Asynchronous Clear

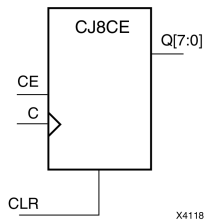

Introduction

This design element is a clearable Johnson/shift counter. The asynchronous clear (CLR) input, when High, overrides all other inputs and forces the data (Q) outputs to logic level zero, independent of clock (C) transitions. The counter increments (shifts Q0 to Q1, Q1 to Q2, and so forth) when the clock enable input (CE) is High during the Low-to-High clock transition. Clock transitions are ignored when (CE) is Low.

The Q7 output is inverted and fed back to input Q0 to provide continuous counting operation.

This counter is asynchronously cleared, outputs Low, when power is applied. For FPGA devices, power-on conditions are simulated when global set/reset (GSR) is active. GSR defaults to active-High but can be inverted by adding an inverter in front of the GSR input of the appropriate `STARTUP_architecture` symbol.

Logic Table

Inputs			Outputs	
CLR	CE	C	Q0	Q1 through Q8
1	X	X	0	0
0	0	X	No change	No change
0	1	↑	!q7	q0 through q7

q = state of referenced output one setup time prior to active clock transition

Design Entry Method

This design element is only for use in schematics.

For More Information

- See the [Spartan-3 Generation FPGA User Guide \(UG331\)](#).
- See the [Spartan-3E FPGA Family Data Sheet \(DS312\)](#).

CJ8RE

Macro: 8-Bit Johnson Counter with Clock Enable and Synchronous Reset

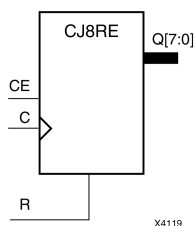

Introduction

This design element is a resettable Johnson/shift counter. The synchronous reset (R) input, when High, overrides all other inputs and forces the data (Q) outputs to logic level zero during the Low-to-High clock (C) transition. The counter increments (shifts Q0 to Q1, Q1 to Q2, and so forth) when the clock enable input (CE) is High during the Low-to-High clock transition. Clock transitions are ignored when CE is Low.

The Q7 output is inverted and fed back to input Q0 to provide continuous counting operation.

This counter is asynchronously cleared, outputs Low, when power is applied. For FPGA devices, power-on conditions are simulated when global set/reset (GSR) is active. GSR defaults to active-High but can be inverted by adding an inverter in front of the GSR input of the appropriate `STARTUP_architecture` symbol.

Logic Table

Inputs			Outputs	
R	CE	C	Q0	Q1 through Q7
1	X	↑	0	0
0	0	X	No change	No change
0	1	↑	!q7	q0 through q6

q = state of referenced output one setup time prior to active clock transition

Design Entry Method

This design element is only for use in schematics.

For More Information

- See the [Spartan-3 Generation FPGA User Guide \(UG331\)](#).
- See the [Spartan-3E FPGA Family Data Sheet \(DS312\)](#).

COMP16

Macro: 16-Bit Identity Comparator

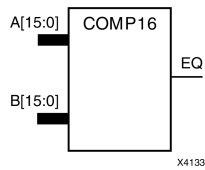

Introduction

This design element is a 16-bit identity comparator. The equal output (EQ) is high when A15 : A0 and B15 : B0 are equal.

Equality is determined by a bit comparison of the two words. When any two of the corresponding bits from each word are not the same, the EQ output is Low.

Design Entry Method

This design element is only for use in schematics.

For More Information

- See the [Spartan-3 Generation FPGA User Guide \(UG331\)](#).
- See the [Spartan-3E FPGA Family Data Sheet \(DS312\)](#).

COMP2

Macro: 2-Bit Identity Comparator

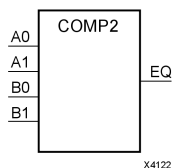

Introduction

This design element is a 2-bit identity comparator. The equal output (EQ) is High when the two words A1 : A0 and B1 : B0 are equal.

Equality is determined by a bit comparison of the two words. When any two of the corresponding bits from each word are not the same, the EQ output is Low.

Design Entry Method

This design element is only for use in schematics.

For More Information

- See the [Spartan-3 Generation FPGA User Guide \(UG331\)](#).
- See the [Spartan-3E FPGA Family Data Sheet \(DS312\)](#).

COMP4

Macro: 4-Bit Identity Comparator

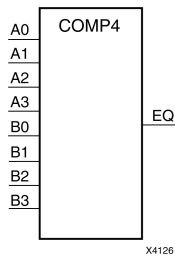

Introduction

This design element is a 4-bit identity comparator. The equal output (EQ) is high when A3 : A0 and B3 : B0 are equal.

Equality is determined by a bit comparison of the two words. When any two of the corresponding bits from each word are not the same, the EQ output is Low.

Design Entry Method

This design element is only for use in schematics.

For More Information

- See the [Spartan-3 Generation FPGA User Guide \(UG331\)](#).
- See the [Spartan-3E FPGA Family Data Sheet \(DS312\)](#).

COMP8

Macro: 8-Bit Identity Comparator

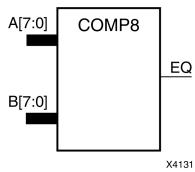

Introduction

This design element is an 8-bit identity comparator. The equal output (EQ) is high when A7 : A0 and B7 : B0 are equal.

Equality is determined by a bit comparison of the two words. When any two of the corresponding bits from each word are not the same, the EQ output is Low.

Design Entry Method

This design element is only for use in schematics.

For More Information

- See the [Spartan-3 Generation FPGA User Guide \(UG331\)](#).
- See the [Spartan-3E FPGA Family Data Sheet \(DS312\)](#).

COMP16

Macro: 16-Bit Magnitude Comparator

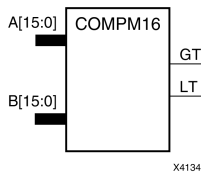

Introduction

This design element is a 16-bit magnitude comparator that compare two positive Binary-weighted words. It compares A15 : A0 and B15 : B0, where A15 and B15 are the most significant bits.

The greater-than output (GT) is High when A > B, and the less-than output (LT) is High when A < B. When the two words are equal, both GT and LT are Low. Equality can be measured with this macro by comparing both outputs with a NOR gate.

Logic Table

Inputs								Outputs	
A7, B7	A6, B6	A5, B5	A4, B4	A3, B3	A2, B2	A1, B1	A0, B0	GT	LT
A7>B7	X	X	X	X	X	X	X	1	0
A7<B7	X	X	X	X	X	X	X	0	1
A7=B7	A6>B6	X	X	X	X	X	X	1	0
A7=B7	A6<B6	X	X	X	X	X	X	0	1
A7=B7	A6=B6	A5>B5	X	X	X	X	X	1	0
A7=B7	A6=B6	A5<B5	X	X	X	X	X	0	1
A7=B7	A6=B6	A5=B5	A4>B4	X	X	X	X	1	0
A7=B7	A6=B6	A5=B5	A4<B4	X	X	X	X	0	1
A7=B7	A6=B6	A5=B5	A4=B4	A3>B3	X	X	X	1	0
A7=B7	A6=B6	A5=B5	A4=B4	A3<B3	X	X	X	0	1
A7=B7	A6=B6	A5=B5	A4=B4	A3=B3	A2>B2	X	X	1	0
A7=B7	A6=B6	A5=B5	A4=B4	A3=B3	A2<B2	X	X	0	1
A7=B7	A6=B6	A5=B5	A4=B4	A3=B3	A2=B2	A1>B1	X	1	0
A7=B7	A6=B6	A5=B5	A4=B4	A3=B3	A2=B2	A1<B1	X	0	1
A7=B7	A6=B6	A5=B5	A4=B4	A3=B3	A2=B2	A1=B1	A0>B0	1	0
A7=B7	A6=B6	A5=B5	A4=B4	A3=B3	A2=B2	A1=B1	A0<B0	0	1
A7=B7	A6=B6	A5=B5	A4=B4	A3=B3	A2=B2	A1=B1	A0=B0	0	0

Design Entry Method

This design element is only for use in schematics.

For More Information

- See the [Spartan-3 Generation FPGA User Guide \(UG331\)](#).
- See the [Spartan-3E FPGA Family Data Sheet \(DS312\)](#).

COMPM2

Macro: 2-Bit Magnitude Comparator

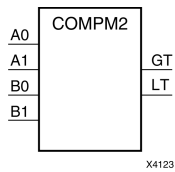

Introduction

This design element is a 2-bit magnitude comparator that compares two positive binary-weighted words. It compares A1 : A0 and B1 : B0, where A1 and B1 are the most significant bits.

The greater-than output (GT) is High when $A > B$, and the less-than output (LT) is High when $A < B$. When the two words are equal, both GT and LT are Low. Equality can be measured with this macro by comparing both outputs with a NOR gate.

Logic Table

Inputs				Outputs	
A1	B1	A0	B0	GT	LT
0	0	0	0	0	0
0	0	1	0	1	0
0	0	0	1	0	1
0	0	1	1	0	0
1	1	0	0	0	0
1	1	1	0	1	0
1	1	0	1	0	1
1	1	1	1	0	0
1	0	X	X	1	0
0	1	X	X	0	1

Design Entry Method

This design element is only for use in schematics.

For More Information

- See the [Spartan-3 Generation FPGA User Guide \(UG331\)](#).
- See the [Spartan-3E FPGA Family Data Sheet \(DS312\)](#).

COMPM4

Macro: 4-Bit Magnitude Comparator

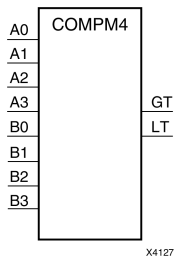

Introduction

This design element is a 4-bit magnitude comparator that compare two positive Binary-weighted words. It compares A3 : A0 and B3 : B0, where A3 and B3 are the most significant bits.

The greater-than output (GT) is High when $A > B$, and the less-than output (LT) is High when $A < B$. When the two words are equal, both GT and LT are Low. Equality can be measured with this macro by comparing both outputs with a NOR gate.

Logic Table

Inputs				Outputs	
A3, B3	A2, B2	A1, B1	A0, B0	GT	LT
A3>B3	X	X	X	1	0
A3<B3	X	X	X	0	1
A3=B3	A2>B2	X	X	1	0
A3=B3	A2<B2	X	X	0	1
A3=B3	A2=B2	A1>B1	X	1	0
A3=B3	A2=B2	A1<B1	X	0	1
A3=B3	A2=A2	A1=B1	A0>B0	1	0
A3=B3	A2=B2	A1=B1	A0<B0	0	1
A3=B3	A2=B2	A1=B1	A0=B0	0	0

Design Entry Method

This design element is only for use in schematics.

For More Information

- See the [Spartan-3 Generation FPGA User Guide \(UG331\)](#).
- See the [Spartan-3E FPGA Family Data Sheet \(DS312\)](#).

COMP8

Macro: 8-Bit Magnitude Comparator

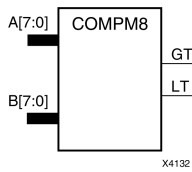

Introduction

This design element is an 8-bit magnitude comparator that compare two positive Binary-weighted words. It compares A7 : A0 and B7 : B0, where A7 and B7 are the most significant bits.

The greater-than output (GT) is High when A > B, and the less-than output (LT) is High when A < B. When the two words are equal, both GT and LT are Low. Equality can be measured with this macro by comparing both outputs with a NOR gate.

Logic Table

Inputs								Outputs	
A7, B7	A6, B6	A5, B5	A4, B4	A3, B3	A2, B2	A1, B1	A0, B0	GT	LT
A7>B7	X	X	X	X	X	X	X	1	0
A7<B7	X	X	X	X	X	X	X	0	1
A7=B7	A6>B6	X	X	X	X	X	X	1	0
A7=B7	A6<B6	X	X	X	X	X	X	0	1
A7=B7	A6=B6	A5>B5	X	X	X	X	X	1	0
A7=B7	A6=B6	A5<B5	X	X	X	X	X	0	1
A7=B7	A6=B6	A5=B5	A4>B4	X	X	X	X	1	0
A7=B7	A6=B6	A5=B5	A4<B4	X	X	X	X	0	1
A7=B7	A6=B6	A5=B5	A4=B4	A3>B3	X	X	X	1	0
A7=B7	A6=B6	A5=B5	A4=B4	A3<B3	X	X	X	0	1
A7=B7	A6=B6	A5=B5	A4=B4	A3=B3	A2>B2	X	X	1	0
A7=B7	A6=B6	A5=B5	A4=B4	A3=B3	A2<B2	X	X	0	1
A7=B7	A6=B6	A5=B5	A4=B4	A3=B3	A2=B2	A1>B1	X	1	0
A7=B7	A6=B6	A5=B5	A4=B4	A3=B3	A2=B2	A1<B1	X	0	1
A7=B7	A6=B6	A5=B5	A4=B4	A3=B3	A2=B2	A1=B1	A0>B0	1	0
A7=B7	A6=B6	A5=B5	A4=B4	A3=B3	A2=B2	A1=B1	A0<B0	0	1
A7=B7	A6=B6	A5=B5	A4=B4	A3=B3	A2=B2	A1=B1	A0=B0	0	0

Design Entry Method

This design element is only for use in schematics.

For More Information

- See the [Spartan-3 Generation FPGA User Guide \(UG331\)](#).
- See the [Spartan-3E FPGA Family Data Sheet \(DS312\)](#).

COMP16

Macro: 16-Bit Magnitude Comparator

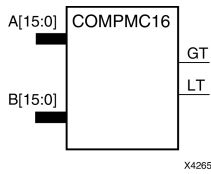

Introduction

This design element is a 16-bit, magnitude comparator that compares two positive Binary weighted words A15 : A0 and B15 : B0, where A15 and B15 are the most significant bits.

This comparator is implemented using carry logic with relative location constraints to ensure efficient logic placement.

The greater-than output (GT) is High when $A > B$, and the less-than output (LT) is High when $A < B$. When the two words are equal, both GT and LT are Low. Equality can be flagged with this macro by connecting both outputs to a NOR gate.

Logic Table

Inputs								Outputs	
A7, B7	A6, B6	A5, B5	A4, B4	A3, B3	A2, B2	A1, B1	A0, B0	GT	LT
A7>B7	X	X	X	X	X	X	X	1	0
A7<B7	X	X	X	X	X	X	X	0	1
A7=B7	A6>B6	X	X	X	X	X	X	1	0
A7=B7	A6<B6	X	X	X	X	X	X	0	1
A7=B7	A6=B6	A5>B5	X	X	X	X	X	1	0
A7=B7	A6=B6	A5<B5	X	X	X	X	X	0	1
A7=B7	A6=B6	A5=B5	A4>B4	X	X	X	X	1	0
A7=B7	A6=B6	A5=B5	A4<B4	X	X	X	X	0	1
A7=B7	A6=B6	A5=B5	A4=B4	A3>B3	X	X	X	1	0
A7=B7	A6=B6	A5=B5	A4=B4	A3<B3	X	X	X	0	1
A7=B7	A6=B6	A5=B5	A4=B4	A3=B3	A2>B2	X	X	1	0
A7=B7	A6=B6	A5=B5	A4=B4	A3=B3	A2<B2	X	X	0	1
A7=B7	A6=B6	A5=B5	A4=B4	A3=B3	A2=B2	A1>B1	X	1	0
A7=B7	A6=B6	A5=B5	A4=B4	A3=B3	A2=B2	A1<B1	X	0	1
A7=B7	A6=B6	A5=B5	A4=B4	A3=B3	A2=B2	A1=B1	A0>B0	1	0
A7=B7	A6=B6	A5=B5	A4=B4	A3=B3	A2=B2	A1=B1	A0<B0	0	1
A7=B7	A6=B6	A5=B5	A4=B4	A3=B3	A2=B2	A1=B1	A0=B0	0	0

Design Entry Method

This design element is only for use in schematics.

For More Information

- See the [Spartan-3 Generation FPGA User Guide \(UG331\)](#).
- See the [Spartan-3E FPGA Family Data Sheet \(DS312\)](#).

COMP8

Macro: 8-Bit Magnitude Comparator

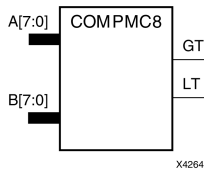

Introduction

This design element is an 8-bit, magnitude comparator that compares two positive Binaryweighted words A7 : A0 and B7 : B0, where A7 and B7 are the most significant bits.

This comparator is implemented using carry logic with relative location constraints to ensure efficient logic placement.

The greater-than output (GT) is High when A>B, and the less-than output (LT) is High when A<B. When the two words are equal, both GT and LT are Low. Equality can be flagged with this macro by connecting both outputs to a NOR gate.

Logic Table

Inputs								Outputs	
A7, B7	A6, B6	A5, B5	A4, B4	A3, B3	A2, B2	A1, B1	A0, B0	GT	LT
A7>B7	X	X	X	X	X	X	X	1	0
A7<B7	X	X	X	X	X	X	X	0	1
A7=B7	A6>B6	X	X	X	X	X	X	1	0
A7=B7	A6<B6	X	X	X	X	X	X	0	1
A7=B7	A6=B6	A5>B5	X	X	X	X	X	1	0
A7=B7	A6=B6	A5<B5	X	X	X	X	X	0	1
A7=B7	A6=B6	A5=B5	A4>B4	X	X	X	X	1	0
A7=B7	A6=B6	A5=B5	A4<B4	X	X	X	X	0	1
A7=B7	A6=B6	A5=B5	A4=B4	A3>B3	X	X	X	1	0
A7=B7	A6=B6	A5=B5	A4=B4	A3<B3	X	X	X	0	1
A7=B7	A6=B6	A5=B5	A4=B4	A3=B3	A2>B2	X	X	1	0
A7=B7	A6=B6	A5=B5	A4=B4	A3=B3	A2<B2	X	X	0	1
A7=B7	A6=B6	A5=B5	A4=B4	A3=B3	A2=B2	A1>B1	X	1	0
A7=B7	A6=B6	A5=B5	A4=B4	A3=B3	A2=B2	A1<B1	X	0	1
A7=B7	A6=B6	A5=B5	A4=B4	A3=B3	A2=B2	A1=B1	A0>B0	1	0
A7=B7	A6=B6	A5=B5	A4=B4	A3=B3	A2=B2	A1=B1	A0<B0	0	1
A7=B7	A6=B6	A5=B5	A4=B4	A3=B3	A2=B2	A1=B1	A0=B0	0	0

Design Entry Method

This design element is only for use in schematics.

For More Information

- See the [Spartan-3 Generation FPGA User Guide \(UG331\)](#).
- See the [Spartan-3E FPGA Family Data Sheet \(DS312\)](#).

CR16CE

Macro: 16-Bit Negative-Edge Binary Ripple Counter with Clock Enable and Asynchronous Clear

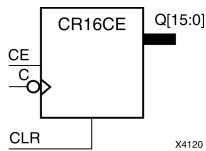

Introduction

This design element is a 16-bit cascadable, clearable, binary ripple counter with clock enable and asynchronous clear.

Larger counters can be created by connecting the last Q output of the first stage to the clock input of the next stage. CLR and CE inputs are connected in parallel. The clock period is not affected by the overall length of a ripple counter. The overall clock-to-output propagation is $n(t_{c-Q})$, where n is the number of stages and the time t_{c-Q} is the C-to-Qz propagation delay of each stage.

This counter is asynchronously cleared, outputs Low, when power is applied. For FPGA devices, power-on conditions are simulated when global set/reset (GSR) is active. GSR defaults to active-High but can be inverted by adding an inverter in front of the GSR input of the appropriate `STARTUP_architecture` symbol.

Logic Table

Inputs			Outputs
CLR	CE	C	Qz : Q0
1	X	X	0
0	0	X	No Change
0	1	↓	Inc

z = bit width - 1

Design Entry Method

This design element is only for use in schematics.

For More Information

- See the [Spartan-3 Generation FPGA User Guide \(UG331\)](#).
- See the [Spartan-3E FPGA Family Data Sheet \(DS312\)](#).

CR8CE

Macro: 8-Bit Negative-Edge Binary Ripple Counter with Clock Enable and Asynchronous Clear

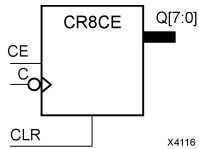

Introduction

This design element is an 8-bit cascadable, clearable, binary, ripple counter with clock enable and asynchronous clear.

The asynchronous clear (CLR), when High, overrides all other inputs and causes the Q outputs to go to logic level zero. The counter increments when the clock enable input (CE) is High during the High-to-Low clock (C) transition. The counter ignores clock transitions when CE is Low.

Larger counters can be created by connecting the last Q output of the first stage to the clock input of the next stage. CLR and CE inputs are connected in parallel. The clock period is not affected by the overall length of a ripple counter. The overall clock-to-output propagation is $n(t_{C-Q})$, where n is the number of stages and the time t_{C-Q} is the C-to-Qz propagation delay of each stage.

This counter is asynchronously cleared, outputs Low, when power is applied. For FPGA devices, power-on conditions are simulated when global set/reset (GSR) is active. GSR defaults to active-High but can be inverted by adding an inverter in front of the GSR input of the appropriate `STARTUP_architecture` symbol.

Logic Table

Inputs			Outputs
CLR	CE	C	Qz : Q0
1	X	X	0
0	0	X	No Change
0	1	↓	Inc
z = bit width - 1			

Design Entry Method

This design element is only for use in schematics.

For More Information

- See the [Spartan-3 Generation FPGA User Guide \(UG331\)](#).
- See the [Spartan-3E FPGA Family Data Sheet \(DS312\)](#).

D2_4E

Macro: 2- to 4-Line Decoder/Demultiplexer with Enable

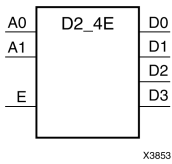

Introduction

This design element is a decoder/demultiplexer. When the enable (E) input of this element is High, one of four active-High outputs (D3 : D0) is selected with a 2-bit binary address (A1 : A0) input. The non-selected outputs are Low. Also, when the E input is Low, all outputs are Low. In demultiplexer applications, the E input is the data input.

Logic Table

Inputs			Outputs			
A1	A0	E	D3	D2	D1	D0
X	X	0	0	0	0	0
0	0	1	0	0	0	1
0	1	1	0	0	1	0
1	0	1	0	1	0	0
1	1	1	1	0	0	0

Design Entry Method

This design element is only for use in schematics.

For More Information

- See the [Spartan-3 Generation FPGA User Guide \(UG331\)](#).
- See the [Spartan-3E FPGA Family Data Sheet \(DS312\)](#).

D3_8E

Macro: 3- to 8-Line Decoder/Demultiplexer with Enable

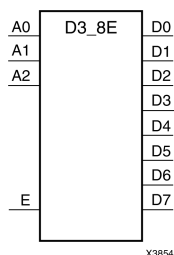

Introduction

When the enable (E) input of the D3_8E decoder/demultiplexer is High, one of eight active-High outputs (D7 : D0) is selected with a 3-bit binary address (A2 : A0) input. The non-selected outputs are Low. Also, when the E input is Low, all outputs are Low. In demultiplexer applications, the E input is the data input.

Logic Table

Inputs				Outputs							
A2	A1	A0	E	D7	D6	D5	D4	D3	D2	D1	D0
X	X	X	0	0	0	0	0	0	0	0	0
0	0	0	1	0	0	0	0	0	0	0	1
0	0	1	1	0	0	0	0	0	0	1	0
0	1	0	1	0	0	0	0	0	1	0	0
0	1	1	1	0	0	0	0	1	0	0	0
1	0	0	1	0	0	0	1	0	0	0	0
1	0	1	1	0	0	1	0	0	0	0	0
1	1	0	1	0	1	0	0	0	0	0	0
1	1	1	1	1	0	0	0	0	0	0	0

Design Entry Method

This design element is only for use in schematics.

For More Information

- See the [Spartan-3 Generation FPGA User Guide \(UG331\)](#).
- See the [Spartan-3E FPGA Family Data Sheet \(DS312\)](#).

D4_16E

Macro: 4- to 16-Line Decoder/Demultiplexer with Enable

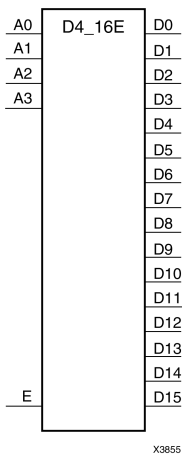

Introduction

This design element is a decoder/demultiplexer. When the enable (E) input of this design element is High, one of 16 active-High outputs (D15 : D0) is selected with a 4-bit binary address (A3 : A0) input. The non-selected outputs are Low. Also, when the E input is Low, all outputs are Low. In demultiplexer applications, the E input is the data input.

Design Entry Method

This design element is only for use in schematics.

For More Information

- See the [Spartan-3 Generation FPGA User Guide \(UG331\)](#).
- See the [Spartan-3E FPGA Family Data Sheet \(DS312\)](#).

DCM_SP

Primitive: Digital Clock Manager

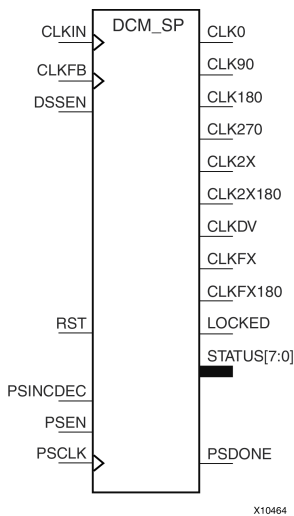

Introduction

This design element is a digital clock manager that provides multiple functions. It can implement a clock delay locked loop (DLL), a digital frequency synthesizer (DFS), and a digital phase shifter (DPS). DCM_SPs are useful for eliminating the clock delay coming on and off the chip, shifting the clock phase to improve data capture, deriving different frequency clocks, as well as other useful clocking functions.

Port Descriptions

Port	Direction	Width	Function
CLKDV	Output	1	Divided clock output, controlled by the CLKDV_DIVIDE attribute. The CLKDV output has a 50% duty cycle unless the CLKDV_DIVIDE attribute is a non-integer value.
CLKFB	Input	1	Clock feedback input to DCM. The feedback input is required unless the DFS outputs, CLKFX or CLKFX180, are used standalone. The source of the CLKFB input must be the CLK0 or CLK2X output from the DCM and the CLK_FEEDBACK must be set to 1X or 2X accordingly. When set to NONE, CLKFB is unused and should be tied low. Ideally, the feedback point includes the delay added by the clock distribution network, either internally or externally.
CLKFX	Output	1	Synthesized clock output, controlled by the CLKFX_MULTIPLY and CLKFX_DIVIDE attributes. Always has a 50% duty cycle. If no phase relationship is necessary, then no clock feedback is required.
CLKFX180	Output	1	Synthesized clock output CLKFX, 180 degree phase shift (an inverted version of CLKFX). Always has a 50% duty cycle. If no phase relationship is necessary, then no feedback loop is required.
CLKIN	Input	1	Clock input to DCM. Always required. The CLKIN frequency and jitter must fall within the limits specified in the data sheet.
CLK0	Output	1	Same frequency as CLKIN, 0 phase shift (i.e., not phase shifted).
CLK2X	Output	1	Double-frequency clock output, 0 degree phase shift. When available, the CLK2X output always has a 50% duty cycle. Either CLK0 or CLK2X is required as a feedback source for DLL functions.

Port	Direction	Width	Function
CLK2X180	Output	1	Double-frequency clock output, 180 degree phase shift. When available, the CLK2X180 output always has a 50% duty cycle.
CLK90	Output	1	Same frequency as CLKIN, 90 degree phase shift (quarter period).
CLK180	Output	1	Same frequency as CLKIN, 180 degree phase shift (half period).
CLK270	Output	1	Same frequency as CLKIN, 270 degree phase shift (three-quarters period).
LOCKED	Output	1	All DCM features have locked onto the CLKIN frequency. Clock outputs are now valid, assuming CLKIN is within specified limits. <ul style="list-style-type: none"> 0 - DCM is attempting to lock onto CLKIN frequency. DCM clock outputs are not valid. 1 - DCM is locked onto CLKIN frequency. DCM clock outputs are valid. 1-to-0 - DCM lost lock. Reset DCM.
PSCLK	Input	1	Clock input to variable phase shifter, clocked on rising edge. When using a global clock buffer, only the upper eight BUFGMUXs can drive PSCLK: BUFGMUX_X2Y1, BUFGMUX_X2Y2, BUFGMUX_X2Y3, BUFGMUX_X2Y4, BUFGMUX_X3Y5, BUFGMUX_X3Y6, BUFGMUX_X3Y7 and BUFGMUX_X3Y8.
PSDONE	Output	1	Variable phase shift operation complete. <ul style="list-style-type: none"> 0 - No phase shift operation is active or phase shift operation is in progress. 1 - Requested phase shift operation is complete. Output High for one PSCLK cycle. Next variable phase shift operation can commence.
PSEN	Input	1	Variable phase-shift enable. Can be inverted within a DCM block. Non-inverted behavior shown below. <ul style="list-style-type: none"> 0 - Disable variable phase shift. Ignore inputs to phase shifter. 1 - Enable variable phase shift operations on next rising PSCLK clock edge. Note Tie to 0 when not in use.
PSINCDEC	Input	1	Increment/decrement variable phase shift. Can be inverted within a DCM block. Non-inverted behavior shown below. <ul style="list-style-type: none"> 0 - Decrement phase shift value on next enabled, rising PSCLK clock edge. 1 - Increment phase shift value on next enabled, rising PSCLK clock edge.
RST	Input	1	Asynchronous reset input. Resets the DCM logic to its postconfiguration state. Causes DCM to reacquire and relock to the CLKIN input. Invertible within DCM block. Non-inverted behavior shown below. <ul style="list-style-type: none"> 0 - No effect. 1 - Reset DCM block. Hold RST pulse High for at least three valid CLKIN cycles.
STATUS[7:0]	Output	8	The status output bus provides DCM status. <ul style="list-style-type: none"> STATUS[0] - Variable phase shift overflow. Control output for variable fine phase shifting. The variable phase shifter has reached a minimum or maximum limit value. The limit value is either +/-255 or a lesser value if the phase shift has reached the end of the delay line.

Port	Direction	Width	Function
			<ul style="list-style-type: none"> - 0 - The phase shift has not yet reached its limit value. - 1 - The phase shift has reached its limited value. • STATUS[1] - CLKIN Input Stopped Indicator. Available only when the CLKFB feedback input is connected. Held in reset until the LOCKED output is asserted. Requires at least one CLKIN cycle to become active. Never asserted if CLKIN never toggles. <ul style="list-style-type: none"> - 0 - CLKIN input is toggling. - 1 - CLKIN input is not toggling even though the locked output can still be High. • STATUS[2] - CLKFX or CLKFX180 output stopped indicator. <ul style="list-style-type: none"> - 0 - CLKFX and CLKFX180 outputs are toggling. - 1 - CLKFX and CLKFX180 outputs are not toggling, even though the LOCKED output can still be High. • STATUS[4:3] - Reserved.

Design Entry Method

This design element can be used in schematics.

Available Attributes

Attribute	Data Type	Allowed Values	Default	Description
CLK_FEEDBACK	String	"1X", "2X", "NONE"	"1X"	Defines the DCM feedback mode. <ul style="list-style-type: none"> • "1X" - CLK0 as feedback. • "2X" - CLK2X as feedback.
CLKDV_DIVIDE	1 significant digit Float	2.0, 1.5, 2.5, 3.0, 3.5, 4.0, 4.5, 5.0, 5.5, 6.0, 6.5, 7.0, 7.5, 8.0, 9.0, 10.0, 11.0, 12.0, 13.0, 14.0, 15.0, 16.0	2.0	Specifies the extent to which the CLKDLL, CLKDLLE, CLKDLLHF, or DCM_SP clock divider (CLKDV output) is to be frequency divided.
CLKFX_DIVIDE	Integer	1 to 32	1	Specifies the frequency divider value for the CLKFX output.
CLKFX_MULTIPLY	Integer	2 to 32	4	Specifies the frequency multiplier value for the CLKFX output.
CLKIN_DIVIDE_BY_2	Boolean	FALSE, TRUE	FALSE	Enables CLKIN divide by two features.
CLKIN_PERIOD	Float	2.000 to 1000.000	None	Specifies the input period to the DCM_SP CLKIN input in ns.

Attribute	Data Type	Allowed Values	Default	Description
CLKOUT_PHASE_SHIFT	String	"NONE", "FIXED", "VARIABLE"	"NONE"	<p>This attribute specifies the phase shift mode.</p> <ul style="list-style-type: none"> "NONE" - No phase shift capability. Any set value has no effect. "FIXED" - DCM outputs are a fixed phase shift from CLKIN. Value is specified by PHASE_SHIFT attribute. "VARIABLE" - Allows the DCM outputs to be shifted in a positive and negative range relative to CLKIN. Starting value is specified by PHASE_SHIFT.
DESKEW_ADJUST	String	"SYSTEM_SYNCHRONOUS", "SOURCE_SYNCHRONOUS"	"SYSTEM_SYNCHRONOUS"	Sets configuration bits affecting the clock delay alignment between the DCM_SP output clocks and an FPGA clock input pin.
DFS_FREQUENCY_MODE	String	"LOW", "HIGH"	"LOW"	This is a legacy attribute. The DCM is always in the automatic frequency search mode. Setting High or Low makes no effect.
DLL_FREQUENCY_MODE	String	"LOW", "HIGH"	"LOW"	This is a legacy attribute. The DCM is always in the automatic frequency search mode. Setting High or Low makes no effect.
DSS_MODE	String	"NONE", "SPREAD_2", "SPREAD_4", "SPREAD_6", "SPREAD_8"	"NONE"	<p>Specifies a frequency spread for output clocks.</p> <ul style="list-style-type: none"> "NONE" - The default, specifies no spread factors. The digital spread spectrum function is disabled. "SPREAD_2" - Creates a new clock period that is +/-50 ps of the current clock period "SPREAD_4" - Creates a new clock period that is +/-100 ps of the current clock period. "SPREAD_6" - Creates a new clock period that is +/-150 ps of the current clock period. "SPREAD_8" - Creates a new clock period that is +/-200 ps of the current clock period. <p>Spreading is cumulative as the value is increased. For example, "SPREAD_2" creates two additional clock frequencies at +/-50 ps relative to the input clock frequency; "SPREAD_4" does the same as "SPREAD_2", plus it creates two additional clock frequencies at +/-100 ps.</p>
DUTY_CYCLE_CORRECTION	Boolean	TRUE, FALSE	TRUE	Unsupported
FACTORY_JF	Hexadecimal	16'h8080 to 16'hffff	16'hc080	Unsupported

Attribute	Data Type	Allowed_Values	Default	Description
PHASE_SHIFT	Integer	-255 to 255	0	The PHASE_SHIFT attribute is applicable only if the CLKOUT_PHASE_SHIFT attribute is set to FIXED or VARIABLE. Defines the rising-edge skew between CLKIN and all the DCM clock outputs at configuration and consequently phase shifts the DCM clock outputs. The skew or phase shift value is specified as an integer that represents a fraction of the clock period as expressed in the equations in Fine Phase Shifting. Actual allowable values depends on input clock frequency. The actual range is less when $TCLKIN > FINE_SHIFT_RANGE$. The FINE_SHIFT_RANGE specification represents the total delay of all taps in the delay line.
STARTUP_WAIT	Boolean	FALSE, TRUE	FALSE	Controls whether the FPGA configuration signal DONE waits for the DCM to assert its LOCKED signal before going High. <ul style="list-style-type: none"> FALSE - Default. DONE is asserted at the end of configuration without waiting for the DCM to assert LOCKED. TRUE - The DONE signal does not transition High until the LOCKED signal transitions High on the associated DCM. <p>STARTUP_WAIT does not prevent LOCKED from transitioning High. The FPGA startup sequence must also be modified to insert a LCK (lock) cycle before the postponed cycle. The DONE cycle or the GWE cycle are typical choices. When more than one DCM is configured, the FPGA waits until all DCMs are LOCKED.</p>

For More Information

- See the [Spartan-3 Generation FPGA User Guide \(UG331\)](#).
- See the [Spartan-3E FPGA Family Data Sheet \(DS312\)](#).

DEC_CC16

Macro: 16-Bit Active Low Decoder

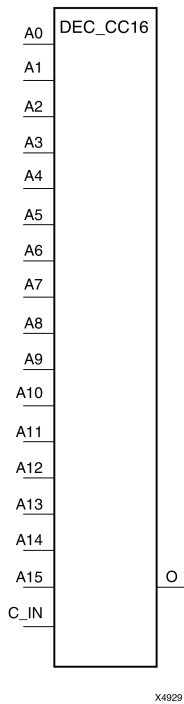

Introduction

This design element is a 16-bit decoder that is used to build wide-decoder functions. It is implemented by cascading CY_MUX elements driven by look-up tables (LUTs). The C_IN pin can only be driven by the output (O) of a previous decode stage. When one or more of the inputs (A) are Low, the output is Low. When all the inputs are High and the C_IN input is High, the output is High. You can decode patterns by adding inverters to inputs.

Logic Table

Inputs					Outputs
A0	A1	...	Az	C_IN	O
1	1	1	1	1	1
X	X	X	X	0	0
0	X	X	X	X	0
X	0	X	X	X	0
X	X	X	0	X	0

z = 3 for DEC_CC4; z = 7 for DEC_CC8; z = 15 for DEC_CC16

Design Entry Method

This design element is only for use in schematics.

For More Information

- See the [Spartan-3 Generation FPGA User Guide \(UG331\)](#).
- See the [Spartan-3E FPGA Family Data Sheet \(DS312\)](#).

DEC_CC4

Macro: 4-Bit Active Low Decoder

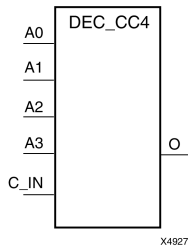

Introduction

This design element is a 4-bit decoder that is used to build wide-decoder functions. It is implemented by cascading CY_MUX elements driven by look-up tables (LUTs). The C_IN pin can only be driven by the output (O) of a previous decode stage. When one or more of the inputs (A) are Low, the output is Low. When all the inputs are High and the C_IN input is High, the output is High. You can decode patterns by adding inverters to inputs.

Logic Table

Inputs					Outputs
A0	A1	...	Az	C_IN	O
1	1	1	1	1	1
X	X	X	X	0	0
0	X	X	X	X	0
X	0	X	X	X	0
X	X	X	0	X	0

z = 3 for DEC_CC4; z = 7 for DEC_CC8; z = 15 for DEC_CC16

Design Entry Method

This design element is only for use in schematics.

For More Information

- See the [Spartan-3 Generation FPGA User Guide \(UG331\)](#).
- See the [Spartan-3E FPGA Family Data Sheet \(DS312\)](#).

DEC_CC8

Macro: 8-Bit Active Low Decoder

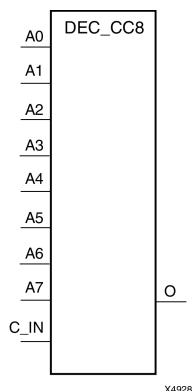

Introduction

This design element is a 8-bit decoder that is used to build wide-decoder functions. It is implemented by cascading CY_MUX elements driven by look-up tables (LUTs). The C_IN pin can only be driven by the output (O) of a previous decode stage. When one or more of the inputs (A) are Low, the output is Low. When all the inputs are High and the C_IN input is High, the output is High. You can decode patterns by adding inverters to inputs.

Logic Table

Inputs					Outputs
A0	A1	...	Az	C_IN	O
1	1	1	1	1	1
X	X	X	X	0	0
0	X	X	X	X	0
X	0	X	X	X	0
X	X	X	0	X	0

z = 3 for DEC_CC4; z = 7 for DEC_CC8; z = 15 for DEC_CC16

Design Entry Method

This design element is only for use in schematics.

For More Information

- See the [Spartan-3 Generation FPGA User Guide \(UG331\)](#).
- See the [Spartan-3E FPGA Family Data Sheet \(DS312\)](#).

DECODE16

Macro: 16-Bit Active-Low Decoder

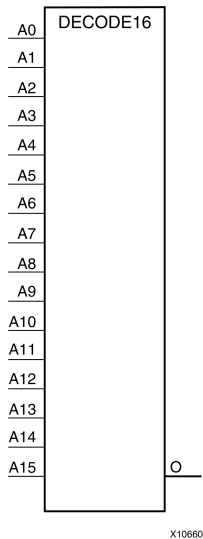

Introduction

This design element is a 4-bit, active-low decoder that is implemented using combinations of LUTs and MUXCYs.

Logic Table

Inputs				Outputs*
A0	A1	...	Az	O
1	1	1	1	1
0	X	X	X	0
X	0	X	X	0
X	X	X	0	0

z = bitwidth -1

*A pull-up resistor must be connected to the output to establish High-level drive current.

Design Entry Method

This design element is only for use in schematics.

For More Information

- See the [Spartan-3 Generation FPGA User Guide \(UG331\)](#).
- See the [Spartan-3E FPGA Family Data Sheet \(DS312\)](#).

DECODE32

Macro: 32-Bit Active-Low Decoder

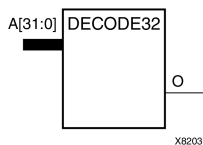

Introduction

This design element is a 32-bit active-low decoder that is implemented using combinations of LUTs and MUXCYs.

Logic Table

Inputs				Outputs
A0	A1	...	Az	O
1	1	1	1	1
0	X	X	X	0
X	0	X	X	0
X	X	X	0	0

z = 31 for DECODE32, z = 63 for DECODE64

Design Entry Method

This design element is only for use in schematics.

For More Information

- See the [Spartan-3 Generation FPGA User Guide \(UG331\)](#).
- See the [Spartan-3E FPGA Family Data Sheet \(DS312\)](#).

DECODE4

Macro: 4-Bit Active-Low Decoder

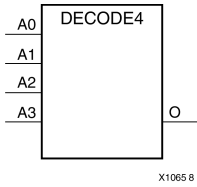

Introduction

This design element is a 4-bit, active-low decoder that is implemented using combinations of LUTs and MUXCYs.

Logic Table

Inputs				Outputs*
A0	A1	...	Az	O
1	1	1	1	1
0	X	X	X	0
X	0	X	X	0
X	X	X	0	0

z = bitwidth -1

*A pull-up resistor must be connected to the output to establish High-level drive current.

Design Entry Method

This design element is only for use in schematics.

For More Information

- See the [Spartan-3 Generation FPGA User Guide \(UG331\)](#).
- See the [Spartan-3E FPGA Family Data Sheet \(DS312\)](#).

DECODE64

Macro: 64-Bit Active-Low Decoder

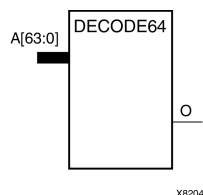

Introduction

This design element is a 64-bit active-low decoder that is implemented using combinations of LUTs and MUXCYs.

Logic Table

Inputs				Outputs
A0	A1	...	Az	O
1	1	1	1	1
0	X	X	X	0
X	0	X	X	0
X	X	X	0	0

z = 31 for DECODE32, z = 63 for DECODE64

Design Entry Method

This design element is only for use in schematics.

For More Information

- See the [Spartan-3 Generation FPGA User Guide \(UG331\)](#).
- See the [Spartan-3E FPGA Family Data Sheet \(DS312\)](#).

DECODE8

Macro: 8-Bit Active-Low Decoder

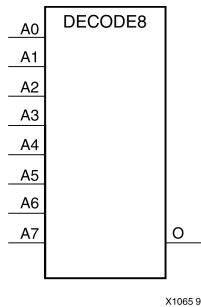

Introduction

This design element is a 8-bit, active-low decoder that is implemented using combinations of LUTs and MUXCY's.

Logic Table

Inputs				Outputs*
A0	A1	...	Az	O
1	1	1	1	1
0	X	X	X	0
X	0	X	X	0
X	X	X	0	0

z = bitwidth -1

*A pull-up resistor must be connected to the output to establish High-level drive current.

Design Entry Method

This design element is only for use in schematics.

For More Information

- See the [Spartan-3 Generation FPGA User Guide \(UG331\)](#).
- See the [Spartan-3E FPGA Family Data Sheet \(DS312\)](#).

FD

Primitive: D Flip-Flop

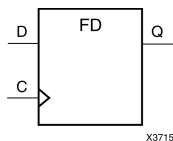

Introduction

This design element is a D-type flip-flop with data input (D) and data output (Q). The data on the D inputs is loaded into the flip-flop during the Low-to-High clock (C) transition.

This flip-flop is asynchronously cleared, outputs Low, when power is applied. For FPGA devices, power-on conditions are simulated when global set/reset (GSR) is active. GSR defaults to active-High but can be inverted by adding an inverter in front of the GSR input of the appropriate `STARTUP_architecture` symbol.

Logic Table

Inputs		Outputs
D	C	Q
0	↑	0
1	↑	1

Design Entry Method

This design element is only for use in schematics.

Available Attributes

Attribute	Data Type	Allowed Values	Default	Description
INIT	Binary	0, 1	0	Sets the initial value of Q output after configuration

For More Information

- See the [Spartan-3 Generation FPGA User Guide \(UG331\)](#).
- See the [Spartan-3E FPGA Family Data Sheet \(DS312\)](#).

FD_1

Primitive: D Flip-Flop with Negative-Edge Clock

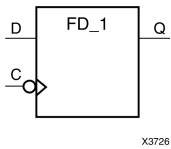

Introduction

This design element is a single D-type flip-flop with data input (D) and data output (Q). The data on the (D) input is loaded into the flip-flop during the High-to-Low clock (C) transition.

This flip-flop is asynchronously cleared, outputs Low, when power is applied. For FPGA devices, power-on conditions are simulated when global set/reset (GSR) is active. GSR defaults to active-High but can be inverted by adding an inverter in front of the GSR input of the appropriate *STARTUP_architecture* symbol.

Logic Table

Inputs		Outputs
D	C	Q
0	↓	0
1	↓	1

Design Entry Method

This design element is only for use in schematics.

Available Attributes

Attribute	Data Type	Allowed Values	Default	Description
INIT	Binary	0, 1	0	Sets the initial value of Q output after configuration

For More Information

- See the [Spartan-3 Generation FPGA User Guide \(UG331\)](#).
- See the [Spartan-3E FPGA Family Data Sheet \(DS312\)](#).

FD16CE

Macro: 16-Bit Data Register with Clock Enable and Asynchronous Clear

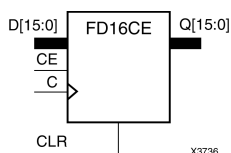

Introduction

This design element is a 16-bit data register with clock enable and asynchronous clear. When clock enable (CE) is High and asynchronous clear (CLR) is Low, the data on the data inputs (D) is transferred to the corresponding data outputs (Q) during the Low-to-High clock (C) transition. When CLR is High, it overrides all other inputs and resets the data outputs (Q) Low. When CE is Low, clock transitions are ignored.

This register is asynchronously cleared, outputs Low, when power is applied. For FPGA devices, power-on conditions are simulated when global set/reset (GSR) is active. GSR defaults to active-High but can be inverted by adding an inverter in front of the GSR input of the appropriate *STARTUP_architecture* symbol.

Logic Table

Inputs				Outputs
CLR	CE	Dz : D0	C	Qz : Q0
1	X	X	X	0
0	0	X	X	No Change
0	1	Dn	↑	Dn

z = bit-width - 1

Design Entry Method

This design element is only for use in schematics.

For More Information

- See the [Spartan-3 Generation FPGA User Guide \(UG331\)](#).
- See the [Spartan-3E FPGA Family Data Sheet \(DS312\)](#).

FD16RE

Macro: 16-Bit Data Register with Clock Enable and Synchronous Reset

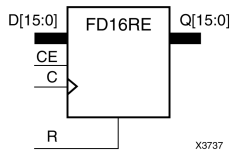

Introduction

This design element is a 16-bit data registers. When the clock enable (CE) input is High, and the synchronous reset (R) input is Low, the data on the data inputs (D) is transferred to the corresponding data outputs (Q0) during the Low-to-High clock (C) transition. When R is High, it overrides all other inputs and resets the data outputs (Q) Low on the Low-to-High clock transition. When CE is Low, clock transitions are ignored.

This register is asynchronously cleared, outputs Low, when power is applied. For FPGA devices, power-on conditions are simulated when global set/reset (GSR) is active. GSR defaults to active-High but can be inverted by adding an inverter in front of the GSR input of the appropriate *STARTUP_architecture* symbol.

Logic Table

Inputs				Outputs
R	CE	Dz : D0	C	Qz : Q0
1	X	X	↑	0
0	0	X	X	No Change
0	1	Dn	↑	Dn

z = bit-width - 1

Design Entry Method

This design element is only for use in schematics.

For More Information

- See the [Spartan-3 Generation FPGA User Guide \(UG331\)](#).
- See the [Spartan-3E FPGA Family Data Sheet \(DS312\)](#).

FD4CE

Macro: 4-Bit Data Register with Clock Enable and Asynchronous Clear

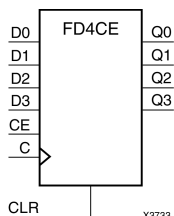

Introduction

This design element is a 4-bit data register with clock enable and asynchronous clear. When clock enable (CE) is High and asynchronous clear (CLR) is Low, the data on the data inputs (D) is transferred to the corresponding data outputs (Q) during the Low-to-High clock (C) transition. When CLR is High, it overrides all other inputs and resets the data outputs (Q) Low. When CE is Low, clock transitions are ignored.

This register is asynchronously cleared, outputs Low, when power is applied. For FPGA devices, power-on conditions are simulated when global set/reset (GSR) is active. GSR defaults to active-High but can be inverted by adding an inverter in front of the GSR input of the appropriate *STARTUP_architecture* symbol.

Logic Table

Inputs				Outputs
CLR	CE	Dz : D0	C	Qz : Q0
1	X	X	X	0
0	0	X	X	No Change
0	1	Dn	↑	Dn

z = bit-width - 1

Design Entry Method

This design element is only for use in schematics.

For More Information

- See the [Spartan-3 Generation FPGA User Guide \(UG331\)](#).
- See the [Spartan-3E FPGA Family Data Sheet \(DS312\)](#).

FD4RE

Macro: 4-Bit Data Register with Clock Enable and Synchronous Reset

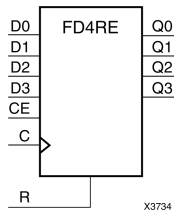

Introduction

This design element is a 4-bit data registers. When the clock enable (CE) input is High, and the synchronous reset (R) input is Low, the data on the data inputs (D) is transferred to the corresponding data outputs (Q0) during the Low-to-High clock (C) transition. When R is High, it overrides all other inputs and resets the data outputs (Q) Low on the Low-to-High clock transition. When CE is Low, clock transitions are ignored.

This register is asynchronously cleared, outputs Low, when power is applied. For FPGA devices, power-on conditions are simulated when global set/reset (GSR) is active. GSR defaults to active-High but can be inverted by adding an inverter in front of the GSR input of the appropriate `STARTUP_architecture` symbol.

Logic Table

Inputs				Outputs
R	CE	Dz : D0	C	Qz : Q0
1	X	X	↑	0
0	0	X	X	No Change
0	1	Dn	↑	Dn

z = bit-width - 1

Design Entry Method

This design element is only for use in schematics.

For More Information

- See the [Spartan-3 Generation FPGA User Guide \(UG331\)](#).
- See the [Spartan-3E FPGA Family Data Sheet \(DS312\)](#).

FD8CE

Macro: 8-Bit Data Register with Clock Enable and Asynchronous Clear

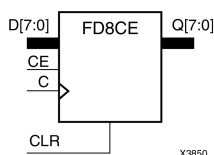

Introduction

This design element is a 8-bit data register with clock enable and asynchronous clear. When clock enable (CE) is High and asynchronous clear (CLR) is Low, the data on the data inputs (D) is transferred to the corresponding data outputs (Q) during the Low-to-High clock (C) transition. When CLR is High, it overrides all other inputs and resets the data outputs (Q) Low. When CE is Low, clock transitions are ignored.

This register is asynchronously cleared, outputs Low, when power is applied. For FPGA devices, power-on conditions are simulated when global set/reset (GSR) is active. GSR defaults to active-High but can be inverted by adding an inverter in front of the GSR input of the appropriate *STARTUP_architecture* symbol.

Logic Table

Inputs				Outputs
CLR	CE	Dz : D0	C	Qz : Q0
1	X	X	X	0
0	0	X	X	No Change
0	1	Dn	↑	Dn

z = bit-width - 1

Design Entry Method

This design element is only for use in schematics.

For More Information

- See the [Spartan-3 Generation FPGA User Guide \(UG331\)](#).
- See the [Spartan-3E FPGA Family Data Sheet \(DS312\)](#).

FD8RE

Macro: 8-Bit Data Register with Clock Enable and Synchronous Reset

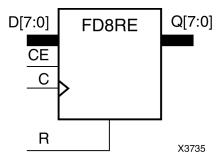

Introduction

This design element is an 8-bit data register. When the clock enable (CE) input is High, and the synchronous reset (R) input is Low, the data on the data inputs (D) is transferred to the corresponding data outputs (Q) during the Low-to-High clock (C) transition. When R is High, it overrides all other inputs and resets the data outputs (Q) Low on the Low-to-High clock transition. When CE is Low, clock transitions are ignored.

This register is asynchronously cleared, outputs Low, when power is applied. For FPGA devices, power-on conditions are simulated when global set/reset (GSR) is active. GSR defaults to active-High but can be inverted by adding an inverter in front of the GSR input of the appropriate *STARTUP_architecture* symbol.

Logic Table

Inputs				Outputs
R	CE	Dz : D0	C	Qz : Q0
1	X	X	↑	0
0	0	X	X	No Change
0	1	Dn	↑	Dn

z = bit-width - 1

Design Entry Method

This design element is only for use in schematics.

For More Information

- See the [Spartan-3 Generation FPGA User Guide \(UG331\)](#).
- See the [Spartan-3E FPGA Family Data Sheet \(DS312\)](#).

FDC

Primitive: D Flip-Flop with Asynchronous Clear

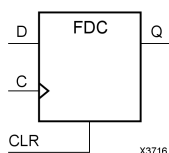

Introduction

This design element is a single D-type flip-flop with data (D) and asynchronous clear (CLR) inputs and data output (Q). The asynchronous CLR, when High, overrides all other inputs and sets the (Q) output Low. The data on the (D) input is loaded into the flip-flop when CLR is Low on the Low-to-High clock transition.

This flip-flop is asynchronously cleared, outputs Low, when power is applied. For FPGA devices, power-on conditions are simulated when global set/reset (GSR) is active. GSR defaults to active-High but can be inverted by adding an inverter in front of the GSR input of the appropriate `STARTUP_architecture` symbol.

Logic Table

Inputs			Outputs
CLR	D	C	Q
1	X	X	0
0	D	↑	D

Design Entry Method

This design element is only for use in schematics.

Available Attributes

Attribute	Data Type	Allowed Values	Default	Description
INIT	Binary	0, 1	0	Sets the initial value of Q output after configuration

For More Information

- See the [Spartan-3 Generation FPGA User Guide \(UG331\)](#).
- See the [Spartan-3E FPGA Family Data Sheet \(DS312\)](#).

FDC_1

Primitive: D Flip-Flop with Negative-Edge Clock and Asynchronous Clear

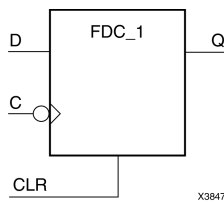

Introduction

FDC_1 is a single D-type flip-flop with data input (D), asynchronous clear input (CLR), and data output (Q). The asynchronous CLR, when active, overrides all other inputs and sets the (Q) output Low. The data on the (D) input is loaded into the flip-flop during the High-to-Low clock (C) transition.

This flip-flop is asynchronously cleared, outputs Low, when power is applied. For FPGA devices, power-on conditions are simulated when global set/reset (GSR) is active. GSR defaults to active-High but can be inverted by adding an inverter in front of the GSR input of the appropriate *STARTUP_architecture* symbol.

Logic Table

Inputs			Outputs
CLR	D	C	Q
1	X	X	0
0	D	↓	D

Design Entry Method

This design element is only for use in schematics.

Available Attributes

Attribute	Data Type	Allowed Values	Default	Description
INIT	Binary	0, 1	0	Sets the initial value of Q output after configuration

For More Information

- See the [Spartan-3 Generation FPGA User Guide \(UG331\)](#).
- See the [Spartan-3E FPGA Family Data Sheet \(DS312\)](#).

FDCE

Primitive: D Flip-Flop with Clock Enable and Asynchronous Clear

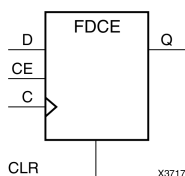

Introduction

This design element is a single D-type flip-flop with clock enable and asynchronous clear. When clock enable (CE) is High and asynchronous clear (CLR) is Low, the data on the data input (D) of this design element is transferred to the corresponding data output (Q) during the Low-to-High clock (C) transition. When CLR is High, it overrides all other inputs and resets the data output (Q) Low. When CE is Low, clock transitions are ignored.

This flip-flop is asynchronously cleared, outputs Low, when power is applied. For FPGA devices, power-on conditions are simulated when global set/reset (GSR) is active. GSR defaults to active-High but can be inverted by adding an inverter in front of the GSR input of the appropriate `STARTUP_architecture` symbol.

Logic Table

Inputs				Outputs
CLR	CE	D	C	Q
1	X	X	X	0
0	0	X	X	No Change
0	1	D	↑	D

Design Entry Method

This design element can be used in schematics.

Available Attributes

Attribute	Data Type	Allowed Values	Default	Description
INIT	Binary	0, 1	0	Sets the initial value of Q output after configuration

For More Information

- See the [Spartan-3 Generation FPGA User Guide \(UG331\)](#).
- See the [Spartan-3E FPGA Family Data Sheet \(DS312\)](#).

FDCE_1

Primitive: D Flip-Flop with Negative-Edge Clock, Clock Enable, and Asynchronous Clear

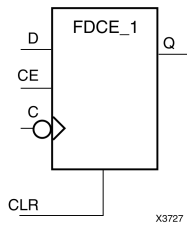

Introduction

This design element is a single D-type flip-flop with data (D), clock enable (CE), asynchronous clear (CLR) inputs, and data output (Q). The asynchronous CLR input, when High, overrides all other inputs and sets the Q output Low. The data on the (D) input is loaded into the flip-flop when CLR is Low and CE is High on the High-to-Low clock (C) transition. When CE is Low, the clock transitions are ignored.

This flip-flop is asynchronously cleared, outputs Low, when power is applied. For FPGA devices, power-on conditions are simulated when global set/reset (GSR) is active. GSR defaults to active-High but can be inverted by adding an inverter in front of the GSR input of the appropriate `STARTUP_architecture` symbol.

Logic Table

Inputs				Outputs
CLR	CE	D	C	Q
1	X	X	X	0
0	0	X	X	No Change
0	1	D	↓	D

Design Entry Method

This design element can be used in schematics.

Available Attributes

Attribute	Data Type	Allowed Values	Default	Description
INIT	Binary	0, 1	0	Sets the initial value of Q output after configuration

For More Information

- See the [Spartan-3 Generation FPGA User Guide \(UG331\)](#).
- See the [Spartan-3E FPGA Family Data Sheet \(DS312\)](#).

FDCP

Primitive: D Flip-Flop with Asynchronous Preset and Clear

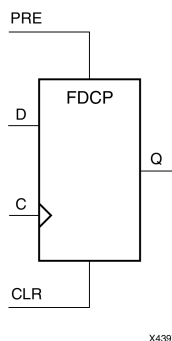

Introduction

This design element is a single D-type flip-flop with data (D), asynchronous preset (PRE) and clear (CLR) inputs, and data output (Q). The asynchronous PRE, when High, sets the (Q) output High; CLR, when High, resets the output Low. Data on the (D) input is loaded into the flip-flop when PRE and CLR are Low on the Low-to-High clock (C) transition.

This flip-flop is asynchronously cleared, outputs Low, when power is applied. For FPGA devices, power-on conditions are simulated when global set/reset (GSR) is active. GSR defaults to active-High but can be inverted by adding an inverter in front of the GSR input of the appropriate `STARTUP_architecture` symbol.

Logic Table

Inputs				Outputs
CLR	PRE	D	C	Q
1	X	X	X	0
0	1	X	X	1
0	0	D	↑	D

Design Entry Method

This design element is only for use in schematics.

Available Attributes

Attribute	Data Type	Allowed Values	Default	Description
INIT	Binary	0, 1	0	Sets the initial value of Q output after configuration

For More Information

- See the [Spartan-3 Generation FPGA User Guide \(UG331\)](#).
- See the [Spartan-3E FPGA Family Data Sheet \(DS312\)](#).

FDCP_1

Primitive: D Flip-Flop with Negative-Edge Clock and Asynchronous Preset and Clear

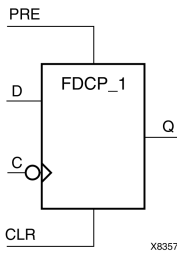

Introduction

This design element is a single D-type flip-flop with data (D), asynchronous preset (PRE) and clear (CLR) inputs, and data output (Q). The asynchronous PRE, when High, sets the (Q) output High; CLR, when High, resets the output Low. Data on the (D) input is loaded into the flip-flop when PRE and CLR are Low on the High-to-Low clock (C) transition.

This flip-flop is asynchronously cleared, outputs Low, when power is applied. For FPGA devices, power-on conditions are simulated when global set/reset (GSR) is active. GSR defaults to active-High but can be inverted by adding an inverter in front of the GSR input of the appropriate STARTUP_architecture symbol.

Logic Table

Inputs				Outputs
CLR	PRE	D	C	Q
1	X	X	X	0
0	1	X	X	1
0	0	0	↓	0
0	0	1	↓	1

Design Entry Method

This design element is only for use in schematics.

Available Attributes

Attribute	Data Type	Allowed Values	Default	Description
INIT	Binary	0, 1	0	Sets the initial value of Q output after configuration

For More Information

- See the [Spartan-3 Generation FPGA User Guide \(UG331\)](#).
- See the [Spartan-3E FPGA Family Data Sheet \(DS312\)](#).

FDCPE

Primitive: D Flip-Flop with Clock Enable and Asynchronous Preset and Clear

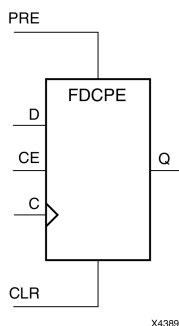

Introduction

This design element is a single D-type flip-flop with data (D), clock enable (CE), asynchronous preset (PRE), and asynchronous clear (CLR) inputs. The asynchronous active high PRE sets the Q output High; that active high CLR resets the output Low and has precedence over the PRE input. Data on the D input is loaded into the flip-flop when PRE and CLR are Low and CE is High on the Low-to-High clock (C) transition. When CE is Low, the clock transitions are ignored and the previous value is retained. The FDCPE is generally implemented as a slice or IOB register within the device.

For FPGA devices, upon power-up, the initial value of this component is specified by the INIT attribute. If a subsequent GSR (Global Set/Reset) is asserted, the flop is asynchronously set to the INIT value.

Note While this device supports the use of asynchronous set and reset, it is not generally recommended to be used for in most cases. Use of asynchronous signals pose timing issues within the design that are difficult to detect and control and also have an adverse affect on logic optimization causing a larger design that can consume more power than if a synchronous set or reset is used.

Logic Table

Inputs					Outputs
CLR	PRE	CE	D	C	Q
1	X	X	X	X	0
0	1	X	X	X	1
0	0	0	X	X	No Change
0	0	1	D	↑	D

Port Descriptions

Port	Direction	Width	Function
Q	Output	1	Data output
C	Input	1	Clock input
CE	Input	1	Clock enable input
CLR	Input	1	Asynchronous clear input
D	Input	1	Data input
PRE	Input	1	Asynchronous set input

Design Entry Method

This design element can be used in schematics.

Available Attributes

Attribute	Data Type	Allowed Values	Default	Description
INIT	Binary	0,1	0	Sets the initial value of Q output after configuration and on GSR.

For More Information

- See the [Spartan-3 Generation FPGA User Guide \(UG331\)](#).
- See the [Spartan-3E FPGA Family Data Sheet \(DS312\)](#).

FDCPE_1

Primitive: D Flip-Flop with Negative-Edge Clock, Clock Enable, and Asynchronous Preset and Clear

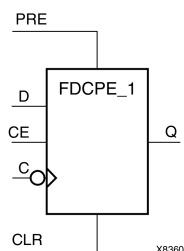

Introduction

FDCPE_1 is a single D-type flip-flop with data (D), clock enable (CE), asynchronous preset (PRE), and asynchronous clear (CLR) inputs and data output (Q). The asynchronous PRE, when High, sets the (Q) output High; CLR, when High, resets the output Low. Data on the (D) input is loaded into the flip-flop when PRE and CLR are Low and CE is High on the High-to-Low clock (C) transition. When CE is Low, the clock transitions are ignored.

This flip-flop is asynchronously cleared, outputs Low, when power is applied. For FPGA devices, power-on conditions are simulated when global set/reset (GSR) is active. GSR defaults to active-High but can be inverted by adding an inverter in front of the GSR input of the appropriate *STARTUP_architecture* symbol.

Logic Table

Inputs					Outputs
CLR	PRE	CE	D	C	Q
1	X	X	X	X	0
0	1	X	X	X	1
0	0	0	X	X	No Change
0	0	1	D	↓	D

Port Descriptions

Port	Direction	Width	Function
Q	Output	1	Data output
C	Input	1	Clock input
CE	Input	1	Clock enable input
CLR	Input	1	Asynchronous clear input
D	Input	1	Data input
PRE	Input	1	Asynchronous set input

Design Entry Method

This design element can be used in schematics.

Available Attributes

Attribute	Data Type	Allowed Values	Default	Description
INIT	Binary	0,1	0	Sets the initial value of Q output after configuration and on GSR.

For More Information

- See the [Spartan-3 Generation FPGA User Guide \(UG331\)](#).
- See the [Spartan-3E FPGA Family Data Sheet \(DS312\)](#).

FDE

Primitive: D Flip-Flop with Clock Enable

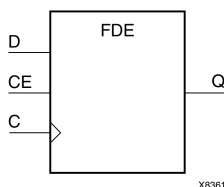

Introduction

This design element is a single D-type flip-flop with data input (D), clock enable (CE), and data output (Q). When clock enable is High, the data on the (D) input is loaded into the flip-flop during the Low-to-High clock (C) transition.

This flip-flop is asynchronously cleared, outputs Low, when power is applied. For FPGA devices, power-on conditions are simulated when global set/reset (GSR) is active. GSR defaults to active-High but can be inverted by adding an inverter in front of the GSR input of the appropriate `STARTUP_architecture` symbol.

Logic Table

Inputs			Outputs
CE	D	C	Q
0	X	X	No Change
1	0	↑	0
1	1	↑	1

Design Entry Method

This design element is only for use in schematics.

Available Attributes

Attribute	Data Type	Allowed Values	Default	Description
INIT	Binary	0, 1	0	Sets the initial value of Q output after configuration

For More Information

- See the [Spartan-3 Generation FPGA User Guide \(UG331\)](#).
- See the [Spartan-3E FPGA Family Data Sheet \(DS312\)](#).

FDE_1

Primitive: D Flip-Flop with Negative-Edge Clock and Clock Enable

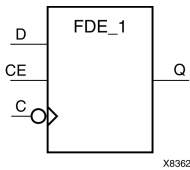

Introduction

This design element is a single D-type flip-flop with data input (D), clock enable (CE), and data output (Q). When clock enable is High, the data on the (D) input is loaded into the flip-flop during the High-to-Low clock (C) transition.

This flip-flop is asynchronously cleared, outputs Low, when power is applied. For FPGA devices, power-on conditions are simulated when global set/reset (GSR) is active. GSR defaults to active-High but can be inverted by adding an inverter in front of the GSR input of the appropriate `STARTUP_architecture` symbol.

Logic Table

Inputs			Outputs
CE	D	C	Q
0	X	X	No Change
1	0	↓	0
1	1	↓	1

Design Entry Method

This design element is only for use in schematics.

Available Attributes

Attribute	Data Type	Allowed Values	Default	Description
INIT	Binary	0, 1	0	Sets the initial value of Q output after configuration

For More Information

- See the [Spartan-3 Generation FPGA User Guide \(UG331\)](#).
- See the [Spartan-3E FPGA Family Data Sheet \(DS312\)](#).

FDP

Primitive: D Flip-Flop with Asynchronous Preset

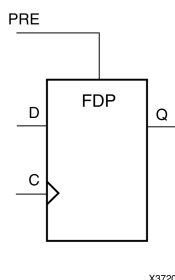

Introduction

This design element is a single D-type flip-flop with data (D) and asynchronous preset (PRE) inputs and data output (Q). The asynchronous PRE, when High, overrides all other inputs and presets the (Q) output High. The data on the (D) input is loaded into the flip-flop when PRE is Low on the Low-to-High clock (C) transition.

For FPGA devices, this flip-flop is asynchronously preset, output High, when power is applied. Power-on conditions are simulated when global set/reset (GSR) is active. GSR defaults to active-High but can be inverted by adding an inverter in front of the GSR input of the appropriate `STARTUP_architecture` symbol.

Logic Table

Inputs			Outputs
PRE	C	D	Q
1	X	X	1
0	↑	D	D

Design Entry Method

This design element is only for use in schematics.

Available Attributes

Attribute	Data Type	Allowed Values	Default	Description
INIT	Binary	0, 1	1	Sets the initial value of Q output after configuration

For More Information

- See the [Spartan-3 Generation FPGA User Guide \(UG331\)](#).
- See the [Spartan-3E FPGA Family Data Sheet \(DS312\)](#).

FDP_1

Primitive: D Flip-Flop with Negative-Edge Clock and Asynchronous Preset

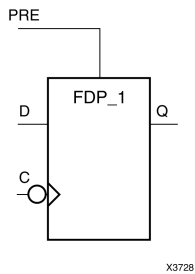

Introduction

This design element is a single D-type flip-flop with data (D) and asynchronous preset (PRE) inputs and data output (Q). The asynchronous PRE, when High, overrides all other inputs and presets the Q output High. The data on the D input is loaded into the flip-flop when PRE is Low on the High-to-Low clock (C) transition.

This flip-flop is asynchronously preset, output High, when power is applied. For FPGA devices, power-on conditions are simulated when global set/reset (GSR) is active. GSR defaults to active-High but can be inverted by adding an inverter in front of the GSR input of the appropriate `STARTUP_architecture` symbol.

Logic Table

Inputs			Outputs
PRE	C	D	Q
1	X	X	1
0	↓	D	D

Design Entry Method

This design element is only for use in schematics.

Available Attributes

Attribute	Data Type	Allowed Values	Default	Description
INIT	Binary	0, 1	1	Sets the initial value of Q output after configuration

For More Information

- See the [Spartan-3 Generation FPGA User Guide \(UG331\)](#).
- See the [Spartan-3E FPGA Family Data Sheet \(DS312\)](#).

FDPE

Primitive: D Flip-Flop with Clock Enable and Asynchronous Preset

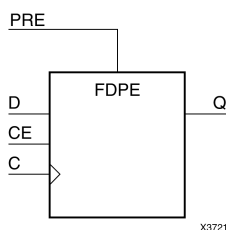

Introduction

This design element is a single D-type flip-flop with data (D), clock enable (CE), and asynchronous preset (PRE) inputs and data output (Q). The asynchronous PRE, when High, overrides all other inputs and sets the (Q) output High. Data on the (D) input is loaded into the flip-flop when PRE is Low and CE is High on the Low-to-High clock (C) transition. When CE is Low, the clock transitions are ignored.

For FPGA devices, this flip-flop is asynchronously preset, output High, when power is applied. Power-on conditions are simulated when global set/reset (GSR) is active. GSR defaults to active-High but can be inverted by adding an inverter in front of the GSR input of the appropriate `STARTUP_architecture` symbol.

Logic Table

Inputs				Outputs
PRE	CE	D	C	Q
1	X	X	X	1
0	0	X	X	No Change
0	1	D	↑	D

Design Entry Method

This design element can be used in schematics.

Available Attributes

Attribute	Data Type	Allowed Values	Default	Description
INIT	Binary	0, 1	1	Sets the initial value of Q output after configuration

For More Information

- See the [Spartan-3 Generation FPGA User Guide \(UG331\)](#).
- See the [Spartan-3E FPGA Family Data Sheet \(DS312\)](#).

FDPE_1

Primitive: D Flip-Flop with Negative-Edge Clock, Clock Enable, and Asynchronous Preset

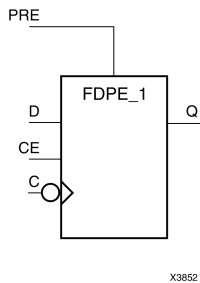

Introduction

This design element is a single D-type flip-flop with data (D), clock enable (CE), and asynchronous preset (PRE) inputs and data output (Q). The asynchronous PRE, when High, overrides all other inputs and sets the (Q) output High. Data on the (D) input is loaded into the flip-flop when PRE is Low and CE is High on the High-to-Low clock (C) transition. When CE is Low, the clock transitions are ignored.

For FPGA devices, this flip-flop is asynchronously preset, output High, when power is applied. Power-on conditions are simulated when global set/reset (GSR) is active. GSR defaults to active-High but can be inverted by adding an inverter in front of the GSR input of the appropriate `STARTUP_architecture` symbol.

Logic Table

Inputs				Outputs
PRE	CE	D	C	Q
1	X	X	X	1
0	0	X	X	No Change
0	1	D	↓	D

Design Entry Method

This design element is only for use in schematics.

Available Attributes

Attribute	Data Type	Allowed Values	Default	Description
INIT	Binary	0, 1	1	Sets the initial value of Q output after configuration

For More Information

- See the [Spartan-3 Generation FPGA User Guide \(UG331\)](#).
- See the [Spartan-3E FPGA Family Data Sheet \(DS312\)](#).

FDR

Primitive: D Flip-Flop with Synchronous Reset

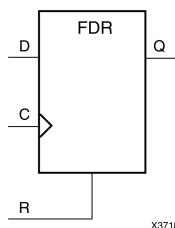

Introduction

This design element is a single D-type flip-flop with data (D) and synchronous reset (R) inputs and data output (Q). The synchronous reset (R) input, when High, overrides all other inputs and resets the (Q) output Low on the Low-to-High clock (C) transition. The data on the (D) input is loaded into the flip-flop when R is Low during the Low-to-High clock transition.

This flip-flop is asynchronously cleared, outputs Low, when power is applied. For FPGA devices, power-on conditions are simulated when global set/reset (GSR) is active. GSR defaults to active-High but can be inverted by adding an inverter in front of the GSR input of the appropriate `STARTUP_architecture` symbol.

Logic Table

Inputs			Outputs
R	D	C	Q
1	X	↑	0
0	D	↑	D

Design Entry Method

This design element is only for use in schematics.

Available Attributes

Attribute	Data Type	Allowed Values	Default	Description
INIT	Binary	0, 1	0	Sets the initial value of Q output after configuration

For More Information

- See the [Spartan-3 Generation FPGA User Guide \(UG331\)](#).
- See the [Spartan-3E FPGA Family Data Sheet \(DS312\)](#).

FDR_1

Primitive: D Flip-Flop with Negative-Edge Clock and Synchronous Reset

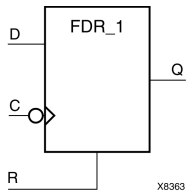

Introduction

This design element is a single D-type flip-flop with data (D) and synchronous reset (R) inputs and data output (Q). The synchronous reset (R) input, when High, overrides all other inputs and resets the (Q) output Low on the High-to-Low clock (C) transition. The data on the (D) input is loaded into the flip-flop when R is Low during the High-to-Low clock transition.

This flip-flop is asynchronously cleared, outputs Low, when power is applied. For FPGA devices, power-on conditions are simulated when global set/reset (GSR) is active. GSR defaults to active-High but can be inverted by adding an inverter in front of the GSR input of the appropriate `STARTUP_architecture` symbol.

Logic Table

Inputs			Outputs
R	D	C	Q
1	X	↓	0
0	D	↓	D

Design Entry Method

This design element is only for use in schematics.

Available Attributes

Attribute	Data Type	Allowed Values	Default	Description
INIT	Binary	0, 1	0	Sets the initial value of Q output after configuration

For More Information

- See the [Spartan-3 Generation FPGA User Guide \(UG331\)](#).
- See the [Spartan-3E FPGA Family Data Sheet \(DS312\)](#).

FDRE

Primitive: D Flip-Flop with Clock Enable and Synchronous Reset

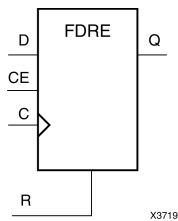

Introduction

This design element is a single D-type flip-flop with data (D), clock enable (CE), and synchronous reset (R) inputs and data output (Q). The synchronous reset (R) input, when High, overrides all other inputs and resets the (Q) output Low on the Low-to-High clock (C) transition. The data on the (D) input is loaded into the flip-flop when R is Low and CE is High during the Low-to-High clock transition.

This flip-flop is asynchronously cleared, outputs Low, when power is applied. For FPGA devices, power-on conditions are simulated when global set/reset (GSR) is active. GSR defaults to active-High but can be inverted by adding an inverter in front of the GSR input of the appropriate `STARTUP_architecture` symbol.

Logic Table

Inputs				Outputs
R	CE	D	C	Q
1	X	X	↑	0
0	0	X	X	No Change
0	1	D	↑	D

Design Entry Method

This design element can be used in schematics.

Available Attributes

Attribute	Data Type	Allowed Values	Default	Description
INIT	Binary	0, 1	0	Sets the initial value of Q output after configuration

For More Information

- See the [Spartan-3 Generation FPGA User Guide \(UG331\)](#).
- See the [Spartan-3E FPGA Family Data Sheet \(DS312\)](#).

FDRE_1

Primitive: D Flip-Flop with Negative-Clock Edge, Clock Enable, and Synchronous Reset

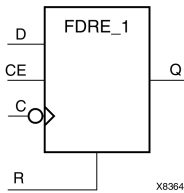

Introduction

FDRE_1 is a single D-type flip-flop with data (D), clock enable (CE), and synchronous reset (R) inputs and data output (Q). The synchronous reset (R) input, when High, overrides all other inputs and resets the (Q) output Low on the High-to-Low clock (C) transition. The data on the (D) input is loaded into the flip-flop when R is Low and CE is High during the High-to-Low clock transition.

This flip-flop is asynchronously cleared, outputs Low, when power is applied. For FPGA devices, power-on conditions are simulated when global set/reset (GSR) is active. GSR defaults to active-High but can be inverted by adding an inverter in front of the GSR input of the appropriate STARTUP_architecture symbol.

Logic Table

Inputs				Outputs
R	CE	D	C	Q
1	X	X	↓	0
0	0	X	X	No Change
0	1	D	↓	D

Design Entry Method

This design element is only for use in schematics.

Available Attributes

Attribute	Data Type	Allowed Values	Default	Description
INIT	Binary	0, 1	0	Sets the initial value of Q output after configuration

For More Information

- See the [Spartan-3 Generation FPGA User Guide \(UG331\)](#).
- See the [Spartan-3E FPGA Family Data Sheet \(DS312\)](#).

FDRS

Primitive: D Flip-Flop with Synchronous Reset and Set

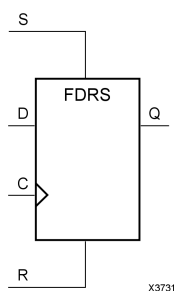

Introduction

FDRS is a single D-type flip-flop with data (D), synchronous set (S), and synchronous reset (R) inputs and data output (Q). The synchronous reset (R) input, when High, overrides all other inputs and resets the (Q) output Low during the Low-to-High clock (C) transition. (Reset has precedence over Set.) When S is High and R is Low, the flip-flop is set, output High, during the Low-to-High clock transition. When R and S are Low, data on the (D) input is loaded into the flip-flop during the Low-to-High clock transition.

This flip-flop is asynchronously cleared, outputs Low, when power is applied. For FPGA devices, power-on conditions are simulated when global set/reset (GSR) is active. GSR defaults to active-High but can be inverted by adding an inverter in front of the GSR input of the appropriate `STARTUP_architecture` symbol.

Logic Table

Inputs				Outputs
R	S	D	C	Q
1	X	X	↑	0
0	1	X	↑	1
0	0	D	↑	D

Design Entry Method

This design element is only for use in schematics.

Available Attributes

Attribute	Data Type	Allowed Values	Default	Description
INIT	Binary	0, 1	0	Sets the initial value of Q output after configuration

For More Information

- See the [Spartan-3 Generation FPGA User Guide \(UG331\)](#).
- See the [Spartan-3E FPGA Family Data Sheet \(DS312\)](#).

FDRS_1

Primitive: D Flip-Flop with Negative-Clock Edge and Synchronous Reset and Set

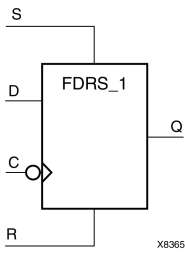

Introduction

FDRS_1 is a single D-type flip-flop with data (D), synchronous set (S), and synchronous reset (R) inputs and data output (Q). The synchronous reset (R) input, when High, overrides all other inputs and resets the (Q) output Low during the High-to-Low clock (C) transition. (Reset has precedence over Set.) When S is High and R is Low, the flip-flop is set, output High, during the High-to-Low clock transition. When R and S are Low, data on the (D) input is loaded into the flip-flop during the High-to-Low clock transition.

This flip-flop is asynchronously cleared, outputs Low, when power is applied. For FPGA devices, power-on conditions are simulated when global set/reset (GSR) is active. GSR defaults to active-High but can be inverted by adding an inverter in front of the GSR input of the appropriate *STARTUP_architecture* symbol.

Logic Table

Inputs				Outputs
R	S	D	C	Q
1	X	X	↓	0
0	1	X	↓	1
0	0	D	↓	D

Design Entry Method

This design element is only for use in schematics.

Available Attributes

Attribute	Data Type	Allowed Values	Default	Description
INIT	Binary	0, 1	0	Sets the initial value of Q output after configuration

For More Information

- See the [Spartan-3 Generation FPGA User Guide \(UG331\)](#).
- See the [Spartan-3E FPGA Family Data Sheet \(DS312\)](#).

FDRSE

Primitive: D Flip-Flop with Synchronous Reset and Set and Clock Enable

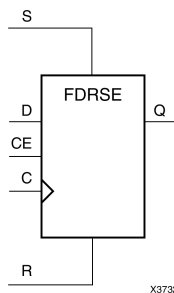

Introduction

FDRSE is a single D-type flip-flop with synchronous reset (R), synchronous set (S), clock enable (CE) inputs. The reset (R) input, when High, overrides all other inputs and resets the Q output Low during the Low-to-High clock transition. (Reset has precedence over Set.) When the set (S) input is High and R is Low, the flip-flop is set, output High, during the Low-to-High clock (C) transition. Data on the D input is loaded into the flip-flop when R and S are Low and CE is High during the Low-to-High clock transition.

Upon power-up, the initial value of this component is specified by the INIT attribute. If a subsequent GSR (Global Set/Reset) is asserted, the flop is asynchronously set to the INIT value.

Logic Table

Inputs					Outputs
R	S	CE	D	C	Q
1	X	X	X	↑	0
0	1	X	X	↑	1
0	0	0	X	X	No Change
0	0	1	1	↑	1
0	0	1	0	↑	0

Design Entry Method

This design element can be used in schematics.

Available Attributes

Attribute	Data Type	Allowed Values	Default	Description
INIT	Binary	0,1	0	Sets the initial value of Q output after configuration and on GSR.

For More Information

- See the [Spartan-3 Generation FPGA User Guide \(UG331\)](#).
- See the [Spartan-3E FPGA Family Data Sheet \(DS312\)](#).

FDRSE_1

Primitive: D Flip-Flop with Negative-Clock Edge, Synchronous Reset and Set, and Clock Enable

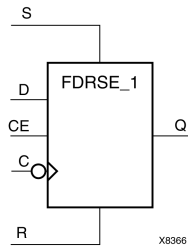

Introduction

FDRSE_1 is a single D-type flip-flop with synchronous reset (R), synchronous set (S), and clock enable (CE) inputs and data output (Q). The reset (R) input, when High, overrides all other inputs and resets the (Q) output Low during the High-to-Low clock transition. (Reset has precedence over Set.) When the set (S) input is High and R is Low, the flip-flop is set, output High, during the High-to-Low clock (C) transition. Data on the (D) input is loaded into the flip-flop when (R) and (S) are Low and (CE) is High during the High-to-Low clock transition.

This flip-flop is asynchronously cleared, outputs Low, when power is applied. For FPGA devices, power-on conditions are simulated when global set/reset (GSR) is active. GSR defaults to active-High but can be inverted by adding an inverter in front of the GSR input of the appropriate STARTUP_architecture symbol.

Logic Table

Inputs					Outputs
R	S	CE	D	C	Q
1	X	X	X	↓	0
0	1	X	X	↓	1
0	0	0	X	X	No Change
0	0	1	D	↓	D

Design Entry Method

This design element can be used in schematics.

Available Attributes

Attribute	Data Type	Allowed Values	Default	Description
INIT	Binary	0,1	0	Sets the initial value of Q output after configuration and on GSR.

For More Information

- See the [Spartan-3 Generation FPGA User Guide \(UG331\)](#).
- See the [Spartan-3E FPGA Family Data Sheet \(DS312\)](#).

FDS

Primitive: D Flip-Flop with Synchronous Set

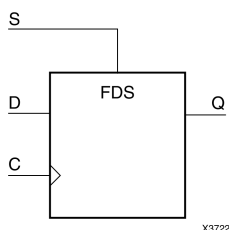

Introduction

FDS is a single D-type flip-flop with data (D) and synchronous set (S) inputs and data output (Q). The synchronous set input, when High, sets the Q output High on the Low-to-High clock (C) transition. The data on the D input is loaded into the flip-flop when S is Low during the Low-to-High clock (C) transition.

For FPGA devices, this flip-flop is asynchronously preset, output High, when power is applied. Power-on conditions are simulated when global set/reset (GSR) is active. GSR defaults to active-High but can be inverted by adding an inverter in front of the GSR input of the appropriate `STARTUP_architecture` symbol.

Logic Table

Inputs			Outputs
S	D	C	Q
1	X	↑	1
0	D	↑	D

Design Entry Method

This design element is only for use in schematics.

Available Attributes

Attribute	Data Type	Allowed Values	Default	Description
INIT	Binary	0, 1	1	Sets the initial value of Q output after configuration.

For More Information

- See the [Spartan-3 Generation FPGA User Guide \(UG331\)](#).
- See the [Spartan-3E FPGA Family Data Sheet \(DS312\)](#).

FDS_1

Primitive: D Flip-Flop with Negative-Edge Clock and Synchronous Set

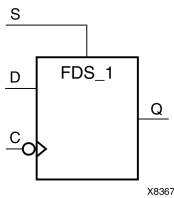

Introduction

FDS is a single D-type flip-flop with data (D) and synchronous set (S) inputs and data output (Q). The synchronous set input, when High, sets the Q output High on the Low-to-High clock (C) transition. The data on the D input is loaded into the flip-flop when S is Low during the Low-to-High clock (C) transition.

This flip-flop is asynchronously preset, output High, when power is applied. For FPGA devices, power-on conditions are simulated when global set/reset (GSR) is active. GSR defaults to active-High but can be inverted by adding an inverter in front of the GSR input of the appropriate *STARTUP_architecture* symbol.

Logic Table

Inputs			Outputs
S	D	C	Q
1	X	↓	1
0	D	↓	D

Design Entry Method

This design element is only for use in schematics.

Available Attributes

Attribute	Data Type	Allowed Values	Default	Description
INIT	Binary	0, 1	1	Sets the initial value of Q output after configuration.

For More Information

- See the [Spartan-3 Generation FPGA User Guide \(UG331\)](#).
- See the [Spartan-3E FPGA Family Data Sheet \(DS312\)](#).

FDSE

Primitive: D Flip-Flop with Clock Enable and Synchronous Set

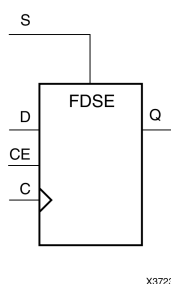

Introduction

FDSE is a single D-type flip-flop with data (D), clock enable (CE), and synchronous set (S) inputs and data output (Q). The synchronous set (S) input, when High, overrides the clock enable (CE) input and sets the Q output High during the Low-to-High clock (C) transition. The data on the D input is loaded into the flip-flop when S is Low and CE is High during the Low-to-High clock (C) transition.

For FPGA devices, this flip-flop is asynchronously preset, output High, when power is applied. Power-on conditions are simulated when global set/reset (GSR) is active. GSR defaults to active-High but can be inverted by adding an inverter in front of the GSR input of the appropriate `STARTUP_architecture` symbol.

Logic Table

Inputs				Outputs
S	CE	D	C	Q
1	X	X	↑	1
0	0	X	X	No Change
0	1	D	↑	D

Design Entry Method

This design element can be used in schematics.

Available Attributes

Attribute	Data Type	Allowed Values	Default	Description
INIT	Binary	0, 1	1	Sets the initial value of Q output after configuration

For More Information

- See the [Spartan-3 Generation FPGA User Guide \(UG331\)](#).
- See the [Spartan-3E FPGA Family Data Sheet \(DS312\)](#).

FDSE_1

Primitive: D Flip-Flop with Negative-Edge Clock, Clock Enable, and Synchronous Set

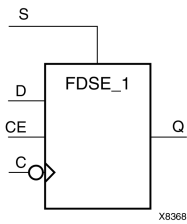

Introduction

FDSE_1 is a single D-type flip-flop with data (D), clock enable (CE), and synchronous set (S) inputs and data output (Q). The synchronous set (S) input, when High, overrides the clock enable (CE) input and sets the Q output High during the High-to-Low clock (C) transition. The data on the D input is loaded into the flip-flop when S is Low and CE is High during the High-to-Low clock (C) transition.

This flip-flop is asynchronously preset, output High, when power is applied. For FPGA devices, power-on conditions are simulated when global set/reset (GSR) is active. GSR defaults to active-High but can be inverted by adding an inverter in front of the GSR input of the appropriate STARTUP_architecture symbol.

Logic Table

Inputs				Outputs
S	CE	D	C	Q
1	X	X	↓	1
0	0	X	X	No Change
0	1	D	↓	D

Design Entry Method

This design element is only for use in schematics.

Available Attributes

Attribute	Data Type	Allowed Values	Default	Description
INIT	Binary	0, 1	1	Sets the initial value of Q output after configuration

For More Information

- See the [Spartan-3 Generation FPGA User Guide \(UG331\)](#).
- See the [Spartan-3E FPGA Family Data Sheet \(DS312\)](#).

FJKC

Macro: J-K Flip-Flop with Asynchronous Clear

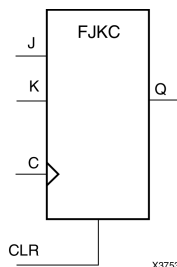

Introduction

This design element is a single J-K-type flip-flop with J, K, and asynchronous clear (CLR) inputs and data output (Q). The asynchronous clear (CLR) input, when High, overrides all other inputs and resets the Q output Low. When CLR is Low, the output responds to the state of the J and K inputs, as shown in the following logic table, during the Low-to-High clock (C) transition.

This flip-flop is asynchronously cleared, outputs Low, when power is applied. For FPGA devices, power-on conditions are simulated when global set/reset (GSR) is active. GSR defaults to active-High but can be inverted by adding an inverter in front of the GSR input of the appropriate `STARTUP_architecture` symbol.

Logic Table

Inputs				Outputs
CLR	J	K	C	Q
1	X	X	X	0
0	0	0	↑	No Change
0	0	1	↑	0
0	1	0	↑	1
0	1	1	↑	Toggle

Design Entry Method

This design element is only for use in schematics.

Available Attributes

Attribute	Data Type	Allowed Values	Default	Description
INIT	Binary	0, 1	0	Sets the initial value of Q output after configuration

For More Information

- See the [Spartan-3 Generation FPGA User Guide \(UG331\)](#).
- See the [Spartan-3E FPGA Family Data Sheet \(DS312\)](#).

FJKCE

Macro: J-K Flip-Flop with Clock Enable and Asynchronous Clear

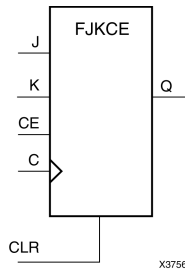

Introduction

This design element is a single J-K-type flip-flop with J, K, clock enable (CE), and asynchronous clear (CLR) inputs and data output (Q). The asynchronous clear (CLR), when High, overrides all other inputs and resets the Q output Low. When CLR is Low and CE is High, Q responds to the state of the J and K inputs, as shown in the following logic table, during the Low-to-High clock transition. When CE is Low, the clock transitions are ignored.

This flip-flop is asynchronously cleared, outputs Low, when power is applied. For FPGA devices, power-on conditions are simulated when global set/reset (GSR) is active. GSR defaults to active-High but can be inverted by adding an inverter in front of the GSR input of the appropriate `STARTUP_architecture` symbol.

Logic Table

Inputs					Outputs
CLR	CE	J	K	C	Q
1	X	X	X	X	0
0	0	X	X	X	No Change
0	1	0	0	X	No Change
0	1	0	1	↑	0
0	1	1	0	↑	1
0	1	1	1	↑	Toggle

Design Entry Method

This design element is only for use in schematics.

Available Attributes

Attribute	Data Type	Allowed Values	Default	Description
INIT	Binary	0, 1	0	Sets the initial value of Q output after configuration

For More Information

- See the [Spartan-3 Generation FPGA User Guide \(UG331\)](#).
- See the [Spartan-3E FPGA Family Data Sheet \(DS312\)](#).

FJKP

Macro: J-K Flip-Flop with Asynchronous Preset

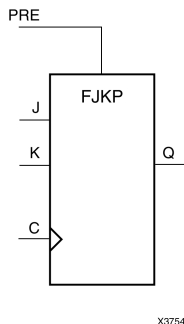

Introduction

This design element is a single J-K-type flip-flop with J, K, and asynchronous preset (PRE) inputs and data output (Q). The asynchronous preset (PRE) input, when High, overrides all other inputs and sets the (Q) output High. When (PRE) is Low, the (Q) output responds to the state of the J and K inputs, as shown in the following logic table, during the Low-to-High clock transition.

For FPGA devices, this flip-flop is asynchronously preset, output High, when power is applied. Power-on conditions are simulated when global set/reset (GSR) is active. GSR defaults to active-High but can be inverted by adding an inverter in front of the GSR input of the appropriate `STARTUP_architecture` symbol.

Logic Table

Inputs				Outputs
PRE	J	K	C	Q
1	X	X	X	1
0	0	0	X	No Change
0	0	1	↑	0
0	1	0	↑	1
0	1	1	↑	Toggle

Design Entry Method

This design element is only for use in schematics.

Available Attributes

Attribute	Data Type	Allowed Values	Default	Description
INIT	Binary	0, 1	1	Sets the initial value of Q output after configuration

For More Information

- See the [Spartan-3 Generation FPGA User Guide \(UG331\)](#).
- See the [Spartan-3E FPGA Family Data Sheet \(DS312\)](#).

FJKPE

Macro: J-K Flip-Flop with Clock Enable and Asynchronous Preset

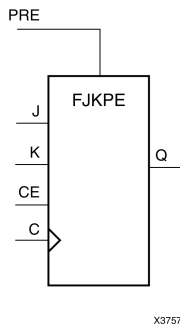

Introduction

This design element is a single J-K-type flip-flop with J, K, clock enable (CE), and asynchronous preset (PRE) inputs and data output (Q). The asynchronous preset (PRE), when High, overrides all other inputs and sets the (Q) output High. When (PRE) is Low and (CE) is High, the (Q) output responds to the state of the J and K inputs, as shown in the logic table, during the Low-to-High clock (C) transition. When (CE) is Low, clock transitions are ignored.

For FPGA devices, this flip-flop is asynchronously preset, output High, when power is applied. Power-on conditions are simulated when global set/reset (GSR) is active. GSR defaults to active-High but can be inverted by adding an inverter in front of the GSR input of the appropriate STARTUP_architecture symbol.

Logic Table

Inputs					Outputs
PRE	CE	J	K	C	Q
1	X	X	X	X	1
0	0	X	X	X	No Change
0	1	0	0	X	No Change
0	1	0	1	↑	0
0	1	1	0	↑	1
0	1	1	1	↑	Toggle

Design Entry Method

This design element is only for use in schematics.

Available Attributes

Attribute	Data Type	Allowed Values	Default	Description
INIT	Binary	0, 1	1	Sets the initial value of Q output after configuration

For More Information

- See the [Spartan-3 Generation FPGA User Guide \(UG331\)](#).
- See the [Spartan-3E FPGA Family Data Sheet \(DS312\)](#).

FJKRSE

Macro: J-K Flip-Flop with Clock Enable and Synchronous Reset and Set

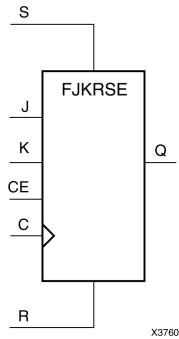

Introduction

This design element is a single J-K-type flip-flop with J, K, synchronous reset (R), synchronous set (S), and clock enable (CE) inputs and data output (Q). When synchronous reset (R) is High during the Low-to-High clock (C) transition, all other inputs are ignored and output (Q) is reset Low. When synchronous set (S) is High and (R) is Low, output (Q) is set High. When (R) and (S) are Low and (CE) is High, output (Q) responds to the state of the J and K inputs, according to the following logic table, during the Low-to-High clock (C) transition. When (CE) is Low, clock transitions are ignored.

This flip-flop is asynchronously cleared, outputs Low, when power is applied. For FPGA devices, power-on conditions are simulated when global set/reset (GSR) is active. GSR defaults to active-High but can be inverted by adding an inverter in front of the GSR input of the appropriate `STARTUP_architecture` symbol.

Logic Table

Inputs						Outputs
R	S	CE	J	K	C	Q
1	X	X	X	X	↑	0
0	1	X	X	X	↑	1
0	0	0	X	X	X	No Change
0	0	1	0	0	X	No Change
0	0	1	0	1	↑	0
0	0	1	1	0	↑	1
0	0	1	1	0	↑	1
0	0	1	1	1	↑	Toggle

Design Entry Method

This design element is only for use in schematics.

Available Attributes

Attribute	Data Type	Allowed Values	Default	Description
INIT	Binary	0, 1	0	Sets the initial value of Q output after configuration

For More Information

- See the [Spartan-3 Generation FPGA User Guide \(UG331\)](#).
- See the [Spartan-3E FPGA Family Data Sheet \(DS312\)](#).

FJKSRE

Macro: J-K Flip-Flop with Clock Enable and Synchronous Set and Reset

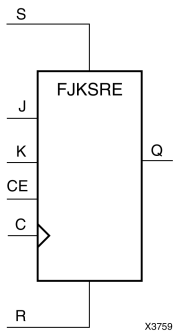

Introduction

This design element is a single J-K-type flip-flop with J, K, synchronous set (S), synchronous reset (R), and clock enable (CE) inputs and data output (Q). When synchronous set (S) is High during the Low-to-High clock (C) transition, all other inputs are ignored and output (Q) is set High. When synchronous reset (R) is High and (S) is Low, output (Q) is reset Low. When (S) and (R) are Low and (CE) is High, output (Q) responds to the state of the J and K inputs, as shown in the following logic table, during the Low-to-High clock (C) transition. When (CE) is Low, clock transitions are ignored.

This flip-flop is asynchronously cleared, outputs Low, when power is applied. For FPGA devices, power-on conditions are simulated when global set/reset (GSR) is active. GSR defaults to active-High but can be inverted by adding an inverter in front of the GSR input of the appropriate *STARTUP_architecture* symbol.

Logic Table

Inputs						Outputs
S	R	CE	J	K	C	Q
1	X	X	X	X	↑	1
0	1	X	X	X	↑	0
0	0	0	X	X	X	No Change
0	0	1	0	0	X	No Change
0	0	1	0	1	↑	0
0	0	1	1	0	↑	1
0	0	1	1	1	↑	Toggle

Design Entry Method

This design element is only for use in schematics.

Available Attributes

Attribute	Data Type	Allowed Values	Default	Description
INIT	Binary	0, 1	1	Sets the initial value of Q output after configuration.

For More Information

- See the [Spartan-3 Generation FPGA User Guide \(UG331\)](#).
- See the [Spartan-3E FPGA Family Data Sheet \(DS312\)](#).

FTC

Macro: Toggle Flip-Flop with Asynchronous Clear

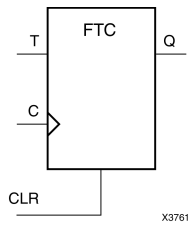

Introduction

This design element is a synchronous, resettable toggle flip-flop. The asynchronous clear (CLR) input, when High, overrides all other inputs and resets the data output (Q) Low. The (Q) output toggles, or changes state, when the toggle enable (T) input is High and (CLR) is Low during the Low-to-High clock transition.

This flip-flop is asynchronously cleared, outputs Low, when power is applied. For FPGA devices, power-on conditions are simulated when global set/reset (GSR) is active. GSR defaults to active-High but can be inverted by adding an inverter in front of the GSR input of the appropriate STARTUP_architecture symbol.

Logic Table

Inputs			Outputs
CLR	T	C	Q
1	X	X	0
0	0	X	No Change
0	1	↑	Toggle

Design Entry Method

You can instantiate this element when targeting a CPLD, but not when you are targeting an FPGA.

Available Attributes

Attribute	Data Type	Allowed Values	Default	Description
INIT	Binary	0, 1	0	Sets the initial value of Q output after configuration

For More Information

- See the [Spartan-3 Generation FPGA User Guide \(UG331\)](#).
- See the [Spartan-3E FPGA Family Data Sheet \(DS312\)](#).

FTCE

Macro: Toggle Flip-Flop with Clock Enable and Asynchronous Clear

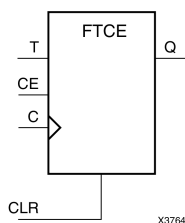

Introduction

This design element is a toggle flip-flop with toggle and clock enable and asynchronous clear. When the asynchronous clear (CLR) input is High, all other inputs are ignored and the data output (Q) is reset Low. When CLR is Low and toggle enable (T) and clock enable (CE) are High, Q output toggles, or changes state, during the Low-to-High clock (C) transition. When CE is Low, clock transitions are ignored.

This flip-flop is asynchronously cleared, outputs Low, when power is applied. For FPGA devices, power-on conditions are simulated when global set/reset (GSR) is active. GSR defaults to active-High but can be inverted by adding an inverter in front of the GSR input of the appropriate `STARTUP_architecture` symbol.

Logic Table

Inputs				Outputs
CLR	CE	T	C	Q
1	X	X	X	0
0	0	X	X	No Change
0	1	0	X	No Change
0	1	1	↑	Toggle

Design Entry Method

This design element is only for use in schematics.

Available Attributes

Attribute	Data Type	Allowed Values	Default	Description
INIT	Binary	0, 1	0	Sets the initial value of Q output after configuration

For More Information

- See the [Spartan-3 Generation FPGA User Guide \(UG331\)](#).
- See the [Spartan-3E FPGA Family Data Sheet \(DS312\)](#).

FTCLE

Macro: Toggle/Loadable Flip-Flop with Clock Enable and Asynchronous Clear

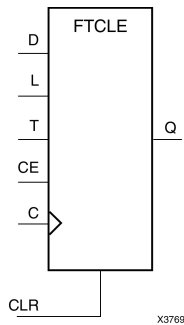

Introduction

This design element is a toggle/loadable flip-flop with toggle and clock enable and asynchronous clear. When the asynchronous clear input (CLR) is High, all other inputs are ignored and output Q is reset Low. When load enable input (L) is High and CLR is Low, clock enable (CE) is overridden and the data on data input (D) is loaded into the flip-flop during the Low-to-High clock (C) transition. When toggle enable (T) and CE are High and L and CLR are Low, output Q toggles, or changes state, during the Low- to-High clock transition. When CE is Low, clock transitions are ignored.

This flip-flop is asynchronously cleared, outputs Low, when power is applied. For FPGA devices, power-on conditions are simulated when global set/reset (GSR) is active. GSR defaults to active-High but can be inverted by adding an inverter in front of the GSR input of the appropriate STARTUP_architecture symbol.

Logic Table

Inputs						Outputs
CLR	L	CE	T	D	C	Q
1	X	X	X	X	X	0
0	1	X	X	D	↑	D
0	0	0	X	X	X	No Change
0	0	1	0	X	X	No Change
0	0	1	1	X	↑	Toggle

Design Entry Method

This design element is only for use in schematics.

Available Attributes

Attribute	Data Type	Allowed Values	Default	Description
INIT	Binary	0, 1	0	Sets the initial value of Q output after configuration

For More Information

- See the [Spartan-3 Generation FPGA User Guide \(UG331\)](#).
- See the [Spartan-3E FPGA Family Data Sheet \(DS312\)](#).

FTCLEX

Macro: Toggle/Loadable Flip-Flop with Clock Enable and Asynchronous Clear

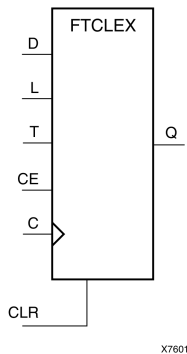

Introduction

This design element is a toggle/loadable flip-flop with toggle and clock enable and asynchronous clear. When the asynchronous clear input (CLR) is High, all other inputs are ignored and output Q is reset Low. When load enable input (L) is High, CLR is Low, and CE is High, the data on data input (D) is loaded into the flip-flop during the Low-to-High clock (C) transition. When toggle enable (T) and CE are High and L and CLR are Low, output Q toggles, or changes state, during the Low- to-High clock transition. When CE is Low, clock transitions are ignored.

This flip-flop is asynchronously cleared, outputs Low, when power is applied. For FPGA devices, power-on conditions are simulated when global set/reset (GSR) is active. GSR defaults to active-High but can be inverted by adding an inverter in front of the GSR input of the appropriate STARTUP_architecture symbol.

Logic Table

Inputs						Outputs
CLR	L	CE	T	D	C	Q
1	X	X	X	X	X	0
0	1	X	X	D	↑	D
0	0	0	X	X	X	No Change
0	0	1	0	X	X	No Change
0	0	1	1	X	↑	Toggle

Design Entry Method

This design element is only for use in schematics.

Available Attributes

Attribute	Data Type	Allowed Values	Default	Description
INIT	Binary	0, 1	0	Sets the initial value of Q output after configuration

For More Information

- See the [Spartan-3 Generation FPGA User Guide \(UG331\)](#).
- See the [Spartan-3E FPGA Family Data Sheet \(DS312\)](#).

FTP

Macro: Toggle Flip-Flop with Asynchronous Preset

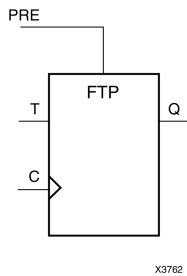

Introduction

This design element is a toggle flip-flop with toggle enable and asynchronous preset. When the asynchronous preset (PRE) input is High, all other inputs are ignored and output (Q) is set High. When toggle-enable input (T) is High and (PRE) is Low, output (Q) toggles, or changes state, during the Low-to-High clock (C) transition.

For FPGA devices, this flip-flop is asynchronously preset, output High, when power is applied. Power-on conditions are simulated when global set/reset (GSR) is active. GSR defaults to active-High but can be inverted by adding an inverter in front of the GSR input of the appropriate `STARTUP_architecture` symbol.

Logic Table

Inputs			Outputs
PRE	T	C	Q
1	X	X	1
0	0	X	No Change
0	1	↑	Toggle

Design Entry Method

This design element is only for use in schematics.

Available Attributes

Attribute	Data Type	Allowed Values	Default	Description
INIT	Binary	0, 1	1	Sets the initial value of Q output after configuration

For More Information

- See the [Spartan-3 Generation FPGA User Guide \(UG331\)](#).
- See the [Spartan-3E FPGA Family Data Sheet \(DS312\)](#).

FTPE

Macro: Toggle Flip-Flop with Clock Enable and Asynchronous Preset

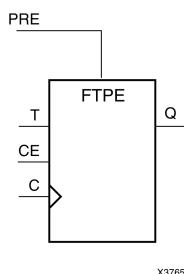

Introduction

This design element is a toggle flip-flop with toggle and clock enable and asynchronous preset. When the asynchronous preset (PRE) input is High, all other inputs are ignored and output (Q) is set High. When the toggle enable input (T) is High, clock enable (CE) is High, and (PRE) is Low, output (Q) toggles, or changes state, during the Low-to-High clock transition. When (CE) is Low, clock transitions are ignored.

For FPGA devices, this flip-flop is asynchronously preset, output High, when power is applied. Power-on conditions are simulated when global set/reset (GSR) is active. GSR defaults to active-High but can be inverted by adding an inverter in front of the GSR input of the appropriate `STARTUP_architecture` symbol.

Logic Table

Inputs				Outputs
PRE	CE	T	C	Q
1	X	X	X	1
0	0	X	X	No Change
0	1	0	X	No Change
0	1	1	↑	Toggle

Design Entry Method

This design element is only for use in schematics.

Available Attributes

Attribute	Data Type	Allowed Values	Default	Description
INIT	Binary	0, 1	1	Sets the initial value of Q output after configuration

For More Information

- See the [Spartan-3 Generation FPGA User Guide \(UG331\)](#).
- See the [Spartan-3E FPGA Family Data Sheet \(DS312\)](#).

FTPLE

Macro: Toggle/Loadable Flip-Flop with Clock Enable and Asynchronous Preset

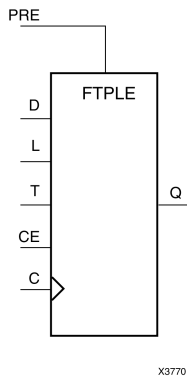

Introduction

This design element is a toggle/loadable flip-flop with toggle and clock enable and asynchronous preset. When the asynchronous preset input (PRE) is High, all other inputs are ignored and output (Q) is set High. When the load enable input (L) is High and (PRE) is Low, the clock enable (CE) is overridden and the data (D) is loaded into the flip-flop during the Low-to-High clock transition. When L and PRE are Low and toggle-enable input (T) and (CE) are High, output (Q) toggles, or changes state, during the Low-to-High clock transition. When (CE) is Low, clock transitions are ignored.

For FPGA devices, this flip-flop is asynchronously preset, output High, when power is applied. Power-on conditions are simulated when global set/reset (GSR) is active. GSR defaults to active-High but can be inverted by adding an inverter in front of the GSR input of the appropriate `STARTUP_architecture` symbol.

Logic Table

Inputs						Outputs
PRE	L	CE	T	D	C	Q
1	X	X	X	X	X	1
0	1	X	X	D	↑	D
0	0	0	X	X	X	No Change
0	0	1	0	X	X	No Change
0	0	1	1	X	↑	Toggle

Design Entry Method

This design element is only for use in schematics.

Available Attributes

Attribute	Data Type	Allowed Values	Default	Description
INIT	Binary	0, 1	1	Sets the initial value of Q output after configuration

For More Information

- See the [Spartan-3 Generation FPGA User Guide \(UG331\)](#).
- See the [Spartan-3E FPGA Family Data Sheet \(DS312\)](#).

FTRSE

Macro: Toggle Flip-Flop with Clock Enable and Synchronous Reset and Set

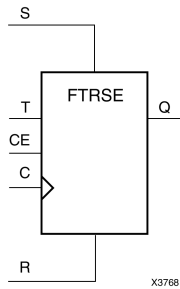

Introduction

This design element is a toggle flip-flop with toggle and clock enable and synchronous reset and set. When the synchronous reset input (R) is High, it overrides all other inputs and the data output (Q) is reset Low. When the synchronous set input (S) is High and (R) is Low, clock enable input (CE) is overridden and output (Q) is set High. (Reset has precedence over Set.) When toggle enable input (T) and (CE) are High and (R) and (S) are Low, output (Q) toggles, or changes state, during the Low-to-High clock transition.

This flip-flop is asynchronously cleared, outputs Low, when power is applied. For FPGA devices, power-on conditions are simulated when global set/reset (GSR) is active. GSR defaults to active-High but can be inverted by adding an inverter in front of the GSR input of the appropriate *STARTUP_architecture* symbol.

Logic Table

Inputs					Outputs
R	S	CE	T	C	Q
1	X	X	X	↑	0
0	1	X	X	↑	1
0	0	0	X	X	No Change
0	0	1	0	X	No Change
0	0	1	1	↑	Toggle

Design Entry Method

This design element is only for use in schematics.

Available Attributes

Attribute	Data Type	Allowed Values	Default	Description
INIT	Binary	0, 1	0	Sets the initial value of Q output after configuration

For More Information

- See the [Spartan-3 Generation FPGA User Guide \(UG331\)](#).
- See the [Spartan-3E FPGA Family Data Sheet \(DS312\)](#).

FTRSLE

Macro: Toggle/Loadable Flip-Flop with Clock Enable and Synchronous Reset and Set

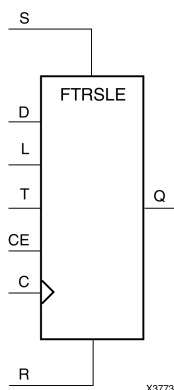

Introduction

This design element is a toggle/loadable flip-flop with toggle and clock enable and synchronous reset and set. The synchronous reset input (R), when High, overrides all other inputs and resets the data output (Q) Low. (Reset has precedence over Set.) When R is Low and synchronous set input (S) is High, the clock enable input (CE) is overridden and output Q is set High. When R and S are Low and load enable input (L) is High, CE is overridden and data on data input (D) is loaded into the flip-flop during the Low-to-High clock transition. When R, S, and L are Low, CE is High and T is High, output Q toggles, or changes state, during the Low-to-High clock transition. When CE is Low, clock transitions are ignored.

This flip-flop is asynchronously cleared, outputs Low, when power is applied. For FPGA devices, power-on conditions are simulated when global set/reset (GSR) is active. GSR defaults to active-High but can be inverted by adding an inverter in front of the GSR input of the appropriate `STARTUP_architecture` symbol.

Logic Table

Inputs							Outputs
R	S	L	CE	T	D	C	Q
1	0	X	X	X	X	↑	0
0	1	X	X	X	X	↑	1
0	0	1	X	X	1	↑	1
0	0	1	X	X	0	↑	0
0	0	0	0	X	X	X	No Change
0	0	0	1	0	X	X	No Change
0	0	0	1	1	X	↑	Toggle

Design Entry Method

This design element is only for use in schematics.

Available Attributes

Attribute	Data Type	Allowed Values	Default	Description
INIT	Binary	0, 1	0	Sets the initial value of Q output after configuration

For More Information

- See the [Spartan-3 Generation FPGA User Guide \(UG331\)](#).
- See the [Spartan-3E FPGA Family Data Sheet \(DS312\)](#).

FTSRE

Macro: Toggle Flip-Flop with Clock Enable and Synchronous Set and Reset

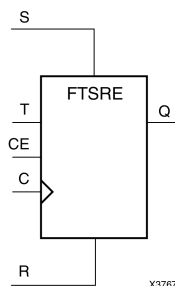

Introduction

This design element is a toggle flip-flop with toggle and clock enable and synchronous set and reset. The synchronous set input, when High, overrides all other inputs and sets data output (Q) High. (Set has precedence over Reset.) When synchronous reset input (R) is High and S is Low, clock enable input (CE) is overridden and output Q is reset Low. When toggle enable input (T) and CE are High and S and R are Low, output Q toggles, or changes state, during the Low-to-High clock transition. When CE is Low, clock transitions are ignored.

This flip-flop is asynchronously cleared, outputs Low, when power is applied. For FPGA devices, power-on conditions are simulated when global set/reset (GSR) is active. GSR defaults to active-High but can be inverted by adding an inverter in front of the GSR input of the appropriate *STARTUP_architecture* symbol.

Logic Table

Inputs					Outputs
S	R	CE	T	C	Q
1	X	X	X	↑	1
0	1	X	X	↑	0
0	0	0	X	X	No Change
0	0	1	0	X	No Change
0	0	1	1	↑	Toggle

Design Entry Method

This design element is only for use in schematics.

Available Attributes

Attribute	Data Type	Allowed Values	Default	Description
INIT	Binary	0, 1	1	Sets the initial value of Q output after configuration.

For More Information

- See the [Spartan-3 Generation FPGA User Guide \(UG331\)](#).
- See the [Spartan-3E FPGA Family Data Sheet \(DS312\)](#).

FTSRLE

Macro: Toggle/Loadable Flip-Flop with Clock Enable and Synchronous Set and Reset

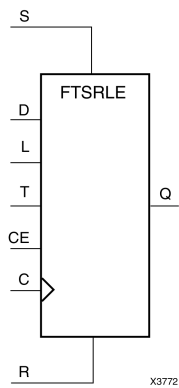

Introduction

This design element is a toggle/loadable flip-flop with toggle and clock enable and synchronous set and reset. The synchronous set input (S), when High, overrides all other inputs and sets data output (Q) High. (Set has precedence over Reset.) When synchronous reset (R) is High and (S) is Low, clock enable input (CE) is overridden and output (Q) is reset Low. When load enable input (L) is High and S and R are Low, CE is overridden and data on data input (D) is loaded into the flip-flop during the Low-to-High clock transition. When the toggle enable input (T) and (CE) are High and (S), (R), and (L) are Low, output (Q) toggles, or changes state, during the Low-to-High clock transition. When (CE) is Low, clock transitions are ignored.

For FPGA devices, power-on conditions are simulated when global set/reset (GSR) is active. GSR defaults to active-High but can be inverted by adding an inverter in front of the GSR input of the appropriate `STARTUP_architecture` symbol.

Logic Table

Inputs							Outputs
S	R	L	CE	T	D	C	Q
1	X	X	X	X	X	↑	1
0	1	X	X	X	X	↑	0
0	0	1	X	X	1	↑	1
0	0	1	X	X	0	↑	0
0	0	0	0	X	X	X	No Change
0	0	0	1	0	X	X	No Change
0	0	0	1	1	X	↑	Toggle

Design Entry Method

This design element is only for use in schematics.

Available Attributes

Attribute	Data Type	Allowed Values	Default	Description
INIT	Binary	0, 1	1	Sets the initial value of Q output after configuration.

For More Information

- See the [Spartan-3 Generation FPGA User Guide \(UG331\)](#).
- See the [Spartan-3E FPGA Family Data Sheet \(DS312\)](#).

GND

Primitive: Ground-Connection Signal Tag

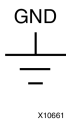

Introduction

The GND signal tag, or parameter, forces a net or input function to a Low logic level. A net tied to GND cannot have any other source.

When the logic-trimming software or fitter encounters a net or input function tied to GND, it removes any logic that is disabled by the GND signal. The GND signal is only implemented when the disabled logic cannot be removed.

Design Entry Method

This design element is only for use in schematics.

For More Information

- See the [Spartan-3 Generation FPGA User Guide \(UG331\)](#).
- See the [Spartan-3E FPGA Family Data Sheet \(DS312\)](#).

IBUF

Primitive: Input Buffer

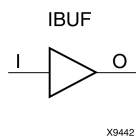

Introduction

This design element is automatically inserted (inferred) by the synthesis tool to any signal directly connected to a top-level input or in-out port of the design. You should generally let the synthesis tool infer this buffer. However, it can be instantiated into the design if required. In order to do so, connect the input port (I) directly to the associated top-level input or in-out port, and connect the output port (O) to the logic sourced by that port. Modify any necessary generic maps (VHDL) or named parameter value assignment (Verilog) in order to change the default behavior of the component.

Port Descriptions

Port	Direction	Width	Function
O	Output	1	Buffer output
I	Input	1	Buffer input

Design Entry Method

This design element can be used in schematics.

Available Attributes

Attribute	Data Type	Allowed Values	Default	Description
IBUF_DELAY_VALUE	String	"0" through "12"	"0"	Specifies the amount of additional delay to add to the non-registered path out of the IOB.
IFD_DELAY_VALUE	String	"AUTO", "0" through "6"	"AUTO"	Specifies the amount of additional delay to add to the registered path within the IOB.
IOSTANDARD	String	See Data Sheet.	"DEFAULT"	Assigns an I/O standard to the element.

For More Information

- See the [Spartan-3 Generation FPGA User Guide \(UG331\)](#).
- See the [Spartan-3E FPGA Family Data Sheet \(DS312\)](#).

IBUF16

Macro: 16-Bit Input Buffer

IBUF16

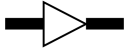

X3815

Introduction

Input Buffers isolate the internal circuit from the signals coming into the chip. This design element is contained in input/output blocks (IOBs) and allows the specification of the particular I/O Standard to configure the I/O. In general, an this element should be used for all single-ended data input or bidirectional pins.

Design Entry Method

This design element can be used in schematics.

Available Attributes

Attribute	Data Type	Allowed Values	Default	Description
IBUF_DELAY_VALUE	String	"0" through "12"	"0"	Specifies the amount of additional delay to add to the non-registered path out of the IOB.
IFD_DELAY_VALUE	String	"AUTO", "0" through "6"	"AUTO"	Specifies the amount of additional delay to add to the registered path within the IOB.
IOSTANDARD	String	See Data Sheet.	"DEFAULT"	Assigns an I/O standard to the element.

For More Information

- See the [Spartan-3 Generation FPGA User Guide \(UG331\)](#).
- See the [Spartan-3E FPGA Family Data Sheet \(DS312\)](#).

IBUF4

Macro: 4-Bit Input Buffer

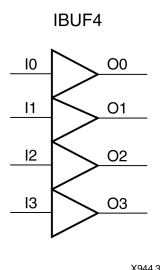

Introduction

Input Buffers isolate the internal circuit from the signals coming into the chip. This design element is contained in input/output blocks (IOBs) and allows the specification of the particular I/O Standard to configure the I/O. In general, an this element should be used for all single-ended data input or bidirectional pins.

Design Entry Method

This design element can be used in schematics.

Available Attributes

Attribute	Data Type	Allowed Values	Default	Description
IBUF_DELAY_VALUE	String	"0" through "12"	"0"	Specifies the amount of additional delay to add to the non-registered path out of the IOB.
IFD_DELAY_VALUE	String	"AUTO", "0" through "6"	"AUTO"	Specifies the amount of additional delay to add to the registered path within the IOB.
IOSTANDARD	String	See Data Sheet.	"DEFAULT"	Assigns an I/O standard to the element.

For More Information

- See the [Spartan-3 Generation FPGA User Guide \(UG331\)](#).
- See the [Spartan-3E FPGA Family Data Sheet \(DS312\)](#).

IBUF8

Macro: 8-Bit Input Buffer

IBUF8

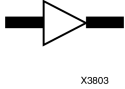

Introduction

Input Buffers isolate the internal circuit from the signals coming into the chip. This design element is contained in input/output blocks (IOBs) and allows the specification of the particular I/O Standard to configure the I/O. In general, an this element should be used for all single-ended data input or bidirectional pins.

Design Entry Method

This design element can be used in schematics.

Available Attributes

Attribute	Data Type	Allowed Values	Default	Description
IBUF_DELAY_VALUE	String	"0" through "12"	"0"	Specifies the amount of additional delay to add to the non-registered path out of the IOB.
IFD_DELAY_VALUE	String	"AUTO", "0" through "6"	"AUTO"	Specifies the amount of additional delay to add to the registered path within the IOB.
IOSTANDARD	String	See Data Sheet.	"DEFAULT"	Assigns an I/O standard to the element.

For More Information

- See the [Spartan-3 Generation FPGA User Guide \(UG331\)](#).
- See the [Spartan-3E FPGA Family Data Sheet \(DS312\)](#).

IBUFDS

Primitive: Differential Signaling Input Buffer

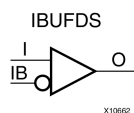

Introduction

This design element is an input buffer that supports low-voltage, differential signaling. In IBUFDS, a design level interface signal is represented as two distinct ports (I and IB), one deemed the "master" and the other the "slave." The master and the slave are opposite phases of the same logical signal (for example, MYNET_P and MYNET_N). Optionally, a programmable differential termination feature is available to help improve signal integrity and reduce external components.

Logic Table

Inputs		Outputs
I	IB	O
0	0	No Change
0	1	0
1	0	1
1	1	No Change

Port Descriptions

Port	Direction	Width	Function
I	Input	1	Diff_p Buffer Input
IB	Input	1	Diff_n Buffer Input
O	Output	1	Buffer Output

Design Entry Method

This design element can be used in schematics.

Put all I/O components on the top-level of the design to help facilitate hierarchical design methods. Connect the I port directly to the top-level "master" input port of the design, the IB port to the top-level "slave" input port, and the O port to the logic in which this input is to source. Specify the desired generic/defparam values in order to configure the proper behavior of the buffer.

Available Attributes

Attribute	Data Type	Allowed Values	Default	Description
DIFF_TERM	Boolean	TRUE or FALSE	FALSE	Enables the built-in differential termination resistor.
IBUF_DELAY_VALUE	String	"0" through "12"	"0"	Specifies the amount of additional delay to add to the non-registered path out of the IOB.
IFD_DELAY_VALUE	String	"AUTO", "0" thru "6"	"AUTO"	Specifies the amount of additional delay to add to the registered path within the IOB.
IOSTANDARD	String	See Data Sheet.	"DEFAULT"	Assigns an I/O standard to the element.

For More Information

- See the [Spartan-3 Generation FPGA User Guide \(UG331\)](#).
- See the [Spartan-3E FPGA Family Data Sheet \(DS312\)](#).

IBUFG

Primitive: Dedicated Input Clock Buffer

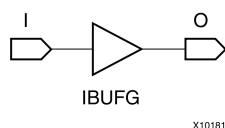

Introduction

The IBUFG is a dedicated input to the device which should be used to connect incoming clocks to the FPGA's global clock routing resources. The IBUFG provides dedicated connections to the DCM_SP and BUFG providing the minimum amount of clock delay and jitter to the device. The IBUFG input can only be driven by the global clock pins. The IBUFG output can drive CLKIN of a DCM_SP, BUFG, or your choice of logic.

Port Descriptions

Port	Direction	Width	Function
O	Output	1	Clock Buffer output
I	Input	1	Clock Buffer input

Design Entry Method

This design element can be used in schematics.

Available Attributes

Attribute	Data Type	Allowed Values	Default	Description
IBUF_DELAY_VALUE	String	"0" through "12"	"0"	Specifies the amount of additional delay to add to the non-registered path out of the IOB
IOSTANDARD	String	See Data Sheet	"DEFAULT"	Assigns an I/O standard to the element.

For More Information

- See the [Spartan-3 Generation FPGA User Guide \(UG331\)](#).
- See the [Spartan-3E FPGA Family Data Sheet \(DS312\)](#).

IBUFGDS

Primitive: Differential Signaling Dedicated Input Clock Buffer and Optional Delay

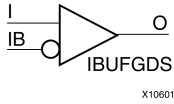

Introduction

This design element is a dedicated differential signaling input buffer for connection to the clock buffer (BUFG) or . In IBUFGDS, a design-level interface signal is represented as two distinct ports (I and IB), one deemed the "master" and the other the "slave." The master and the slave are opposite phases of the same logical signal (for example, MYNET_P and MYNET_N). Optionally, a programmable differential termination feature is available to help improve signal integrity and reduce external components. Also available is a programmable delay is to assist in the capturing of incoming data to the device.

Logic Table

Inputs		Outputs
I	IB	O
0	0	No Change
0	1	0
1	0	1
1	1	No Change

Port Descriptions

Port	Direction	Width	Function
O	Output	1	Clock Buffer output
IB	Input	1	Diff_n Clock Buffer Input
I	Input	1	Diff_p Clock Buffer Input

Design Entry Method

This design element can be used in schematics.

Put all I/O components on the top-level of the design to help facilitate hierarchical design methods. Connect the I port directly to the top-level "master" input port of the design, the IB port to the top-level "slave" input port and the O port to , BUFG or logic in which this input is to source. Some synthesis tools infer the BUFG automatically if necessary, when connecting an IBUFG to the clock resources of the FPGA. Specify the desired generic/defparam values in order to configure the proper behavior of the buffer.

Available Attributes

Attribute	Data Type	Allowed Values	Default	Description
DIFF_TERM	Boolean	TRUE or FALSE	FALSE	Enables the built-in differential termination resistor.
IBUF_DELAY_VALUE	String	"0" through "12"	"0"	Specifies the amount of additional delay to add to the non-registered path out of the IOB
IOSTANDARD	String	See Data Sheet	"DEFAULT"	Assigns an I/O standard to the element.

For More Information

- See the [Spartan-3 Generation FPGA User Guide \(UG331\)](#).
- See the [Spartan-3E FPGA Family Data Sheet \(DS312\)](#).

IDDR2

Primitive: Double Data Rate Input D Flip-Flop with Optional Data Alignment, Clock Enable and Programmable Synchronous or Asynchronous Set/Reset

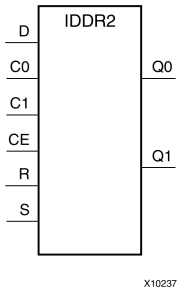

Introduction

This design element is a dedicated input register designed to receive external dual data rate (DDR) signals into Xilinx® FPGAs. The IDDR2 requires two clocks to be connected to the component, C0 and C1, so that data is captured at the positive edge of both C0 and C1 clocks. The IDDR2 features an active high clock enable port, CE, which be used to suspend the operation of the registers, and both set and reset ports that be configured to be synchronous or asynchronous to the respective clocks. The IDDR2 has an optional alignment feature that allows both output data ports to the component to be aligned to a single clock.

Logic Table

Input						Output	
S	R	CE	D	C0	C1	Q0	Q1
1	x	x	x	x	x	INIT_Q0	INIT_Q1
0	1	x	x	x	x	not INIT_Q0	not INIT_Q1
0	0	0	x	x	x	No Change	No Change
0	0	1	D	↑	x	D	No Change
0	0	1	D	x	↑	No Change	D

Set/Reset can be synchronous via SRTYPE value

Design Entry Method

This design element can be used in schematics.

All inputs and outputs of this component should either be connected or properly tied off.

Available Attributes

Attribute	Data Type	Allowed Values	Default	Description
DDR_ALIGNMENT	String	"NONE", "C0", "C1"	"NONE"	Sets the output alignment more for the DDR register <ul style="list-style-type: none"> NONE - Makes the data available on the Q0 and Q1 outputs shortly after the corresponding C0 or C1 positive clock edge. C0 - Makes the data on both Q0 and Q1 align to the positive edge of the C0 clock. C1 - Makes the data on both Q0 and Q1 align to the positive edge of the C1 clock.
INIT_Q0	Integer	0, 1	0	Sets initial state of the Q0 output to 0 or 1.
INIT_Q1	Integer	0, 1	0	Sets initial state of the Q1 output to 0 or 1.
SRTYPE	String	"SYNC", "ASYNC"	"SYNC"	Specifies "SYNC" or "ASYNC" set/reset.

For More Information

See the [Spartan-3 Generation FPGA User Guide \(UG331\)](#).

IFD

Macro: Input D Flip-Flop

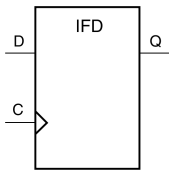

X3776

Introduction

This D-type flip-flop is contained in an input/output block (IOB). The input (D) of the flip-flop is connected to an IPAD or an IOPAD (without using an IBUF). The (D) input provides data input for the flip-flop, which synchronizes data entering the chip. The data on input (D) is loaded into the flip-flop during the Low-to-High clock (C) transition and appears at the output (Q). The clock input can be driven by internal logic or through another external pin.

This flip-flop is asynchronously cleared, outputs Low, when power is applied. For FPGA devices, power-on conditions are simulated when global set/reset (GSR) is active. GSR defaults to active-High but can be inverted by adding an inverter in front of the GSR input of the appropriate `STARTUP_architecture` symbol.

Logic Table

Inputs		Outputs
D	C	Q
D	↑	D

Design Entry Method

This design element is only for use in schematics.

For More Information

- See the [Spartan-3 Generation FPGA User Guide \(UG331\)](#).
- See the [Spartan-3E FPGA Family Data Sheet \(DS312\)](#).

IFD_1

Macro: Input D Flip-Flop with Inverted Clock (Asynchronous Preset)

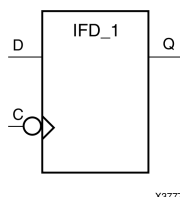

Introduction

This design element is a D-type flip flop which is contained in an input/output block (IOB). The input (D) of the flip-flop is connected to an IPAD or an IOPAD. The D input also provides data input for the flip-flop, which synchronizes data entering the chip. The D input data is loaded into the flip-flop during the High-to-Low clock (C) transition and appears at the output (Q). The clock input can be driven by internal logic or through another external pin.

This flip-flop is asynchronously cleared, outputs Low, when power is applied. For FPGA devices, power-on conditions are simulated when global set/reset (GSR) is active. GSR defaults to active-High but can be inverted by adding an inverter in front of the GSR input of the appropriate `STARTUP_architecture` symbol.

Logic Table

Inputs		Outputs
D	C	Q
0	↓	0
1	↓	1

Design Entry Method

This design element is only for use in schematics.

For More Information

- See the [Spartan-3 Generation FPGA User Guide \(UG331\)](#).
- See the [Spartan-3E FPGA Family Data Sheet \(DS312\)](#).

IFD16

Macro: 16-Bit Input D Flip-Flop

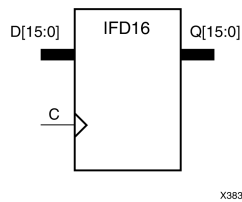

Introduction

This D-type flip-flop is contained in an input/output block (IOB). The input (D) of the flip-flop is connected to an IPAD or an IOPAD (without using an IBUF). The (D) input provides data input for the flip-flop, which synchronizes data entering the chip. The data on input (D) is loaded into the flip-flop during the Low-to-High clock (C) transition and appears at the output (Q). The clock input can be driven by internal logic or through another external pin.

This flip-flop is asynchronously cleared, outputs Low, when power is applied. For FPGA devices, power-on conditions are simulated when global set/reset (GSR) is active. GSR defaults to active-High but can be inverted by adding an inverter in front of the GSR input of the appropriate `STARTUP_architecture` symbol.

Logic Table

Inputs		Outputs
D	C	Q
D	↑	D

Design Entry Method

This design element is only for use in schematics.

For More Information

- See the [Spartan-3 Generation FPGA User Guide \(UG331\)](#).
- See the [Spartan-3E FPGA Family Data Sheet \(DS312\)](#).

IFD4

Macro: 4-Bit Input D Flip-Flop

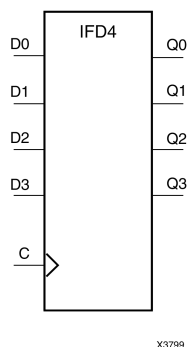

Introduction

This D-type flip-flop is contained in an input/output block (IOB). The input (D) of the flip-flop is connected to an IPAD or an IOPAD (without using an IBUF). The (D) input provides data input for the flip-flop, which synchronizes data entering the chip. The data on input (D) is loaded into the flip-flop during the Low-to-High clock (C) transition and appears at the output (Q). The clock input can be driven by internal logic or through another external pin.

This flip-flop is asynchronously cleared, outputs Low, when power is applied. For FPGA devices, power-on conditions are simulated when global set/reset (GSR) is active. GSR defaults to active-High but can be inverted by adding an inverter in front of the GSR input of the appropriate *STARTUP_architecture* symbol.

Logic Table

Inputs		Outputs
D	C	Q
D	↑	D

Design Entry Method

This design element is only for use in schematics.

For More Information

- See the [Spartan-3 Generation FPGA User Guide \(UG331\)](#).
- See the [Spartan-3E FPGA Family Data Sheet \(DS312\)](#).

IFD8

Macro: 8-Bit Input D Flip-Flop

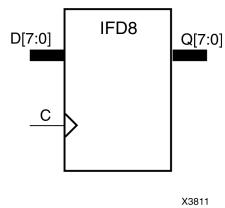

Introduction

This D-type flip-flop is contained in an input/output block (IOB). The input (D) of the flip-flop is connected to an IPAD or an IOPAD (without using an IBUF). The (D) input provides data input for the flip-flop, which synchronizes data entering the chip. The data on input (D) is loaded into the flip-flop during the Low-to-High clock (C) transition and appears at the output (Q). The clock input can be driven by internal logic or through another external pin.

This flip-flop is asynchronously cleared, outputs Low, when power is applied. For FPGA devices, power-on conditions are simulated when global set/reset (GSR) is active. GSR defaults to active-High but can be inverted by adding an inverter in front of the GSR input of the appropriate `STARTUP_architecture` symbol.

Logic Table

Inputs		Outputs
D	C	Q
D	↑	D

Design Entry Method

This design element is only for use in schematics.

For More Information

- See the [Spartan-3 Generation FPGA User Guide \(UG331\)](#).
- See the [Spartan-3E FPGA Family Data Sheet \(DS312\)](#).

IFDI

Macro: Input D Flip-Flop (Asynchronous Preset)

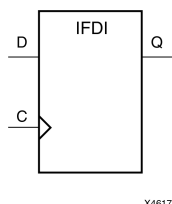

Introduction

This design element is a D-type flip-flop which is contained in an input/output block (IOB). The input (D) of the flip-flop is connected to an IPAD or an IOPAD. The D input provides data input for the flip-flop, which synchronizes data entering the chip. The D input data is loaded into the flip-flop during the Low-to-High clock (C) transition and appears at the output (Q). The clock input can be driven by internal logic or through another external pin.

This flip-flop is asynchronously cleared, outputs Low, when power is applied. For FPGA devices, power-on conditions are simulated when global set/reset (GSR) is active. GSR defaults to active-High but can be inverted by adding an inverter in front of the GSR input of the appropriate `STARTUP_architecture` symbol.

Logic Table

Inputs		Outputs
D	C	Q
D	↑	D

Design Entry Method

This design element is only for use in schematics.

For More Information

- See the [Spartan-3 Generation FPGA User Guide \(UG331\)](#).
- See the [Spartan-3E FPGA Family Data Sheet \(DS312\)](#).

IFDI_1

Macro: Input D Flip-Flop with Inverted Clock (Asynchronous Preset)

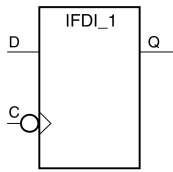

X4386

Introduction

The design element is a D-type flip-flop is contained in an input/output block (IOB). The input (D) of the flip-flop is connected to an IPAD or an IOPAD. The (D) input provides data input for the flip-flop, which synchronizes data entering the chip. The data on input (D) is loaded into the flip-flop during the High-to-Low clock (C) transition and appears at the output (Q). The clock input can be driven by internal logic or through another external pin.

This flip-flop is asynchronously cleared, outputs Low, when power is applied. For FPGA devices, power-on conditions are simulated when global set/reset (GSR) is active. GSR defaults to active-High but can be inverted by adding an inverter in front of the GSR input of the appropriate *STARTUP_architecture* symbol.

Logic Table

Inputs		Outputs
D	C	Q
0	↓	0
1	↓	1

Design Entry Method

This design element is only for use in schematics.

For More Information

- See the [Spartan-3 Generation FPGA User Guide \(UG331\)](#).
- See the [Spartan-3E FPGA Family Data Sheet \(DS312\)](#).

IFDX

Macro: Input D Flip-Flop with Clock Enable

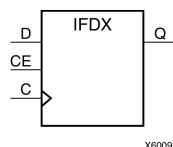

Introduction

This D-type flip-flop is contained in an input/output block (IOB). The input (D) of the flip-flop is connected to an IPAD or an IOPAD (without using an IBUF). The D input provides data input for the flip-flop, which synchronizes data entering the chip. When CE is High, the data on input D is loaded into the flip-flop during the Low-to-High clock (C) transition and appears at the output (Q). The clock input can be driven by internal logic or through another external pin. When CE is Low, flip-flop outputs do not change.

This flip-flop is asynchronously cleared, outputs Low, when power is applied. For FPGA devices, power-on conditions are simulated when global set/reset (GSR) is active. GSR defaults to active-High but can be inverted by adding an inverter in front of the GSR input of the appropriate `STARTUP_architecture` symbol.

Logic Table

Inputs			Outputs
CE	D	C	Q
1	D	↑	D
0	X	X	No Change

Design Entry Method

This design element is only for use in schematics.

For More Information

- See the [Spartan-3 Generation FPGA User Guide \(UG331\)](#).
- See the [Spartan-3E FPGA Family Data Sheet \(DS312\)](#).

IFDX_1

Macro: Input D Flip-Flop with Inverted Clock and Clock Enable

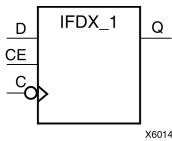

Introduction

This design element is a D-type flip-flop is contained in an input/output block (IOB). The input (D) of the flip-flop is connected to an IPAD or an IOPAD. The D input also provides data input for the flip-flop, which synchronizes data entering the chip. When CE is High, the data on input D is loaded into the flip-flop during the High-to-Low clock (C) transition and appears at the output (Q). The clock input can be driven by internal logic or through another external pin. When the CE pin is Low, the output (Q) does not change.

This flip-flop is asynchronously cleared, outputs Low, when power is applied. For FPGA devices, power-on conditions are simulated when global set/reset (GSR) is active. GSR defaults to active-High but can be inverted by adding an inverter in front of the GSR input of the appropriate *STARTUP_architecture* symbol.

Logic Table

Inputs			Outputs
CE	D	C	Q
1	D	↓	D
0	X	X	No Change

Design Entry Method

This design element is only for use in schematics.

For More Information

- See the [Spartan-3 Generation FPGA User Guide \(UG331\)](#).
- See the [Spartan-3E FPGA Family Data Sheet \(DS312\)](#).

IFDX16

Macro: 16-Bit Input D Flip-Flops with Clock Enable

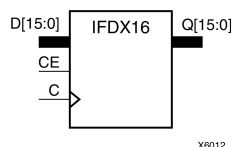

Introduction

This D-type flip-flop is contained in an input/output block (IOB). The input (D) of the flip-flop is connected to an IPAD or an IOPAD (without using an IBUF). The D input provides data input for the flip-flop, which synchronizes data entering the chip. When CE is High, the data on input D is loaded into the flip-flop during the Low-to-High clock (C) transition and appears at the output (Q). The clock input can be driven by internal logic or through another external pin. When CE is Low, flip-flop outputs do not change.

This flip-flop is asynchronously cleared, outputs Low, when power is applied. For FPGA devices, power-on conditions are simulated when global set/reset (GSR) is active. GSR defaults to active-High but can be inverted by adding an inverter in front of the GSR input of the appropriate `STARTUP_architecture` symbol.

Logic Table

Inputs			Outputs
CE	D	C	Q
1	D	↑	D
0	X	X	No Change

Design Entry Method

This design element is only for use in schematics.

For More Information

- See the [Spartan-3 Generation FPGA User Guide \(UG331\)](#).
- See the [Spartan-3E FPGA Family Data Sheet \(DS312\)](#).

IFDX4

Macro: 4-Bit Input D Flip-Flop with Clock Enable

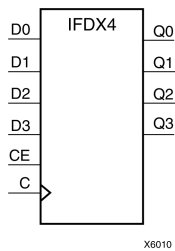

Introduction

This D-type flip-flop is contained in an input/output block (IOB). The input (D) of the flip-flop is connected to an IPAD or an IOPAD (without using an IBUF). The D input provides data input for the flip-flop, which synchronizes data entering the chip. When CE is High, the data on input D is loaded into the flip-flop during the Low-to-High clock (C) transition and appears at the output (Q). The clock input can be driven by internal logic or through another external pin. When CE is Low, flip-flop outputs do not change.

This flip-flop is asynchronously cleared, outputs Low, when power is applied. For FPGA devices, power-on conditions are simulated when global set/reset (GSR) is active. GSR defaults to active-High but can be inverted by adding an inverter in front of the GSR input of the appropriate `STARTUP_architecture` symbol.

Logic Table

Inputs			Outputs
CE	D	C	Q
1	D	↑	D
0	X	X	No Change

Design Entry Method

This design element is only for use in schematics.

For More Information

- See the [Spartan-3 Generation FPGA User Guide \(UG331\)](#).
- See the [Spartan-3E FPGA Family Data Sheet \(DS312\)](#).

IFDX8

Macro: 8-Bit Input D Flip-Flop with Clock Enable

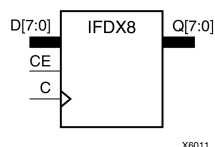

Introduction

This D-type flip-flop is contained in an input/output block (IOB). The input (D) of the flip-flop is connected to an IPAD or an IOPAD (without using an IBUF). The D input provides data input for the flip-flop, which synchronizes data entering the chip. When CE is High, the data on input D is loaded into the flip-flop during the Low-to-High clock (C) transition and appears at the output (Q). The clock input can be driven by internal logic or through another external pin. When CE is Low, flip-flop outputs do not change.

This flip-flop is asynchronously cleared, outputs Low, when power is applied. For FPGA devices, power-on conditions are simulated when global set/reset (GSR) is active. GSR defaults to active-High but can be inverted by adding an inverter in front of the GSR input of the appropriate `STARTUP_architecture` symbol.

Logic Table

Inputs			Outputs
CE	D	C	Q
1	D	↑	D
0	X	X	No Change

Design Entry Method

This design element is only for use in schematics.

For More Information

- See the [Spartan-3 Generation FPGA User Guide \(UG331\)](#).
- See the [Spartan-3E FPGA Family Data Sheet \(DS312\)](#).

IFDXI

Macro: Input D Flip-Flop with Clock Enable (Asynchronous Preset)

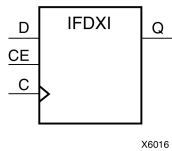

Introduction

The design element is a D-type flip-flop is contained in an input/output block (IOB). The input (D) of the flip-flop is connected to an IPAD or an IOPAD. The D input provides data input for the flip-flop, which synchronizes data entering the chip. When CE is High, the data on input D is loaded into the flip-flop during the Low-to-High clock (C) transition and appears at the output (Q). The clock input can be driven by internal logic or through another external pin. When the CE pin is Low, the output (Q) does not change.

This flip-flop is asynchronously cleared, outputs Low, when power is applied. For FPGA devices, power-on conditions are simulated when global set/reset (GSR) is active. GSR defaults to active-High but can be inverted by adding an inverter in front of the GSR input of the appropriate STARTUP_architecture symbol.

Logic Table

Inputs			Outputs
CE	D	C	Q
1	D	↑	D
0	X	X	No Change

Design Entry Method

This design element is only for use in schematics.

For More Information

- See the [Spartan-3 Generation FPGA User Guide \(UG331\)](#).
- See the [Spartan-3E FPGA Family Data Sheet \(DS312\)](#).

IFDXI_1

Macro: Input D Flip-Flop with Inverted Clock and Clock Enable (Asynchronous Preset)

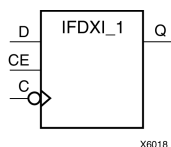

Introduction

The design element is a D-type flip-flop that is contained in an input/output block (IOB). The input (D) of the flip-flop is connected to an IPAD or an IOPAD. The (D) input provides data input for the flip-flop, which synchronizes data entering the chip. When (CE) is High, the data on input (D) is loaded into the flip-flop during the High-to-Low clock (C) transition and appears at the output (Q). The clock input can be driven by internal logic or through another external pin. When the (CE) pin is Low, the output (Q) does not change.

This flip-flop is asynchronously cleared, outputs Low, when power is applied. For FPGA devices, power-on conditions are simulated when global set/reset (GSR) is active. GSR defaults to active-High but can be inverted by adding an inverter in front of the GSR input of the appropriate `STARTUP_architecture` symbol.

Logic Table

Inputs			Outputs
CE	D	C	Q
1	D	↓	D
0	X	X	No Change

Design Entry Method

This design element is only for use in schematics.

For More Information

- See the [Spartan-3 Generation FPGA User Guide \(UG331\)](#).
- See the [Spartan-3E FPGA Family Data Sheet \(DS312\)](#).

ILD

Macro: Transparent Input Data Latch

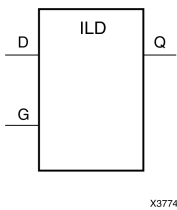

Introduction

This design element is a single, transparent data latch that holds transient data entering a chip. This latch is contained in an input/output block (IOB). The latch input (D) is connected to an IPAD or an IOPAD (without using an IBUF). When the gate input (G) is High, data on the input (D) appears on the output (Q). Data on the D input during the High-to-Low G transition is stored in the latch.

This latch is asynchronously cleared, outputs Low, when power is applied. For FPGA devices, power-on conditions are simulated when global set/reset (GSR) is active. GSR defaults to active-High but can be inverted by adding an inverter in front of the GSR input of the appropriate `STARTUP_architecture` symbol.

Logic Table

Inputs		Output
G	D	Q
1	D	D
0	X	No Change
↓	D	D

Design Entry Method

This design element is only for use in schematics.

For More Information

- See the [Spartan-3 Generation FPGA User Guide \(UG331\)](#).
- See the [Spartan-3E FPGA Family Data Sheet \(DS312\)](#).

ILD_1

Macro: Transparent Input Data Latch with Inverted Gate

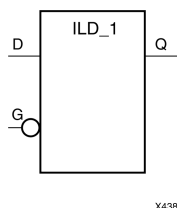

Introduction

This design element is a transparent data latch that holds transient data entering a chip. When the gate input (G) is Low, data on the data input (D) appears on the data output (Q). Data on (D) during the Low-to-High (G) transition is stored in the latch.

This latch is asynchronously cleared, outputs Low, when power is applied. For FPGA devices, power-on conditions are simulated when global set/reset (GSR) is active. GSR defaults to active-High but can be inverted by adding an inverter in front of the GSR input of the appropriate `STARTUP_architecture` symbol.

Logic Table

Inputs		Outputs
G	D	Q
0	D	D
1	X	No Change
↑	D	D

Design Entry Method

This design element is only for use in schematics.

For More Information

- See the [Spartan-3 Generation FPGA User Guide \(UG331\)](#).
- See the [Spartan-3E FPGA Family Data Sheet \(DS312\)](#).

ILD16

Macro: Transparent Input Data Latch

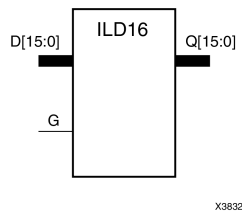

Introduction

These design elements are multiple transparent data latches that hold transient data entering a chip. The ILD latch is contained in an input/output block (IOB). The latch input (D) is connected to an IPAD or an IOPAD (without using an IBUF). When the gate input (G) is High, data on the inputs (D) appears on the outputs (Q). Data on the D inputs during the High-to-Low G transition is stored in the latch.

This latch is asynchronously cleared, outputs Low, when power is applied. For FPGA devices, power-on conditions are simulated when global set/reset (GSR) is active. GSR defaults to active-High but can be inverted by adding an inverter in front of the GSR input of the appropriate `STARTUP_architecture` symbol.

Logic Table

Inputs		Outputs
G	D	Q
1	Dn	Dn
0	X	No Change
↓	Dn	Dn

Design Entry Method

This design element is only for use in schematics.

For More Information

- See the [Spartan-3 Generation FPGA User Guide \(UG331\)](#).
- See the [Spartan-3E FPGA Family Data Sheet \(DS312\)](#).

ILD4

Macro: Transparent Input Data Latch

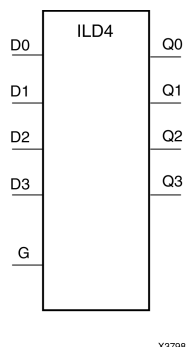

Introduction

These design elements are multiple transparent data latches that hold transient data entering a chip. The ILD latch is contained in an input/output block (IOB). The latch input (D) is connected to an IPAD or an IOPAD (without using an IBUF). When the gate input (G) is High, data on the inputs (D) appears on the outputs (Q). Data on the D inputs during the High-to-Low G transition is stored in the latch.

This latch is asynchronously cleared, outputs Low, when power is applied. For FPGA devices, power-on conditions are simulated when global set/reset (GSR) is active. GSR defaults to active-High but can be inverted by adding an inverter in front of the GSR input of the appropriate `STARTUP_architecture` symbol.

Logic Table

Inputs		Outputs
G	D	Q
1	Dn	Dn
0	X	No Change
↓	Dn	Dn

Design Entry Method

This design element is only for use in schematics.

For More Information

- See the [Spartan-3 Generation FPGA User Guide \(UG331\)](#).
- See the [Spartan-3E FPGA Family Data Sheet \(DS312\)](#).

ILD8

Macro: Transparent Input Data Latch

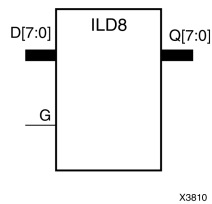

Introduction

These design elements are multiple transparent data latches that hold transient data entering a chip. The ILD latch is contained in an input/output block (IOB). The latch input (D) is connected to an IPAD or an IOPAD (without using an IBUF). When the gate input (G) is High, data on the inputs (D) appears on the outputs (Q). Data on the D inputs during the High-to-Low G transition is stored in the latch.

This latch is asynchronously cleared, outputs Low, when power is applied. For FPGA devices, power-on conditions are simulated when global set/reset (GSR) is active. GSR defaults to active-High but can be inverted by adding an inverter in front of the GSR input of the appropriate `STARTUP_architecture` symbol.

Logic Table

Inputs		Outputs
G	D	Q
1	D _n	D _n
0	X	No Change
↓	D _n	D _n

Design Entry Method

This design element is only for use in schematics.

For More Information

- See the [Spartan-3 Generation FPGA User Guide \(UG331\)](#).
- See the [Spartan-3E FPGA Family Data Sheet \(DS312\)](#).

ILDI

Macro: Transparent Input Data Latch (Asynchronous Preset)

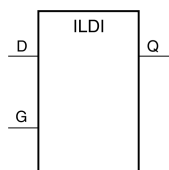

X4388

Introduction

This design element is a transparent data latch that holds transient data entering a chip. When the gate input (G) is High, data on the input (D) appears on the output (Q). Data on the D input during the High-to-Low G transition is stored in the latch.

The ILDI is the input flip-flop master latch. It is possible to access two different outputs from the input flip-flop: one that responds to the level of the clock signal and another that responds to an edge of the clock signal. When using both outputs from the same input flip-flop, a transparent High latch (ILDI) corresponds to a falling edge-triggered flip-flop (IFDI_1). Similarly, a transparent Low latch (ILDI_1) corresponds to a rising edge-triggered flip-flop (IFDI).

The latch is asynchronously preset, output High, when power is applied.

For FPGA devices, power-on conditions are simulated when global set/reset (GSR) is active. GSR defaults to active-High but can be inverted by adding an inverter in front of the GSR input of the appropriate `STARTUP_architecture` symbol.

Logic Table

Inputs		Outputs
G	D	Q
1	D	D
0	X	No Change
↓	D	D

Design Entry Method

This design element is only for use in schematics.

For More Information

- See the [Spartan-3 Generation FPGA User Guide \(UG331\)](#).
- See the [Spartan-3E FPGA Family Data Sheet \(DS312\)](#).

ILDI_1

Macro: Transparent Input Data Latch with Inverted Gate (Asynchronous Preset)

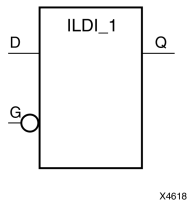

Introduction

This design element is a transparent data latch that holds transient data entering a chip. When the gate input (G) is Low, data on the data input (D) appears on the data output (Q). Data on D during the Low-to-High G transition is stored in the latch.

The latch is asynchronously preset, output High, when power is applied.

For FPGA devices, power-on conditions are simulated when global set/reset (GSR) is active. GSR defaults to active-High but can be inverted by adding an inverter in front of the GSR input of the appropriate `STARTUP_architecture` symbol.

Logic Table

Inputs		Outputs
G	D	Q
0	1	1
0	0	0
1	X	No Change
↑	D	D

Design Entry Method

This design element is only for use in schematics.

For More Information

- See the [Spartan-3 Generation FPGA User Guide \(UG331\)](#).
- See the [Spartan-3E FPGA Family Data Sheet \(DS312\)](#).

ILDX

Macro: Transparent Input Data Latch

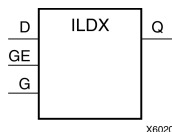

Introduction

This design element is single or multiple transparent data latches that holds transient data entering a chip. The latch input (D) is connected to an IPAD or an IOPAD (without using an IBUF).

The ILDX is the input flip-flop master latch. Two outputs can be accessed from the input flip-flop: one that responds to the level of the clock signal and another that responds to an edge of the clock signal. When using both outputs from the same input flip-flop, a transparent High latch (ILDX) corresponds to a falling edge-triggered flip-flop (IFDX_1). Similarly, a transparent Low latch (ILDX_1) corresponds to a rising edge-triggered flip-flop (IFDX)

This latch is asynchronously cleared, outputs Low, when power is applied. For FPGA devices, power-on conditions are simulated when global set/reset (GSR) is active. GSR defaults to active-High but can be inverted by adding an inverter in front of the GSR input of the appropriate `STARTUP_architecture` symbol.

Logic Table

Inputs			Outputs
GE	G	D	Q
0	X	X	No Change
1	0	X	No Change
1	1	1	1
1	1	0	0
1	↓	D	D

Design Entry Method

This design element is only for use in schematics.

For More Information

- See the [Spartan-3 Generation FPGA User Guide \(UG331\)](#).
- See the [Spartan-3E FPGA Family Data Sheet \(DS312\)](#).

ILDX_1

Macro: Transparent Input Data Latch with Inverted Gate

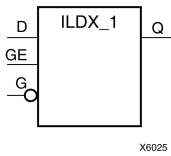

Introduction

This design element is a transparent data latch that holds transient data entering a chip. When the gate input (G) is Low, data on the data input (D) appears on the data output (Q). Data on D during the Low-to-High G transition is stored in the latch.

This latch is asynchronously cleared, outputs Low, when power is applied. For FPGA devices, power-on conditions are simulated when global set/reset (GSR) is active. GSR defaults to active-High but can be inverted by adding an inverter in front of the GSR input of the appropriate `STARTUP_architecture` symbol.

Logic Table

Inputs			Outputs
GE	G	D	Q
0	X	X	No Change
1	1	X	No Change
1	0	1	1
1	0	0	0
1	↑	D	D

Design Entry Method

This design element is only for use in schematics.

For More Information

- See the [Spartan-3 Generation FPGA User Guide \(UG331\)](#).
- See the [Spartan-3E FPGA Family Data Sheet \(DS312\)](#).

ILDX16

Macro: Transparent Input Data Latch

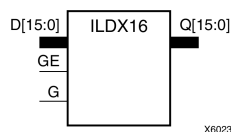

Introduction

This design element is single or multiple transparent data latches that holds transient data entering a chip. The latch input (D) is connected to an IPAD or an IOPAD (without using an IBUF).

The ILDX is the input flip-flop master latch. Two outputs can be accessed from the input flip-flop: one that responds to the level of the clock signal and another that responds to an edge of the clock signal. When using both outputs from the same input flip-flop, a transparent High latch (ILDX) corresponds to a falling edge-triggered flip-flop (IFDX_1). Similarly, a transparent Low latch (ILDX_1) corresponds to a rising edge-triggered flip-flop (IFDX)

This latch is asynchronously cleared, outputs Low, when power is applied. For FPGA devices, power-on conditions are simulated when global set/reset (GSR) is active. GSR defaults to active-High but can be inverted by adding an inverter in front of the GSR input of the appropriate `STARTUP_architecture` symbol.

Logic Table

Inputs			Outputs
GE	G	D	Q
0	X	X	No Change
1	0	X	No Change
1	1	Dn	Dn

Design Entry Method

This design element is only for use in schematics.

For More Information

- See the [Spartan-3 Generation FPGA User Guide \(UG331\)](#).
- See the [Spartan-3E FPGA Family Data Sheet \(DS312\)](#).

ILDX4

Macro: Transparent Input Data Latch

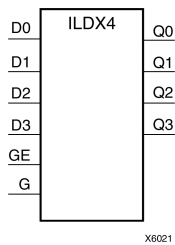

Introduction

This design element is single or multiple transparent data latches that holds transient data entering a chip. The latch input (D) is connected to an IPAD or an IOPAD (without using an IBUF).

The ILDX is the input flip-flop master latch. Two outputs can be accessed from the input flip-flop: one that responds to the level of the clock signal and another that responds to an edge of the clock signal. When using both outputs from the same input flip-flop, a transparent High latch (ILDX) corresponds to a falling edge-triggered flip-flop (IFDX_1). Similarly, a transparent Low latch (ILDX_1) corresponds to a rising edge-triggered flip-flop (IFDX)

This latch is asynchronously cleared, outputs Low, when power is applied. For FPGA devices, power-on conditions are simulated when global set/reset (GSR) is active. GSR defaults to active-High but can be inverted by adding an inverter in front of the GSR input of the appropriate STARTUP_architecture symbol.

Logic Table

Inputs			Outputs
GE	G	D	Q
0	X	X	No Change
1	1	X	No Change
1	0	1	1
1	0	0	0
1	↑	Dn	Dn

Design Entry Method

This design element is only for use in schematics.

For More Information

- See the [Spartan-3 Generation FPGA User Guide \(UG331\)](#).
- See the [Spartan-3E FPGA Family Data Sheet \(DS312\)](#).

ILDX8

Macro: Transparent Input Data Latch

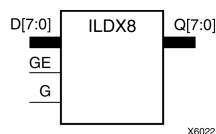

Introduction

This design element is single or multiple transparent data latches that holds transient data entering a chip. The latch input (D) is connected to an IPAD or an IOPAD (without using an IBUF).

The ILDX is the input flip-flop master latch. Two outputs can be accessed from the input flip-flop: one that responds to the level of the clock signal and another that responds to an edge of the clock signal. When using both outputs from the same input flip-flop, a transparent High latch (ILDX) corresponds to a falling edge-triggered flip-flop (IFDX_1). Similarly, a transparent Low latch (ILDX_1) corresponds to a rising edge-triggered flip-flop (IFDX).

This latch is asynchronously cleared, outputs Low, when power is applied. For FPGA devices, power-on conditions are simulated when global set/reset (GSR) is active. GSR defaults to active-High but can be inverted by adding an inverter in front of the GSR input of the appropriate *STARTUP_architecture* symbol.

Logic Table

Inputs			Outputs
GE	G	D	Q
0	X	X	No Change
1	0	X	No Change
1	1	Dn	Dn

Design Entry Method

This design element is only for use in schematics.

For More Information

- See the [Spartan-3 Generation FPGA User Guide \(UG331\)](#).
- See the [Spartan-3E FPGA Family Data Sheet \(DS312\)](#).

ILDXI

Macro: Transparent Input Data Latch (Asynchronous Preset)

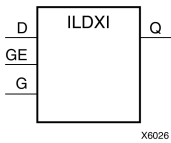

Introduction

This design element is a transparent data latch that holds transient data entering a chip. When the gate input (G) is High, data on the input (D) appears on the output (Q). Data on the (D) input during the High-to-Low (G) transition is stored in the latch.

The ILDXI is the input flip-flop master latch. Two outputs can be accessed from the input flip-flop: one that responds to the level of the clock signal and another that responds to an edge of the clock signal. When using both outputs from the same input flip-flop, a transparent High latch (ILDXI) corresponds to a falling edge-triggered flip-flop (IFDXI_1). Similarly, a transparent Low latch (ILDXI_1) corresponds to a rising edge-triggered flip-flop (IFDXI).

The latch is asynchronously preset, output High, when power is applied.

For FPGA devices, power-on conditions are simulated when global set/reset (GSR) is active. GSR defaults to active-High but can be inverted by adding an inverter in front of the GSR input of the appropriate *STARTUP_architecture* symbol.

Logic Table

Inputs			Outputs
GE	G	D	Q
0	X	X	No Change
1	0	X	No Change
1	1	D	D
1	↓	D	D

Design Entry Method

This design element is only for use in schematics.

For More Information

- See the [Spartan-3 Generation FPGA User Guide \(UG331\)](#).
- See the [Spartan-3E FPGA Family Data Sheet \(DS312\)](#).

ILDXI_1

Macro: Transparent Input Data Latch with Inverted Gate (Asynchronous Preset)

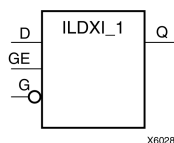

Introduction

This design element is a transparent data latch that holds transient data entering a chip.

The latch is asynchronously preset, output High, when power is applied.

For FPGA devices, power-on conditions are simulated when global set/reset (GSR) is active. GSR defaults to active-High but can be inverted by adding an inverter in front of the GSR input of the appropriate *STARTUP_architecture* symbol.

Logic Table

Inputs			Outputs
GE	G	D	Q
0	X	X	No Change
1	1	X	No Change
1	0	D	D
1	↑	D	D

Design Entry Method

This design element is only for use in schematics.

For More Information

- See the [Spartan-3 Generation FPGA User Guide \(UG331\)](#).
- See the [Spartan-3E FPGA Family Data Sheet \(DS312\)](#).

INV

Primitive: Inverter

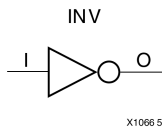

Introduction

This design element is a single inverter that identifies signal inversions in a schematic.

Design Entry Method

This design element is only for use in schematics.

For More Information

- See the [Spartan-3 Generation FPGA User Guide \(UG331\)](#).
- See the [Spartan-3E FPGA Family Data Sheet \(DS312\)](#).

INV16

Macro: 16 Inverters

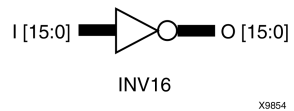

Introduction

This design element is a multiple inverter that identifies signal inversions in a schematic.

Design Entry Method

This design element is only for use in schematics.

For More Information

- See the [Spartan-3 Generation FPGA User Guide \(UG331\)](#).
- See the [Spartan-3E FPGA Family Data Sheet \(DS312\)](#).

INV4

Macro: Four Inverters

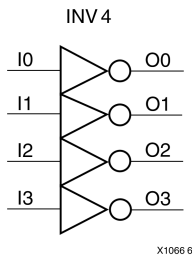

Introduction

This design element is a multiple inverter that identifies signal inversions in a schematic.

Design Entry Method

This design element is only for use in schematics.

For More Information

- See the [Spartan-3 Generation FPGA User Guide \(UG331\)](#).
- See the [Spartan-3E FPGA Family Data Sheet \(DS312\)](#).

INV8

Macro: Eight Inverters

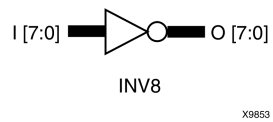

Introduction

This design element is a multiple inverter that identifies signal inversions in a schematic.

Design Entry Method

This design element is only for use in schematics.

For More Information

- See the [Spartan-3 Generation FPGA User Guide \(UG331\)](#).
- See the [Spartan-3E FPGA Family Data Sheet \(DS312\)](#).

IOBUF

Primitive: Bi-Directional Buffer

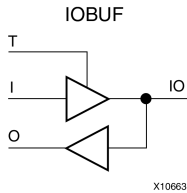

Introduction

The design element is a bidirectional single-ended I/O Buffer used to connect internal logic to an external bidirectional pin.

Logic Table

Inputs		Bidirectional	Outputs
T	I	IO	O
1	X	Z	IO
0	1	1	1
0	0	0	0

Port Descriptions

Port	Direction	Width	Function
O	Output	1	Buffer output
IO	Inout	1	Buffer inout
I	Input	1	Buffer input
T	Input	1	3-State enable input

Design Entry Method

This design element can be used in schematics.

Available Attributes

Attribute	Data Type	Allowed Values	Default	Description
DRIVE	Integer	2, 4, 6, 8, 12, 16, 24	12	Selects output drive strength (mA) for the SelectIO™ buffers that use the LVTTTL, LVCMOS12, LVCMOS15, LVCMOS18, LVCMOS25, or LVCMOS33 interface I/O standard.
IBUF_DELAY_VALUE	String	"0" through "12"	"0"	Specifies the amount of additional delay to add to the non-registered path out of the IOB
IFD_DELAY_VALUE	String	"AUTO", "0" through "6"	"AUTO"	Specifies the amount of additional delay to add to the registered path within the IOB

Attribute	Data Type	Allowed Values	Default	Description
IOSTANDARD	String	See Data Sheet	"DEFAULT"	Assigns an I/O standard to the element.
SLEW	String	"SLOW", "FAST", "QUIETIO"	"SLOW"	Sets the output rise and fall time. See the Data Sheet for recommendations of the best setting for this attribute.

For More Information

- See the [Spartan-3 Generation FPGA User Guide \(UG331\)](#).
- See the [Spartan-3E FPGA Family Data Sheet \(DS312\)](#).

IOBUFDS

Primitive: 3-State Differential Signaling I/O Buffer with Active Low Output Enable

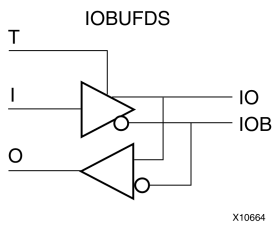

Introduction

The design element is a bidirectional buffer that supports low-voltage, differential signaling. For the IOBUFDS, a design level interface signal is represented as two distinct ports (IO and IOB), one deemed the "master" and the other the "slave." The master and the slave are opposite phases of the same logical signal (for example, MYNET_P and MYNET_N). Optionally, a programmable differential termination feature is available to help improve signal integrity and reduce external components. Also available is a programmable delay is to assist in the capturing of incoming data to the device.

Logic Table

Inputs		Bidirectional		Outputs
I	T	IO	IOB	O
X	1	Z	Z	No Change
0	0	0	1	0
1	0	1	0	1

Port Descriptions

Port	Direction	Width	Function
O	Output	1	Buffer output
IO	Inout	1	Diff_p inout
IOB	Inout	1	Diff_n inout
I	Input	1	Buffer input
T	Input	1	3-state enable input

Design Entry Method

This design element can be used in schematics.

Available Attributes

Attribute	Data Type	Allowed Values	Default	Description
IBUF_DELAY_VALUE	String	"0" through "12"	"0"	Specifies the amount of additional delay to add to the non-registered path out of the IOB
IFD_DELAY_VALUE	String	"AUTO", "0" through "6"	"AUTO"	Specifies the amount of additional delay to add to the registered path within the IOB
IOSTANDARD	String	See Data Sheet	"DEFAULT"	Assigns an I/O standard to the element.

For More Information

- See the [Spartan-3 Generation FPGA User Guide \(UG331\)](#).
- See the [Spartan-3E FPGA Family Data Sheet \(DS312\)](#).

KEEPER

Primitive: KEEPER Symbol

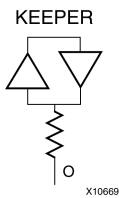

Introduction

The design element is a weak keeper element that retains the value of the net connected to its bidirectional O pin. For example, if a logic 1 is being driven onto the net, KEEPER drives a weak/resistive 1 onto the net. If the net driver is then 3-stated, KEEPER continues to drive a weak/resistive 1 onto the net.

Port Descriptions

Name	Direction	Width	Function
O	Output	1-Bit	Keeper output

Design Entry Method

This design element can be used in schematics or instantiated in HDL code. Instantiation templates for VHDL and Verilog are available below.

This element can be connected to a net in the following locations on a top-level schematic file:

- A net connected to an input IO Marker
- A net connected to both an output IO Marker and 3-statable IO element, such as an OBUFT.

For More Information

- See the [Spartan-3 Generation FPGA User Guide \(UG331\)](#).
- See the [Spartan-3E FPGA Family Data Sheet \(DS312\)](#).

LD

Primitive: Transparent Data Latch

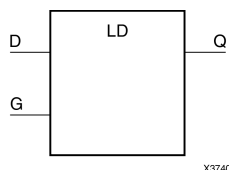

Introduction

LD is a transparent data latch. The data output (Q) of the latch reflects the data (D) input while the gate enable (G) input is High. The data on the (D) input during the High-to-Low gate transition is stored in the latch. The data on the (Q) output remains unchanged as long as (G) remains Low.

This latch is asynchronously cleared, outputs Low, when power is applied. For FPGA devices, power-on conditions are simulated when global set/reset (GSR) is active. GSR defaults to active-High but can be inverted by adding an inverter in front of the GSR input of the appropriate `STARTUP_architecture` symbol.

Logic Table

Inputs		Outputs
G	D	Q
1	D	D
0	X	No Change
↓	D	D

Design Entry Method

This design element is only for use in schematics.

Available Attributes

Attribute	Data Type	Allowed Values	Default	Description
INIT	Binary	0, 1	0	Sets the initial value of Q output after configuration

For More Information

- See the [Spartan-3 Generation FPGA User Guide \(UG331\)](#).
- See the [Spartan-3E FPGA Family Data Sheet \(DS312\)](#).

LD_1

Primitive: Transparent Data Latch with Inverted Gate

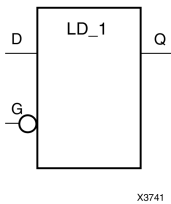

Introduction

This design element is a transparent data latch with an inverted gate. The data output (Q) of the latch reflects the data (D) input while the gate enable (G) input is Low. The data on the (D) input during the Low-to-High gate transition is stored in the latch. The data on the (Q) output remains unchanged as long as (G) remains High.

This latch is asynchronously cleared, outputs Low, when power is applied. For FPGA devices, power-on conditions are simulated when global set/reset (GSR) is active. GSR defaults to active-High but can be inverted by adding an inverter in front of the GSR input of the appropriate `STARTUP_architecture` symbol.

Logic Table

Inputs		Outputs
G	D	Q
0	D	D
1	X	No Change
↑	D	D

Design Entry Method

This design element is only for use in schematics.

Available Attributes

Attribute	Data Type	Allowed Values	Default	Description
INIT	Binary	0, 1	0	Sets the initial value of Q output after configuration.

For More Information

- See the [Spartan-3 Generation FPGA User Guide \(UG331\)](#).
- See the [Spartan-3E FPGA Family Data Sheet \(DS312\)](#).

LD16

Macro: Multiple Transparent Data Latch

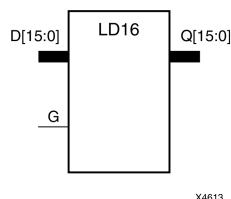

Introduction

This design element has 16 transparent data latches with a common gate enable (G). The data output (Q) of the latch reflects the data (D) input while the gate enable (G) input is High. The data on the (D) input during the High-to-Low gate transition is stored in the latch. The data on the (Q) output remains unchanged as long as (G) remains Low.

This latch is asynchronously cleared, outputs Low, when power is applied. For FPGA devices, power-on conditions are simulated when global set/reset (GSR) is active. GSR defaults to active-High but can be inverted by adding an inverter in front of the GSR input of the appropriate *STARTUP_architecture* symbol.

Logic Table

Inputs		Outputs
G	D	Q
1	Dn	Dn
0	X	No Change
↓	Dn	Dn

Design Entry Method

This design element is only for use in schematics.

Available Attributes

Attribute	Data Type	Allowed Values	Default	Description
INIT	Binary	Any 16-Bit Value	All zeros	Sets the initial value of Q output after configuration

For More Information

- See the [Spartan-3 Generation FPGA User Guide \(UG331\)](#).
- See the [Spartan-3E FPGA Family Data Sheet \(DS312\)](#).

LD16CE

Macro: Transparent Data Latch with Asynchronous Clear and Gate Enable

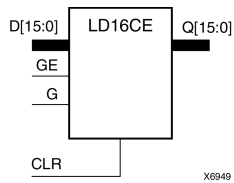

Introduction

This design element has 16 transparent data latches with asynchronous clear and gate enable. When the asynchronous clear input (CLR) is High, it overrides the other inputs and resets the data (Q) outputs Low. (Q) reflects the data (D) inputs while the gate (G) and gate enable (GE) are High, and (CLR) is Low. If (GE) is Low, data on (D) cannot be latched. The data on the (D) input during the High-to-Low gate transition is stored in the latch. The data on the (Q) output remains unchanged as long as (G) or (GE) remains Low.

This latch is asynchronously cleared, outputs Low, when power is applied. For FPGA devices, power-on conditions are simulated when global set/reset (GSR) is active. GSR defaults to active-High but can be inverted by adding an inverter in front of the GSR input of the appropriate STARTUP_architecture symbol.

Logic Table

Inputs				Outputs
CLR	GE	G	Dn	Qn
1	X	X	X	0
0	0	X	X	No Change
0	1	1	Dn	Dn
0	1	0	X	No Change
0	1	↓	Dn	Dn

Design Entry Method

This design element is only for use in schematics.

Available Attributes

Attribute	Data Type	Allowed Values	Default	Description
INIT	Binary	Any 16-Bit Value	All zeros	Sets the initial value of Q output after configuration

For More Information

- See the [Spartan-3 Generation FPGA User Guide \(UG331\)](#).
- See the [Spartan-3E FPGA Family Data Sheet \(DS312\)](#).

LD4

Macro: Multiple Transparent Data Latch

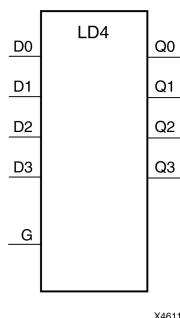

X4611

Introduction

This design element has four transparent data latches with a common gate enable (G). The data output (Q) of the latch reflects the data (D) input while the gate enable (G) input is High. The data on the (D) input during the High-to-Low gate transition is stored in the latch. The data on the (Q) output remains unchanged as long as (G) remains Low.

This latch is asynchronously cleared, outputs Low, when power is applied. For FPGA devices, power-on conditions are simulated when global set/reset (GSR) is active. GSR defaults to active-High but can be inverted by adding an inverter in front of the GSR input of the appropriate `STARTUP_architecture` symbol.

Logic Table

Inputs		Outputs
G	D	Q
1	Dn	Dn
0	X	No Change
↓	Dn	Dn

Design Entry Method

This design element is only for use in schematics.

Available Attributes

Attribute	Data Type	Allowed Values	Default	Description
INIT	Binary	Any 4-Bit Value	All zeros	Sets the initial value of Q output after configuration

For More Information

- See the [Spartan-3 Generation FPGA User Guide \(UG331\)](#).
- See the [Spartan-3E FPGA Family Data Sheet \(DS312\)](#).

LD4CE

Macro: Transparent Data Latch with Asynchronous Clear and Gate Enable

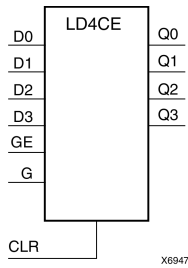

Introduction

This design element has 4 transparent data latches with asynchronous clear and gate enable. When the asynchronous element clear input (CLR) is High, it overrides the other inputs and resets the data (Q) outputs Low. (Q) reflects the data (D) inputs while the gate (G) and gate enable (GE) are High, and (CLR) is Low. If (GE) is Low, data on (D) cannot be latched. The data on the (D) input during the High-to-Low gate transition is stored in the latch. The data on the (Q) output remains unchanged as long as (G) or (GE) remains Low.

This latch is asynchronously cleared, outputs Low, when power is applied. For FPGA devices, power-on conditions are simulated when global set/reset (GSR) is active. GSR defaults to active-High but can be inverted by adding an inverter in front of the GSR input of the appropriate STARTUP_architecture symbol.

Logic Table

Inputs				Outputs
CLR	GE	G	Dn	Qn
1	X	X	X	0
0	0	X	X	No Change
0	1	1	Dn	Dn
0	1	0	X	No Change
0	1	↓	Dn	Dn

Design Entry Method

This design element is only for use in schematics.

Available Attributes

Attribute	Data Type	Allowed Values	Default	Description
INIT	Binary	Any 4-Bit Value	All zeros	Sets the initial value of Q output after configuration

For More Information

- See the [Spartan-3 Generation FPGA User Guide \(UG331\)](#).
- See the [Spartan-3E FPGA Family Data Sheet \(DS312\)](#).

LD8

Macro: Multiple Transparent Data Latch

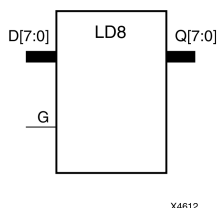

Introduction

This design element has 8 transparent data latches with a common gate enable (G). The data output (Q) of the latch reflects the data (D) input while the gate enable (G) input is High. The data on the (D) input during the High-to-Low gate transition is stored in the latch. The data on the (Q) output remains unchanged as long as (G) remains Low.

This latch is asynchronously cleared, outputs Low, when power is applied. For FPGA devices, power-on conditions are simulated when global set/reset (GSR) is active. GSR defaults to active-High but can be inverted by adding an inverter in front of the GSR input of the appropriate `STARTUP_architecture` symbol.

Logic Table

Inputs		Outputs
G	D	Q
1	Dn	Dn
0	X	No Change
↓	Dn	Dn

Design Entry Method

This design element is only for use in schematics.

Available Attributes

Attribute	Data Type	Allowed Values	Default	Description
INIT	Binary	Any 8-Bit Value	All zeros	Sets the initial value of Q output after configuration

For More Information

- See the [Spartan-3 Generation FPGA User Guide \(UG331\)](#).
- See the [Spartan-3E FPGA Family Data Sheet \(DS312\)](#).

LD8CE

Macro: Transparent Data Latch with Asynchronous Clear and Gate Enable

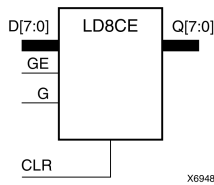

Introduction

This design element has 8 transparent data latches with asynchronous clear and gate enable. When the asynchronous clear input (CLR) is High, it overrides the other inputs and resets the data (Q) outputs Low. (Q) reflects the data (D) inputs while the gate (G) and gate enable (GE) are High, and (CLR) is Low. If (GE) is Low, data on (D) cannot be latched. The data on the (D) input during the High-to-Low gate transition is stored in the latch. The data on the (Q) output remains unchanged as long as (G) or (GE) remains Low.

This latch is asynchronously cleared, outputs Low, when power is applied. For FPGA devices, power-on conditions are simulated when global set/reset (GSR) is active. GSR defaults to active-High but can be inverted by adding an inverter in front of the GSR input of the appropriate STARTUP_architecture symbol.

Logic Table

Inputs				Outputs
CLR	GE	G	Dn	Qn
1	X	X	X	0
0	0	X	X	No Change
0	1	1	Dn	Dn
0	1	0	X	No Change
0	1	↓	Dn	Dn

Design Entry Method

This design element is only for use in schematics.

Available Attributes

Attribute	Data Type	Allowed Values	Default	Description
INIT	Binary	Any 8-Bit Value	All zeros	Sets the initial value of Q output after configuration.

For More Information

- See the [Spartan-3 Generation FPGA User Guide \(UG331\)](#).
- See the [Spartan-3E FPGA Family Data Sheet \(DS312\)](#).

LDC

Primitive: Transparent Data Latch with Asynchronous Clear

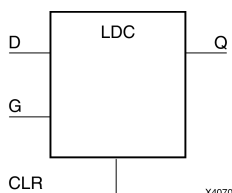

Introduction

This design element is a transparent data latch with asynchronous clear. When the asynchronous clear input (CLR) is High, it overrides the other inputs and resets the data (Q) output Low. (Q) reflects the data (D) input while the gate enable (G) input is High and (CLR) is Low. The data on the (D) input during the High-to-Low gate transition is stored in the latch. The data on the (Q) output remains unchanged as long as (G) remains low.

This latch is asynchronously cleared, outputs Low, when power is applied. For FPGA devices, power-on conditions are simulated when global set/reset (GSR) is active. GSR defaults to active-High but can be inverted by adding an inverter in front of the GSR input of the appropriate `STARTUP_architecture` symbol.

Logic Table

Inputs			Outputs
CLR	G	D	Q
1	X	X	0
0	1	D	D
0	0	X	No Change
0	↓	D	D

Design Entry Method

This design element is only for use in schematics.

Available Attributes

Attribute	Data Type	Allowed Values	Default	Description
INIT	Binary	0, 1	0	Sets the initial value of Q output after configuration.

For More Information

- See the [Spartan-3 Generation FPGA User Guide \(UG331\)](#).
- See the [Spartan-3E FPGA Family Data Sheet \(DS312\)](#).

LDC_1

Primitive: Transparent Data Latch with Asynchronous Clear and Inverted Gate

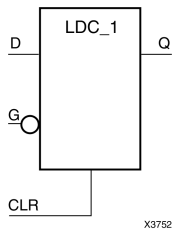

Introduction

This design element is a transparent data latch with asynchronous clear and inverted gate. When the asynchronous clear input (CLR) is High, it overrides the other inputs (D and G) and resets the data (Q) output Low. (Q) reflects the data (D) input while the gate enable (G) input and CLR are Low. The data on the (D) input during the Low-to-High gate transition is stored in the latch. The data on the (Q) output remains unchanged as long as (G) remains High.

This latch is asynchronously cleared, outputs Low, when power is applied. For FPGA devices, power-on conditions are simulated when global set/reset (GSR) is active. GSR defaults to active-High but can be inverted by adding an inverter in front of the GSR input of the appropriate STARTUP_architecture symbol.

Logic Table

Inputs			Outputs
CLR	G	D	Q
1	X	X	0
0	0	D	D
0	1	X	No Change
0	↑	D	D

Design Entry Method

This design element is only for use in schematics.

Available Attributes

Attribute	Data Type	Allowed Values	Default	Description
INIT	Binary	0, 1	0	Sets the initial value of Q output after configuration.

For More Information

- See the [Spartan-3 Generation FPGA User Guide \(UG331\)](#).
- See the [Spartan-3E FPGA Family Data Sheet \(DS312\)](#).

LDCE

Primitive: Transparent Data Latch with Asynchronous Clear and Gate Enable

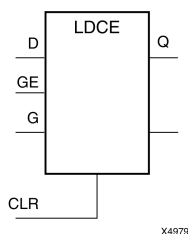

Introduction

This design element is a transparent data latch with asynchronous clear and gate enable. When the asynchronous clear input (CLR) is High, it overrides the other inputs and resets the data (Q) output Low. Q reflects the data (D) input while the gate (G) input and gate enable (GE) are High and CLR is Low. If (GE) is Low, data on (D) cannot be latched. The data on the (D) input during the High-to-Low gate transition is stored in the latch. The data on the (Q) output remains unchanged as long as (G) or (GE) remains low.

This latch is asynchronously cleared, outputs Low, when power is applied. For FPGA devices, power-on conditions are simulated when global set/reset (GSR) is active. GSR defaults to active-High but can be inverted by adding an inverter in front of the GSR input of the appropriate `STARTUP_architecture` symbol.

Logic Table

Inputs				Outputs
CLR	GE	G	D	Q
1	X	X	X	0
0	0	X	X	No Change
0	1	1	D	D
0	1	0	X	No Change
0	1	↓	D	D

Design Entry Method

This design element can be used in schematics.

Available Attributes

Attribute	Data Type	Allowed Values	Default	Description
INIT	Binary	0, 1	0	Sets the initial value of Q output after configuration.

For More Information

- See the [Spartan-3 Generation FPGA User Guide \(UG331\)](#).
- See the [Spartan-3E FPGA Family Data Sheet \(DS312\)](#).

LDCE_1

Primitive: Transparent Data Latch with Asynchronous Clear, Gate Enable, and Inverted Gate

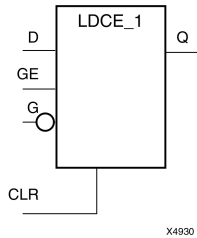

Introduction

This design element is a transparent data latch with asynchronous clear, gate enable, and inverted gate. When the asynchronous clear input (CLR) is High, it overrides the other inputs and resets the data (Q) output Low. (Q) reflects the data (D) input while the gate (G) input and (CLR) are Low and gate enable (GE) is High. The data on the (D) input during the Low-to-High gate transition is stored in the latch. The data on the (Q) output remains unchanged as long as (G) remains High or (GE) remains Low

This latch is asynchronously cleared, outputs Low, when power is applied. For FPGA devices, power-on conditions are simulated when global set/reset (GSR) is active. GSR defaults to active-High but can be inverted by adding an inverter in front of the GSR input of the appropriate *STARTUP_architecture* symbol.

Logic Table

Inputs				Outputs
CLR	GE	G	D	Q
1	X	X	X	0
0	0	X	X	No Change
0	1	0	D	D
0	1	1	X	No Change
0	1	↑	D	D

Design Entry Method

This design element is only for use in schematics.

Available Attributes

Attribute	Data Type	Allowed Values	Default	Description
INIT	Binary	0, 1	0	Sets the initial value of Q output after configuration.

For More Information

- See the [Spartan-3 Generation FPGA User Guide \(UG331\)](#).
- See the [Spartan-3E FPGA Family Data Sheet \(DS312\)](#).

LDCP

Primitive: Transparent Data Latch with Asynchronous Clear and Preset

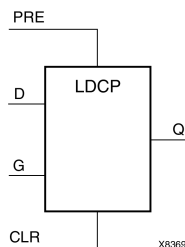

Introduction

The design element is a transparent data latch with data (D), asynchronous clear (CLR) and preset (PRE) inputs. When CLR is High, it overrides the other inputs and resets the data (Q) output Low. When PRE is High and CLR is low, it presets the data (Q) output High. Q reflects the data (D) input while the gate (G) input is High and CLR and PRE are Low. The data on the D input during the High-to-Low gate transition is stored in the latch. The data on the Q output remains unchanged as long as G remains Low.

This latch is asynchronously cleared, outputs Low, when power is applied. For FPGA devices, power-on conditions are simulated when global set/reset (GSR) is active. GSR defaults to active-High but can be inverted by adding an inverter in front of the GSR input of the appropriate `STARTUP_architecture` symbol.

Logic Table

Inputs				Outputs
CLR	PRE	G	D	Q
1	X	X	X	0
0	1	X	X	1
0	0	1	D	D
0	0	0	X	No Change
0	0	↓	D	D

Design Entry Method

This design element is only for use in schematics.

Available Attributes

Attribute	Data Type	Allowed Values	Default	Description
INIT	Integer	0, 1	0	Specifies the initial value upon power-up or the assertion of GSR for the (Q) port.

For More Information

- See the [Spartan-3 Generation FPGA User Guide \(UG331\)](#).
- See the [Spartan-3E FPGA Family Data Sheet \(DS312\)](#).

LDCP_1

Primitive: Transparent Data Latch with Asynchronous Clear and Preset and Inverted Gate

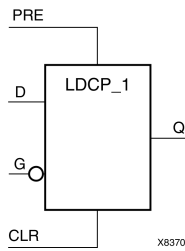

Introduction

This design element is a transparent data latch with data (D), asynchronous clear (CLR), preset (PRE) inputs, and inverted gate (G). When (CLR) is High, it overrides the other inputs and resets the data (Q) output Low. When (PRE) is High and (CLR) is Low, it presets the data (Q) output High. (Q) reflects the data (D) input while gate (G) input, (CLR), and (PRE) are Low. The data on the (D) input during the Low-to-High gate transition is stored in the latch. The data on the (Q) output remains unchanged as long as (G) remains High.

This latch is asynchronously cleared, outputs Low, when power is applied. For FPGA devices, power-on conditions are simulated when global set/reset (GSR) is active. GSR defaults to active-High but can be inverted by adding an inverter in front of the GSR input of the appropriate `STARTUP_architecture` symbol.

Logic Table

Inputs				Outputs
CLR	PRE	G	D	Q
1	X	X	X	0
0	1	X	X	1
0	0	0	D	D
0	0	1	X	No Change
0	0	↑	D	D

Design Entry Method

This design element is only for use in schematics.

Available Attributes

Attribute	Data Type	Allowed Values	Default	Description
INIT	Integer	0, 1	0	Specifies the initial value upon power-up or the assertion of GSR for the (Q) port.

For More Information

- See the [Spartan-3 Generation FPGA User Guide \(UG331\)](#).
- See the [Spartan-3E FPGA Family Data Sheet \(DS312\)](#).

LDCPE

Primitive: Transparent Data Latch with Asynchronous Clear and Preset and Gate Enable

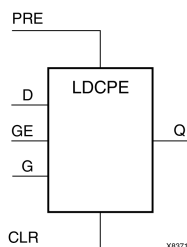

Introduction

This design element is a transparent data latch with data (D), asynchronous clear (CLR), asynchronous preset (PRE), and gate enable (GE). When (CLR) is High, it overrides the other inputs and resets the data (Q) output Low. When (PRE) is High and (CLR) is Low, it presets the data (Q) output High. Q reflects the data (D) input while the gate (G) input and gate enable (GE) are High and (CLR) and PRE are Low. The data on the (D) input during the High-to-Low gate transition is stored in the latch. The data on the Q output remains unchanged as long as (G) or (GE) remains Low.

This latch is asynchronously cleared, outputs Low, when power is applied. For FPGA devices, power-on conditions are simulated when global set/reset (GSR) is active. GSR defaults to active-High but can be inverted by adding an inverter in front of the GSR input of the appropriate `STARTUP_architecture` symbol.

Logic Table

Inputs					Outputs
CLR	PRE	GE	G	D	Q
1	X	X	X	X	0
0	1	X	X	X	1
0	0	0	X	X	No Change
0	0	1	1	0	0
0	0	1	1	1	1
0	0	1	0	X	No Change
0	0	1	↓	D	D

Port Descriptions

Port	Direction	Width	Function
Q	Output	1	Data Output
CLR	Input	1	Asynchronous clear/reset input
D	Input	1	Data Input
G	Input	1	Gate Input
GE	Input	1	Gate Enable Input
PRE	Input	1	Asynchronous preset/set input

Design Entry Method

This design element can be used in schematics.

Available Attributes

Attribute	Data Type	Allowed Values	Default	Description
INIT	Integer	0, 1	0	Sets the initial value of Q output after configuration.

For More Information

- See the [Spartan-3 Generation FPGA User Guide \(UG331\)](#).
- See the [Spartan-3E FPGA Family Data Sheet \(DS312\)](#).

LDCPE_1

Primitive: Transparent Data Latch with Asynchronous Clear and Preset, Gate Enable, and Inverted Gate

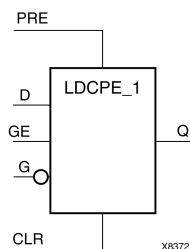

Introduction

This design element is a transparent data latch with data (D), asynchronous clear (CLR), asynchronous preset (PRE), gate enable (GE), and inverted gate (G). When (CLR) is High, it overrides the other inputs and resets the data (Q) output Low. When PRE is High and (CLR) is Low, it presets the data (Q) output High. (Q) reflects the data (D) input while gate enable (GE) is High and gate (G), (CLR), and (PRE) are Low. The data on the (D) input during the Low-to-High gate transition is stored in the latch. The data on the (Q) output remains unchanged as long as (G) is High or (GE) is Low.

This latch is asynchronously cleared, outputs Low, when power is applied. For FPGA devices, power-on conditions are simulated when global set/reset (GSR) is active. GSR defaults to active-High but can be inverted by adding an inverter in front of the GSR input of the appropriate `STARTUP_architecture` symbol.

Logic Table

Inputs					Outputs
CLR	PRE	GE	G	D	Q
1	X	X	X	X	0
0	1	X	X	X	1
0	0	0	X	X	No Change
0	0	1	0	D	D
0	0	1	1	X	No Change
0	0	1	↑	D	D

Design Entry Method

This design element is only for use in schematics.

Available Attributes

Attribute	Data Type	Allowed Values	Default	Description
INIT	Integer	0, 1	0	Specifies the initial value upon power-up or the assertion of GSR for the (Q) port.

For More Information

- See the [Spartan-3 Generation FPGA User Guide \(UG331\)](#).
- See the [Spartan-3E FPGA Family Data Sheet \(DS312\)](#).

LDE

Primitive: Transparent Data Latch with Gate Enable

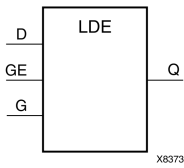

Introduction

This design element is a transparent data latch with data (D) and gate enable (GE) inputs. Output (Q) reflects the data (D) while the gate (G) input and gate enable (GE) are High. The data on the (D) input during the High-to-Low gate transition is stored in the latch. The data on the (Q) output remains unchanged as long as (G) or (GE) remains Low.

This latch is asynchronously cleared, outputs Low, when power is applied. For FPGA devices, power-on conditions are simulated when global set/reset (GSR) is active. GSR defaults to active-High but can be inverted by adding an inverter in front of the GSR input of the appropriate `STARTUP_architecture` symbol.

Logic Table

Inputs			Outputs
GE	G	D	Q
0	X	X	No Change
1	1	D	D
1	0	X	No Change
1	↓	D	D

Design Entry Method

This design element is only for use in schematics.

Available Attributes

Attribute	Data Type	Allowed Values	Default	Description
INIT	Binary	0, 1	0	Specifies the initial value upon power-up or the assertion of GSR for the (Q) port.

For More Information

- See the [Spartan-3 Generation FPGA User Guide \(UG331\)](#).
- See the [Spartan-3E FPGA Family Data Sheet \(DS312\)](#).

LDE_1

Primitive: Transparent Data Latch with Gate Enable and Inverted Gate

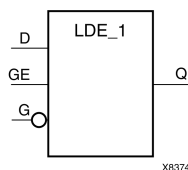

Introduction

This design element is a transparent data latch with data (D), gate enable (GE), and inverted gate (G). Output (Q) reflects the data (D) while the gate (G) input is Low and gate enable (GE) is High. The data on the (D) input during the Low-to-High gate transition is stored in the latch. The data on the (Q) output remains unchanged as long as (G) is High or (GE) is Low.

This latch is asynchronously cleared, outputs Low, when power is applied. For FPGA devices, power-on conditions are simulated when global set/reset (GSR) is active. GSR defaults to active-High but can be inverted by adding an inverter in front of the GSR input of the appropriate `STARTUP_architecture` symbol.

Logic Table

Inputs			Outputs
GE	G	D	Q
0	X	X	No Change
1	0	D	D
1	1	X	No Change
1	↑	D	D

Design Entry Method

This design element is only for use in schematics.

Available Attributes

Attribute	Data Type	Allowed Values	Default	Description
INIT	Binary	0, 1	0	Specifies the initial value upon power-up or the assertion of GSR for the (Q) port.

For More Information

- See the [Spartan-3 Generation FPGA User Guide \(UG331\)](#).
- See the [Spartan-3E FPGA Family Data Sheet \(DS312\)](#).

LDP

Primitive: Transparent Data Latch with Asynchronous Preset

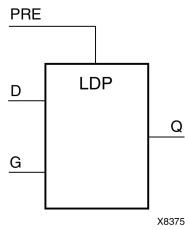

Introduction

This design element is a transparent data latch with asynchronous preset (PRE). When PRE is High it overrides the other inputs and presets the data (Q) output High. Q reflects the data (D) input while gate (G) input is High and PRE is Low. The data on the (D) input during the High-to-Low gate transition is stored in the latch. The data on the Q output remains unchanged as long as G remains Low.

The latch is asynchronously preset, output High, when power is applied. For FPGA devices, power-on conditions are simulated when global set/reset (GSR) is active. GSR defaults to active-High but can be inverted by adding an inverter in front of the GSR input of the appropriate STARTUP_architecture symbol.

Logic Table

Inputs			Outputs
PRE	G	D	Q
1	X	X	1
0	1	0	0
0	1	1	1
0	0	X	No Change
0	↓	D	D

Design Entry Method

This design element is only for use in schematics.

Available Attributes

Attribute	Data Type	Allowed Values	Default	Description
INIT	Binary	0, 1	1	Specifies the initial value upon power-up or the assertion of GSR for the Q port.

For More Information

- See the [Spartan-3 Generation FPGA User Guide \(UG331\)](#).
- See the [Spartan-3E FPGA Family Data Sheet \(DS312\)](#).

LDP_1

Primitive: Transparent Data Latch with Asynchronous Preset and Inverted Gate

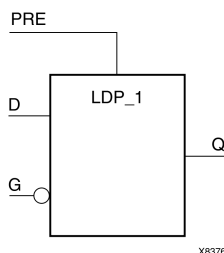

Introduction

This design element is a transparent data latch with asynchronous preset (PRE) and inverted gate (G). When the (PRE) input is High, it overrides the other inputs and presets the data (Q) output High. (Q) reflects the data (D) input while gate (G) input and (PRE) are Low. The data on the (D) input during the Low-to-High gate transition is stored in the latch. The data on the (Q) output remains unchanged as long as (G) remains High.

The latch is asynchronously preset, output High, when power is applied. For FPGA devices, power-on conditions are simulated when global set/reset (GSR) is active. GSR defaults to active-High but can be inverted by adding an inverter in front of the GSR input of the appropriate `STARTUP_architecture` symbol.

Logic Table

Inputs			Outputs
PRE	G	D	Q
1	X	X	1
0	0	D	D
0	1	X	No Change
0	↑	D	D

Design Entry Method

This design element is only for use in schematics.

Available Attributes

Attribute	Data Type	Allowed Values	Default	Description
INIT	Binary	0, 1	1	Specifies the initial value upon power-up or the assertion of GSR for the (Q) port.

For More Information

- See the [Spartan-3 Generation FPGA User Guide \(UG331\)](#).
- See the [Spartan-3E FPGA Family Data Sheet \(DS312\)](#).

LDPE

Primitive: Transparent Data Latch with Asynchronous Preset and Gate Enable

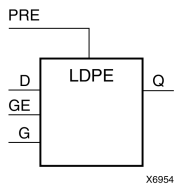

Introduction

This design element is a transparent data latch with asynchronous preset and gate enable. When the asynchronous preset (PRE) is High, it overrides the other input and presets the data (Q) output High. Q reflects the data (D) input while the gate (G) input and gate enable (GE) are High. The data on the (D) input during the High-to-Low gate transition is stored in the latch. The data on the (Q) output remains unchanged as long as (G) or (GE) remains Low.

The latch is asynchronously preset, output High, when power is applied. For FPGA devices, power-on conditions are simulated when global set/reset (GSR) is active. GSR defaults to active-High but can be inverted by adding an inverter in front of the GSR input of the appropriate *STARTUP_architecture* symbol.

Logic Table

Inputs				Outputs
PRE	GE	G	D	Q
1	X	X	X	1
0	0	X	X	No Change
0	1	1	D	D
0	1	0	X	No Change
0	1	↓	D	D

Design Entry Method

This design element can be used in schematics.

Available Attributes

Attribute	Data Type	Allowed Values	Default	Description
INIT	Binary	0, 1	1	Specifies the initial value upon power-up or the assertion of GSR for the (Q) port.

For More Information

- See the [Spartan-3 Generation FPGA User Guide \(UG331\)](#).
- See the [Spartan-3E FPGA Family Data Sheet \(DS312\)](#).

LDPE_1

Primitive: Transparent Data Latch with Asynchronous Preset, Gate Enable, and Inverted Gate

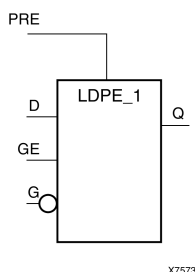

Introduction

This design element is a transparent data latch with asynchronous preset, gate enable, and inverted gate. When the asynchronous preset (PRE) is High, it overrides the other input and presets the data (Q) output High. (Q) reflects the data (D) input while the gate (G) and (PRE) are Low and gate enable (GE) is High. The data on the (D) input during the Low-to-High gate transition is stored in the latch. The data on the (Q) output remains unchanged as long as (G) remains High or (GE) remains Low.

The latch is asynchronously preset, output High, when power is applied. For FPGA devices, power-on conditions are simulated when global set/reset (GSR) is active. GSR defaults to active-High but can be inverted by adding an inverter in front of the GSR input of the appropriate `STARTUP_architecture` symbol.

Logic Table

Inputs				Outputs
PRE	GE	G	D	Q
1	X	X	X	1
0	0	X	X	No Change
0	1	0	D	D
0	1	1	X	No Change
0	1	↑	D	D

Design Entry Method

This design element is only for use in schematics.

Available Attributes

Attribute	Data Type	Allowed Values	Default	Description
INIT	Binary	0, 1	1	Specifies the initial value upon power-up or the assertion of GSR for the (Q) port.

For More Information

- See the [Spartan-3 Generation FPGA User Guide \(UG331\)](#).
- See the [Spartan-3E FPGA Family Data Sheet \(DS312\)](#).

LUT1

Primitive: 1-Bit Look-Up Table with General Output

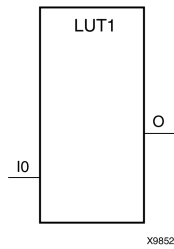

Introduction

This design element is a 1-bit look-up table (LUT) with general output (O).

An INIT attribute with an appropriate number of hexadecimal digits for the number of inputs must be attached to the LUT to specify its function. This element provides a look-up table version of a buffer or inverter. These elements are the basic building blocks. Two LUTs are available in each CLB slice; four LUTs are available in each CLB. Multiple variants of LUTs accommodate additional types of outputs that can be used by different timing models for more accurate pre-layout timing estimation.

The INIT parameter for the FPGA LUT primitive is what gives the LUT its logical value. By default, this value is zero, thus driving the output to a zero regardless of the input values (acting as a ground). However, in most cases a new INIT value must be determined in order to specify the logic function for the LUT primitive. There are at least two methods by which the LUT value can be determined:

The Logic Table Method -A common method to determine the desired INIT value for a LUT is using a logic table. To do so, simply create a binary logic table of all possible inputs, specify the desired logic value of the output and then create the INIT string from those output values.

The Equation Method -Another method to determine the LUT value is to define parameters for each input to the LUT that correspond to their listed truth value and use those to build the logic equation you are after. This method is easier to understand once you have grasped the concept and is more self-documenting than the above method. However, this method does require the code to first specify the appropriate parameters.

Logic Table

Inputs	Outputs
I0	O
0	INIT[0]
1	INIT[1]
INIT = Binary number assigned to the INIT attribute	

Design Entry Method

This design element can be used in schematics.

Available Attributes

Attribute	Data Type	Allowed Values	Default	Description
INIT	Hexadecimal	Any 2-Bit Value	All zeros	Initializes look-up tables.

For More Information

- See the [Spartan-3 Generation FPGA User Guide \(UG331\)](#).
- See the [Spartan-3E FPGA Family Data Sheet \(DS312\)](#).

LUT1_D

Primitive: 1-Bit Look-Up Table with Dual Output

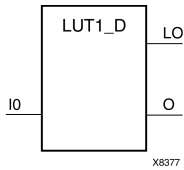

Introduction

This design element is a 1-bit look-up table (LUT) with two functionally identical outputs, O and LO. It provides a look-up table version of a buffer or inverter.

The O output is a general interconnect. The LO output is used to connect to another input within the same CLB slice and to the fast connect buffer. A mandatory INIT attribute, with an appropriate number of hexadecimal digits for the number of inputs, must be attached to the LUT to specify its function.

The INIT parameter for the FPGA LUT primitive is what gives the LUT its logical value. By default, this value is zero, thus driving the output to a zero regardless of the input values (acting as a ground). However, in most cases a new INIT value must be determined in order to specify the logic function for the LUT primitive. There are at least two methods by which the LUT value can be determined:

- **The Logic Table Method** -A common method to determine the desired INIT value for a LUT is using a logic table. To do so, simply create a binary logic table of all possible inputs, specify the desired logic value of the output and then create the INIT string from those output values.
- **The Equation Method** -Another method to determine the LUT value is to define parameters for each input to the LUT that correspond to their listed truth value and use those to build the logic equation. This method is easier to understand once you have grasped the concept and is more self-documenting than the above method. However, this method does require the code to first specify the appropriate parameters.

Logic Table

Inputs	Outputs	
I0	O	LO
0	INIT[0]	INIT[0]
1	INIT[1]	INIT[1]
INIT = Binary number assigned to the INIT attribute		

Design Entry Method

This design element can be used in schematics.

Available Attributes

Attribute	Data Type	Allowed Values	Default	Description
INIT	Hexadecimal	Any 2-Bit Value	All zeros	Initializes look-up tables.

For More Information

- See the [Spartan-3 Generation FPGA User Guide \(UG331\)](#).
- See the [Spartan-3E FPGA Family Data Sheet \(DS312\)](#).

LUT1_L

Primitive: 1-Bit Look-Up Table with Local Output

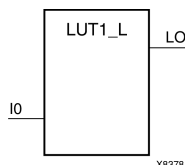

Introduction

This design element is a 1-bit look-up table (LUT) with a local output (LO) that is used to connect to another output within the same CLB slice and to the fast connect buffer. It provides a look-up table version of a buffer or inverter.

A mandatory INIT attribute, with an appropriate number of hexadecimal digits for the number of inputs, must be attached to the LUT to specify its function.

The INIT parameter for the FPGA LUT primitive is what gives the LUT its logical value. By default, this value is zero, thus driving the output to a zero regardless of the input values (acting as a ground). However, in most cases a new INIT value must be determined in order to specify the logic function for the LUT primitive. There are at least two methods by which the LUT value can be determined:

The Logic Table Method -A common method to determine the desired INIT value for a LUT is using a logic table. To do so, simply create a binary logic table of all possible inputs, specify the desired logic value of the output and then create the INIT string from those output values.

The Equation Method -Another method to determine the LUT value is to define parameters for each input to the LUT that correspond to their listed truth value and use those to build the logic equation you are after. This method is easier to understand once you have grasped the concept and is more self-documenting than the above method. However, this method does require the code to first specify the appropriate parameters.

Logic Table

Inputs	Outputs
I0	LO
0	INIT[0]
1	INIT[1]
INIT = Binary number assigned to the INIT attribute	

Design Entry Method

This design element can be used in schematics.

Available Attributes

Attribute	Data Type	Allowed Values	Default	Description
INIT	Hexadecimal	Any 2-Bit Value	All zeros	Initializes look-up tables.

For More Information

- See the [Spartan-3 Generation FPGA User Guide \(UG331\)](#).
- See the [Spartan-3E FPGA Family Data Sheet \(DS312\)](#).

LUT2

Primitive: 2-Bit Look-Up Table with General Output

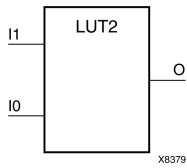

Introduction

This design element is a 2-bit look-up table (LUT) with general output (O).

An INIT attribute with an appropriate number of hexadecimal digits for the number of inputs must be attached to the LUT to specify its function. This element provides a look-up table version of a buffer or inverter. These elements are the basic building blocks. Two LUTs are available in each CLB slice; four LUTs are available in each CLB. Multiple variants of LUTs accommodate additional types of outputs that can be used by different timing models for more accurate pre-layout timing estimation.

The INIT parameter for the FPGA LUT primitive is what gives the LUT its logical value. By default, this value is zero, thus driving the output to a zero regardless of the input values (acting as a ground). However, in most cases a new INIT value must be determined in order to specify the logic function for the LUT primitive. There are at least two methods by which the LUT value can be determined:

The Logic Table Method -A common method to determine the desired INIT value for a LUT is using a logic table. To do so, simply create a binary logic table of all possible inputs, specify the desired logic value of the output and then create the INIT string from those output values.

The Equation Method -Another method to determine the LUT value is to define parameters for each input to the LUT that correspond to their listed truth value and use those to build the logic equation you are after. This method is easier to understand once you have grasped the concept and is more self-documenting than the above method. However, this method does require the code to first specify the appropriate parameters.

Logic Table

Inputs		Outputs
I1	I0	O
0	0	INIT[0]
0	1	INIT[1]
1	0	INIT[2]
1	1	INIT[3]

INIT = Binary equivalent of the hexadecimal number assigned to the INIT attribute

Design Entry Method

This design element can be used in schematics.

Available Attributes

Attribute	Data Type	Allowed Values	Default	Description
INIT	Hexadecimal	Any 4-Bit Value	All zeros	Initializes look-up tables.

For More Information

- See the [Spartan-3 Generation FPGA User Guide \(UG331\)](#).
- See the [Spartan-3E FPGA Family Data Sheet \(DS312\)](#).

LUT2_D

Primitive: 2-Bit Look-Up Table with Dual Output

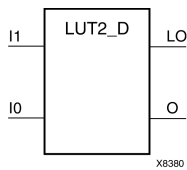

Introduction

This design element is a 2-bit look-up table (LUT) with two functionally identical outputs, O and LO.

The O output is a general interconnect. The LO output is used to connect to another input within the same CLB slice and to the fast connect buffer. A mandatory INIT attribute, with an appropriate number of hexadecimal digits for the number of inputs, must be attached to the LUT to specify its function.

The INIT parameter for the FPGA LUT primitive is what gives the LUT its logical value. By default, this value is zero, thus driving the output to a zero regardless of the input values (acting as a ground). However, in most cases a new INIT value must be determined in order to specify the logic function for the LUT primitive. There are at least two methods by which the LUT value can be determined:

- **The Logic Table Method** -A common method to determine the desired INIT value for a LUT is using a logic table. To do so, simply create a binary logic table of all possible inputs, specify the desired logic value of the output and then create the INIT string from those output values.
- **The Equation Method** -Another method to determine the LUT value is to define parameters for each input to the LUT that correspond to their listed truth value and use those to build the logic equation. This method is easier to understand once you have grasped the concept and is more self-documenting than the above method. However, this method does require the code to first specify the appropriate parameters.

Logic Table

Inputs		Outputs	
I1	I0	O	LO
0	0	INIT[0]	INIT[0]
0	1	INIT[1]	INIT[1]
1	0	INIT[2]	INIT[2]
1	1	INIT[3]	INIT[3]

INIT = Binary equivalent of the hexadecimal number assigned to the INIT attribute

Design Entry Method

This design element can be used in schematics.

Available Attributes

Attribute	Data Type	Allowed Values	Default	Description
INIT	Hexadecimal	Any 4-Bit Value	All zeros	Initializes look-up tables.

For More Information

- See the [Spartan-3 Generation FPGA User Guide \(UG331\)](#).
- See the [Spartan-3E FPGA Family Data Sheet \(DS312\)](#).

LUT2_L

Primitive: 2-Bit Look-Up Table with Local Output

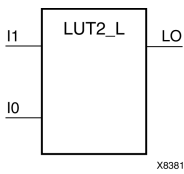

Introduction

This design element is a 2-bit look-up table (LUT) with a local output (LO) that is used to connect to another output within the same CLB slice and to the fast connect buffer. It provides a look-up table version of a buffer or inverter.

A mandatory INIT attribute, with an appropriate number of hexadecimal digits for the number of inputs, must be attached to the LUT to specify its function.

The INIT parameter for the FPGA LUT primitive is what gives the LUT its logical value. By default, this value is zero, thus driving the output to a zero regardless of the input values (acting as a ground). However, in most cases a new INIT value must be determined in order to specify the logic function for the LUT primitive. There are at least two methods by which the LUT value can be determined:

The Logic Table Method -A common method to determine the desired INIT value for a LUT is using a logic table. To do so, simply create a binary logic table of all possible inputs, specify the desired logic value of the output and then create the INIT string from those output values.

The Equation Method -Another method to determine the LUT value is to define parameters for each input to the LUT that correspond to their listed truth value and use those to build the logic equation you are after. This method is easier to understand once you have grasped the concept and is more self-documenting than the above method. However, this method does require the code to first specify the appropriate parameters.

Logic Table

Inputs		Outputs
I1	I0	LO
0	0	INIT[0]
0	1	INIT[1]
1	0	INIT[2]
1	1	INIT[3]

INIT = Binary equivalent of the hexadecimal number assigned to the INIT attribute

Design Entry Method

This design element can be used in schematics.

Available Attributes

Attribute	Data Type	Allowed Values	Default	Description
INIT	Hexadecimal	Any 4-Bit Value	All zeros	Initializes look-up tables.

For More Information

- See the [Spartan-3 Generation FPGA User Guide \(UG331\)](#).
- See the [Spartan-3E FPGA Family Data Sheet \(DS312\)](#).

LUT3

Primitive: 3-Bit Look-Up Table with General Output

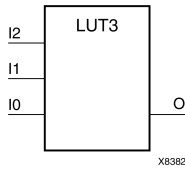

Introduction

This design element is a 3-bit look-up table (LUT) with general output (O). A mandatory INIT attribute, with an appropriate number of hexadecimal digits for the number of inputs, must be attached to the LUT to specify its function.

An INIT attribute with an appropriate number of hexadecimal digits for the number of inputs must be attached to the LUT to specify its function. This element provides a look-up table version of a buffer or inverter. These elements are the basic building blocks. Two LUTs are available in each CLB slice; four LUTs are available in each CLB. Multiple variants of LUTs accommodate additional types of outputs that can be used by different timing models for more accurate pre-layout timing estimation.

The INIT parameter for the FPGA LUT primitive is what gives the LUT its logical value. By default, this value is zero, thus driving the output to a zero regardless of the input values (acting as a ground). However, in most cases a new INIT value must be determined in order to specify the logic function for the LUT primitive. There are at least two methods by which the LUT value can be determined:

The Logic Table Method -A common method to determine the desired INIT value for a LUT is using a logic table. To do so, simply create a binary logic table of all possible inputs, specify the desired logic value of the output and then create the INIT string from those output values.

The Equation Method -Another method to determine the LUT value is to define parameters for each input to the LUT that correspond to their listed truth value and use those to build the logic equation you are after. This method is easier to understand once you have grasped the concept and is more self-documenting than the above method. However, this method does require the code to first specify the appropriate parameters.

Logic Table

Inputs			Outputs
I2	I1	I0	O
0	0	0	INIT[0]
0	0	1	INIT[1]
0	1	0	INIT[2]
0	1	1	INIT[3]
1	0	0	INIT[4]
1	0	1	INIT[5]
1	1	0	INIT[6]
1	1	1	INIT[7]

INIT = Binary equivalent of the hexadecimal number assigned to the INIT attribute

Design Entry Method

This design element can be used in schematics.

Available Attributes

Attribute	Data Type	Allowed Values	Default	Description
INIT	Hexadecimal	Any 8-Bit Value	All zeros	Initializes look-up tables.

For More Information

- See the [Spartan-3 Generation FPGA User Guide \(UG331\)](#).
- See the [Spartan-3E FPGA Family Data Sheet \(DS312\)](#).

LUT3_D

Primitive: 3-Bit Look-Up Table with Dual Output

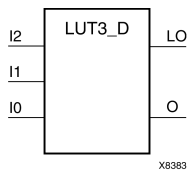

Introduction

This design element is a 3-bit look-up table (LUT) with two functionally identical outputs, O and LO.

The O output is a general interconnect. The LO output is used to connect to another input within the same CLB slice and to the fast connect buffer. A mandatory INIT attribute, with an appropriate number of hexadecimal digits for the number of inputs, must be attached to the LUT to specify its function.

The INIT parameter for the FPGA LUT primitive is what gives the LUT its logical value. By default, this value is zero, thus driving the output to a zero regardless of the input values (acting as a ground). However, in most cases a new INIT value must be determined in order to specify the logic function for the LUT primitive. There are at least two methods by which the LUT value can be determined:

- **The Logic Table Method** -A common method to determine the desired INIT value for a LUT is using a logic table. To do so, simply create a binary logic table of all possible inputs, specify the desired logic value of the output and then create the INIT string from those output values.
- **The Equation Method** -Another method to determine the LUT value is to define parameters for each input to the LUT that correspond to their listed truth value and use those to build the logic equation. This method is easier to understand once you have grasped the concept and is more self-documenting than the above method. However, this method does require the code to first specify the appropriate parameters.

Logic Table

Inputs			Outputs	
I2	I1	I0	O	LO
0	0	0	INIT[0]	INIT[0]
0	0	1	INIT[1]	INIT[1]
0	1	0	INIT[2]	INIT[2]
0	1	1	INIT[3]	INIT[3]
1	0	0	INIT[4]	INIT[4]
1	0	1	INIT[5]	INIT[5]
1	1	0	INIT[6]	INIT[6]
1	1	1	INIT[7]	INIT[7]

INIT = Binary equivalent of the hexadecimal number assigned to the INIT attribute

Design Entry Method

This design element can be used in schematics.

Available Attributes

Attribute	Data Type	Allowed Values	Default	Description
INIT	Hexadecimal	Any 8-Bit Value	All zeros	Initializes look-up tables.

For More Information

- See the [Spartan-3 Generation FPGA User Guide \(UG331\)](#).
- See the [Spartan-3E FPGA Family Data Sheet \(DS312\)](#).

LUT3_L

Primitive: 3-Bit Look-Up Table with Local Output

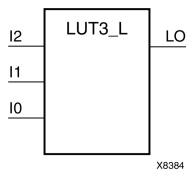

Introduction

This design element is a 3-bit look-up table (LUT) with a local output (LO) that is used to connect to another output within the same CLB slice and to the fast connect buffer. It provides a look-up table version of a buffer or inverter.

A mandatory INIT attribute, with an appropriate number of hexadecimal digits for the number of inputs, must be attached to the LUT to specify its function.

The INIT parameter for the FPGA LUT primitive is what gives the LUT its logical value. By default, this value is zero, thus driving the output to a zero regardless of the input values (acting as a ground). However, in most cases a new INIT value must be determined in order to specify the logic function for the LUT primitive. There are at least two methods by which the LUT value can be determined:

The Logic Table Method -A common method to determine the desired INIT value for a LUT is using a logic table. To do so, simply create a binary logic table of all possible inputs, specify the desired logic value of the output and then create the INIT string from those output values.

The Equation Method -Another method to determine the LUT value is to define parameters for each input to the LUT that correspond to their listed truth value and use those to build the logic equation you are after. This method is easier to understand once you have grasped the concept and is more self-documenting than the above method. However, this method does require the code to first specify the appropriate parameters.

Logic Table

Inputs			Outputs
I2	I1	I0	LO
0	0	0	INIT[0]
0	0	1	INIT[1]
0	1	0	INIT[2]
0	1	1	INIT[3]
1	0	0	INIT[4]
1	0	1	INIT[5]
1	1	0	INIT[6]
1	1	1	INIT[7]

INIT = Binary equivalent of the hexadecimal number assigned to the INIT attribute

Design Entry Method

This design element can be used in schematics.

Available Attributes

Attribute	Data Type	Allowed Values	Default	Description
INIT	Hexadecimal	Any 8-Bit Value	All zeros	Initializes look-up tables.

For More Information

- See the [Spartan-3 Generation FPGA User Guide \(UG331\)](#).
- See the [Spartan-3E FPGA Family Data Sheet \(DS312\)](#).

LUT4

Primitive: 4-Bit Look-Up-Table with General Output

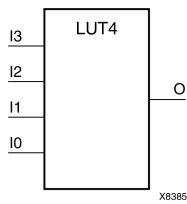

Introduction

This design element is a 4-bit look-up table (LUT) with general output (O).

An INIT attribute with an appropriate number of hexadecimal digits for the number of inputs must be attached to the LUT to specify its function. This element provides a look-up table version of a buffer or inverter. These elements are the basic building blocks. Two LUTs are available in each CLB slice; four LUTs are available in each CLB. Multiple variants of LUTs accommodate additional types of outputs that can be used by different timing models for more accurate pre-layout timing estimation.

The INIT parameter for the FPGA LUT primitive is what gives the LUT its logical value. By default, this value is zero, thus driving the output to a zero regardless of the input values (acting as a ground). However, in most cases a new INIT value must be determined in order to specify the logic function for the LUT primitive. There are at least two methods by which the LUT value can be determined:

The Logic Table Method -A common method to determine the desired INIT value for a LUT is using a logic table. To do so, simply create a binary logic table of all possible inputs, specify the desired logic value of the output and then create the INIT string from those output values.

The Equation Method -Another method to determine the LUT value is to define parameters for each input to the LUT that correspond to their listed truth value and use those to build the logic equation you are after. This method is easier to understand once you have grasped the concept and is more self-documenting than the above method. However, this method does require the code to first specify the appropriate parameters.

Logic Table

Inputs				Outputs
I3	I2	I1	I0	O
0	0	0	0	INIT[0]
0	0	0	1	INIT[1]
0	0	1	0	INIT[2]
0	0	1	1	INIT[3]
0	1	0	0	INIT[4]
0	1	0	1	INIT[5]
0	1	1	0	INIT[6]
0	1	1	1	INIT[7]
1	0	0	0	INIT[8]
1	0	0	1	INIT[9]
1	0	1	0	INIT[10]
1	0	1	1	INIT[11]

Inputs				Outputs
I3	I2	I1	I0	O
1	1	0	0	INIT[12]
1	1	0	1	INIT[13]
1	1	1	0	INIT[14]
1	1	1	1	INIT[15]

INIT = Binary equivalent of the hexadecimal number assigned to the INIT attribute

Design Entry Method

This design element can be used in schematics.

Available Attributes

Attribute	Data Type	Allowed Values	Default	Description
INIT	Hexadecimal	Any 16-Bit Value	All zeros	Initializes look-up tables.

For More Information

- See the [Spartan-3 Generation FPGA User Guide \(UG331\)](#).
- See the [Spartan-3E FPGA Family Data Sheet \(DS312\)](#).

LUT4_D

Primitive: 4-Bit Look-Up Table with Dual Output

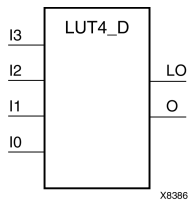

Introduction

This design element is a 4-bit look-up table (LUT) with two functionally identical outputs, O and LO

The O output is a general interconnect. The LO output is used to connect to another input within the same CLB slice and to the fast connect buffer. A mandatory INIT attribute, with an appropriate number of hexadecimal digits for the number of inputs, must be attached to the LUT to specify its function.

The INIT parameter for the FPGA LUT primitive is what gives the LUT its logical value. By default, this value is zero, thus driving the output to a zero regardless of the input values (acting as a ground). However, in most cases a new INIT value must be determined in order to specify the logic function for the LUT primitive. There are at least two methods by which the LUT value can be determined:

- **The Logic Table Method** -A common method to determine the desired INIT value for a LUT is using a logic table. To do so, simply create a binary logic table of all possible inputs, specify the desired logic value of the output and then create the INIT string from those output values.
- **The Equation Method** -Another method to determine the LUT value is to define parameters for each input to the LUT that correspond to their listed truth value and use those to build the logic equation. This method is easier to understand once you have grasped the concept and is more self-documenting than the above method. However, this method does require the code to first specify the appropriate parameters.

Logic Table

Inputs				Outputs	
I3	I2	I1	I0	O	LO
0	0	0	0	INIT[0]	INIT[0]
0	0	0	1	INIT[1]	INIT[1]
0	0	1	0	INIT[2]	INIT[2]
0	0	1	1	INIT[3]	INIT[3]
0	1	0	0	INIT[4]	INIT[4]
0	1	0	1	INIT[5]	INIT[5]
0	1	1	0	INIT[6]	INIT[6]
0	1	1	1	INIT[7]	INIT[7]
1	0	0	0	INIT[8]	INIT[8]
1	0	0	1	INIT[9]	INIT[9]
1	0	1	0	INIT[10]	INIT[10]
1	0	1	1	INIT[11]	INIT[11]
1	1	0	0	INIT[12]	INIT[12]
1	1	0	1	INIT[13]	INIT[13]

Inputs				Outputs	
I3	I2	I1	I0	O	LO
1	1	1	0	INIT[14]	INIT[14]
1	1	1	1	INIT[15]	INIT[15]

INIT = Binary equivalent of the hexadecimal number assigned to the INIT attribute

Design Entry Method

This design element can be used in schematics.

Available Attributes

Attribute	Data Type	Allowed Values	Default	Description
INIT	Hexadecimal	Any 16-Bit Value	All zeros	Initializes look-up tables.

For More Information

- See the [Spartan-3 Generation FPGA User Guide \(UG331\)](#).
- See the [Spartan-3E FPGA Family Data Sheet \(DS312\)](#).

LUT4_L

Primitive: 4-Bit Look-Up Table with Local Output

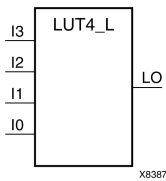

Introduction

This design element is a 4-bit look-up table (LUT) with a local output (LO) that is used to connect to another output within the same CLB slice and to the fast connect buffer. It provides a look-up table version of a buffer or inverter.

A mandatory INIT attribute, with an appropriate number of hexadecimal digits for the number of inputs, must be attached to the LUT to specify its function.

The INIT parameter for the FPGA LUT primitive is what gives the LUT its logical value. By default, this value is zero, thus driving the output to a zero regardless of the input values (acting as a ground). However, in most cases a new INIT value must be determined in order to specify the logic function for the LUT primitive. There are at least two methods by which the LUT value can be determined:

The Logic Table Method -A common method to determine the desired INIT value for a LUT is using a logic table. To do so, simply create a binary logic table of all possible inputs, specify the desired logic value of the output and then create the INIT string from those output values.

The Equation Method -Another method to determine the LUT value is to define parameters for each input to the LUT that correspond to their listed truth value and use those to build the logic equation you are after. This method is easier to understand once you have grasped the concept and more self-documenting than the above method. However, this method does require the code to first specify the appropriate parameters.

Logic Table

Inputs				Outputs
I3	I2	I1	I0	LO
0	0	0	0	INIT[0]
0	0	0	1	INIT[1]
0	0	1	0	INIT[2]
0	0	1	1	INIT[3]
0	1	0	0	INIT[4]
0	1	0	1	INIT[5]
0	1	1	0	INIT[6]
0	1	1	1	INIT[7]
1	0	0	0	INIT[8]
1	0	0	1	INIT[9]
1	0	1	0	INIT[10]
1	0	1	1	INIT[11]
1	1	0	0	INIT[12]

Inputs				Outputs
I3	I2	I1	I0	LO
1	1	0	1	INIT[13]
1	1	1	0	INIT[14]
1	1	1	1	INIT[15]

INIT = Binary equivalent of the hexadecimal number assigned to the INIT attribute

Design Entry Method

This design element can be used in schematics.

Available Attributes

Attribute	Data Type	Allowed Values	Default	Description
INIT	Hexadecimal	Any 16-Bit Value	All zeros	Initializes look-up tables.

For More Information

- See the [Spartan-3 Generation FPGA User Guide \(UG331\)](#).
- See the [Spartan-3E FPGA Family Data Sheet \(DS312\)](#).

M16_1E

Macro: 16-to-1 Multiplexer with Enable

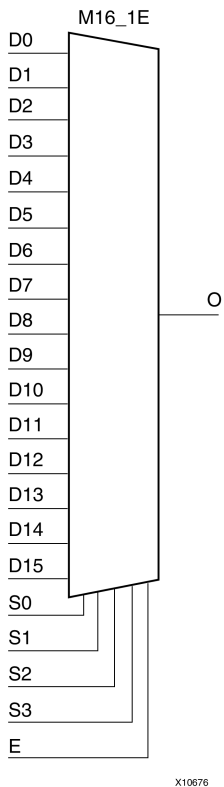

X10676

Introduction

This design element is a 16-to-1 multiplexer with enable. When the enable input (E) is High, the M16_1E multiplexer chooses one data bit from 16 sources (D15 : D0) under the control of the select inputs (S3 : S0). The output (O) reflects the state of the selected input as shown in the logic table. When (E) is Low, the output is Low.

Logic Table

Inputs						Outputs
E	S3	S2	S1	S0	D15-D0	O
0	X	X	X	X	X	0
1	0	0	0	0	D0	D0
1	0	0	0	1	D1	D1
1	0	0	1	0	D2	D2
1	0	0	1	1	D3	D3
.
.
.
1	1	1	0	0	D12	D12
1	1	1	0	1	D13	D13

Inputs						Outputs
E	S3	S2	S1	S0	D15-D0	O
1	1	1	1	0	D14	D14
1	1	1	1	1	D15	D15

Design Entry Method

This design element is only for use in schematics.

For More Information

- See the [Spartan-3 Generation FPGA User Guide \(UG331\)](#).
- See the [Spartan-3E FPGA Family Data Sheet \(DS312\)](#).

M2_1

Macro: 2-to-1 Multiplexer

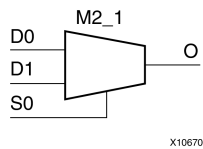

Introduction

This design element chooses one data bit from two sources (D1 or D0) under the control of the select input (S0). The output (O) reflects the state of the selected data input. When Low, S0 selects D0 and when High, S0 selects D1.

Logic Table

Inputs			Outputs
S0	D1	D0	O
1	D1	X	D1
0	X	D0	D0

Design Entry Method

This design element is only for use in schematics.

For More Information

- See the [Spartan-3 Generation FPGA User Guide \(UG331\)](#).
- See the [Spartan-3E FPGA Family Data Sheet \(DS312\)](#).

M2_1B1

Macro: 2-to-1 Multiplexer with D0 Inverted

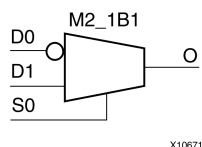

Introduction

This design element chooses one data bit from two sources (D1 or D0) under the control of select input (S0). When S0 is Low, the output (O) reflects the inverted value of (D0). When S0 is High, (O) reflects the state of D1.

Logic Table

Inputs			Outputs
S0	D1	D0	O
1	1	X	1
1	0	X	0
0	X	1	0
0	X	0	1

Design Entry Method

This design element is only for use in schematics.

For More Information

- See the [Spartan-3 Generation FPGA User Guide \(UG331\)](#).
- See the [Spartan-3E FPGA Family Data Sheet \(DS312\)](#).

M2_1B2

Macro: 2-to-1 Multiplexer with D0 and D1 Inverted

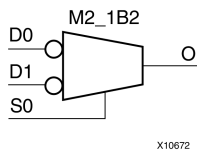

Introduction

This design element chooses one data bit from two sources (D1 or D0) under the control of select input (S0). When S0 is Low, the output (O) reflects the inverted value of D0. When S0 is High, O reflects the inverted value of D1.

Logic Table

Inputs			Outputs
S0	D1	D0	O
1	1	X	0
1	0	X	1
0	X	1	0
0	X	0	1

Design Entry Method

This design element is only for use in schematics.

For More Information

- See the [Spartan-3 Generation FPGA User Guide \(UG331\)](#).
- See the [Spartan-3E FPGA Family Data Sheet \(DS312\)](#).

M2_1E

Macro: 2-to-1 Multiplexer with Enable

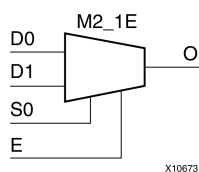

Introduction

This design element is a 2-to-1 multiplexer with enable. When the enable input (E) is High, the M2_1E chooses one data bit from two sources (D1 or D0) under the control of select input (S0). When Low, S0 selects D0 and when High, S0 selects D1. When (E) is Low, the output is Low.

Logic Table

Inputs				Outputs
E	S0	D1	D0	O
0	X	X	X	0
1	0	X	1	1
1	0	X	0	0
1	1	1	X	1
1	1	0	X	0

Design Entry Method

This design element is only for use in schematics.

For More Information

- See the [Spartan-3 Generation FPGA User Guide \(UG331\)](#).
- See the [Spartan-3E FPGA Family Data Sheet \(DS312\)](#).

M4_1E

Macro: 4-to-1 Multiplexer with Enable

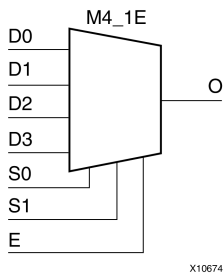

Introduction

This design element is a 4-to-1 multiplexer with enable. When the enable input (E) is High, the M4_1E multiplexer chooses one data bit from four sources (D3, D2, D1, or D0) under the control of the select inputs (S1 : S0). The output (O) reflects the state of the selected input as shown in the logic table. When (E) is Low, the output is Low.

Logic Table

Inputs							Outputs
E	S1	S0	D0	D1	D2	D3	O
0	X	X	X	X	X	X	0
1	0	0	D0	X	X	X	D0
1	0	1	X	D1	X	X	D1
1	1	0	X	X	D2	X	D2
1	1	1	X	X	X	D3	D3

Design Entry Method

This design element is only for use in schematics.

For More Information

- See the [Spartan-3 Generation FPGA User Guide \(UG331\)](#).
- See the [Spartan-3E FPGA Family Data Sheet \(DS312\)](#).

M8_1E

Macro: 8-to-1 Multiplexer with Enable

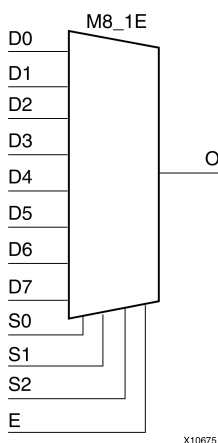

Introduction

This design element is an 8-to-1 multiplexer with enable. When the enable input (E) is High, the M8_1E multiplexer chooses one data bit from eight sources (D7 : D0) under the control of the select inputs (S2 : S0). The output (O) reflects the state of the selected input as shown in the logic table. When (E) is Low, the output is Low.

Logic Table

Inputs					Outputs
E	S2	S1	S0	D7-D0	O
0	X	X	X	X	0
1	0	0	0	D0	D0
1	0	0	1	D1	D1
1	0	1	0	D2	D2
1	0	1	1	D3	D3
1	1	0	0	D4	D4
1	1	0	1	D5	D5
1	1	1	0	D6	D6
1	1	1	1	D7	D7

Design Entry Method

This design element is only for use in schematics.

For More Information

- See the [Spartan-3 Generation FPGA User Guide \(UG331\)](#).
- See the [Spartan-3E FPGA Family Data Sheet \(DS312\)](#).

MULT_AND

Primitive: Fast Multiplier AND

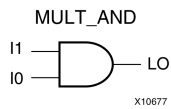

Introduction

The design element is an AND component located within the slice where the two inputs are shared with the 4-input LUT and the output drives into the carry logic. This added logic is especially useful for building fast and smaller multipliers. However, it can be used for other purposes as well. The I1 and I0 inputs must be connected to the I1 and I0 inputs of the associated LUT. The LO output must be connected to the DI input of the associated MUXCY, MUXCY_D, or MUXCY_L.

Logic Table

Inputs		Outputs
I1	I0	LO
0	0	0
0	1	0
1	0	0
1	1	1

Design Entry Method

This design element can be used in schematics.

For More Information

- See the [Spartan-3 Generation FPGA User Guide \(UG331\)](#).
- See the [Spartan-3E FPGA Family Data Sheet \(DS312\)](#).

MULT18X18

Primitive: 18 x 18 Signed Multiplier

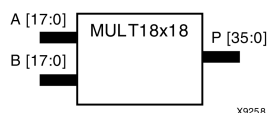

Introduction

MULT18X18 is a combinational signed 18-bit by 18-bit multiplier. The value represented in the 18-bit input A is multiplied by the value represented in the 18-bit input B. Output P is the 36-bit product of A and B.

Logic Table

Inputs		Output
A	B	P
A	B	A x B
A, B, and P are two's complement.		

Design Entry Method

This design element can be used in schematics.

For More Information

- See the [Spartan-3 Generation FPGA User Guide \(UG331\)](#).
- See the [Spartan-3E FPGA Family Data Sheet \(DS312\)](#).

MULT18X18S

Primitive: 18 x 18 Signed Multiplier Registered Version

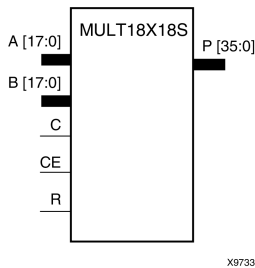

Introduction

MULT18X18S is the registered version of the 18 x 18 signed multiplier with output P and inputs A, B, C, CE, and R. The registers are initialized to 0 after the GSR pulse.

The value represented in the 18-bit input A is multiplied by the value represented in the 18-bit input B. Output P is the 36-bit product of A and B.

Logic Table

Inputs					Output
C	CE	Am	Bn	R	P
↑	X	X	X	1	0
↑	1	Am	Bn	0	A x B
X	0	X	X	0	No Change

A, B, and P are two's complement.

Design Entry Method

This design element can be used in schematics.

For More Information

- See the [Spartan-3 Generation FPGA User Guide \(UG331\)](#).
- See the [Spartan-3E FPGA Family Data Sheet \(DS312\)](#).

MULT18X18SIO

Primitive: 18 x 18 Cascadable Signed Multiplier with Optional Input and Output Registers, Clock Enable, and Synchronous Reset

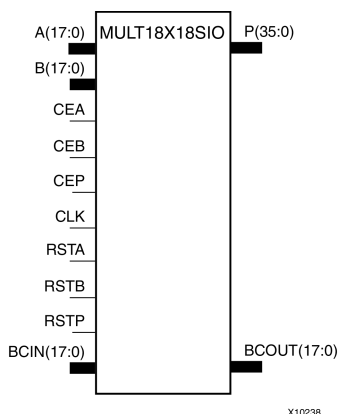

Introduction

This design element is a 36-bit output, 18x18-bit input dedicated signed multiplier. This component can perform asynchronous multiplication operations when the attributes AREG, BREG and PREG are all set to 0. Alternatively, synchronous multiplication operations of different latency and performance characteristics can be performed when any combination of those attributes is set to 1. When using the multiplier in synchronous operation, the MULT18X18SIO features active high clock enables for each set of register banks in the multiplier, CEA, CEB and CEP, as well as synchronous resets, RSTA, RSTB, and RSTP. Multiple MULT18X18SIOs can be cascaded to create larger multiplication functions using the BCIN and BCOUT ports in combination with the B_INPUT attribute.

Design Entry Method

This design element can be used in schematics.

Available Attributes

Attribute	Data Type	Allowed Values	Default	Descriptions
AREG	Integer	0, 1	1	Specifies the use of the input registers on the A port. A zero disables the use of the register; a one enables the register.
BREG	Integer	0, 1	1	Specifies the use of the input registers on the B port. A zero disables the use of the register; a one enables the register.
B_INPUT	String	"DIRECT" or "CASCADE"	"DIRECT"	Specifies whether the B port is connected to the general FPGA fabric, "DIRECT" or is connected to the BCOUT port of another MULT18X18SIO.
PREG	Integer	0, 1	1	Specifies the use of the output registers of the multiplier. A zero disables the use of the register; a one enables the register.

For More Information

- See the [Spartan-3 Generation FPGA User Guide \(UG331\)](#).
- See the [Spartan-3E FPGA Family Data Sheet \(DS312\)](#).

MUXCY

Primitive: 2-to-1 Multiplexer for Carry Logic with General Output

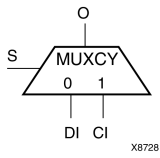

Introduction

The direct input (DI) of a slice is connected to the (DI) input of the MUXCY. The carry in (CI) input of an LC is connected to the CI input of the MUXCY. The select input (S) of the MUXCY is driven by the output of the look-up table (LUT) and configured as a MUX function. The carry out (O) of the MUXCY reflects the state of the selected input and implements the carry out function of each LC. When Low, S selects DI; when High, S selects CI.

The variants MUXCY_D and MUXCY_L provide additional types of outputs that can be used by different timing models for more accurate pre-layout timing estimation.

Logic Table

Inputs			Outputs
S	DI	CI	O
0	1	X	1
0	0	X	0
1	X	1	1
1	X	0	0

Design Entry Method

This design element can be used in schematics.

For More Information

- See the [Spartan-3 Generation FPGA User Guide \(UG331\)](#).
- See the [Spartan-3E FPGA Family Data Sheet \(DS312\)](#).

MUXCY_D

Primitive: 2-to-1 Multiplexer for Carry Logic with Dual Output

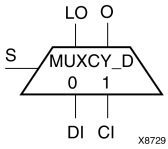

Introduction

This design element implements a 1-bit, high-speed carry propagate function. One such function can be implemented per logic cell (LC), for a total of 4-bits per configurable logic block (CLB). The direct input (DI) of an LC is connected to the DI input of the MUXCY_D. The carry in (CI) input of an LC is connected to the CI input of the MUXCY_D. The select input (S) of the MUX is driven by the output of the look-up table (LUT) and configured as an XOR function. The carry out (O and LO) of the MUXCY_D reflects the state of the selected input and implements the carry out function of each LC. When Low, S selects DI; when High, S selects CI.

Outputs O and LO are functionally identical. The O output is a general interconnect. See also MUXCY and MUXCY_L.

Logic Table

Inputs			Outputs	
S	DI	CI	O	LO
0	1	X	1	1
0	0	X	0	0
1	X	1	1	1
1	X	0	0	0

Design Entry Method

This design element can be used in schematics.

For More Information

- See the [Spartan-3 Generation FPGA User Guide \(UG331\)](#).
- See the [Spartan-3E FPGA Family Data Sheet \(DS312\)](#).

MUXCY_L

Primitive: 2-to-1 Multiplexer for Carry Logic with Local Output

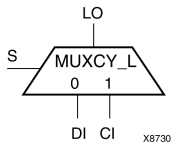

Introduction

This design element implements a 1-bit high-speed carry propagate function. One such function is implemented per logic cell (LC), for a total of 4-bits per configurable logic block (CLB). The direct input (DI) of an LC is connected to the DI input of the MUXCY_L. The carry in (CI) input of an LC is connected to the CI input of the MUXCY_L. The select input (S) of the MUXCY_L is driven by the output of the look-up table (LUT) and configured as an XOR function. The carry out (LO) of the MUXCY_L reflects the state of the selected input and implements the carry out function of each (LC). When Low, (S) selects DI; when High, (S) selects (CI).

See also MUXCY and MUXCY_D.

Logic Table

Inputs			Outputs
S	DI	CI	LO
0	1	X	1
0	0	X	0
1	X	1	1
1	X	0	0

Design Entry Method

This design element can be used in schematics.

For More Information

- See the [Spartan-3 Generation FPGA User Guide \(UG331\)](#).
- See the [Spartan-3E FPGA Family Data Sheet \(DS312\)](#).

MUXF5

Primitive: 2-to-1 Look-Up Table Multiplexer with General Output

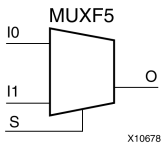

Introduction

This design element is a two input multiplexer for creating a function-of-5 look-up table or a 4-to-1 multiplexer when connected to LUT4 look-up tables. The local outputs (LO) from two LUT4 look-up tables are connected to the I0 and I1 inputs of the MUXF5. The S input is driven from any internal net. When Low, S selects I0. When High, S selects I1.

The O output is a general interconnect.

The variants MUXF5_D and MUXF5_L provide additional types of outputs that can be used by different timing models for more accurate pre-layout timing estimation.

Logic Table

Inputs			Outputs
S	I0	I1	O
0	1	X	1
0	0	X	0
1	X	1	1
1	X	0	0

Design Entry Method

This design element can be used in schematics.

For More Information

- See the [Spartan-3 Generation FPGA User Guide \(UG331\)](#).
- See the [Spartan-3E FPGA Family Data Sheet \(DS312\)](#).

MUXF5_D

Primitive: 2-to-1 Look-Up Table Multiplexer with Dual Output

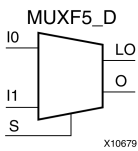

Introduction

This design element is a two input multiplexer for creating a function-of-5 look-up table or a 4-to-1 multiplexer when connected to LUT4 look-up tables. The local outputs (LO) from two LUT4 look-up tables are connected to the I0 and I1 inputs of the MUXF5. The S input is driven from any internal net. When Low, S selects I0. When High, S selects I1.

Outputs O and LO are functionally identical. The O output is a general interconnect. The LO output connects to other inputs in the same CLB slice.

See also MUXF5 and MUXF5_L.

Logic Table

Inputs			Outputs	
S	I0	I1	O	LO
0	1	X	1	1
0	0	X	0	0
1	X	1	1	1
1	X	0	0	0

Design Entry Method

This design element can be used in schematics.

For More Information

- See the [Spartan-3 Generation FPGA User Guide \(UG331\)](#).
- See the [Spartan-3E FPGA Family Data Sheet \(DS312\)](#).

MUXF5_L

Primitive: 2-to-1 Look-Up Table Multiplexer with Local Output

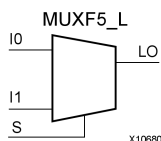

Introduction

This design element is a two input multiplexer for creating a function-of-5 look-up table or a 4-to-1 multiplexer when connected to LUT4 look-up tables. The local outputs (LO) from two LUT4 look-up tables are connected to the I0 and I1 inputs of the MUXF5. The S input is driven from any internal net. When Low, S selects I0. When High, S selects I1.

The LO output connects to other inputs in the same CLB slice.

See also MUXF5 and MUXF5_D.

Logic Table

Inputs			Output
S	I0	I1	LO
0	1	X	1
0	0	X	0
1	X	1	1
1	X	0	0

Design Entry Method

This design element can be used in schematics.

For More Information

- See the [Spartan-3 Generation FPGA User Guide \(UG331\)](#).
- See the [Spartan-3E FPGA Family Data Sheet \(DS312\)](#).

MUXF6

Primitive: 2-to-1 Look-Up Table Multiplexer with General Output

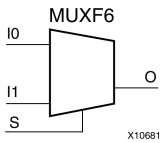

Introduction

This design element is a two input multiplexer in two slices for creating a function-of-6 look-up table or an 8-to-1 multiplexer in combination with the associated four LUT4 look-up tables and two MUXF5 multiplexers. The local outputs (LO) from two MUXF5 multiplexers in the CLB are connected to the I0 and I1 inputs of the MUXF6. The S input is driven from any internal net. When Low, S selects I0. When High, S selects I1.

The O output is a general interconnect.

The variants MUXF6_D and MUXF6_L provide additional types of outputs that can be used by different timing models for more accurate pre-layout timing estimation.

Logic Table

Inputs			Outputs
S	I0	I1	O
0	1	X	1
0	0	X	0
1	X	1	1
1	X	0	0

Design Entry Method

This design element can be used in schematics.

For More Information

- See the [Spartan-3 Generation FPGA User Guide \(UG331\)](#).
- See the [Spartan-3E FPGA Family Data Sheet \(DS312\)](#).

MUXF6_D

Primitive: 2-to-1 Look-Up Table Multiplexer with Dual Output

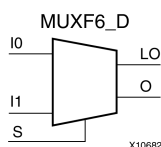

Introduction

This design element is a two input multiplexer in two slices for creating a function-of-6 look-up table or an 8-to-1 multiplexer in combination with the associated four LUT4 look-up tables and two MUXF5 multiplexers. The local outputs (LO) from two MUXF5 multiplexers in the CLB are connected to the I0 and I1 inputs of the MUXF6. The S input is driven from any internal net. When Low, S selects I0. When High, S selects I1.

Outputs O and LO are functionally identical. The O output is a general interconnect. The LO output connects to other inputs in the same CLB slice.

See also MUXF6 and MUXF6_L.

Logic Table

Inputs			Outputs	
S	I0	I1	O	LO
0	1	X	1	1
0	0	X	0	0
1	X	1	1	1
1	X	0	0	0

Design Entry Method

This design element can be used in schematics.

For More Information

- See the [Spartan-3 Generation FPGA User Guide \(UG331\)](#).
- See the [Spartan-3E FPGA Family Data Sheet \(DS312\)](#).

MUXF6_L

Primitive: 2-to-1 Look-Up Table Multiplexer with Local Output

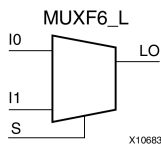

Introduction

This design element is a two input multiplexer in two slices for creating a function-of-6 look-up table or an 8-to-1 multiplexer in combination with the associated four LUT4 look-up tables and two MUXF5 multiplexers. The local outputs (LO) from two MUXF5 multiplexers in the CLB are connected to the I0 and I1 inputs of the MUXF6. The S input is driven from any internal net. When Low, S selects I0. When High, S selects I1.

The LO output connects to other inputs in the same CLB slice.

See also MUXF6 and MUXF6_D.

Logic Table

Inputs			Output
S	I0	I1	LO
0	1	X	1
0	0	X	0
1	X	1	1
1	X	0	0

Design Entry Method

This design element can be used in schematics.

For More Information

- See the [Spartan-3 Generation FPGA User Guide \(UG331\)](#).
- See the [Spartan-3E FPGA Family Data Sheet \(DS312\)](#).

MUXF7

Primitive: 2-to-1 Look-Up Table Multiplexer with General Output

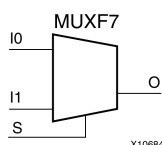

Introduction

This design element is a two input multiplexer for creating a function-of-7 look-up table or a 16-to-1 multiplexer in combination with the associated MUXF6 and MUXF5 multiplexers, and LUT4 look-up tables. Local outputs (LO) of two MUXF6 are connected to the I0 and I1 inputs of the MUXF7. The S input is driven from any internal net. When Low, S selects I0. When High, S selects I1.

The O output is a general interconnect.

The variants MUXF7_D and MUXF7_L provide additional types of outputs that can be used by different timing models for more accurate pre-layout timing estimation.

Logic Table

Inputs			Outputs
S	I0	I1	O
0	I0	X	I0
1	X	I1	I1
X	0	0	0
X	1	1	1

Port Descriptions

Port	Direction	Width	Function
O	Output	1	Output of MUX to general routing
I0	Input	1	Input (tie to MUXF6 LO out)
I1	Input	1	Input (tie to MUXF6 LO out)
S	Input	1	Input select to MUX

Design Entry Method

This design element can be used in schematics.

For More Information

- See the [Spartan-3 Generation FPGA User Guide \(UG331\)](#).
- See the [Spartan-3E FPGA Family Data Sheet \(DS312\)](#).

MUXF7_D

Primitive: 2-to-1 Look-Up Table Multiplexer with Dual Output

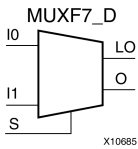

Introduction

This design element is a two input multiplexer for creating a function-of-7 look-up table or a 16-to-1 multiplexer in combination with the associated MUXF6 and MUXF5 multiplexers, and LUT4 look-up tables. Local outputs (LO) of two MUXF6 are connected to the I0 and I1 inputs of the MUXF7. The S input is driven from any internal net. When Low, S selects I0. When High, S selects I1.

Outputs O and LO are functionally identical. The O output is a general interconnect. The LO output connects to other inputs in the same CLB slice.

See also MUXF7 and MUXF7_L.

Logic Table

Inputs			Outputs	
S	I0	I1	O	LO
0	I0	X	I0	I0
1	X	I1	I1	I1
X	0	0	0	0
X	1	1	1	1

Port Descriptions

Port	Direction	Width	Function
O	Output	1	Output of MUX to general routing
LO	Output	1	Output of MUX to local routing
I0	Input	1	Input (tie to MUXF6 LO out)
I1	Input	1	Input (tie to MUXF6 LO out)
S	Input	1	Input select to MUX

Design Entry Method

This design element can be used in schematics.

For More Information

- See the [Spartan-3 Generation FPGA User Guide \(UG331\)](#).
- See the [Spartan-3E FPGA Family Data Sheet \(DS312\)](#).

MUXF7_L

Primitive: 2-to-1 look-up table Multiplexer with Local Output

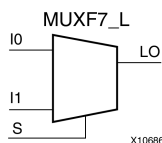

Introduction

This design element is a two input multiplexer for creating a function-of-7 look-up table or a 16-to-1 multiplexer in combination with the associated MUXF6 and MUXF5 multiplexers, and LUT4 look-up tables. Local outputs (LO) of two MUXF6 are connected to the I0 and I1 inputs of the MUXF7. The S input is driven from any internal net. When Low, S selects I0. When High, S selects I1.

The LO output connects to other inputs in the same CLB slice.

See also MUXF7 and MUXF7_D.

Logic Table

Inputs			Output
S	I0	I1	LO
0	I0	X	I0
1	X	I1	I1
X	0	0	0
X	1	1	1

Port Descriptions

Port	Direction	Width	Function
LO	Output	1	Output of MUX to local routing
I0	Input	1	Input
I1	Input	1	Input
S	Input	1	Input select to MUX

Design Entry Method

This design element can be used in schematics.

For More Information

- See the [Spartan-3 Generation FPGA User Guide \(UG331\)](#).
- See the [Spartan-3E FPGA Family Data Sheet \(DS312\)](#).

MUXF8

Primitive: 2-to-1 Look-Up Table Multiplexer with General Output

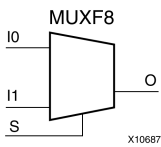

Introduction

This design element provides a multiplexer function in eight slices for creating a function-of-8 look-up table or a 32-to-1 multiplexer in combination with the associated look-up tables, MUXF5s, MUXF6s, and MUXF7s. Local outputs (LO) of MUXF7 are connected to the I0 and I1 inputs of the MUXF8. The S input is driven from any internal net. When Low, S selects I0. When High, S selects I1.

Logic Table

Inputs			Outputs
S	I0	I1	O
0	I0	X	I0
1	X	I1	I1
X	0	0	0
X	1	1	1

Port Descriptions

Port	Direction	Width	Function
O	Output	1	Output of MUX to general routing
I0	Input	1	Input (tie to MUXF7 LO out)
I1	Input	1	Input (tie to MUXF7 LO out)
S	Input	1	Input select to MUX

Design Entry Method

This design element can be used in schematics.

For More Information

- See the [Spartan-3 Generation FPGA User Guide \(UG331\)](#).
- See the [Spartan-3E FPGA Family Data Sheet \(DS312\)](#).

MUXF8_D

Primitive: 2-to-1 Look-Up Table Multiplexer with Dual Output

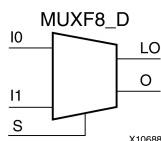

Introduction

This design element provides a multiplexer function in eight slices for creating a function-of-8 look-up table or a 32-to-1 multiplexer in combination with the associated look-up tables, MUXF5s, MUXF6s, and MUXF7s. Local outputs (LO) of MUXF7 are connected to the I0 and I1 inputs of the MUXF8. The S input is driven from any internal net. When Low, S selects I0. When High, S selects I1.

Outputs O and LO are functionally identical. The O output is a general interconnect. The LO output connects to other inputs in the same CLB slice.

Logic Table

Inputs			Outputs	
S	I0	I1	O	LO
0	I0	X	I0	I0
1	X	I1	I1	I1
X	0	0	0	0
X	1	1	1	1

Port Descriptions

Port	Direction	Width	Function
O	Output	1	Output of MUX to general routing
LO	Output	1	Output of MUX to local routing
I0	Input	1	Input (tie to MUXF7 LO out)
I1	Input	1	Input (tie to MUXF7 LO out)
S	Input	1	Input select to MUX

Design Entry Method

This design element can be used in schematics.

For More Information

- See the [Spartan-3 Generation FPGA User Guide \(UG331\)](#).
- See the [Spartan-3E FPGA Family Data Sheet \(DS312\)](#).

MUXF8_L

Primitive: 2-to-1 Look-Up Table Multiplexer with Local Output

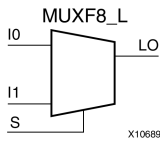

Introduction

This design element provides a multiplexer function in eight slices for creating a function-of-8 look-up table or a 32-to-1 multiplexer in combination with the associated look-up tables, MUXF5s, MUXF6s, and MUXF7s. Local outputs (LO) of MUXF7 are connected to the I0 and I1 inputs of the MUXF8. The S input is driven from any internal net. When Low, S selects I0. When High, S selects I1.

The LO output connects to other inputs in the same CLB slice.

Logic Table

Inputs			Output
S	I0	I1	LO
0	I0	X	I0
1	X	I1	I1
X	0	0	0
X	1	1	1

Port Descriptions

Port	Direction	Width	Function
LO	Output	1	Output of MUX to local routing
I0	Input	1	Input (tie to MUXF7 LO out)
I1	Input	1	Input (tie to MUXF7 LO out)
S	Input	1	Input select to MUX

Design Entry Method

This design element can be used in schematics.

For More Information

- See the [Spartan-3 Generation FPGA User Guide \(UG331\)](#).
- See the [Spartan-3E FPGA Family Data Sheet \(DS312\)](#).

NAND12

Macro: 12- Input NAND Gate with Non-Inverted Inputs

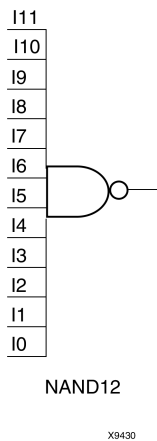

Introduction

NAND elements implement Negated AND or NOT AND. A High (1) output results when one or more inputs are a Low (0). A Low (0) output results only if all inputs are High (1).

NAND gates of up to five inputs are available in any combination of inverting and non-inverting inputs. NAND gates of six to nine inputs, 12 inputs, and 16 inputs are available with only non-inverting inputs. To invert inputs, use external inverters. Because each input uses a CLB resource, replace gates with unused inputs with gates having the necessary number of inputs.

Logic Table

Input	Output
I0 ... Iz	O
All inputs are 1	0
Any single input is 0	1

Design Entry Method

This design element is only for use in schematics.

For More Information

- See the [Spartan-3 Generation FPGA User Guide \(UG331\)](#).
- See the [Spartan-3E FPGA Family Data Sheet \(DS312\)](#).

NAND16

Macro: 16- Input NAND Gate with Non-Inverted Inputs

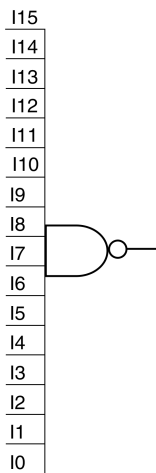

NAND16

X9431

Introduction

NAND elements implement Negated AND or NOT AND. A High (1) output results when one or more inputs are a Low (0). A Low (0) output results only if all inputs are High (1).

NAND gates of up to five inputs are available in any combination of inverting and non-inverting inputs. NAND gates of six to nine inputs, 12 inputs, and 16 inputs are available with only non-inverting inputs. To invert inputs, use external inverters. Because each input uses a CLB resource, replace gates with unused inputs with gates having the necessary number of inputs.

Logic Table

Input	Output
I0 ... Iz	O
All inputs are 1	0
Any single input is 0	1

Design Entry Method

This design element is only for use in schematics.

For More Information

- See the [Spartan-3 Generation FPGA User Guide \(UG331\)](#).
- See the [Spartan-3E FPGA Family Data Sheet \(DS312\)](#).

NAND2

Primitive: 2-Input NAND Gate with Non-Inverted Inputs

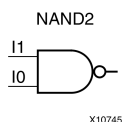

Introduction

NAND elements implement Negated AND or NOT AND. A High (1) output results when one or more inputs are a Low (0). A Low (0) output results only if all inputs are High (1).

NAND gates of up to five inputs are available in any combination of inverting and non-inverting inputs. NAND gates of six to nine inputs, 12 inputs, and 16 inputs are available with only non-inverting inputs. To invert inputs, use external inverters. Because each input uses a CLB resource, replace gates with unused inputs with gates having the necessary number of inputs.

Logic Table

Input	Output
I0 ... Iz	O
All inputs are 1	0
Any single input is 0	1

Design Entry Method

This design element is only for use in schematics.

For More Information

- See the [Spartan-3 Generation FPGA User Guide \(UG331\)](#).
- See the [Spartan-3E FPGA Family Data Sheet \(DS312\)](#).

NAND2B1

Primitive: 2-Input NAND Gate with 1 Inverted and 1 Non-Inverted Inputs

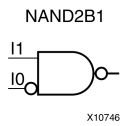

Introduction

NAND elements implement Negated AND or NOT AND. A High (1) output results when one or more inputs are a Low (0). A Low (0) output results only if all inputs are High (1).

NAND gates of up to five inputs are available in any combination of inverting and non-inverting inputs. NAND gates of six to nine inputs, 12 inputs, and 16 inputs are available with only non-inverting inputs. To invert inputs, use external inverters. Because each input uses a CLB resource, replace gates with unused inputs with gates having the necessary number of inputs.

Design Entry Method

This design element is only for use in schematics.

For More Information

- See the [Spartan-3 Generation FPGA User Guide \(UG331\)](#).
- See the [Spartan-3E FPGA Family Data Sheet \(DS312\)](#).

NAND2B2

Primitive: 2-Input NAND Gate with Inverted Inputs

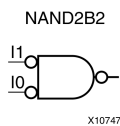

Introduction

NAND elements implement Negated AND or NOT AND. A High (1) output results when one or more inputs are a Low (0). A Low (0) output results only if all inputs are High (1).

NAND gates of up to five inputs are available in any combination of inverting and non-inverting inputs. NAND gates of six to nine inputs, 12 inputs, and 16 inputs are available with only non-inverting inputs. To invert inputs, use external inverters. Because each input uses a CLB resource, replace gates with unused inputs with gates having the necessary number of inputs.

Design Entry Method

This design element is only for use in schematics.

For More Information

- See the [Spartan-3 Generation FPGA User Guide \(UG331\)](#).
- See the [Spartan-3E FPGA Family Data Sheet \(DS312\)](#).

NAND3

Primitive: 3-Input NAND Gate with Non-Inverted Inputs

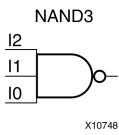

Introduction

NAND elements implement Negated AND or NOT AND. A High (1) output results when one or more inputs are a Low (0). A Low (0) output results only if all inputs are High (1).

NAND gates of up to five inputs are available in any combination of inverting and non-inverting inputs. NAND gates of six to nine inputs, 12 inputs, and 16 inputs are available with only non-inverting inputs. To invert inputs, use external inverters. Because each input uses a CLB resource, replace gates with unused inputs with gates having the necessary number of inputs.

Logic Table

Input	Output
I0 ... Iz	0
All inputs are 1	0
Any single input is 0	1

Design Entry Method

This design element is only for use in schematics.

For More Information

- See the [Spartan-3 Generation FPGA User Guide \(UG331\)](#).
- See the [Spartan-3E FPGA Family Data Sheet \(DS312\)](#).

NAND3B1

Primitive: 3-Input NAND Gate with 1 Inverted and 2 Non-Inverted Inputs

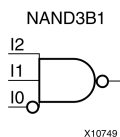

Introduction

NAND elements implement Negated AND or NOT AND. A High (1) output results when one or more inputs are a Low (0). A Low (0) output results only if all inputs are High (1).

NAND gates of up to five inputs are available in any combination of inverting and non-inverting inputs. NAND gates of six to nine inputs, 12 inputs, and 16 inputs are available with only non-inverting inputs. To invert inputs, use external inverters. Because each input uses a CLB resource, replace gates with unused inputs with gates having the necessary number of inputs.

Design Entry Method

This design element is only for use in schematics.

For More Information

- See the [Spartan-3 Generation FPGA User Guide \(UG331\)](#).
- See the [Spartan-3E FPGA Family Data Sheet \(DS312\)](#).

NAND3B2

Primitive: 3-Input NAND Gate with 2 Inverted and 1 Non-Inverted Inputs

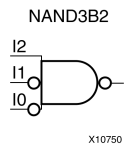

Introduction

NAND elements implement Negated AND or NOT AND. A High (1) output results when one or more inputs are a Low (0). A Low (0) output results only if all inputs are High (1).

NAND gates of up to five inputs are available in any combination of inverting and non-inverting inputs. NAND gates of six to nine inputs, 12 inputs, and 16 inputs are available with only non-inverting inputs. To invert inputs, use external inverters. Because each input uses a CLB resource, replace gates with unused inputs with gates having the necessary number of inputs.

Design Entry Method

This design element is only for use in schematics.

For More Information

- See the [Spartan-3 Generation FPGA User Guide \(UG331\)](#).
- See the [Spartan-3E FPGA Family Data Sheet \(DS312\)](#).

NAND3B3

Primitive: 3-Input NAND Gate with Inverted Inputs

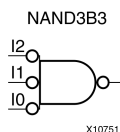

Introduction

NAND elements implement Negated AND or NOT AND. A High (1) output results when one or more inputs are a Low (0). A Low (0) output results only if all inputs are High (1).

NAND gates of up to five inputs are available in any combination of inverting and non-inverting inputs. NAND gates of six to nine inputs, 12 inputs, and 16 inputs are available with only non-inverting inputs. To invert inputs, use external inverters. Because each input uses a CLB resource, replace gates with unused inputs with gates having the necessary number of inputs.

Design Entry Method

This design element is only for use in schematics.

For More Information

- See the [Spartan-3 Generation FPGA User Guide \(UG331\)](#).
- See the [Spartan-3E FPGA Family Data Sheet \(DS312\)](#).

NAND4

Primitive: 4-Input NAND Gate with Non-Inverted Inputs

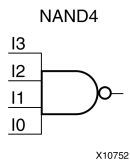

Introduction

NAND elements implement Negated AND or NOT AND. A High (1) output results when one or more inputs are a Low (0). A Low (0) output results only if all inputs are High (1).

NAND gates of up to five inputs are available in any combination of inverting and non-inverting inputs. NAND gates of six to nine inputs, 12 inputs, and 16 inputs are available with only non-inverting inputs. To invert inputs, use external inverters. Because each input uses a CLB resource, replace gates with unused inputs with gates having the necessary number of inputs.

Logic Table

Input	Output
I0 ... Iz	0
All inputs are 1	0
Any single input is 0	1

Design Entry Method

This design element is only for use in schematics.

For More Information

- See the [Spartan-3 Generation FPGA User Guide \(UG331\)](#).
- See the [Spartan-3E FPGA Family Data Sheet \(DS312\)](#).

NAND4B1

Primitive: 4-Input NAND Gate with 1 Inverted and 3 Non-Inverted Inputs

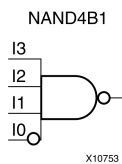

Introduction

NAND elements implement Negated AND or NOT AND. A High (1) output results when one or more inputs are a Low (0). A Low (0) output results only if all inputs are High (1).

NAND gates of up to five inputs are available in any combination of inverting and non-inverting inputs. NAND gates of six to nine inputs, 12 inputs, and 16 inputs are available with only non-inverting inputs. To invert inputs, use external inverters. Because each input uses a CLB resource, replace gates with unused inputs with gates having the necessary number of inputs.

Design Entry Method

This design element is only for use in schematics.

For More Information

- See the [Spartan-3 Generation FPGA User Guide \(UG331\)](#).
- See the [Spartan-3E FPGA Family Data Sheet \(DS312\)](#).

NAND4B2

Primitive: 4-Input NAND Gate with 2 Inverted and 2 Non-Inverted Inputs

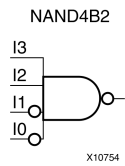

Introduction

NAND elements implement Negated AND or NOT AND. A High (1) output results when one or more inputs are a Low (0). A Low (0) output results only if all inputs are High (1).

NAND gates of up to five inputs are available in any combination of inverting and non-inverting inputs. NAND gates of six to nine inputs, 12 inputs, and 16 inputs are available with only non-inverting inputs. To invert inputs, use external inverters. Because each input uses a CLB resource, replace gates with unused inputs with gates having the necessary number of inputs.

Design Entry Method

This design element is only for use in schematics.

For More Information

- See the [Spartan-3 Generation FPGA User Guide \(UG331\)](#).
- See the [Spartan-3E FPGA Family Data Sheet \(DS312\)](#).

NAND4B3

Primitive: 4-Input NAND Gate with 3 Inverted and 1 Non-Inverted Inputs

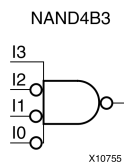

Introduction

NAND elements implement Negated AND or NOT AND. A High (1) output results when one or more inputs are a Low (0). A Low (0) output results only if all inputs are High (1).

NAND gates of up to five inputs are available in any combination of inverting and non-inverting inputs. NAND gates of six to nine inputs, 12 inputs, and 16 inputs are available with only non-inverting inputs. To invert inputs, use external inverters. Because each input uses a CLB resource, replace gates with unused inputs with gates having the necessary number of inputs.

Design Entry Method

This design element is only for use in schematics.

For More Information

- See the [Spartan-3 Generation FPGA User Guide \(UG331\)](#).
- See the [Spartan-3E FPGA Family Data Sheet \(DS312\)](#).

NAND4B4

Primitive: 4-Input NAND Gate with Inverted Inputs

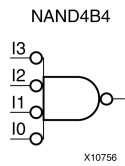

Introduction

NAND elements implement Negated AND or NOT AND. A High (1) output results when one or more inputs are a Low (0). A Low (0) output results only if all inputs are High (1).

NAND gates of up to five inputs are available in any combination of inverting and non-inverting inputs. NAND gates of six to nine inputs, 12 inputs, and 16 inputs are available with only non-inverting inputs. To invert inputs, use external inverters. Because each input uses a CLB resource, replace gates with unused inputs with gates having the necessary number of inputs.

Design Entry Method

This design element is only for use in schematics.

For More Information

- See the [Spartan-3 Generation FPGA User Guide \(UG331\)](#).
- See the [Spartan-3E FPGA Family Data Sheet \(DS312\)](#).

NAND5

Primitive: 5-Input NAND Gate with Non-Inverted Inputs

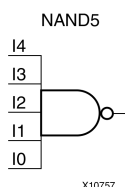

Introduction

NAND elements implement Negated AND or NOT AND. A High (1) output results when one or more inputs are a Low (0). A Low (0) output results only if all inputs are High (1).

NAND gates of up to five inputs are available in any combination of inverting and non-inverting inputs. NAND gates of six to nine inputs, 12 inputs, and 16 inputs are available with only non-inverting inputs. To invert inputs, use external inverters. Because each input uses a CLB resource, replace gates with unused inputs with gates having the necessary number of inputs.

Logic Table

Input	Output
I0 ... Iz	O
All inputs are 1	0
Any single input is 0	1

Design Entry Method

This design element is only for use in schematics.

For More Information

- See the [Spartan-3 Generation FPGA User Guide \(UG331\)](#).
- See the [Spartan-3E FPGA Family Data Sheet \(DS312\)](#).

NAND5B1

Primitive: 5-Input NAND Gate with 1 Inverted and 4 Non-Inverted Inputs

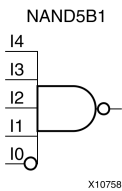

Introduction

NAND elements implement Negated AND or NOT AND. A High (1) output results when one or more inputs are a Low (0). A Low (0) output results only if all inputs are High (1).

NAND gates of up to five inputs are available in any combination of inverting and non-inverting inputs. NAND gates of six to nine inputs, 12 inputs, and 16 inputs are available with only non-inverting inputs. To invert inputs, use external inverters. Because each input uses a CLB resource, replace gates with unused inputs with gates having the necessary number of inputs.

Design Entry Method

This design element is only for use in schematics.

For More Information

- See the [Spartan-3 Generation FPGA User Guide \(UG331\)](#).
- See the [Spartan-3E FPGA Family Data Sheet \(DS312\)](#).

NAND5B2

Primitive: 5-Input NAND Gate with 2 Inverted and 3 Non-Inverted Inputs

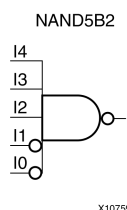

Introduction

NAND elements implement Negated AND or NOT AND. A High (1) output results when one or more inputs are a Low (0). A Low (0) output results only if all inputs are High (1).

NAND gates of up to five inputs are available in any combination of inverting and non-inverting inputs. NAND gates of six to nine inputs, 12 inputs, and 16 inputs are available with only non-inverting inputs. To invert inputs, use external inverters. Because each input uses a CLB resource, replace gates with unused inputs with gates having the necessary number of inputs.

Design Entry Method

This design element is only for use in schematics.

For More Information

- See the [Spartan-3 Generation FPGA User Guide \(UG331\)](#).
- See the [Spartan-3E FPGA Family Data Sheet \(DS312\)](#).

NAND5B3

Primitive: 5-Input NAND Gate with 3 Inverted and 2 Non-Inverted Inputs

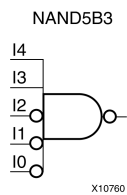

Introduction

NAND gates of up to five inputs are available in any combination of inverting and non-inverting inputs. NAND gates of six to nine inputs, 12 inputs, and 16 inputs are available with only non-inverting inputs. To invert inputs, use external inverters. Because each input uses a CLB resource, replace gates with unused inputs with gates having the necessary number of inputs.

Design Entry Method

This design element is only for use in schematics.

For More Information

- See the [Spartan-3 Generation FPGA User Guide \(UG331\)](#).
- See the [Spartan-3E FPGA Family Data Sheet \(DS312\)](#).

NAND5B4

Primitive: 5-Input NAND Gate with 4 Inverted and 1 Non-Inverted Inputs

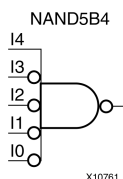

Introduction

NAND elements implement Negated AND or NOT AND. A High (1) output results when one or more inputs are a Low (0). A Low (0) output results only if all inputs are High (1).

NAND gates of up to five inputs are available in any combination of inverting and non-inverting inputs. NAND gates of six to nine inputs, 12 inputs, and 16 inputs are available with only non-inverting inputs. To invert inputs, use external inverters. Because each input uses a CLB resource, replace gates with unused inputs with gates having the necessary number of inputs.

Design Entry Method

This design element is only for use in schematics.

For More Information

- See the [Spartan-3 Generation FPGA User Guide \(UG331\)](#).
- See the [Spartan-3E FPGA Family Data Sheet \(DS312\)](#).

NAND5B5

Primitive: 5-Input NAND Gate with Inverted Inputs

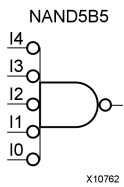

Introduction

NAND elements implement Negated AND or NOT AND. A High (1) output results when one or more inputs are a Low (0). A Low (0) output results only if all inputs are High (1).

NAND gates of up to five inputs are available in any combination of inverting and non-inverting inputs. NAND gates of six to nine inputs, 12 inputs, and 16 inputs are available with only non-inverting inputs. To invert inputs, use external inverters. Because each input uses a CLB resource, replace gates with unused inputs with gates having the necessary number of inputs.

Design Entry Method

This design element is only for use in schematics.

For More Information

- See the [Spartan-3 Generation FPGA User Guide \(UG331\)](#).
- See the [Spartan-3E FPGA Family Data Sheet \(DS312\)](#).

NAND6

Macro: 6-Input NAND Gate with Non-Inverted Inputs

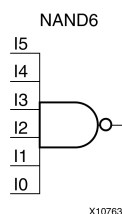

Introduction

NAND elements implement Negated AND or NOT AND. A High (1) output results when one or more inputs are a Low (0). A Low (0) output results only if all inputs are High (1).

NAND gates of up to five inputs are available in any combination of inverting and non-inverting inputs. NAND gates of six to nine inputs, 12 inputs, and 16 inputs are available with only non-inverting inputs. To invert inputs, use external inverters. Because each input uses a CLB resource, replace gates with unused inputs with gates having the necessary number of inputs.

Logic Table

Input	Output
I0 ... Iz	0
All inputs are 1	1
Any single input is 0	0

Design Entry Method

This design element is only for use in schematics.

For More Information

- See the [Spartan-3 Generation FPGA User Guide \(UG331\)](#).
- See the [Spartan-3E FPGA Family Data Sheet \(DS312\)](#).

NAND7

Macro: 7-Input NAND Gate with Non-Inverted Inputs

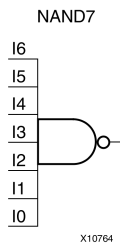

Introduction

NAND elements implement Negated AND or NOT AND. A High (1) output results when one or more inputs are a Low (0). A Low (0) output results only if all inputs are High (1).

NAND gates of up to five inputs are available in any combination of inverting and non-inverting inputs. NAND gates of six to nine inputs, 12 inputs, and 16 inputs are available with only non-inverting inputs. To invert inputs, use external inverters. Because each input uses a CLB resource, replace gates with unused inputs with gates having the necessary number of inputs.

Logic Table

Input	Output
I0 ... Iz	0
All inputs are 1	1
Any single input is 0	0

Design Entry Method

This design element is only for use in schematics.

For More Information

- See the [Spartan-3 Generation FPGA User Guide \(UG331\)](#).
- See the [Spartan-3E FPGA Family Data Sheet \(DS312\)](#).

NAND8

Macro: 8-Input NAND Gate with Non-Inverted Inputs

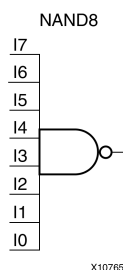

Introduction

NAND elements implement Negated AND or NOT AND. A High (1) output results when one or more inputs are a Low (0). A Low (0) output results only if all inputs are High (1).

NAND gates of up to five inputs are available in any combination of inverting and non-inverting inputs. NAND gates of six to nine inputs, 12 inputs, and 16 inputs are available with only non-inverting inputs. To invert inputs, use external inverters. Because each input uses a CLB resource, replace gates with unused inputs with gates having the necessary number of inputs.

Logic Table

Input	Output
I0 ... Iz	O
All inputs are 1	0
Any single input is 0	1

Design Entry Method

This design element is only for use in schematics.

For More Information

- See the [Spartan-3 Generation FPGA User Guide \(UG331\)](#).
- See the [Spartan-3E FPGA Family Data Sheet \(DS312\)](#).

NAND9

Macro: 9-Input NAND Gate with Non-Inverted Inputs

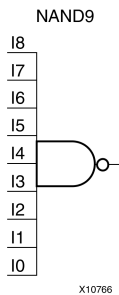

Introduction

NAND elements implement Negated AND or NOT AND. A High (1) output results when one or more inputs are a Low (0). A Low (0) output results only if all inputs are High (1).

NAND gates of up to five inputs are available in any combination of inverting and non-inverting inputs. NAND gates of six to nine inputs, 12 inputs, and 16 inputs are available with only non-inverting inputs. To invert inputs, use external inverters. Because each input uses a CLB resource, replace gates with unused inputs with gates having the necessary number of inputs.

Logic Table

Input	Output
I0 ... Iz	0
All inputs are 1	0
Any single input is 0	1

Design Entry Method

This design element is only for use in schematics.

For More Information

- See the [Spartan-3 Generation FPGA User Guide \(UG331\)](#).
- See the [Spartan-3E FPGA Family Data Sheet \(DS312\)](#).

NOR12

Macro: 12-Input NOR Gate with Non-Inverted Inputs

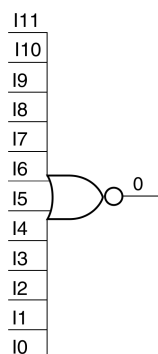

NOR12

X9433

Introduction

NOR elements implement Negated OR, or NOT OR. A High (1) output results only when all inputs to the element are Low (0). A Low (0) output results if any inputs are high (1).

NOR gates of up to five inputs are available in any combination of inverting and non-inverting inputs. NOR gates of six to nine inputs, 12 inputs, and 16 inputs are available only with non-inverting inputs. To invert some or all inputs, use external inverters. Because each input uses a CLB resource, replace gates with unused inputs with gates having the necessary number of inputs.

Logic Table

Input	Output
$I_0 \dots I_z$	O
Any input is 1	0
All inputs are 0	1

Design Entry Method

This design element is only for use in schematics.

For More Information

- See the [Spartan-3 Generation FPGA User Guide \(UG331\)](#).
- See the [Spartan-3E FPGA Family Data Sheet \(DS312\)](#).

NOR16

Macro: 16-Input NOR Gate with Non-Inverted Inputs

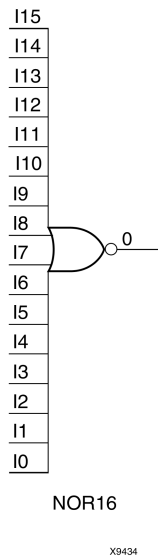

Introduction

NOR elements implement Negated OR, or NOT OR. A High (1) output results only when all inputs to the element are Low (0). A Low (0) output results if any inputs are high (1).

NOR gates of up to five inputs are available in any combination of inverting and non-inverting inputs. NOR gates of six to nine inputs, 12 inputs, and 16 inputs are available only with non-inverting inputs. To invert some or all inputs, use external inverters. Because each input uses a CLB resource, replace gates with unused inputs with gates having the necessary number of inputs.

Logic Table

Input	Output
I0 ... Iz	O
Any input is 1	0
All inputs are 0	1

Design Entry Method

This design element is only for use in schematics.

For More Information

- See the [Spartan-3 Generation FPGA User Guide \(UG331\)](#).
- See the [Spartan-3E FPGA Family Data Sheet \(DS312\)](#).

NOR2

Primitive: 2-Input NOR Gate with Non-Inverted Inputs

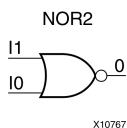

Introduction

NOR elements implement Negated OR, or NOT OR. A High (1) output results only when all inputs to the element are Low (0). A Low (0) output results if any inputs are high (1).

NOR gates of up to five inputs are available in any combination of inverting and non-inverting inputs. NOR gates of six to nine inputs, 12 inputs, and 16 inputs are available only with non-inverting inputs. To invert some or all inputs, use external inverters. Because each input uses a CLB resource, replace gates with unused inputs with gates having the necessary number of inputs.

Logic Table

Input	Output
I0 ... Iz	0
Any input is 1	0
All inputs are 0	1

Design Entry Method

This design element is only for use in schematics.

For More Information

- See the [Spartan-3 Generation FPGA User Guide \(UG331\)](#).
- See the [Spartan-3E FPGA Family Data Sheet \(DS312\)](#).

NOR2B1

Primitive: 2-Input NOR Gate with 1 Inverted and 1 Non-Inverted Inputs

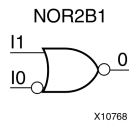

Introduction

NOR elements implement Negated OR, or NOT OR. A High (1) output results only when all inputs to the element are Low (0). A Low (0) output results if any inputs are high (1).

NOR gates of up to five inputs are available in any combination of inverting and non-inverting inputs. NOR gates of six to nine inputs, 12 inputs, and 16 inputs are available only with non-inverting inputs. To invert some or all inputs, use external inverters. Because each input uses a CLB resource, replace gates with unused inputs with gates having the necessary number of inputs.

Design Entry Method

This design element is only for use in schematics.

For More Information

- See the [Spartan-3 Generation FPGA User Guide \(UG331\)](#).
- See the [Spartan-3E FPGA Family Data Sheet \(DS312\)](#).

NOR2B2

Primitive: 2-Input NOR Gate with Inverted Inputs

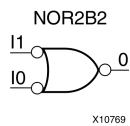

Introduction

NOR elements implement Negated OR, or NOT OR. A High (1) output results only when all inputs to the element are Low (0). A Low (0) output results if any inputs are high (1).

NOR gates of up to five inputs are available in any combination of inverting and non-inverting inputs. NOR gates of six to nine inputs, 12 inputs, and 16 inputs are available only with non-inverting inputs. To invert some or all inputs, use external inverters. Because each input uses a CLB resource, replace gates with unused inputs with gates having the necessary number of inputs.

Design Entry Method

This design element is only for use in schematics.

For More Information

- See the [Spartan-3 Generation FPGA User Guide \(UG331\)](#).
- See the [Spartan-3E FPGA Family Data Sheet \(DS312\)](#).

NOR3

Primitive: 3-Input NOR Gate with Non-Inverted Inputs

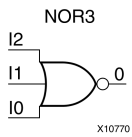

Introduction

NOR elements implement Negated OR, or NOT OR. A High (1) output results only when all inputs to the element are Low (0). A Low (0) output results if any inputs are high (1).

NOR gates of up to five inputs are available in any combination of inverting and non-inverting inputs. NOR gates of six to nine inputs, 12 inputs, and 16 inputs are available only with non-inverting inputs. To invert some or all inputs, use external inverters. Because each input uses a CLB resource, replace gates with unused inputs with gates having the necessary number of inputs.

Logic Table

Input	Output
I0 ... Iz	0
Any input is 1	0
All inputs are 0	1

Design Entry Method

This design element is only for use in schematics.

For More Information

- See the [Spartan-3 Generation FPGA User Guide \(UG331\)](#).
- See the [Spartan-3E FPGA Family Data Sheet \(DS312\)](#).

NOR3B1

Primitive: 3-Input NOR Gate with 1 Inverted and 2 Non-Inverted Inputs

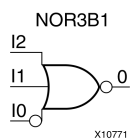

Introduction

NOR elements implement Negated OR, or NOT OR. A High (1) output results only when all inputs to the element are Low (0). A Low (0) output results if any inputs are high (1).

NOR gates of up to five inputs are available in any combination of inverting and non-inverting inputs. NOR gates of six to nine inputs, 12 inputs, and 16 inputs are available only with non-inverting inputs. To invert some or all inputs, use external inverters. Because each input uses a CLB resource, replace gates with unused inputs with gates having the necessary number of inputs.

Design Entry Method

This design element is only for use in schematics.

For More Information

- See the [Spartan-3 Generation FPGA User Guide \(UG331\)](#).
- See the [Spartan-3E FPGA Family Data Sheet \(DS312\)](#).

NOR3B2

Primitive: 3-Input NOR Gate with 2 Inverted and 1 Non-Inverted Inputs

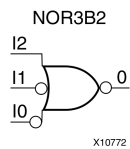

Introduction

NOR elements implement Negated OR, or NOT OR. A High (1) output results only when all inputs to the element are Low (0). A Low (0) output results if any inputs are high (1).

NOR gates of up to five inputs are available in any combination of inverting and non-inverting inputs. NOR gates of six to nine inputs, 12 inputs, and 16 inputs are available only with non-inverting inputs. To invert some or all inputs, use external inverters. Because each input uses a CLB resource, replace gates with unused inputs with gates having the necessary number of inputs.

Design Entry Method

This design element is only for use in schematics.

For More Information

- See the [Spartan-3 Generation FPGA User Guide \(UG331\)](#).
- See the [Spartan-3E FPGA Family Data Sheet \(DS312\)](#).

NOR3B3

Primitive: 3-Input NOR Gate with Inverted Inputs

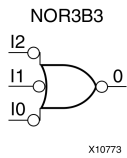

Introduction

NOR elements implement Negated OR, or NOT OR. A High (1) output results only when all inputs to the element are Low (0). A Low (0) output results if any inputs are high (1).

NOR gates of up to five inputs are available in any combination of inverting and non-inverting inputs. NOR gates of six to nine inputs, 12 inputs, and 16 inputs are available only with non-inverting inputs. To invert some or all inputs, use external inverters. Because each input uses a CLB resource, replace gates with unused inputs with gates having the necessary number of inputs.

Design Entry Method

This design element is only for use in schematics.

For More Information

- See the [Spartan-3 Generation FPGA User Guide \(UG331\)](#).
- See the [Spartan-3E FPGA Family Data Sheet \(DS312\)](#).

NOR4

Primitive: 4-Input NOR Gate with Non-Inverted Inputs

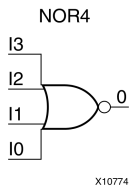

Introduction

NOR elements implement Negated OR, or NOT OR. A High (1) output results only when all inputs to the element are Low (0). A Low (0) output results if any inputs are high (1).

NOR gates of up to five inputs are available in any combination of inverting and non-inverting inputs. NOR gates of six to nine inputs, 12 inputs, and 16 inputs are available only with non-inverting inputs. To invert some or all inputs, use external inverters. Because each input uses a CLB resource, replace gates with unused inputs with gates having the necessary number of inputs.

Logic Table

Input	Output
I0 ... Iz	0
Any input is 1	0
All inputs are 0	1

Design Entry Method

This design element is only for use in schematics.

For More Information

- See the [Spartan-3 Generation FPGA User Guide \(UG331\)](#).
- See the [Spartan-3E FPGA Family Data Sheet \(DS312\)](#).

NOR4B1

Primitive: 4-Input NOR Gate with 1 Inverted and 3 Non-Inverted Inputs

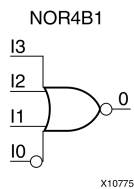

Introduction

NOR elements implement Negated OR, or NOT OR. A High (1) output results only when all inputs to the element are Low (0). A Low (0) output results if any inputs are high (1).

NOR gates of up to five inputs are available in any combination of inverting and non-inverting inputs. NOR gates of six to nine inputs, 12 inputs, and 16 inputs are available only with non-inverting inputs. To invert some or all inputs, use external inverters. Because each input uses a CLB resource, replace gates with unused inputs with gates having the necessary number of inputs.

Design Entry Method

This design element is only for use in schematics.

For More Information

- See the [Spartan-3 Generation FPGA User Guide \(UG331\)](#).
- See the [Spartan-3E FPGA Family Data Sheet \(DS312\)](#).

NOR4B2

Primitive: 4-Input NOR Gate with 2 Inverted and 2 Non-Inverted Inputs

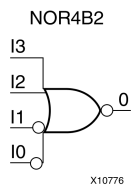

Introduction

NOR elements implement Negated OR, or NOT OR. A High (1) output results only when all inputs to the element are Low (0). A Low (0) output results if any inputs are high (1).

NOR gates of up to five inputs are available in any combination of inverting and non-inverting inputs. NOR gates of six to nine inputs, 12 inputs, and 16 inputs are available only with non-inverting inputs. To invert some or all inputs, use external inverters. Because each input uses a CLB resource, replace gates with unused inputs with gates having the necessary number of inputs.

Design Entry Method

This design element is only for use in schematics.

For More Information

- See the [Spartan-3 Generation FPGA User Guide \(UG331\)](#).
- See the [Spartan-3E FPGA Family Data Sheet \(DS312\)](#).

NOR4B3

Primitive: 4-Input NOR Gate with 3 Inverted and 1 Non-Inverted Inputs

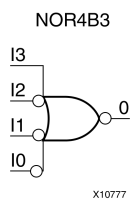

Introduction

NOR elements implement Negated OR, or NOT OR. A High (1) output results only when all inputs to the element are Low (0). A Low (0) output results if any inputs are high (1).

NOR gates of up to five inputs are available in any combination of inverting and non-inverting inputs. NOR gates of six to nine inputs, 12 inputs, and 16 inputs are available only with non-inverting inputs. To invert some or all inputs, use external inverters. Because each input uses a CLB resource, replace gates with unused inputs with gates having the necessary number of inputs.

Design Entry Method

This design element is only for use in schematics.

For More Information

- See the [Spartan-3 Generation FPGA User Guide \(UG331\)](#).
- See the [Spartan-3E FPGA Family Data Sheet \(DS312\)](#).

NOR4B4

Primitive: 4-Input NOR Gate with Inverted Inputs

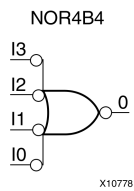

Introduction

NOR elements implement Negated OR, or NOT OR. A High (1) output results only when all inputs to the element are Low (0). A Low (0) output results if any inputs are high (1).

NOR gates of up to five inputs are available in any combination of inverting and non-inverting inputs. NOR gates of six to nine inputs, 12 inputs, and 16 inputs are available only with non-inverting inputs. To invert some or all inputs, use external inverters. Because each input uses a CLB resource, replace gates with unused inputs with gates having the necessary number of inputs.

Design Entry Method

This design element is only for use in schematics.

For More Information

- See the [Spartan-3 Generation FPGA User Guide \(UG331\)](#).
- See the [Spartan-3E FPGA Family Data Sheet \(DS312\)](#).

NOR5

Primitive: 5-Input NOR Gate with Non-Inverted Inputs

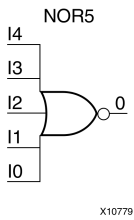

Introduction

NOR elements implement Negated OR, or NOT OR. A High (1) output results only when all inputs to the element are Low (0). A Low (0) output results if any inputs are high (1).

NOR gates of up to five inputs are available in any combination of inverting and non-inverting inputs. NOR gates of six to nine inputs, 12 inputs, and 16 inputs are available only with non-inverting inputs. To invert some or all inputs, use external inverters. Because each input uses a CLB resource, replace gates with unused inputs with gates having the necessary number of inputs.

Logic Table

Input	Output
I0 ... Iz	0
Any input is 1	0
All inputs are 0	1

Design Entry Method

This design element is only for use in schematics.

For More Information

- See the [Spartan-3 Generation FPGA User Guide \(UG331\)](#).
- See the [Spartan-3E FPGA Family Data Sheet \(DS312\)](#).

NOR5B1

Primitive: 5-Input NOR Gate with 1 Inverted and 4 Non-Inverted Inputs

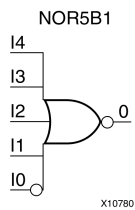

Introduction

NOR elements implement Negated OR, or NOT OR. A High (1) output results only when all inputs to the element are Low (0). A Low (0) output results if any inputs are high (1).

NOR gates of up to five inputs are available in any combination of inverting and non-inverting inputs. NOR gates of six to nine inputs, 12 inputs, and 16 inputs are available only with non-inverting inputs. To invert some or all inputs, use external inverters. Because each input uses a CLB resource, replace gates with unused inputs with gates having the necessary number of inputs.

Design Entry Method

This design element is only for use in schematics.

For More Information

- See the [Spartan-3 Generation FPGA User Guide \(UG331\)](#).
- See the [Spartan-3E FPGA Family Data Sheet \(DS312\)](#).

NOR5B2

Primitive: 5-Input NOR Gate with 2 Inverted and 3 Non-Inverted Inputs

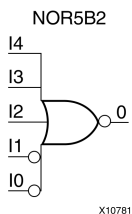

Introduction

NOR elements implement Negated OR, or NOT OR. A High (1) output results only when all inputs to the element are Low (0). A Low (0) output results if any inputs are high (1).

NOR gates of up to five inputs are available in any combination of inverting and non-inverting inputs. NOR gates of six to nine inputs, 12 inputs, and 16 inputs are available only with non-inverting inputs. To invert some or all inputs, use external inverters. Because each input uses a CLB resource, replace gates with unused inputs with gates having the necessary number of inputs.

Design Entry Method

This design element is only for use in schematics.

For More Information

- See the [Spartan-3 Generation FPGA User Guide \(UG331\)](#).
- See the [Spartan-3E FPGA Family Data Sheet \(DS312\)](#).

NOR5B3

Primitive: 5-Input NOR Gate with 3 Inverted and 2 Non-Inverted Inputs

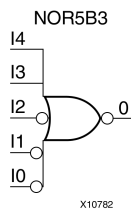

Introduction

NOR elements implement Negated OR, or NOT OR. A High (1) output results only when all inputs to the element are Low (0). A Low (0) output results if any inputs are high (1).

NOR gates of up to five inputs are available in any combination of inverting and non-inverting inputs. NOR gates of six to nine inputs, 12 inputs, and 16 inputs are available only with non-inverting inputs. To invert some or all inputs, use external inverters. Because each input uses a CLB resource, replace gates with unused inputs with gates having the necessary number of inputs.

Design Entry Method

This design element is only for use in schematics.

For More Information

- See the [Spartan-3 Generation FPGA User Guide \(UG331\)](#).
- See the [Spartan-3E FPGA Family Data Sheet \(DS312\)](#).

NOR5B4

Primitive: 5-Input NOR Gate with 4 Inverted and 1 Non-Inverted Inputs

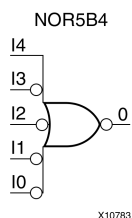

Introduction

NOR elements implement Negated OR, or NOT OR. A High (1) output results only when all inputs to the element are Low (0). A Low (0) output results if any inputs are high (1).

NOR gates of up to five inputs are available in any combination of inverting and non-inverting inputs. NOR gates of six to nine inputs, 12 inputs, and 16 inputs are available only with non-inverting inputs. To invert some or all inputs, use external inverters. Because each input uses a CLB resource, replace gates with unused inputs with gates having the necessary number of inputs.

Design Entry Method

This design element is only for use in schematics.

For More Information

- See the [Spartan-3 Generation FPGA User Guide \(UG331\)](#).
- See the [Spartan-3E FPGA Family Data Sheet \(DS312\)](#).

NOR5B5

Primitive: 5-Input NOR Gate with Inverted Inputs

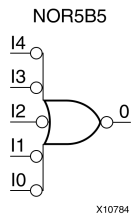

Introduction

NOR elements implement Negated OR, or NOT OR. A High (1) output results only when all inputs to the element are Low (0). A Low (0) output results if any inputs are high (1).

NOR gates of up to five inputs are available in any combination of inverting and non-inverting inputs. NOR gates of six to nine inputs, 12 inputs, and 16 inputs are available only with non-inverting inputs. To invert some or all inputs, use external inverters. Because each input uses a CLB resource, replace gates with unused inputs with gates having the necessary number of inputs.

Design Entry Method

This design element is only for use in schematics.

For More Information

- See the [Spartan-3 Generation FPGA User Guide \(UG331\)](#).
- See the [Spartan-3E FPGA Family Data Sheet \(DS312\)](#).

NOR6

Macro: 6-Input NOR Gate with Non-Inverted Inputs

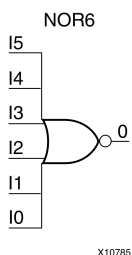

Introduction

NOR elements implement Negated OR, or NOT OR. A High (1) output results only when all inputs to the element are Low (0). A Low (0) output results if any inputs are high (1).

NOR gates of up to five inputs are available in any combination of inverting and non-inverting inputs. NOR gates of six to nine inputs, 12 inputs, and 16 inputs are available only with non-inverting inputs. To invert some or all inputs, use external inverters. Because each input uses a CLB resource, replace gates with unused inputs with gates having the necessary number of inputs.

Logic Table

Input	Output
I0 ... Iz	0
Any input is 1	0
All inputs are 0	1

Design Entry Method

This design element is only for use in schematics.

For More Information

- See the [Spartan-3 Generation FPGA User Guide \(UG331\)](#).
- See the [Spartan-3E FPGA Family Data Sheet \(DS312\)](#).

NOR7

Macro: 7-Input NOR Gate with Non-Inverted Inputs

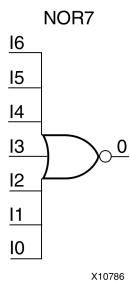

Introduction

NOR elements implement Negated OR, or NOT OR. A High (1) output results only when all inputs to the element are Low (0). A Low (0) output results if any inputs are high (1).

NOR gates of up to five inputs are available in any combination of inverting and non-inverting inputs. NOR gates of six to nine inputs, 12 inputs, and 16 inputs are available only with non-inverting inputs. To invert some or all inputs, use external inverters. Because each input uses a CLB resource, replace gates with unused inputs with gates having the necessary number of inputs.

Logic Table

Input	Output
I0 ... Iz	0
Any input is 1	0
All inputs are 0	1

Design Entry Method

This design element is only for use in schematics.

For More Information

- See the [Spartan-3 Generation FPGA User Guide \(UG331\)](#).
- See the [Spartan-3E FPGA Family Data Sheet \(DS312\)](#).

NOR8

Macro: 8-Input NOR Gate with Non-Inverted Inputs

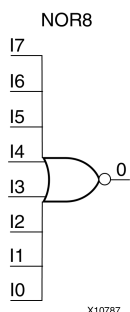

Introduction

NOR elements implement Negated OR, or NOT OR. A High (1) output results only when all inputs to the element are Low (0). A Low (0) output results if any inputs are high (1).

NOR gates of up to five inputs are available in any combination of inverting and non-inverting inputs. NOR gates of six to nine inputs, 12 inputs, and 16 inputs are available only with non-inverting inputs. To invert some or all inputs, use external inverters. Because each input uses a CLB resource, replace gates with unused inputs with gates having the necessary number of inputs.

Logic Table

Input	Output
I0 ... Iz	O
Any input is 1	0
All inputs are 0	1

Design Entry Method

This design element is only for use in schematics.

For More Information

- See the [Spartan-3 Generation FPGA User Guide \(UG331\)](#).
- See the [Spartan-3E FPGA Family Data Sheet \(DS312\)](#).

NOR9

Macro: 9-Input NOR Gate with Non-Inverted Inputs

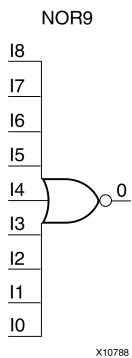

Introduction

NOR elements implement Negated OR, or NOT OR. A High (1) output results only when all inputs to the element are Low (0). A Low (0) output results if any inputs are high (1).

NOR gates of up to five inputs are available in any combination of inverting and non-inverting inputs. NOR gates of six to nine inputs, 12 inputs, and 16 inputs are available only with non-inverting inputs. To invert some or all inputs, use external inverters. Because each input uses a CLB resource, replace gates with unused inputs with gates having the necessary number of inputs.

Logic Table

Input	Output
I0 ... Iz	0
Any input is 1	0
All inputs are 0	1

Design Entry Method

This design element is only for use in schematics.

For More Information

- See the [Spartan-3 Generation FPGA User Guide \(UG331\)](#).
- See the [Spartan-3E FPGA Family Data Sheet \(DS312\)](#).

OBUF

Primitive: Output Buffer

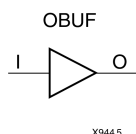

Introduction

This design element is a simple output buffer used to drive output signals to the FPGA device pins that do not need to be 3-stated (constantly driven). Either an OBUF, OBUFT, OBUFDS, or OBUFTDS must be connected to every output port in the design.

This element isolates the internal circuit and provides drive current for signals leaving a chip. It exists in input/output blocks (IOB). Its output (O) is connected to an OPAD or an IOPAD. The interface standard used by this element is LVTTTL. Also, this element has selectable drive and slew rates using the DRIVE and SLOW or FAST constraints. The defaults are DRIVE=12 mA and SLOW slew.

Port Descriptions

Port	Direction	Width	Function
O	Output	1	Output of OBUF to be connected directly to top-level output port.
I	Input	1	Input of OBUF. Connect to the logic driving the output port.

Design Entry Method

This design element can be used in schematics.

Available Attributes

Attribute	Data Type	Allowed Values	Default	Description
DRIVE	Integer	2, 4, 6, 8, 12, 16, 24	12	Specifies the output current drive strength of the I/O. It is suggested that you set this to the lowest setting tolerable for the design drive and timing requirements.
IOSTANDARD	String	See Data Sheet	"DEFAULT"	Assigns an I/O standard to the element.
SLEW	String	"SLOW" or "FAST"	"SLOW"	Specifies the slew rate of the output driver. Consult the product Data Sheet for recommendations of the best setting for this attribute.

For More Information

- See the [Spartan-3 Generation FPGA User Guide \(UG331\)](#).
- See the [Spartan-3E FPGA Family Data Sheet \(DS312\)](#).

OBUF16

Macro: 16-Bit Output Buffer

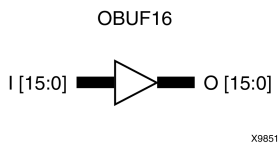

Introduction

This design element is a multiple output buffer.

This element isolates the internal circuit and provides drive current for signals leaving a chip. It exists in input/output blocks (IOB). Its output (O) is connected to an OPAD or an IOPAD. The interface standard used by this element is LVTTTL. Also, this element has selectable drive and slew rates using the DRIVE and SLOW or FAST constraints. The defaults are DRIVE=12 mA and SLOW slew.

Design Entry Method

This design element can be used in schematics.

Available Attributes

Attribute	Data Type	Allowed Values	Default	Description
DRIVE	Integer	2, 4, 6, 8, 12, 16, 24	12	Specifies the output current drive strength of the I/O. It is suggested that you set this to the lowest setting tolerable for the design drive and timing requirements.
IOSTANDARD	String	See Data Sheet	"DEFAULT"	Assigns an I/O standard to the element.
SLEW	String	"SLOW" or "FAST"	"SLOW"	Specifies the slew rate of the output driver. Consult the product Data Sheet for recommendations of the best setting for this attribute.

For More Information

- See the [Spartan-3 Generation FPGA User Guide \(UG331\)](#).
- See the [Spartan-3E FPGA Family Data Sheet \(DS312\)](#).

OBUF4

Macro: 4-Bit Output Buffer

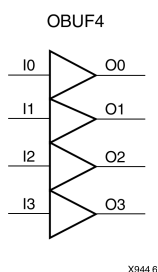

Introduction

This design element is a multiple output buffer.

This element isolates the internal circuit and provides drive current for signals leaving a chip. It exists in input/output blocks (IOB). Its output (O) is connected to an OPAD or an IOPAD. The interface standard used by this element is LVTTTL. Also, this element has selectable drive and slew rates using the DRIVE and SLOW or FAST constraints. The defaults are DRIVE=12 mA and SLOW slew.

Design Entry Method

This design element can be used in schematics.

Available Attributes

Attribute	Data Type	Allowed Values	Default	Description
DRIVE	Integer	2, 4, 6, 8, 12, 16, 24	12	Specifies the output current drive strength of the I/O. It is suggested that you set this to the lowest setting tolerable for the design drive and timing requirements.
IOSTANDARD	String	See Data Sheet	"DEFAULT"	Assigns an I/O standard to the element.
SLEW	String	"SLOW" or "FAST"	"SLOW"	Specifies the slew rate of the output driver. Consult the product Data Sheet for recommendations of the best setting for this attribute.

For More Information

- See the [Spartan-3 Generation FPGA User Guide \(UG331\)](#).
- See the [Spartan-3E FPGA Family Data Sheet \(DS312\)](#).

OBUF8

Macro: 8-Bit Output Buffer

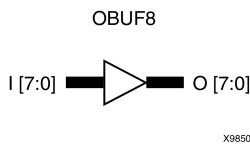

Introduction

This design element is a multiple output buffer.

This element isolates the internal circuit and provides drive current for signals leaving a chip. It exists in input/output blocks (IOB). Its output (O) is connected to an OPAD or an IOPAD. The interface standard used by this element is LVTTTL. Also, this element has selectable drive and slew rates using the DRIVE and SLOW or FAST constraints. The defaults are DRIVE=12 mA and SLOW slew.

Design Entry Method

This design element can be used in schematics.

Available Attributes

Attribute	Data Type	Allowed Values	Default	Description
DRIVE	Integer	2, 4, 6, 8, 12, 16, 24	12	Specifies the output current drive strength of the I/O. It is suggested that you set this to the lowest setting tolerable for the design drive and timing requirements.
IOSTANDARD	String	See Data Sheet	"DEFAULT"	Assigns an I/O standard to the element.
SLEW	String	"SLOW" or "FAST"	"SLOW"	Specifies the slew rate of the output driver. Consult the product Data Sheet for recommendations of the best setting for this attribute.

For More Information

- See the [Spartan-3 Generation FPGA User Guide \(UG331\)](#).
- See the [Spartan-3E FPGA Family Data Sheet \(DS312\)](#).

OBUFDS

Primitive: Differential Signaling Output Buffer

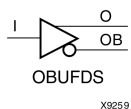

Introduction

This design element is a single output buffer that supports low-voltage, differential signaling (1.8 v CMOS). OBUFDS isolates the internal circuit and provides drive current for signals leaving the chip. Its output is represented as two distinct ports (O and OB), one deemed the "master" and the other the "slave." The master and the slave are opposite phases of the same logical signal (for example, MYNET and MYNETB).

Logic Table

Inputs	Outputs	
I	O	OB
0	0	1
1	1	0

Port Descriptions

Port	Direction	Width	Function
O	Output	1	Diff_p output (connect directly to top level port)
OB	Output	1	Diff_n output (connect directly to top level port)
I	Input	1	Buffer input

Design Entry Method

This design element can be used in schematics.

Available Attributes

Attribute	Data Type	Allowed Values	Default	Description
IOSTANDARD	String	See Data Sheet	"DEFAULT"	Assigns an I/O standard to the element.

For More Information

- See the [Spartan-3 Generation FPGA User Guide \(UG331\)](#).
- See the [Spartan-3E FPGA Family Data Sheet \(DS312\)](#).

OBUFT

Primitive: 3-State Output Buffer with Active Low Output Enable

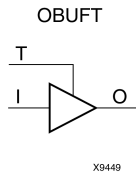

Introduction

This design element is a single, 3-state output buffer with input I, output O, and active-Low output enables (T). This element uses the LVTTTL standard and has selectable drive and slew rates using the DRIVE and SLOW or FAST constraints. The defaults are DRIVE=12 mA and SLOW slew.

When T is Low, data on the inputs of the buffers is transferred to the corresponding outputs. When T is High, the output is high impedance (off or Z state). OBUFTs are generally used when a single-ended output is needed with a 3-state capability, such as the case when building bidirectional I/O.

Logic Table

Inputs		Outputs
T	I	O
1	X	Z
0	1	1
0	0	0

Port Descriptions

Port	Direction	Width	Function
O	Output	1	Buffer output (connect directly to top-level port)
I	Input	1	Buffer input
T	Input	1	3-state enable input

Design Entry Method

This design element can be used in schematics.

Available Attributes

Attribute	Data Type	Allowed Values	Default	Description
DRIVE	Integer	2, 4, 6, 8, 12, 16, 24	12	Specifies the output current drive strength of the I/O. You should set this to the lowest setting tolerable for the design drive and timing requirements.
IOSTANDARD	String	See Data Sheet	"DEFAULT"	Assigns an I/O standard to the element.
SLEW	String	"SLOW" or "FAST"	"SLOW"	Specifies the slew rate of the output driver. See the Data Sheet for recommendations of the best setting for this attribute.

For More Information

- See the [Spartan-3 Generation FPGA User Guide \(UG331\)](#).
- See the [Spartan-3E FPGA Family Data Sheet \(DS312\)](#).

OBUFT16

Macro: 16-Bit 3-State Output Buffer with Active Low Output Enable

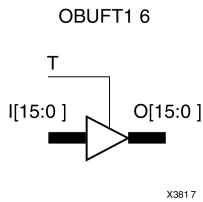

Introduction

This design element is a multiple, 3-state output buffer with input I, output O, and active-Low output enables (T). This element uses the LVTTL standard and has selectable drive and slew rates using the DRIVE and SLOW or FAST constraints. The defaults are DRIVE=12 mA and SLOW slew.

When T is Low, data on the inputs of the buffers is transferred to the corresponding outputs. When T is High, the output is high impedance (off or Z state). OBUFTs are generally used when a single-ended output is needed with a 3-state capability, such as the case when building bidirectional I/O.

Logic Table

Inputs		Outputs
T	I	O
1	X	Z
0	1	1
0	0	0

Design Entry Method

This design element is only for use in schematics.

Available Attributes

Attribute	Data Type	Allowed Values	Default	Description
DRIVE	Integer	2, 4, 6, 8, 12, 16, 24	12	Specifies the output current drive strength of the I/O. You should set this to the lowest setting tolerable for the design drive and timing requirements.
IOSTANDARD	String	See Data Sheet	"DEFAULT"	Assigns an I/O standard to the element.
SLEW	String	"SLOW" or "FAST"	"SLOW"	Specifies the slew rate of the output driver. See the Data Sheet for recommendations of the best setting for this attribute.

For More Information

- See the [Spartan-3 Generation FPGA User Guide \(UG331\)](#).
- See the [Spartan-3E FPGA Family Data Sheet \(DS312\)](#).

OBUFT4

Macro: 4-Bit 3-State Output Buffers with Active-Low Output Enable

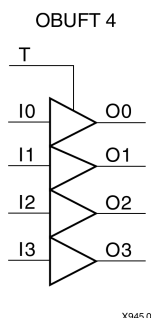

X9450

Introduction

This design element is a multiple, 3-state output buffer with input I, output O, and active-Low output enables (T). This element uses the LVTTTL standard and has selectable drive and slew rates using the DRIVE and SLOW or FAST constraints. The defaults are DRIVE=12 mA and SLOW slew.

When T is Low, data on the inputs of the buffers is transferred to the corresponding outputs. When T is High, the output is high impedance (off or Z state). OBUFTs are generally used when a single-ended output is needed with a 3-state capability, such as the case when building bidirectional I/O.

Logic Table

Inputs		Outputs
T	I	O
1	X	Z
0	1	1
0	0	0

Design Entry Method

This design element is only for use in schematics.

Available Attributes

Attribute	Data Type	Allowed Values	Default	Description
DRIVE	Integer	2, 4, 6, 8, 12, 16, 24	12	Specifies the output current drive strength of the I/O. You should set this to the lowest setting tolerable for the design drive and timing requirements.
IOSTANDARD	String	See Data Sheet	"DEFAULT"	Assigns an I/O standard to the element.
SLEW	String	"SLOW" or "FAST"	"SLOW"	Specifies the slew rate of the output driver. See the Data Sheet for recommendations of the best setting for this attribute.

For More Information

- See the [Spartan-3 Generation FPGA User Guide \(UG331\)](#).
- See the [Spartan-3E FPGA Family Data Sheet \(DS312\)](#).

OBUFT8

Macro: 8-Bit 3-State Output Buffers with Active-Low Output Enable

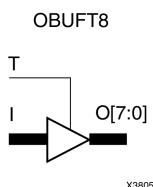

Introduction

This design element is a multiple, 3-state output buffer with input I, output O, and active-Low output enables (T). This element uses the LVTTTL standard and has selectable drive and slew rates using the DRIVE and SLOW or FAST constraints. The defaults are DRIVE=12 mA and SLOW slew.

When T is Low, data on the inputs of the buffers is transferred to the corresponding outputs. When T is High, the output is high impedance (off or Z state). OBUFTs are generally used when a single-ended output is needed with a 3-state capability, such as the case when building bidirectional I/O.

Logic Table

Inputs		Outputs
T	I	O
1	X	Z
0	1	1
0	0	0

Design Entry Method

This design element is only for use in schematics.

Available Attributes

Attribute	Data Type	Allowed Values	Default	Description
DRIVE	Integer	2, 4, 6, 8, 12, 16, 24	12	Specifies the output current drive strength of the I/O. You should set this to the lowest setting tolerable for the design drive and timing requirements.
IOSTANDARD	String	See Data Sheet	"DEFAULT"	Assigns an I/O standard to the element.
SLEW	String	"SLOW" or "FAST"	"SLOW"	Specifies the slew rate of the output driver. See the Data Sheet for recommendations of the best setting for this attribute.

For More Information

- See the [Spartan-3 Generation FPGA User Guide \(UG331\)](#).
- See the [Spartan-3E FPGA Family Data Sheet \(DS312\)](#).

OBUFTDS

Primitive: 3-State Output Buffer with Differential Signaling, Active-Low Output Enable

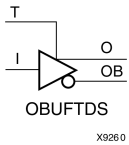

Introduction

This design element is an output buffer that supports low-voltage, differential signaling. For the OBUFTDS, a design level interface signal is represented as two distinct ports (O and OB), one deemed the "master" and the other the "slave." The master and the slave are opposite phases of the same logical signal (for example, MYNET_P and MYNET_N).

Logic Table

Inputs		Outputs	
I	T	O	OB
X	1	Z	Z
0	0	0	1
1	0	1	0

Port Descriptions

Port	Direction	Width	Function
O	Output	1	Diff_p output (connect directly to top level port)
OB	Output	1	Diff_n output (connect directly to top level port)
I	Input	1	Buffer input
T	Input	1	3-state enable input

Design Entry Method

This design element can be used in schematics.

Available Attributes

Attribute	Data Type	Allowed Values	Default	Description
IOSTANDARD	String	See Data Sheet	"DEFAULT"	Assigns an I/O standard to the element.

For More Information

- See the [Spartan-3 Generation FPGA User Guide \(UG331\)](#).
- See the [Spartan-3E FPGA Family Data Sheet \(DS312\)](#).

ODDR2

Primitive: Dual Data Rate Output D Flip-Flop with Optional Data Alignment, Clock Enable and Programmable Synchronous or Asynchronous Set/Reset

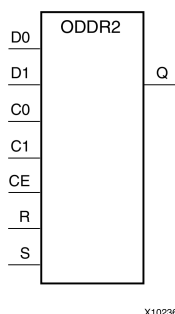

Introduction

The design element is an output double data rate (DDR) register useful in producing double data rate signals exiting the FPGA. The ODDR2 requires two clocks (C0 and C1) to be connected to the component so that data is provided at the positive edge of both clocks. The ODDR2 features an active high clock enable port, CE, which can be used to suspend the operation of the registers and both set and reset ports that can be configured to be synchronous or asynchronous to the respective clocks. The ODDR2 has an optional alignment feature, which allows data to be captured by a single clock and clocked out by two clocks.

Logic Table

Inputs							Outputs
S	R	CE	D0	D1	C0	C1	O
1	X	X	X	X	X	X	1
0	1	X	X	X	X	X	0
0	0	0	X	X	X	X	No Change
0	0	1	D0	X	↑	X	D0
0	0	1	X	D1	X	↑	D1

Set/Reset can be synchronous via SRTYPE value

Design Entry Method

This design element can be used in schematics.

Available Attributes

Attribute	Data Type	Allowed Values	Default	Descriptions
DDR_ALIGNMENT	String	"NONE", "C0", "C1"	"NONE"	<p>Sets the input capture behavior for the DDR register.</p> <ul style="list-style-type: none"> "NONE" clocks in data to the D0 input on the positive transition of the C0 clock and D1 on the positive transition of the C1 clock. "C0" allows the input clocking of both D0 and D1 align to the positive edge of the C0 clock. "C1" allows the input clocking of both D0 and D1 align to the positive edge of the C1 clock.
INIT	Binary	0, 1	0	Sets the initial state of the Q output to 0 or 1.
SRTYPE	String	"SYNC", "ASYNC"	"SYNC"	Specifies "SYNC" or "ASYNC" set/reset.

For More Information

- See the [Spartan-3 Generation FPGA User Guide \(UG331\)](#).
- See the [Spartan-3E FPGA Family Data Sheet \(DS312\)](#).

OFD

Macro: Output D Flip-Flop

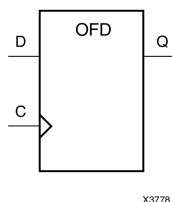

Introduction

This design element is a single output D flip-flop.

The outputs are connected to OPADs or IOPADs. The data on the (D) inputs is loaded into the flip-flops during the Low-to-High clock (C) transition and appears on the (Q) outputs.

This flip-flop is asynchronously cleared, outputs Low, when power is applied. For FPGA devices, power-on conditions are simulated when global set/reset (GSR) is active. GSR defaults to active-High but can be inverted by adding an inverter in front of the GSR input of the appropriate `STARTUP_architecture` symbol.

Logic Table

Inputs		Outputs
D	C	Q
D	↑	D

Design Entry Method

This design element is only for use in schematics.

For More Information

- See the [Spartan-3 Generation FPGA User Guide \(UG331\)](#).
- See the [Spartan-3E FPGA Family Data Sheet \(DS312\)](#).

OFD_1

Macro: Output D Flip-Flop with Inverted Clock

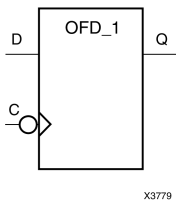

Introduction

The design element is located in an input/output block (IOB). The output (Q) of the D flip-flop is connected to an OPAD or an IOPAD. The data on the (D) input is loaded into the flip-flop during the High-to-Low clock (C) transition and appears on the (Q) output.

This flip-flop is asynchronously cleared, outputs Low, when power is applied. For FPGA devices, power-on conditions are simulated when global set/reset (GSR) is active. GSR defaults to active-High but can be inverted by adding an inverter in front of the GSR input of the appropriate `STARTUP_architecture` symbol.

Logic Table

Inputs		Outputs
D	C	Q
D	↓	D

Design Entry Method

This design element is only for use in schematics.

For More Information

- See the [Spartan-3 Generation FPGA User Guide \(UG331\)](#).
- See the [Spartan-3E FPGA Family Data Sheet \(DS312\)](#).

OFD16

Macro: 16-Bit Output D Flip-Flop

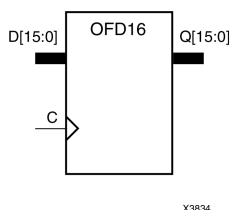

Introduction

This design element is a multiple output D flip-flop.

The outputs are connected to OPADs or IOPADs. The data on the (D) inputs is loaded into the flip-flops during the Low-to-High clock (C) transition and appears on the (Q) outputs.

This flip-flop is asynchronously cleared, outputs Low, when power is applied. For FPGA devices, power-on conditions are simulated when global set/reset (GSR) is active. GSR defaults to active-High but can be inverted by adding an inverter in front of the GSR input of the appropriate *STARTUP_architecture* symbol.

Logic Table

Inputs		Outputs
D	C	Q
D	↑	D

Design Entry Method

This design element is only for use in schematics.

For More Information

- See the [Spartan-3 Generation FPGA User Guide \(UG331\)](#).
- See the [Spartan-3E FPGA Family Data Sheet \(DS312\)](#).

OFD4

Macro: 4-Bit Output D Flip-Flop

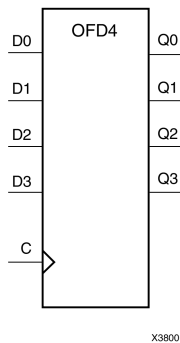

Introduction

This design element is a multiple output D flip-flop.

The outputs are connected to OPADs or IOPADs. The data on the (D) inputs is loaded into the flip-flops during the Low-to-High clock (C) transition and appears on the (Q) outputs.

This flip-flop is asynchronously cleared, outputs Low, when power is applied. For FPGA devices, power-on conditions are simulated when global set/reset (GSR) is active. GSR defaults to active-High but can be inverted by adding an inverter in front of the GSR input of the appropriate `STARTUP_architecture` symbol.

Logic Table

Inputs		Outputs
D	C	Q
D	↑	D

Design Entry Method

This design element is only for use in schematics.

For More Information

- See the [Spartan-3 Generation FPGA User Guide \(UG331\)](#).
- See the [Spartan-3E FPGA Family Data Sheet \(DS312\)](#).

OFD8

Macro: 8-Bit Output D Flip-Flop

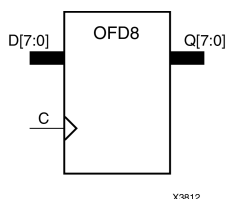

Introduction

This design element is a multiple output D flip-flop.

The outputs are connected to OPADs or IOPADs. The data on the (D) inputs is loaded into the flip-flops during the Low-to-High clock (C) transition and appears on the (Q) outputs.

This flip-flop is asynchronously cleared, outputs Low, when power is applied. For FPGA devices, power-on conditions are simulated when global set/reset (GSR) is active. GSR defaults to active-High but can be inverted by adding an inverter in front of the GSR input of the appropriate *STARTUP_architecture* symbol.

Logic Table

Inputs		Outputs
D	C	Q
D	↑	D

Design Entry Method

This design element is only for use in schematics.

For More Information

- See the [Spartan-3 Generation FPGA User Guide \(UG331\)](#).
- See the [Spartan-3E FPGA Family Data Sheet \(DS312\)](#).

OFDE

Macro: D Flip-Flop with Active-High Enable Output Buffers

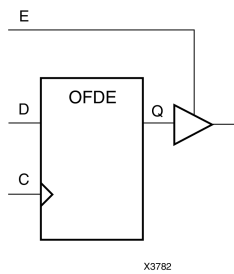

Introduction

This is a single D flip-flop whose output is enabled by a 3-state buffer. The flip-flop data output (Q) is connected to the input of output buffer (OBUFE). The OBUFE output (O) is connected to an OPAD or IOPAD. The data on the data input (D) is loaded into the flip-flop during the Low-to-High clock (C) transition. When the active-High enable input (E) is High, the data on the flip-flop output (Q) appears on the OBUFE (O) output. When (E) is Low, the output is high impedance (Z state or Off).

This flip-flop is asynchronously cleared, outputs Low, when power is applied. For FPGA devices, power-on conditions are simulated when global set/reset (GSR) is active. GSR defaults to active-High but can be inverted by adding an inverter in front of the GSR input of the appropriate `STARTUP_architecture` symbol.

Logic Table

Inputs			Output
E	D	C	O
0	X	X	Z
1	Dn	↑	Dn

Design Entry Method

This design element is only for use in schematics.

For More Information

- See the [Spartan-3 Generation FPGA User Guide \(UG331\)](#).
- See the [Spartan-3E FPGA Family Data Sheet \(DS312\)](#).

OFDE_1

Macro: D Flip-Flop with Active-High Enable Output Buffer and Inverted Clock

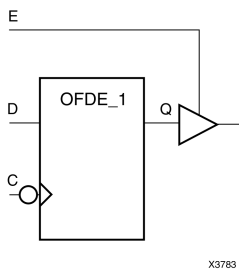

Introduction

This design element and its output buffer are located in an input/output block (IOB). The data output of the flip-flop (Q) is connected to the input of an output buffer or OBUFE. The output of the OBUFE is connected to an OPAD or an IOPAD. The data on the data input (D) is loaded into the flip-flop on the High-to-Low clock (C) transition. When the active-High enable input (E) is High, the data on the flip-flop output (Q) appears on the (O) output. When (E) is Low, the output is high impedance (Z state or Off).

This flip-flop is asynchronously cleared, outputs Low, when power is applied. For FPGA devices, power-on conditions are simulated when global set/reset (GSR) is active. GSR defaults to active-High but can be inverted by adding an inverter in front of the GSR input of the appropriate `STARTUP_architecture` symbol.

Logic Table

Inputs			Outputs
E	D	C	O
0	X	X	Z
1	D	↓	D

Design Entry Method

This design element is only for use in schematics.

For More Information

- See the [Spartan-3 Generation FPGA User Guide \(UG331\)](#).
- See the [Spartan-3E FPGA Family Data Sheet \(DS312\)](#).

OFDE16

Macro: 16-Bit D Flip-Flop with Active-High Enable Output Buffers

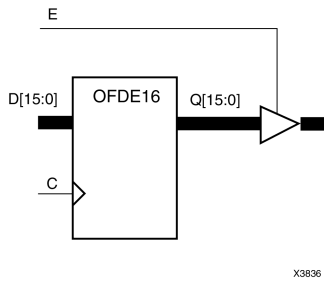

Introduction

This is a multiple D flip-flop whose outputs are enabled by 3-state buffers. The flip-flop data outputs (Q) are connected to the inputs of output buffers (OBUFE). The OBUFE outputs (O) are connected to OPADs or IOPADs. The data on the data inputs (D) is loaded into the flip-flops during the Low-to-High clock (C) transition. When the active-High enable inputs (E) are High, the data on the flip-flop outputs (Q) appears on the OBUFE outputs (O). When (E) is Low, outputs are high impedance (Z state or Off).

This flip-flop is asynchronously cleared, outputs Low, when power is applied. For FPGA devices, power-on conditions are simulated when global set/reset (GSR) is active. GSR defaults to active-High but can be inverted by adding an inverter in front of the GSR input of the appropriate *STARTUP_architecture* symbol.

Logic Table

Inputs			Outputs
E	D	C	O
0	X	X	Z
1	Dn	↑	Dn

Design Entry Method

This design element is only for use in schematics.

For More Information

- See the [Spartan-3 Generation FPGA User Guide \(UG331\)](#).
- See the [Spartan-3E FPGA Family Data Sheet \(DS312\)](#).

OFDE4

Macro: 4-Bit D Flip-Flop with Active-High Enable Output Buffers

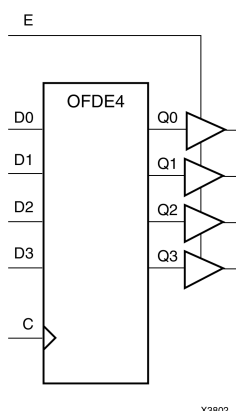

Introduction

This is a multiple D flip-flop whose outputs are enabled by 3-state buffers. The flip-flop data outputs (Q) are connected to the inputs of output buffers (OBUFE). The OBUFE outputs (O) are connected to OPADs or IOPADs. The data on the data inputs (D) is loaded into the flip-flops during the Low-to-High clock (C) transition. When the active-High enable inputs (E) are High, the data on the flip-flop outputs (Q) appears on the OBUFE outputs (O). When (E) is Low, outputs are high impedance (Z state or Off).

This flip-flop is asynchronously cleared, outputs Low, when power is applied. For FPGA devices, power-on conditions are simulated when global set/reset (GSR) is active. GSR defaults to active-High but can be inverted by adding an inverter in front of the GSR input of the appropriate `STARTUP_architecture` symbol.

Logic Table

Inputs			Outputs
E	D	C	O
0	X	X	Z
1	D _n	↑	D _n

Design Entry Method

This design element is only for use in schematics.

For More Information

- See the [Spartan-3 Generation FPGA User Guide \(UG331\)](#).
- See the [Spartan-3E FPGA Family Data Sheet \(DS312\)](#).

OFDE8

Macro: 8-Bit D Flip-Flop with Active-High Enable Output Buffers

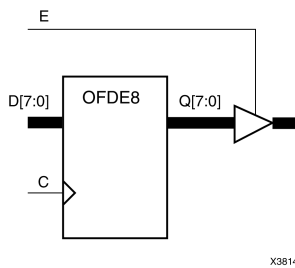

Introduction

This is a multiple D flip-flop whose outputs are enabled by 3-state buffers. The flip-flop data outputs (Q) are connected to the inputs of output buffers (OBUFE). The OBUFE outputs (O) are connected to OPADs or IOPADs. The data on the data inputs (D) is loaded into the flip-flops during the Low-to-High clock (C) transition. When the active-High enable inputs (E) are High, the data on the flip-flop outputs (Q) appears on the OBUFE outputs (O). When (E) is Low, outputs are high impedance (Z state or Off).

This flip-flop is asynchronously cleared, outputs Low, when power is applied. For FPGA devices, power-on conditions are simulated when global set/reset (GSR) is active. GSR defaults to active-High but can be inverted by adding an inverter in front of the GSR input of the appropriate *STARTUP_architecture* symbol.

Logic Table

Inputs			Outputs
E	D	C	O
0	X	X	Z
1	Dn	↑	Dn

Design Entry Method

This design element is only for use in schematics.

For More Information

- See the [Spartan-3 Generation FPGA User Guide \(UG331\)](#).
- See the [Spartan-3E FPGA Family Data Sheet \(DS312\)](#).

OFDI

Macro: Output D Flip-Flop (Asynchronous Preset)

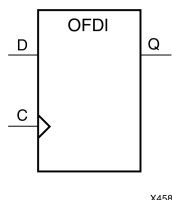

Introduction

The design element is contained in an input/output block (IOB). The output (Q) of the (D) flip-flop is connected to an OPAD or an IOPAD. The data on the (D) input is loaded into the flip-flop during the Low-to-High clock (C) transition and appears at the output (Q).

This flip-flop is asynchronously preset, output High, when power is applied. For FPGA devices, power-on conditions are simulated when global set/reset (GSR) is active. GSR defaults to active-High but can be inverted by adding an inverter in front of the GSR input of the appropriate `STARTUP_architecture` symbol.

Logic Table

Inputs		Outputs
D	C	Q
D	↑	D

Design Entry Method

This design element is only for use in schematics.

For More Information

- See the [Spartan-3 Generation FPGA User Guide \(UG331\)](#).
- See the [Spartan-3E FPGA Family Data Sheet \(DS312\)](#).

OFDI_1

Macro: Output D Flip-Flop with Inverted Clock (Asynchronous Preset)

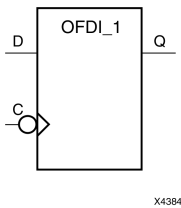

Introduction

This design element exists in an input/output block (IOB). The (D) flip-flop output (Q) is connected to an OPAD or an IOPAD. The data on the (D) input is loaded into the flip-flop during the High-to-Low clock (C) transition and appears on the (Q) output.

This flip-flop is asynchronously preset, output High, when power is applied. For FPGA devices, power-on conditions are simulated when global set/reset (GSR) is active. GSR defaults to active-High but can be inverted by adding an inverter in front of the GSR input of the appropriate `STARTUP_architecture` symbol.

Logic Table

Inputs		Outputs
D	C	Q
D	↓	D

Design Entry Method

This design element is only for use in schematics.

For More Information

- See the [Spartan-3 Generation FPGA User Guide \(UG331\)](#).
- See the [Spartan-3E FPGA Family Data Sheet \(DS312\)](#).

OFDT

Macro: D Flip-Flop with Active-Low 3-State Output Buffer

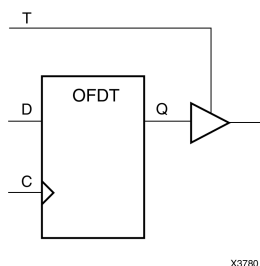

Introduction

This design element is a single D flip-flops whose output is enabled by a 3-state buffer.

The data outputs (Q) of the flip-flops are connected to the inputs of output buffers (OBUFT). The outputs of the OBUFTs (O) are connected to OPADs or IOPADs. The data on the data inputs (D) is loaded into the flip-flops during the Low-to-High clock (C) transition. When the active-Low enable inputs (T) are Low, the data on the flip-flop outputs (Q) appears on the (O) outputs. When (T) is High, outputs are high impedance (Off).

This flip-flop is asynchronously cleared, outputs Low, when power is applied. For FPGA devices, power-on conditions are simulated when global set/reset (GSR) is active. GSR defaults to active-High but can be inverted by adding an inverter in front of the GSR input of the appropriate `STARTUP_architecture` symbol.

Logic Table

Inputs			Outputs
T	D	C	O
1	X	X	Z
0	D	↑	D

Design Entry Method

This design element is only for use in schematics.

For More Information

- See the [Spartan-3 Generation FPGA User Guide \(UG331\)](#).
- See the [Spartan-3E FPGA Family Data Sheet \(DS312\)](#).

OFDT_1

Macro: D Flip-Flop with Active-Low 3-State Output Buffer and Inverted Clock

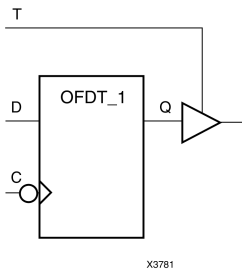

Introduction

The design element and its output buffer are located in an input/output block (IOB). The flip-flop data output (Q) is connected to the input of an output buffer (OBUFT). The OBUFT output is connected to an OPAD or an IOPAD. The data on the data input (D) is loaded into the flip-flop on the High-to-Low clock (C) transition. When the active-Low enable input (T) is Low, the data on the flip-flop output (Q) appears on the (O) output. When (T) is High, the output is high impedance (Off).

This flip-flop is asynchronously cleared, outputs Low, when power is applied. For FPGA devices, power-on conditions are simulated when global set/reset (GSR) is active. GSR defaults to active-High but can be inverted by adding an inverter in front of the GSR input of the appropriate `STARTUP_architecture` symbol.

Logic Table

Inputs			Outputs
T	D	C	O
1	X	X	Z
0	D	↓	D

Design Entry Method

This design element is only for use in schematics.

For More Information

- See the [Spartan-3 Generation FPGA User Guide \(UG331\)](#).
- See the [Spartan-3E FPGA Family Data Sheet \(DS312\)](#).

OFDT16

Macro: 16-Bit D Flip-Flop with Active-Low 3-State Output Buffers

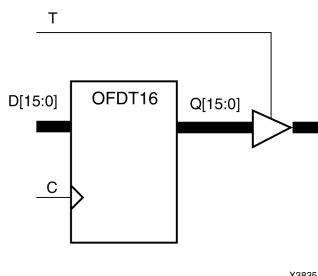

Introduction

This design element is a multiple D flip-flop whose output are enabled by 3-state buffers.

The data outputs (Q) of the flip-flops are connected to the inputs of output buffers (OBUFT). The outputs of the OBUFTs (O) are connected to OPADs or IOPADs. The data on the data inputs (D) is loaded into the flip-flops during the Low-to-High clock (C) transition. When the active-Low enable inputs (T) are Low, the data on the flip-flop outputs (Q) appears on the (O) outputs. When (T) is High, outputs are high impedance (Off).

This flip-flop is asynchronously cleared, outputs Low, when power is applied. For FPGA devices, power-on conditions are simulated when global set/reset (GSR) is active. GSR defaults to active-High but can be inverted by adding an inverter in front of the GSR input of the appropriate *STARTUP_architecture* symbol.

Logic Table

Inputs			Outputs
T	D	C	O
1	X	X	Z
0	D	↑	D

Design Entry Method

This design element is only for use in schematics.

For More Information

- See the [Spartan-3 Generation FPGA User Guide \(UG331\)](#).
- See the [Spartan-3E FPGA Family Data Sheet \(DS312\)](#).

OFDT4

Macro: 4-Bit D Flip-Flop with Active-Low 3-State Output Buffers

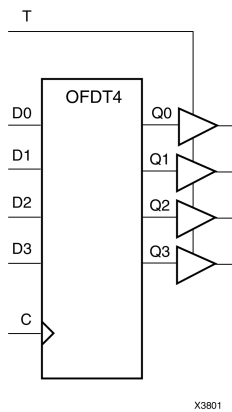

Introduction

This design element is a multiple D flip-flop whose output are enabled by 3-state buffers.

The data outputs (Q) of the flip-flops are connected to the inputs of output buffers (OBUFT). The outputs of the OBUFTs (O) are connected to OPADs or IOPADs. The data on the data inputs (D) is loaded into the flip-flops during the Low-to-High clock (C) transition. When the active-Low enable inputs (T) are Low, the data on the flip-flop outputs (Q) appears on the (O) outputs. When (T) is High, outputs are high impedance (Off).

This flip-flop is asynchronously cleared, outputs Low, when power is applied. For FPGA devices, power-on conditions are simulated when global set/reset (GSR) is active. GSR defaults to active-High but can be inverted by adding an inverter in front of the GSR input of the appropriate `STARTUP_architecture` symbol.

Logic Table

Inputs			Outputs
T	D	C	O
1	X	X	Z
0	D	↑	D

Design Entry Method

This design element is only for use in schematics.

For More Information

- See the [Spartan-3 Generation FPGA User Guide \(UG331\)](#).
- See the [Spartan-3E FPGA Family Data Sheet \(DS312\)](#).

OFDT8

Macro: 8-Bit D Flip-Flop with Active-Low 3-State Output Buffers

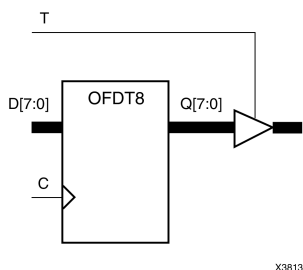

Introduction

This design element is a multiple D flip-flop whose output are enabled by 3-state buffers.

The data outputs (Q) of the flip-flops are connected to the inputs of output buffers (OBUFT). The outputs of the OBUFTs (O) are connected to OPADs or IOPADs. The data on the data inputs (D) is loaded into the flip-flops during the Low-to-High clock (C) transition. When the active-Low enable inputs (T) are Low, the data on the flip-flop outputs (Q) appears on the (O) outputs. When (T) is High, outputs are high impedance (Off).

This flip-flop is asynchronously cleared, outputs Low, when power is applied. For FPGA devices, power-on conditions are simulated when global set/reset (GSR) is active. GSR defaults to active-High but can be inverted by adding an inverter in front of the GSR input of the appropriate `STARTUP_architecture` symbol.

Logic Table

Inputs			Outputs
T	D	C	O
1	X	X	Z
0	D	↑	D

Design Entry Method

This design element is only for use in schematics.

For More Information

- See the [Spartan-3 Generation FPGA User Guide \(UG331\)](#).
- See the [Spartan-3E FPGA Family Data Sheet \(DS312\)](#).

OFDX

Macro: Output D Flip-Flop with Clock Enable

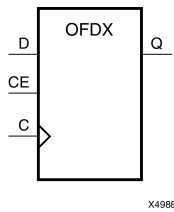

Introduction

This design element is a single output D flip-flop. The (Q) output is connected to OPAD or IOPAD. The data on the (D) input is loaded into the flip-flop during the Low-to-High clock (C) transition and appears on the (Q) output. When (CE) is Low, the flip-flop output does not change.

This flip-flop is asynchronously cleared, outputs Low, when power is applied. For FPGA devices, power-on conditions are simulated when global set/reset (GSR) is active. GSR defaults to active-High but can be inverted by adding an inverter in front of the GSR input of the appropriate *STARTUP_architecture* symbol.

Logic Table

Inputs			Outputs
CE	D	C	Q
1	Dn	↑	Dn
0	X	X	No change

Design Entry Method

This design element is only for use in schematics.

For More Information

- See the [Spartan-3 Generation FPGA User Guide \(UG331\)](#).
- See the [Spartan-3E FPGA Family Data Sheet \(DS312\)](#).

OFDX_1

Macro: Output D Flip-Flop with Inverted Clock and Clock Enable

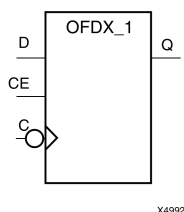

Introduction

The design element is located in an input/output block (IOB). The output (Q) of the (D) flip-flop is connected to an OPAD or an IOPAD. The data on the (D) input is loaded into the flip-flop during the High-to-Low clock (C) transition and appears on the (Q) output. When the (CE) pin is Low, the output (Q) does not change.

This flip-flop is asynchronously cleared, outputs Low, when power is applied. For FPGA devices, power-on conditions are simulated when global set/reset (GSR) is active. GSR defaults to active-High but can be inverted by adding an inverter in front of the GSR input of the appropriate *STARTUP_architecture* symbol.

Logic Table

Inputs			Outputs
CE	D	C	Q
1	D	↓	D
0	X	X	No Change

Design Entry Method

This design element is only for use in schematics.

For More Information

- See the [Spartan-3 Generation FPGA User Guide \(UG331\)](#).
- See the [Spartan-3E FPGA Family Data Sheet \(DS312\)](#).

OFDX16

Macro: 16-Bit Output D Flip-Flop with Clock Enable

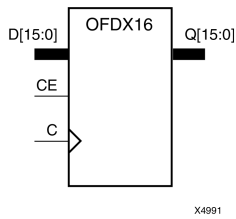

Introduction

This design element is a multiple output D flip-flop. The (Q) output is connected to OPAD or IOPAD. The data on the (D) input is loaded into the flip-flop during the Low-to-High clock (C) transition and appears on the (Q) output. When (CE) is Low, the flip-flop output does not change.

This flip-flop is asynchronously cleared, outputs Low, when power is applied. For FPGA devices, power-on conditions are simulated when global set/reset (GSR) is active. GSR defaults to active-High but can be inverted by adding an inverter in front of the GSR input of the appropriate `STARTUP_architecture` symbol.

Logic Table

Inputs			Outputs
CE	D	C	Q
1	Dn	↑	Dn
0	X	X	No change

Design Entry Method

This design element is only for use in schematics.

For More Information

- See the [Spartan-3 Generation FPGA User Guide \(UG331\)](#).
- See the [Spartan-3E FPGA Family Data Sheet \(DS312\)](#).

OFDX4

Macro: 4-Bit Output D Flip-Flop with Clock Enable

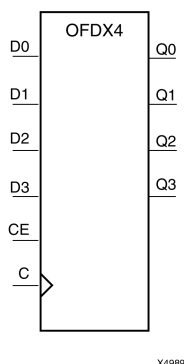

Introduction

This design element is a multiple output D flip-flop. The (Q) output is connected to OPAD or IOPAD. The data on the (D) input is loaded into the flip-flop during the Low-to-High clock (C) transition and appears on the (Q) output. When (CE) is Low, the flip-flop output does not change.

This flip-flop is asynchronously cleared, outputs Low, when power is applied. For FPGA devices, power-on conditions are simulated when global set/reset (GSR) is active. GSR defaults to active-High but can be inverted by adding an inverter in front of the GSR input of the appropriate `STARTUP_architecture` symbol.

Logic Table

Inputs			Outputs
CE	D	C	Q
1	Dn	↑	Dn
0	X	X	No change

Design Entry Method

This design element is only for use in schematics.

For More Information

- See the [Spartan-3 Generation FPGA User Guide \(UG331\)](#).
- See the [Spartan-3E FPGA Family Data Sheet \(DS312\)](#).

OFDX8

Macro: 8-Bit Output D Flip-Flop with Clock Enable

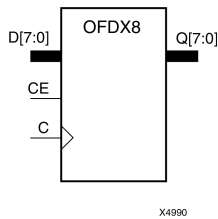

Introduction

This design element is a multiple output D flip-flop. The (Q) output is connected to OPAD or IOPAD. The data on the (D) input is loaded into the flip-flop during the Low-to-High clock (C) transition and appears on the (Q) output. When (CE) is Low, the flip-flop output does not change.

This flip-flop is asynchronously cleared, outputs Low, when power is applied. For FPGA devices, power-on conditions are simulated when global set/reset (GSR) is active. GSR defaults to active-High but can be inverted by adding an inverter in front of the GSR input of the appropriate `STARTUP_architecture` symbol.

Logic Table

Inputs			Outputs
CE	D	C	Q
1	Dn	↑	Dn
0	X	X	No change

Design Entry Method

This design element is only for use in schematics.

For More Information

- See the [Spartan-3 Generation FPGA User Guide \(UG331\)](#).
- See the [Spartan-3E FPGA Family Data Sheet \(DS312\)](#).

OFDXI

Macro: Output D Flip-Flop with Clock Enable (Asynchronous Preset)

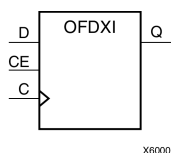

Introduction

The design element is contained in an input/output block (IOB). The output (Q) of the D flip-flop is connected to an OPAD or an IOPAD. The data on the (D) input is loaded into the flip-flop during the Low-to-High clock (C) transition and appears at the output (Q). When (CE) is Low, the output does not change.

This flip-flop is asynchronously preset, output High, when power is applied. For FPGA devices, power-on conditions are simulated when global set/reset (GSR) is active. GSR defaults to active-High but can be inverted by adding an inverter in front of the GSR input of the appropriate `STARTUP_architecture` symbol.

Logic Table

Inputs			Outputs
CE	D	C	Q
1	D	↑	D
0	X	X	No Change

Design Entry Method

This design element is only for use in schematics.

For More Information

- See the [Spartan-3 Generation FPGA User Guide \(UG331\)](#).
- See the [Spartan-3E FPGA Family Data Sheet \(DS312\)](#).

OFDXI_1

Macro: Output D Flip-Flop with Inverted Clock and Clock Enable (Asynchronous Preset)

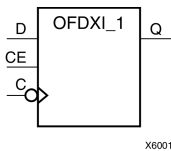

Introduction

The design element is located in an input/output block (IOB). The D flip-flop output (Q) is connected to an OPAD or an IOPAD. The data on the D input is loaded into the flip-flop during the High-to-Low clock (C) transition and appears on the Q output. When CE is Low, the output (Q) does not change.

This flip-flop is asynchronously preset, output High, when power is applied. For FPGA devices, power-on conditions are simulated when global set/reset (GSR) is active. GSR defaults to active-High but can be inverted by adding an inverter in front of the GSR input of the appropriate *STARTUP_architecture* symbol.

Logic Table

Inputs			Outputs
CE	D	C	Q
1	D	↓	D
0	X	X	No Change

Design Entry Method

This design element is only for use in schematics.

For More Information

- See the [Spartan-3 Generation FPGA User Guide \(UG331\)](#).
- See the [Spartan-3E FPGA Family Data Sheet \(DS312\)](#).

OR12

Macro: 12-Input OR Gate with Non-Inverted Inputs

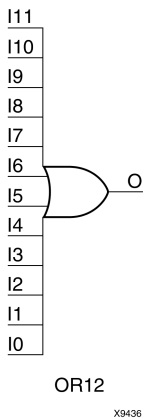

Introduction

OR elements implement logical disjunction. A High output (1) results if one or more inputs are HIGH (1). A LOW output (0) results only if all inputs are Low (0).

OR functions of up to five inputs are available in any combination of inverting and non-inverting inputs. OR functions of six to nine inputs, 12 inputs, and 16 inputs are available with only non-inverting inputs. To invert some or all inputs, use external inverters. Because each input uses a CLB resource, replace functions with unused inputs with functions having the necessary number of inputs.

Logic Table

Input	Output
I0 ... Iz	O
Any input is 1	1
All inputs are 0	0

Design Entry Method

This design element is only for use in schematics.

For More Information

- See the [Spartan-3 Generation FPGA User Guide \(UG331\)](#).
- See the [Spartan-3E FPGA Family Data Sheet \(DS312\)](#).

OR16

Macro: 16-Input OR Gate with Non-Inverted Inputs

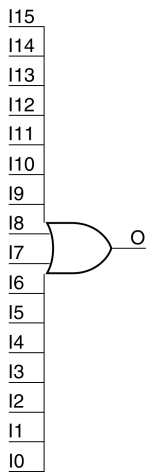

OR16

X9437

Introduction

OR elements implement logical disjunction. A High output (1) results if one or more inputs are HIGH (1). A LOW output (0) results only if all inputs are Low (0).

OR functions of up to five inputs are available in any combination of inverting and non-inverting inputs. OR functions of six to nine inputs, 12 inputs, and 16 inputs are available with only non-inverting inputs. To invert some or all inputs, use external inverters. Because each input uses a CLB resource, replace functions with unused inputs with functions having the necessary number of inputs.

Logic Table

Input	Output
I0 ... Iz	O
Any input is 1	1
All inputs are 0	0

Design Entry Method

This design element is only for use in schematics.

For More Information

- See the [Spartan-3 Generation FPGA User Guide \(UG331\)](#).
- See the [Spartan-3E FPGA Family Data Sheet \(DS312\)](#).

OR2

Primitive: 2-Input OR Gate with Non-Inverted Inputs

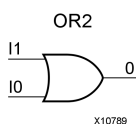

Introduction

OR elements implement logical disjunction. A High output (1) results if one or more inputs are HIGH (1). A LOW output (0) results only if all inputs are Low (0).

OR functions of up to five inputs are available in any combination of inverting and non-inverting inputs. OR functions of six to nine inputs, 12 inputs, and 16 inputs are available with only non-inverting inputs. To invert some or all inputs, use external inverters. Because each input uses a CLB resource, replace functions with unused inputs with functions having the necessary number of inputs.

Logic Table

Input	Output
I0 ... Iz	0
Any input is 1	1
All inputs are 0	0

Design Entry Method

This design element is only for use in schematics.

For More Information

- See the [Spartan-3 Generation FPGA User Guide \(UG331\)](#).
- See the [Spartan-3E FPGA Family Data Sheet \(DS312\)](#).

OR2B1

Primitive: 2-Input OR Gate with 1 Inverted and 1 Non-Inverted Inputs

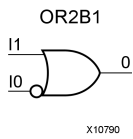

Introduction

OR elements implement logical disjunction. A High output (1) results if one or more inputs are HIGH (1). A LOW output (0) results only if all inputs are Low (0).

OR functions of up to five inputs are available in any combination of inverting and non-inverting inputs. OR functions of six to nine inputs, 12 inputs, and 16 inputs are available with only non-inverting inputs. To invert some or all inputs, use external inverters. Because each input uses a CLB resource, replace functions with unused inputs with functions having the necessary number of inputs.

Design Entry Method

This design element is only for use in schematics.

For More Information

- See the [Spartan-3 Generation FPGA User Guide \(UG331\)](#).
- See the [Spartan-3E FPGA Family Data Sheet \(DS312\)](#).

OR2B2

Primitive: 2-Input OR Gate with Inverted Inputs

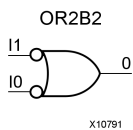

Introduction

OR elements implement logical disjunction. A High output (1) results if one or more inputs are HIGH (1). A LOW output (0) results only if all inputs are Low (0).

OR functions of up to five inputs are available in any combination of inverting and non-inverting inputs. OR functions of six to nine inputs, 12 inputs, and 16 inputs are available with only non-inverting inputs. To invert some or all inputs, use external inverters. Because each input uses a CLB resource, replace functions with unused inputs with functions having the necessary number of inputs.

Design Entry Method

This design element is only for use in schematics.

For More Information

- See the [Spartan-3 Generation FPGA User Guide \(UG331\)](#).
- See the [Spartan-3E FPGA Family Data Sheet \(DS312\)](#).

OR3

Primitive: 3-Input OR Gate with Non-Inverted Inputs

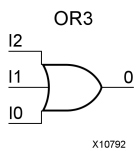

Introduction

OR elements implement logical disjunction. A High output (1) results if one or more inputs are HIGH (1). A LOW output (0) results only if all inputs are Low (0).

OR functions of up to five inputs are available in any combination of inverting and non-inverting inputs. OR functions of six to nine inputs, 12 inputs, and 16 inputs are available with only non-inverting inputs. To invert some or all inputs, use external inverters. Because each input uses a CLB resource, replace functions with unused inputs with functions having the necessary number of inputs.

Logic Table

Input	Output
I0 ... Iz	0
Any input is 1	1
All inputs are 0	0

Design Entry Method

This design element is only for use in schematics.

For More Information

- See the [Spartan-3 Generation FPGA User Guide \(UG331\)](#).
- See the [Spartan-3E FPGA Family Data Sheet \(DS312\)](#).

OR3B1

Primitive: 3-Input OR Gate with 1 Inverted and 2 Non-Inverted Inputs

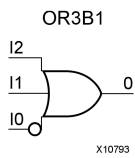

Introduction

OR elements implement logical disjunction. A High output (1) results if one or more inputs are HIGH (1). A LOW output (0) results only if all inputs are Low (0).

OR functions of up to five inputs are available in any combination of inverting and non-inverting inputs. OR functions of six to nine inputs, 12 inputs, and 16 inputs are available with only non-inverting inputs. To invert some or all inputs, use external inverters. Because each input uses a CLB resource, replace functions with unused inputs with functions having the necessary number of inputs.

Design Entry Method

This design element is only for use in schematics.

For More Information

- See the [Spartan-3 Generation FPGA User Guide \(UG331\)](#).
- See the [Spartan-3E FPGA Family Data Sheet \(DS312\)](#).

OR3B2

Primitive: 3-Input OR Gate with 2 Inverted and 1 Non-Inverted Inputs

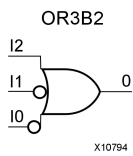

Introduction

OR elements implement logical disjunction. A High output (1) results if one or more inputs are HIGH (1). A LOW output (0) results only if all inputs are Low (0).

OR functions of up to five inputs are available in any combination of inverting and non-inverting inputs. OR functions of six to nine inputs, 12 inputs, and 16 inputs are available with only non-inverting inputs. To invert some or all inputs, use external inverters. Because each input uses a CLB resource, replace functions with unused inputs with functions having the necessary number of inputs.

Design Entry Method

This design element is only for use in schematics.

For More Information

- See the [Spartan-3 Generation FPGA User Guide \(UG331\)](#).
- See the [Spartan-3E FPGA Family Data Sheet \(DS312\)](#).

OR3B3

Primitive: 3-Input OR Gate with Inverted Inputs

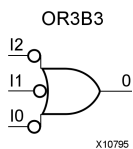

Introduction

OR elements implement logical disjunction. A High output (1) results if one or more inputs are HIGH (1). A LOW output (0) results only if all inputs are Low (0).

OR functions of up to five inputs are available in any combination of inverting and non-inverting inputs. OR functions of six to nine inputs, 12 inputs, and 16 inputs are available with only non-inverting inputs. To invert some or all inputs, use external inverters. Because each input uses a CLB resource, replace functions with unused inputs with functions having the necessary number of inputs.

Design Entry Method

This design element is only for use in schematics.

For More Information

- See the [Spartan-3 Generation FPGA User Guide \(UG331\)](#).
- See the [Spartan-3E FPGA Family Data Sheet \(DS312\)](#).

OR4

Primitive: 4-Input OR Gate with Non-Inverted Inputs

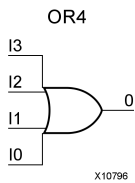

Introduction

OR elements implement logical disjunction. A High output (1) results if one or more inputs are HIGH (1). A LOW output (0) results only if all inputs are Low (0).

OR functions of up to five inputs are available in any combination of inverting and non-inverting inputs. OR functions of six to nine inputs, 12 inputs, and 16 inputs are available with only non-inverting inputs. To invert some or all inputs, use external inverters. Because each input uses a CLB resource, replace functions with unused inputs with functions having the necessary number of inputs.

Logic Table

Input	Output
I0 ... Iz	0
Any input is 1	1
All inputs are 0	0

Design Entry Method

This design element is only for use in schematics.

For More Information

- See the [Spartan-3 Generation FPGA User Guide \(UG331\)](#).
- See the [Spartan-3E FPGA Family Data Sheet \(DS312\)](#).

OR4B1

Primitive: 4-Input OR Gate with 1 Inverted and 3 Non-Inverted Inputs

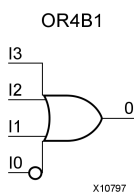

Introduction

OR elements implement logical disjunction. A High output (1) results if one or more inputs are HIGH (1). A LOW output (0) results only if all inputs are Low (0).

OR functions of up to five inputs are available in any combination of inverting and non-inverting inputs. OR functions of six to nine inputs, 12 inputs, and 16 inputs are available with only non-inverting inputs. To invert some or all inputs, use external inverters. Because each input uses a CLB resource, replace functions with unused inputs with functions having the necessary number of inputs.

Design Entry Method

This design element is only for use in schematics.

For More Information

- See the [Spartan-3 Generation FPGA User Guide \(UG331\)](#).
- See the [Spartan-3E FPGA Family Data Sheet \(DS312\)](#).

OR4B2

Primitive: 4-Input OR Gate with 2 Inverted and 2 Non-Inverted Inputs

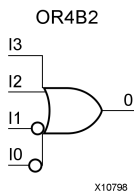

Introduction

OR elements implement logical disjunction. A High output (1) results if one or more inputs are HIGH (1). A LOW output (0) results only if all inputs are Low (0).

OR functions of up to five inputs are available in any combination of inverting and non-inverting inputs. OR functions of six to nine inputs, 12 inputs, and 16 inputs are available with only non-inverting inputs. To invert some or all inputs, use external inverters. Because each input uses a CLB resource, replace functions with unused inputs with functions having the necessary number of inputs.

Design Entry Method

This design element is only for use in schematics.

For More Information

- See the [Spartan-3 Generation FPGA User Guide \(UG331\)](#).
- See the [Spartan-3E FPGA Family Data Sheet \(DS312\)](#).

OR4B3

Primitive: 4-Input OR Gate with 3 Inverted and 1 Non-Inverted Inputs

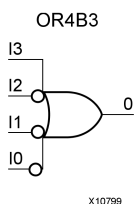

Introduction

OR elements implement logical disjunction. A High output (1) results if one or more inputs are HIGH (1). A LOW output (0) results only if all inputs are Low (0).

OR functions of up to five inputs are available in any combination of inverting and non-inverting inputs. OR functions of six to nine inputs, 12 inputs, and 16 inputs are available with only non-inverting inputs. To invert some or all inputs, use external inverters. Because each input uses a CLB resource, replace functions with unused inputs with functions having the necessary number of inputs.

Design Entry Method

This design element is only for use in schematics.

For More Information

- See the [Spartan-3 Generation FPGA User Guide \(UG331\)](#).
- See the [Spartan-3E FPGA Family Data Sheet \(DS312\)](#).

OR4B4

Primitive: 4-Input OR Gate with Inverted Inputs

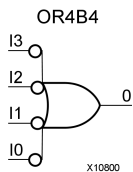

Introduction

OR elements implement logical disjunction. A High output (1) results if one or more inputs are HIGH (1). A LOW output (0) results only if all inputs are Low (0).

OR functions of up to five inputs are available in any combination of inverting and non-inverting inputs. OR functions of six to nine inputs, 12 inputs, and 16 inputs are available with only non-inverting inputs. To invert some or all inputs, use external inverters. Because each input uses a CLB resource, replace functions with unused inputs with functions having the necessary number of inputs.

Design Entry Method

This design element is only for use in schematics.

For More Information

- See the [Spartan-3 Generation FPGA User Guide \(UG331\)](#).
- See the [Spartan-3E FPGA Family Data Sheet \(DS312\)](#).

OR5

Primitive: 5-Input OR Gate with Non-Inverted Inputs

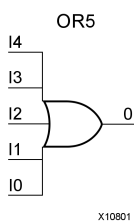

Introduction

OR elements implement logical disjunction. A High output (1) results if one or more inputs are HIGH (1). A LOW output (0) results only if all inputs are Low (0).

OR functions of up to five inputs are available in any combination of inverting and non-inverting inputs. OR functions of six to nine inputs, 12 inputs, and 16 inputs are available with only non-inverting inputs. To invert some or all inputs, use external inverters. Because each input uses a CLB resource, replace functions with unused inputs with functions having the necessary number of inputs.

Logic Table

Input	Output
I0 ... Iz	0
Any input is 1	1
All inputs are 0	0

Design Entry Method

This design element is only for use in schematics.

For More Information

- See the [Spartan-3 Generation FPGA User Guide \(UG331\)](#).
- See the [Spartan-3E FPGA Family Data Sheet \(DS312\)](#).

OR5B1

Primitive: 5-Input OR Gate with 1 Inverted and 4 Non-Inverted Inputs

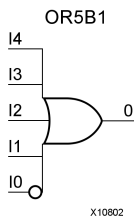

Introduction

OR elements implement logical disjunction. A High output (1) results if one or more inputs are HIGH (1). A LOW output (0) results only if all inputs are Low (0).

OR functions of up to five inputs are available in any combination of inverting and non-inverting inputs. OR functions of six to nine inputs, 12 inputs, and 16 inputs are available with only non-inverting inputs. To invert some or all inputs, use external inverters. Because each input uses a CLB resource, replace functions with unused inputs with functions having the necessary number of inputs.

Design Entry Method

This design element is only for use in schematics.

For More Information

- See the [Spartan-3 Generation FPGA User Guide \(UG331\)](#).
- See the [Spartan-3E FPGA Family Data Sheet \(DS312\)](#).

OR5B2

Primitive: 5-Input OR Gate with 2 Inverted and 3 Non-Inverted Inputs

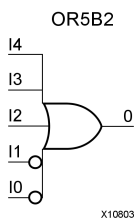

Introduction

OR elements implement logical disjunction. A High output (1) results if one or more inputs are HIGH (1). A LOW output (0) results only if all inputs are Low (0).

OR functions of up to five inputs are available in any combination of inverting and non-inverting inputs. OR functions of six to nine inputs, 12 inputs, and 16 inputs are available with only non-inverting inputs. To invert some or all inputs, use external inverters. Because each input uses a CLB resource, replace functions with unused inputs with functions having the necessary number of inputs.

Design Entry Method

This design element is only for use in schematics.

For More Information

- See the [Spartan-3 Generation FPGA User Guide \(UG331\)](#).
- See the [Spartan-3E FPGA Family Data Sheet \(DS312\)](#).

OR5B3

Primitive: 5-Input OR Gate with 3 Inverted and 2 Non-Inverted Inputs

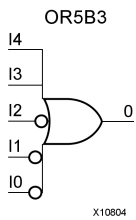

Introduction

OR elements implement logical disjunction. A High output (1) results if one or more inputs are HIGH (1). A LOW output (0) results only if all inputs are Low (0).

OR functions of up to five inputs are available in any combination of inverting and non-inverting inputs. OR functions of six to nine inputs, 12 inputs, and 16 inputs are available with only non-inverting inputs. To invert some or all inputs, use external inverters. Because each input uses a CLB resource, replace functions with unused inputs with functions having the necessary number of inputs.

Design Entry Method

This design element is only for use in schematics.

For More Information

- See the [Spartan-3 Generation FPGA User Guide \(UG331\)](#).
- See the [Spartan-3E FPGA Family Data Sheet \(DS312\)](#).

OR5B4

Primitive: 5-Input OR Gate with 4 Inverted and 1 Non-Inverted Inputs

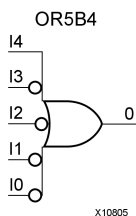

Introduction

OR elements implement logical disjunction. A High output (1) results if one or more inputs are HIGH (1). A LOW output (0) results only if all inputs are Low (0).

OR functions of up to five inputs are available in any combination of inverting and non-inverting inputs. OR functions of six to nine inputs, 12 inputs, and 16 inputs are available with only non-inverting inputs. To invert some or all inputs, use external inverters. Because each input uses a CLB resource, replace functions with unused inputs with functions having the necessary number of inputs.

Design Entry Method

This design element is only for use in schematics.

For More Information

- See the [Spartan-3 Generation FPGA User Guide \(UG331\)](#).
- See the [Spartan-3E FPGA Family Data Sheet \(DS312\)](#).

OR5B5

Primitive: 5-Input OR Gate with Inverted Inputs

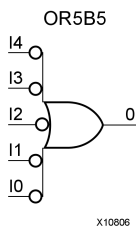

Introduction

OR elements implement logical disjunction. A High output (1) results if one or more inputs are HIGH (1). A LOW output (0) results only if all inputs are Low (0).

OR functions of up to five inputs are available in any combination of inverting and non-inverting inputs. OR functions of six to nine inputs, 12 inputs, and 16 inputs are available with only non-inverting inputs. To invert some or all inputs, use external inverters. Because each input uses a CLB resource, replace functions with unused inputs with functions having the necessary number of inputs.

Design Entry Method

This design element is only for use in schematics.

For More Information

- See the [Spartan-3 Generation FPGA User Guide \(UG331\)](#).
- See the [Spartan-3E FPGA Family Data Sheet \(DS312\)](#).

OR6

Macro: 6-Input OR Gate with Non-Inverted Inputs

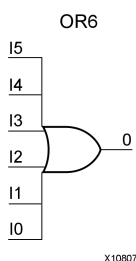

Introduction

OR elements implement logical disjunction. A High output (1) results if one or more inputs are HIGH (1). A LOW output (0) results only if all inputs are Low (0).

OR functions of up to five inputs are available in any combination of inverting and non-inverting inputs. OR functions of six to nine inputs, 12 inputs, and 16 inputs are available with only non-inverting inputs. To invert some or all inputs, use external inverters. Because each input uses a CLB resource, replace functions with unused inputs with functions having the necessary number of inputs.

Logic Table

Input	Output
I0 ... Iz	0
Any input is 1	1
All inputs are 0	0

Design Entry Method

This design element is only for use in schematics.

For More Information

- See the [Spartan-3 Generation FPGA User Guide \(UG331\)](#).
- See the [Spartan-3E FPGA Family Data Sheet \(DS312\)](#).

OR7

Macro: 7-Input OR Gate with Non-Inverted Inputs

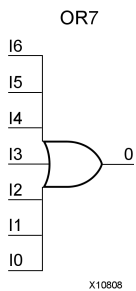

Introduction

OR elements implement logical disjunction. A High output (1) results if one or more inputs are HIGH (1). A LOW output (0) results only if all inputs are Low (0).

OR functions of up to five inputs are available in any combination of inverting and non-inverting inputs. OR functions of six to nine inputs, 12 inputs, and 16 inputs are available with only non-inverting inputs. To invert some or all inputs, use external inverters. Because each input uses a CLB resource, replace functions with unused inputs with functions having the necessary number of inputs.

Logic Table

Input	Output
I0 ... Iz	0
Any input is 1	1
All inputs are 0	0

Design Entry Method

This design element is only for use in schematics.

For More Information

- See the [Spartan-3 Generation FPGA User Guide \(UG331\)](#).
- See the [Spartan-3E FPGA Family Data Sheet \(DS312\)](#).

OR8

Macro: 8-Input OR Gate with Non-Inverted Inputs

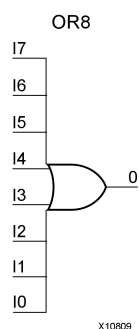

Introduction

OR elements implement logical disjunction. A High output (1) results if one or more inputs are HIGH (1). A LOW output (0) results only if all inputs are Low (0).

OR functions of up to five inputs are available in any combination of inverting and non-inverting inputs. OR functions of six to nine inputs, 12 inputs, and 16 inputs are available with only non-inverting inputs. To invert some or all inputs, use external inverters. Because each input uses a CLB resource, replace functions with unused inputs with functions having the necessary number of inputs.

Logic Table

Input	Output
I0 ... Iz	0
Any input is 1	1
All inputs are 0	0

Design Entry Method

This design element is only for use in schematics.

For More Information

- See the [Spartan-3 Generation FPGA User Guide \(UG331\)](#).
- See the [Spartan-3E FPGA Family Data Sheet \(DS312\)](#).

OR9

Macro: 9-Input OR Gate with Non-Inverted Inputs

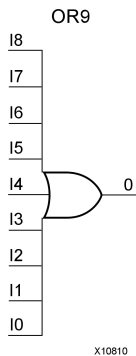

Introduction

OR elements implement logical disjunction. A High output (1) results if one or more inputs are HIGH (1). A LOW output (0) results only if all inputs are Low (0).

OR functions of up to five inputs are available in any combination of inverting and non-inverting inputs. OR functions of six to nine inputs, 12 inputs, and 16 inputs are available with only non-inverting inputs. To invert some or all inputs, use external inverters. Because each input uses a CLB resource, replace functions with unused inputs with functions having the necessary number of inputs.

Logic Table

Input	Output
I0 ... Iz	0
Any input is 1	1
All inputs are 0	0

Design Entry Method

This design element is only for use in schematics.

For More Information

- See the [Spartan-3 Generation FPGA User Guide \(UG331\)](#).
- See the [Spartan-3E FPGA Family Data Sheet \(DS312\)](#).

PULLDOWN

Primitive: Resistor to GND for Input Pads, Open-Drain, and 3-State Outputs

PULLDOWN

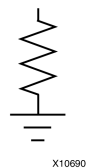

Introduction

This resistor element is connected to input, output, or bidirectional pads to guarantee a logic Low level for nodes that might float.

Port Descriptions

Port	Direction	Width	Function
O	Output	1	Pulldown output (connect directly to top level port)

Design Entry Method

This design element can be used in schematics.

This element can be connected to a net in the following locations on a top-level schematic file:

- A net connected to an input IO Marker.
- A net connected to both an output IO Marker and 3-statable IO element, such as an OBUFT.

For More Information

- See the [Spartan-3 Generation FPGA User Guide \(UG331\)](#).
- See the [Spartan-3E FPGA Family Data Sheet \(DS312\)](#).

PULLUP

Primitive: Resistor to VCC for Input PADs, Open-Drain, and 3-State Outputs

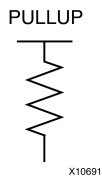

Introduction

This design element allows for an input, 3-state output or bi-directional port to be driven to a weak high value when not being driven by an internal or external source. This element establishes a High logic level for open-drain elements and macros when all the drivers are off.

Port Descriptions

Port	Direction	Width	Function
O	Output	1	Pullup output (connect directly to top level port)

Design Entry Method

This design element can be used in schematics.

This element can be connected to a net in the following locations on a top-level schematic file:

- A net connected to an input IO Marker
- A net connected to both an output IO Marker and 3-statable IO element, such as an OBUFT.

For More Information

- See the [Spartan-3 Generation FPGA User Guide \(UG331\)](#).
- See the [Spartan-3E FPGA Family Data Sheet \(DS312\)](#).

RAM16X1D

Primitive: 16-Deep by 1-Wide Static Dual Port Synchronous RAM

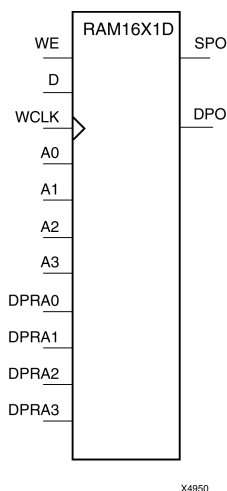

Introduction

This element is a 16-word by 1-bit static dual port random access memory with synchronous write capability. The device has two address ports: the read address (DPRA3:DPRA0) and the write address (A3:A0). These two address ports are asynchronous. The read address controls the location of the data driven out of the output pin (DPO), and the write address controls the destination of a valid write transaction. When the write enable (WE) is Low, transitions on the write clock (WCLK) are ignored and data stored in the RAM is not affected.

When WE is High, any positive transition on (WCLK) loads the data on the data input (D) into the word selected by the 4-bit write address. For predictable performance, write address and data inputs must be stable before a Low-to-High (WCLK) transition. This RAM block assumes an active-High (WCLK). (WCLK) can be active-High or active-Low. Any inverter placed on the (WCLK) input net is absorbed into the block.

The SPO output reflects the data in the memory cell addressed by A3:A0. The DPO output reflects the data in the memory cell addressed by DPRA3:DPRA0.

Note The write process is not affected by the address on the read address port.

You can use the INIT attribute to directly specify an initial value. The value must be a hexadecimal number, for example, INIT=ABAC. If the INIT attribute is not specified, the RAM is initialized with all zeros.

Logic Table

Mode selection is shown in the following logic table:

Inputs			Outputs	
WE (mode)	WCLK	D	SPO	DPO
0 (read)	X	X	data_a	data_d
1 (read)	0	X	data_a	data_d
1 (read)	1	X	data_a	data_d
1 (write)	↑	D	D	data_d
1 (read)	↓	X	data_a	data_d

data_a = word addressed by bits A3-A0
data_d = word addressed by bits DPRA3-DPRA0

Design Entry Method

This design element can be used in schematics.

Available Attributes

Attribute	Data Type	Allowed Values	Default	Description
INIT	Hexadecimal	Any 16-Bit Value	All zeros.	Initializes RAMs, registers, and look-up tables.

For More Information

- See the [Spartan-3 Generation FPGA User Guide \(UG331\)](#).
- See the [Spartan-3E FPGA Family Data Sheet \(DS312\)](#).

RAM16X1D_1

Primitive: 16-Deep by 1-Wide Static Dual Port Synchronous RAM with Negative-Edge Clock

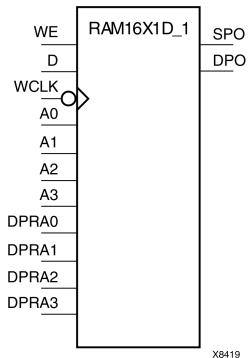

Introduction

This is a 16-word by 1-bit static dual port random access memory with synchronous write capability and negative-edge clock. The device has two separate address ports: the read address (DPRA3:DPRA0) and the write address (A3:A0). These two address ports are asynchronous. The read address controls the location of the data driven out of the output pin (DPO), and the write address controls the destination of a valid write transaction.

When the write enable (WE) is set to Low, transitions on the write clock (WCLK) are ignored and data stored in the RAM is not affected. When (WE) is High, any negative transition on (WCLK) loads the data on the data input (D) into the word selected by the 4-bit write address. For predictable performance, write address and data inputs must be stable before a High-to-Low WCLK transition. This RAM block assumes an active-Low (WCLK). (WCLK) can be active-High or active-Low. Any inverter placed on the (WCLK) input net is absorbed into the block.

You can initialize RAM16X1D_1 during configuration using the INIT attribute.

The SPO output reflects the data in the memory cell addressed by A3:A0. The DPO output reflects the data in the memory cell addressed by DPRA3:DPRA0.

Note The write process is not affected by the address on the read address port.

Logic Table

Mode selection is shown in the following logic table:

Inputs			Outputs	
WE (mode)	WCLK	D	SPO	DPO
0 (read)	X	X	data_a	data_d
1 (read)	0	X	data_a	data_d
1 (read)	1	X	data_a	data_d
1 (write)	↓	D	D	data_d
1 (read)	↑	X	data_a	data_d

data_a = word addressed by bits A3:A0
data_d = word addressed by bits DPRA3:DPRA0

Port Descriptions

Port	Direction	Width	Function
DPO	Output	1	Read-only 1-Bit data output
SPO	Output	1	R/W 1-Bit data output
A0	Input	1	R/W address[0] input
A1	Input	1	R/W address[1] input
A2	Input	1	R/W address[2] input
A3	Input	1	R/W address[3] input
D	Input	1	Write 1-Bit data input
DPRA0	Input	1	Read-only address[0] input
DPRA1	Input	1	Read-only address[1] input
DPRA2	Input	1	Read-only address[2] input
DPRA3	Input	1	Read-only address[3] input
WCLK	Input	1	Write clock input
WE	Input	1	Write enable input

Design Entry Method

This design element can be used in schematics.

Available Attributes

Attribute	Data Type	Allowed Values	Default	Description
INIT	Hexadecimal	Any 16-Bit Value	All zeros	Initializes RAMs, registers, and look-up tables.

For More Information

- See the [Spartan-3 Generation FPGA User Guide \(UG331\)](#).
- See the [Spartan-3E FPGA Family Data Sheet \(DS312\)](#).

RAM16X1S

Primitive: 16-Deep by 1-Wide Static Synchronous RAM

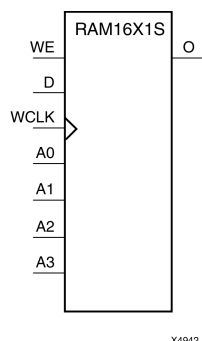

Introduction

This element is a 16-word by 1-bit static random access memory with synchronous write capability. When the write enable (WE) is set Low, transitions on the write clock (WCLK) are ignored and data stored in the RAM is not affected. When WE is set High, any positive transition on WCLK loads the data on the data input (D) into the word selected by the 4-bit address (A3:A0). This RAM block assumes an active-High WCLK. However, WCLK can be active-High or active-Low. Any inverter placed on the WCLK input net is absorbed into the block.

The signal output on the data output pin (O) is the data that is stored in the RAM at the location defined by the values on the address pins. You can initialize RAM16X1S during configuration using the INIT attribute.

Logic Table

Inputs			Outputs
WE(mode)	WCLK	D	O
0 (read)	X	X	Data
1 (read)	0	X	Data
1 (read)	1	X	Data
1 (write)	↑	D	D
1 (read)	↓	X	Data

Data = word addressed by bits A3:A0

Design Entry Method

This design element can be used in schematics.

Available Attributes

Attribute	Data Type	Allowed Values	Default	Description
INIT	Hexadecimal	Any 16-Bit Value	All zeros	Specifies initial contents of the RAM.

For More Information

- See the [Spartan-3 Generation FPGA User Guide \(UG331\)](#).
- See the [Spartan-3E FPGA Family Data Sheet \(DS312\)](#).

RAM16X1S_1

Primitive: 16-Deep by 1-Wide Static Synchronous RAM with Negative-Edge Clock

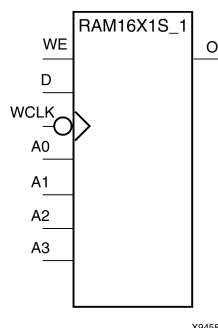

Introduction

This element is a 16-word by 1-bit static random access memory with synchronous write capability and negative-edge clock. When the write enable (WE) is Low, transitions on the write clock (WCLK) are ignored and data stored in the RAM is not affected. When (WE) is High, any negative transition on (WCLK) loads the data on the data input (D) into the word selected by the 4-bit address (A3:A0). For predictable performance, address and data inputs must be stable before a High-to-Low WCLK transition. This RAM block assumes an active-Low (WCLK). However, (WCLK) can be active-High or active-Low. Any inverter placed on the (WCLK) input net is absorbed into the block.

The signal output on the data output pin (O) is the data that is stored in the RAM at the location defined by the values on the address pins.

You can initialize this element during configuration using the INIT attribute.

Logic Table

Inputs			Outputs
WE(mode)	WCLK	D	O
0 (read)	X	X	Data
1 (read)	0	X	Data
1 (read)	1	X	Data
1 (write)	↓	D	D
1 (read)	↑	X	Data

Data = word addressed by bits A3:A0

Design Entry Method

This design element can be used in schematics.

Available Attributes

Attribute	Data Type	Allowed Values	Default	Description
INIT	Hexadecimal	Any 16-Bit Value	All zeros	Specifies initial contents of the RAM.

For More Information

- See the [Spartan-3 Generation FPGA User Guide \(UG331\)](#).
- See the [Spartan-3E FPGA Family Data Sheet \(DS312\)](#).

RAM16X2S

Primitive: 16-Deep by 2-Wide Static Synchronous RAM

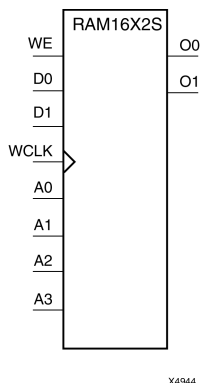

Introduction

This element is a 16-word by 2-bit static random access memory with synchronous write capability. When the write enable (WE) is Low, transitions on the write clock (WCLK) are ignored and data stored in the RAM is not affected. When WE is High, any positive transition on WCLK loads the data on the data input (D1:D0) into the word selected by the 4-bit address (A3:A0). For predictable performance, address and data inputs must be stable before a Low-to-High WCLK transition. This RAM block assumes an active-High WCLK. However, WCLK can be active-High or active-Low. Any inverter placed on the WCLK input net is absorbed into the block.

The signal output on the data output pins (O1:O0) is the data that is stored in the RAM at the location defined by the values on the address pins.

You can use the INIT_xx properties to specify the initial contents of a wide RAM. INIT_00 initializes the RAM cells corresponding to the O0 output, INIT_01 initializes the cells corresponding to the O1 output, etc. For example, a RAM16X2S instance is initialized by INIT_00 and INIT_01 containing 4 hex characters each. A RAM16X8S instance is initialized by eight properties INIT_00 through INIT_07 containing 4 hex characters each. A RAM64x2S instance is completely initialized by two properties INIT_00 and INIT_01 containing 16 hex characters each.

Except for Virtex-4 devices, the initial contents of this element cannot be specified directly.

Logic Table

Inputs			Outputs
WE (mode)	WCLK	D1:D0	O1:O0
0 (read)	X	X	Data
1 (read)	0	X	Data
1 (read)	1	X	Data
1 (write)	↑	D1:D0	D1:D0
1 (read)	↓	X	Data
Data = word addressed by bits A3:A0			

Design Entry Method

This design element can be used in schematics.

Available Attributes

Attribute	Data Type	Allowed Values	Default	Description
INIT_00 to INIT_01	Hexadecimal	Any 16-Bit Value	All zeros	Initializes RAMs, registers, and look-up tables.

For More Information

- See the [Spartan-3 Generation FPGA User Guide \(UG331\)](#).
- See the [Spartan-3E FPGA Family Data Sheet \(DS312\)](#).

RAM16X4S

Primitive: 16-Deep by 4-Wide Static Synchronous RAM

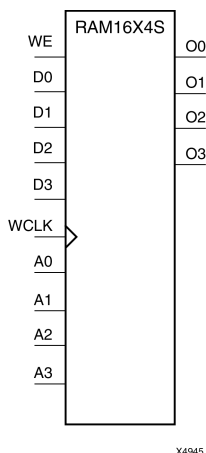

Introduction

This element is a 16-word by 4-bit static random access memory with synchronous write capability. When the write enable (WE) is Low, transitions on the write clock (WCLK) are ignored and data stored in the RAM is not affected. When WE is High, any positive transition on WCLK loads the data on the data input (D3:D0) into the word selected by the 4-bit address (A3:A0). For predictable performance, address and data inputs must be stable before a Low-to-High WCLK transition. This RAM block assumes an active-High WCLK. However, WCLK can be active-High or active-Low. Any inverter placed on the WCLK input net is absorbed into the block.

The signal output on the data output pins (O3:O0) is the data that is stored in the RAM at the location defined by the values on the address pins.

Logic Table

Inputs			Outputs
WE (mode)	WCLK	D3:D0	O3:O0
0 (read)	X	X	Data
1 (read)	0	X	Data
1 (read)	1	X	Data
1 (write)	↑	D3:D0	D3:D0
1 (read)	↓	X	Data

Data = word addressed by bits A3:A0.

Design Entry Method

This design element is only for use in schematics.

Available Attributes

Attribute	Data Type	Allowed Values	Default	Description
INIT_00 to INIT_03	Hexadecimal	Any 16-Bit Value	All zeros	INIT of RAM

For More Information

- See the [Spartan-3 Generation FPGA User Guide \(UG331\)](#).
- See the [Spartan-3E FPGA Family Data Sheet \(DS312\)](#).

RAM16X8S

Primitive: 16-Deep by 8-Wide Static Synchronous RAM

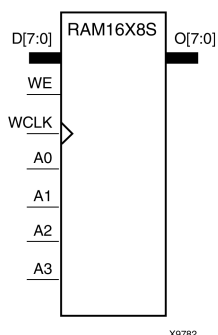

Introduction

This element is a 16-word by 8-bit static random access memory with synchronous write capability. When the write enable (WE) is Low, transitions on the write clock (WCLK) are ignored and data stored in the RAM is not affected. When WE is High, any positive transition on WCLK loads the data on data inputs (D7:D0) into the word selected by the 4-bit address (A3:A0). For predictable performance, address and data inputs must be stable before a Low-to-High WCLK transition. This RAM block assumes an active-High WCLK. However, WCLK can be active-High or active-Low. Any inverter placed on the WCLK input net is absorbed into the block.

The signal output on the data output pins (O7:O0) is the data that is stored in the RAM at the location defined by the values on the address pins.

Logic Table

Inputs			Outputs
WE (mode)	WCLK	D7:D0	O7:O0
0 (read)	X	X	Data
1 (read)	0	X	Data
1 (read)	1	X	Data
1 (write)	↑	D7:D0	D7:D0
1 (read)	↓	X	Data

Data = word addressed by bits A3:A0

Design Entry Method

This design element is only for use in schematics.

Available Attributes

Attribute	Data Type	Allowed Values	Default	Description
INIT_00 to INIT_07	Hexadecimal	Any 16-Bit Value	All zeros	Initializes RAMs, registers, and look-up tables.

For More Information

- See the [Spartan-3 Generation FPGA User Guide \(UG331\)](#).
- See the [Spartan-3E FPGA Family Data Sheet \(DS312\)](#).

RAM32X1S

Primitive: 32-Deep by 1-Wide Static Synchronous RAM

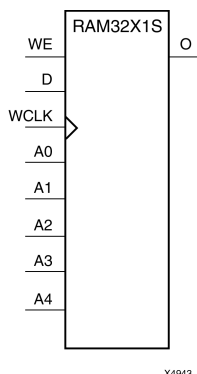

Introduction

The design element is a 32-word by 1-bit static random access memory with synchronous write capability. When the write enable is Low, transitions on the write clock (WCLK) are ignored and data stored in the RAM is not affected. When (WE) is High, any positive transition on (WCLK) loads the data on the data input (D) into the word selected by the 5-bit address (A4-A0). For predictable performance, address and data inputs must be stable before a Low-to-High (WCLK) transition. This RAM block assumes an active-High (WCLK). However, (WCLK) can be active-High or active-Low. Any inverter placed on the (WCLK) input net is absorbed into the block.

The signal output on the data output pin (O) is the data that is stored in the RAM at the location defined by the values on the address pins. You can initialize RAM32X1S during configuration using the INIT attribute.

Logic Table

Inputs			Outputs
WE (Mode)	WCLK	D	O
0 (read)	X	X	Data
1 (read)	0	X	Data
1 (read)	1	X	Data
1 (write)	↑	D	D
1 (read)	↓	X	Data

Design Entry Method

This design element can be used in schematics.

Available Attributes

Attribute	Data Type	Allowed Values	Default	Descriptions
INIT	Hexadecimal	Any 32-Bit Value	All zeros	Specifies initial contents of the RAM.

For More Information

- See the [Spartan-3 Generation FPGA User Guide \(UG331\)](#).
- See the [Spartan-3E FPGA Family Data Sheet \(DS312\)](#).

RAM32X1S_1

Primitive: 32-Deep by 1-Wide Static Synchronous RAM with Negative-Edge Clock

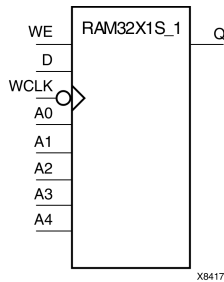

Introduction

The design element is a 32-word by 1-bit static random access memory with synchronous write capability. When the write enable is Low, transitions on the write clock (WCLK) are ignored and data stored in the RAM is not affected. When (WE) is High, any negative transition on (WCLK) loads the data on the data input (D) into the word selected by the 5-bit address (A4:A0). For predictable performance, address and data inputs must be stable before a High-to-Low (WCLK) transition. This RAM block assumes an active-Low (WCLK). However, (WCLK) can be active-High or active-Low. Any inverter placed on the (WCLK) input net is absorbed into the block.

The signal output on the data output pin (O) is the data that is stored in the RAM at the location defined by the values on the address pins. You can initialize RAM32X1S_1 during configuration using the INIT attribute.

Logic Table

Inputs			Outputs
WE (Mode)	WCLK	D	O
0 (read)	X	X	Data
1 (read)	0	X	Data
1 (read)	1	X	Data
1 (write)	↓	D	D
1 (read)	↑	X	Data

Data = word addressed by bits A4:A0

Design Entry Method

This design element can be used in schematics.

Available Attributes

Attribute	Data Type	Allowed Values	Default	Descriptions
INIT	Hexadecimal	Any 32-Bit Value	0	Initializes RAMs, registers, and look-up tables.

For More Information

- See the [Spartan-3 Generation FPGA User Guide \(UG331\)](#).
- See the [Spartan-3E FPGA Family Data Sheet \(DS312\)](#).

RAM32X2S

Primitive: 32-Deep by 2-Wide Static Synchronous RAM

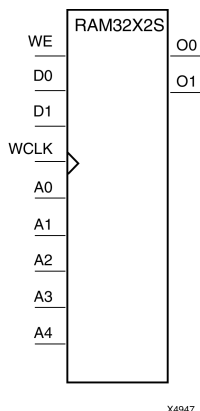

Introduction

The design element is a 32-word by 2-bit static random access memory with synchronous write capability. When the write enable (WE) is Low, transitions on the write clock (WCLK) are ignored and data stored in the RAM is not affected. When (WE) is High, any positive transition on (WCLK) loads the data on the data input (D1-D0) into the word selected by the 5-bit address (A4-A0). For predictable performance, address and data inputs must be stable before a Low-to-High (WCLK) transition. This RAM block assumes an active-High (WCLK). However, (WCLK) can be active-High or active-Low. Any inverter placed on the (WCLK) input net is absorbed into the block. The signal output on the data output pins (O1-O0) is the data that is stored in the RAM at the location defined by the values on the address pins.

You can use the INIT_00 and INIT_01 properties to specify the initial contents of RAM32X2S.

Logic Table

Inputs			Outputs
WE (Mode)	WCLK	D	O0-O1
0 (read)	X	X	Data
1 (read)	0	X	Data
1 (read)	1	X	Data
1 (write)	↑	D1:D0	D1:D0
1 (read)	↓	X	Data

Data = word addressed by bits A4:A0

Design Entry Method

This design element can be used in schematics.

Available Attributes

Attribute	Data Type	Allowed Values	Default	Descriptions
INIT_00	Hexadecimal	Any 32-Bit Value	All zeros	INIT for bit 0 of RAM.
INIT_01	Hexadecimal	Any 32-Bit Value	All zeros	INIT for bit 1 of RAM.

For More Information

- See the [Spartan-3 Generation FPGA User Guide \(UG331\)](#).
- See the [Spartan-3E FPGA Family Data Sheet \(DS312\)](#).

RAM32X4S

Primitive: 32-Deep by 4-Wide Static Synchronous RAM

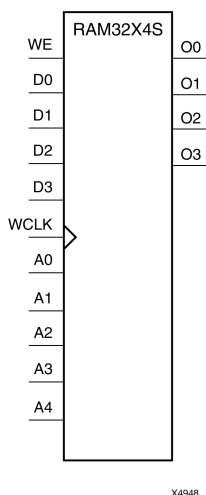

Introduction

This design element is a 32-word by 4-bit static random access memory with synchronous write capability. When the write enable (WE) is Low, transitions on the write clock (WCLK) are ignored and data stored in the RAM is not affected. When WE is High, any positive transition on WCLK loads the data on the data inputs (D3-D0) into the word selected by the 5-bit address (A4:A0). For predictable performance, address and data inputs must be stable before a Low-to-High WCLK transition. This RAM block assumes an active-High WCLK. However, WCLK can be active-High or active-Low. Any inverter placed on the WCLK input net is absorbed into the block.

The signal output on the data output pins (O3-O0) is the data that is stored in the RAM at the location defined by the values on the address pins.

Logic Table

Inputs			Outputs
WE	WCLK	D3-D0	O3-O0
0 (read)	X	X	Data
1 (read)	0	X	Data
1 (read)	1	X	Data
1 (write)	↑	D3:D0	D3:D0
1 (read)	↓	X	Data
Data = word addressed by bits A4:A0			

Design Entry Method

This design element is only for use in schematics.

Available Attributes

Attribute	Data Type	Allowed Values	Default	Description
INIT_00	Hexadecimal	Any 32-Bit Value	All zeros	INIT for bit 0 of RAM.
INIT_01	Hexadecimal	Any 32-Bit Value	All zeros	INIT for bit 1 of RAM.
INIT_02	Hexadecimal	Any 32-Bit Value	All zeros	INIT for bit 2 of RAM.
INIT_03	Hexadecimal	Any 32-Bit Value	All zeros	INIT for bit 3 of RAM.

For More Information

- See the [Spartan-3 Generation FPGA User Guide \(UG331\)](#).
- See the [Spartan-3E FPGA Family Data Sheet \(DS312\)](#).

RAM32X8S

Primitive: 32-Deep by 8-Wide Static Synchronous RAM

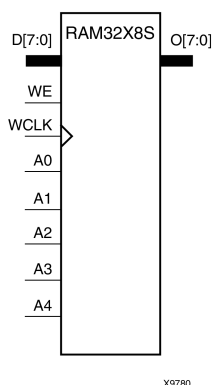

Introduction

This design element is a 32-word by 8-bit static random access memory with synchronous write capability. When the write enable (WE) is Low, transitions on the write clock (WCLK) are ignored and data stored in the RAM is not affected. When WE is High, any positive transition on WCLK loads the data on the data inputs (D7:D0) into the word selected by the 5-bit address (A4:A0). For predictable performance, address and data inputs must be stable before a Low-to-High WCLK transition. This RAM block assumes an active-High WCLK. However, WCLK can be active-High or active-Low. Any inverter placed on the WCLK input net is absorbed into the block.

The signal output on the data output pins (O7:O0) is the data that is stored in the RAM at the location defined by the values on the address pins.

Logic Table

Inputs			Outputs
WE (mode)	WCLK	D7:D0	O7:O0
0 (read)	X	X	Data
1 (read)	0	X	Data
1 (read)	1	X	Data
1 (write)	↑	D7:D0	D7:D0
1 (read)	↓	X	Data
Data = word addressed by bits A4:A0			

Design Entry Method

This design element is only for use in schematics.

Available Attributes

Attribute	Data Type	Allowed Values	Default	Description
INIT_00	Hexadecimal	Any 32-Bit Value	All zeros	INIT for bit 0 of RAM.
INIT_01	Hexadecimal	Any 32-Bit Value	All zeros	INIT for bit 1 of RAM.
INIT_02	Hexadecimal	Any 32-Bit Value	All zeros	INIT for bit 2 of RAM.
INIT_03	Hexadecimal	Any 32-Bit Value	All zeros	INIT for bit 3 of RAM.
INIT_04	Hexadecimal	Any 32-Bit Value	All zeros	INIT for bit 4 of RAM.
INIT_05	Hexadecimal	Any 32-Bit Value	All zeros	INIT for bit 5 of RAM.
INIT_06	Hexadecimal	Any 32-Bit Value	All zeros	INIT for bit 6 of RAM.
INIT_07	Hexadecimal	Any 32-Bit Value	All zeros	INIT for bit 7 of RAM.

For More Information

- See the [Spartan-3 Generation FPGA User Guide \(UG331\)](#).
- See the [Spartan-3E FPGA Family Data Sheet \(DS312\)](#).

RAM64X1S

Primitive: 64-Deep by 1-Wide Static Synchronous RAM

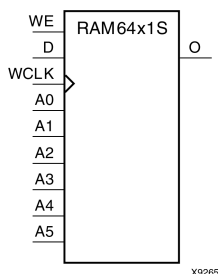

Introduction

This design element is a 64-word by 1-bit static random access memory (RAM) with synchronous write capability. When the write enable is set Low, transitions on the write clock (WCLK) are ignored and data stored in the RAM is not affected. When WE is set High, any positive transition on WCLK loads the data on the data input (D) into the word selected by the 6-bit address (A5:A0). This RAM block assumes an active-High WCLK. However, WCLK can be active-High or active-Low. Any inverter placed on the WCLK input net is absorbed into the block.

The signal output on the data output pin (O) is the data that is stored in the RAM at the location defined by the values on the address pins.

You can initialize this element during configuration using the INIT attribute.

Logic Table

Mode selection is shown in the following logic table

Inputs			Outputs
WE (mode)	WCLK	D	O
0 (read)	X	X	Data
1 (read)	0	X	Data
1 (read)	1	X	Data
1 (write)	↑	D	D
1 (read)	↓	X	Data

Data = word addressed by bits A5:A0

Design Entry Method

This design element can be used in schematics.

Available Attributes

Attribute	Data Type	Allowed Values	Default	Description
INIT	Hexadecimal	Any 64-Bit Value	All zeros	Initializes ROMs, RAMs, registers, and look-up tables.

For More Information

- See the [Spartan-3 Generation FPGA User Guide \(UG331\)](#).
- See the [Spartan-3E FPGA Family Data Sheet \(DS312\)](#).

RAM64X1S_1

Primitive: 64-Deep by 1-Wide Static Synchronous RAM with Negative-Edge Clock

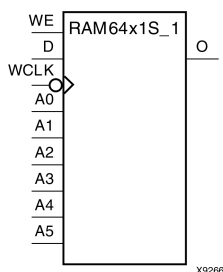

Introduction

This design element is a 64-word by 1-bit static random access memory with synchronous write capability. When the write enable is Low, transitions on the write clock (WCLK) are ignored and data stored in the RAM is not affected. When (WE) is High, any negative transition on (WCLK) loads the data on the data input (D) into the word selected by the 6-bit address (A5:A0). For predictable performance, address and data inputs must be stable before a High-to-Low (WCLK) transition. This RAM block assumes an active-Low (WCLK). However, (WCLK) can be active-High or active-Low. Any inverter placed on the (WCLK) input net is absorbed into the block.

The signal output on the data output pin (O) is the data that is stored in the RAM at the location defined by the values on the address pins.

You can initialize this element during configuration using the INIT attribute.

Logic Table

Inputs			Outputs
WE (mode)	WCLK	D	O
0 (read)	X	X	Data
1 (read)	0	X	Data
1 (read)	1	X	Data
1 (write)	↓	D	D
1 (read)	↑	X	Data
Data = word addressed by bits A5:A0			

Design Entry Method

This design element can be used in schematics.

Available Attributes

Attribute	Data Type	Allowed Values	Default	Description
INIT	Hexadecimal	Any 64-Bit Value	All zeros	Initializes ROMs, RAMs, registers, and look-up tables.

For More Information

- See the [Spartan-3 Generation FPGA User Guide \(UG331\)](#).
- See the [Spartan-3E FPGA Family Data Sheet \(DS312\)](#).

RAM64X2S

Primitive: 64-Deep by 2-Wide Static Synchronous RAM

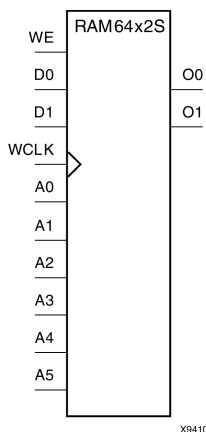

Introduction

This design element is a 64-word by 2-bit static random access memory with synchronous write capability. When the write enable (WE) is Low, transitions on the write clock (WCLK) are ignored and data stored in the RAM is not affected. When WE is High, any positive transition on WCLK loads the data on the data input (D1:D0) into the word selected by the 6-bit address (A5:A0). For predictable performance, address and data inputs must be stable before a Low-to-High WCLK transition. This RAM block assumes an active-High WCLK. However, WCLK can be active-High or active-Low. Any inverter placed on the WCLK input net is absorbed into the block.

The signal output on the data output pins (O1:O0) is the data that is stored in the RAM at the location defined by the values on the address pins. You can use the INIT_00 and INIT_01 properties to specify the initial contents of this design element.

Logic Table

Inputs			Outputs
WE (mode)	WCLK	D0:D1	O0:O1
0 (read)	X	X	Data
1 (read)	0	X	Data
1 (read)	1	X	Data
1 (write)	↑	D1:D0	D1:D0
1 (read)	↓	X	Data
Data = word addressed by bits A5:A0			

Design Entry Method

This design element is only for use in schematics.

Available Attributes

Attribute	Data Type	Allowed Values	Default	Description
INIT_00	Hexadecimal	Any 64-Bit Value	All zeros	Initializes RAMs, registers, and look-up tables.
INIT_01	Hexadecimal	Any 64-Bit Value	All zeros	Initializes RAMs, registers, and look-up tables.

For More Information

- See the [Spartan-3 Generation FPGA User Guide \(UG331\)](#).
- See the [Spartan-3E FPGA Family Data Sheet \(DS312\)](#).

RAMB16_S1

Primitive: 16K-bit Data and 2K-bit Parity Single-Port Synchronous Block RAM with 1-bit Port

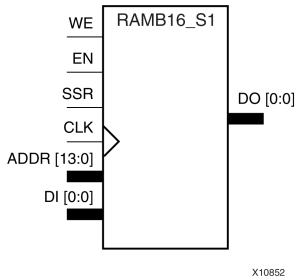

Introduction

This design element is a dedicated random access memory block with synchronous write capability. The block RAM port has 16384 bits of data memory. The cell configuration for this element is listed in the following table.

Data Cells		Parity Cells				
Depth	Width	Depth	Width	Address Bus	Data Bus	Parity Bus
16384	1	-	-	(13:0)	(0:0)	-

The enable EN pin controls read, write, and reset. When EN is Low, no data is written and the outputs (DO and DOP) retain the last state. When EN is High and reset (SSR) is High, DO and DOP are set to SRVAL during the Low-to-High clock (CLK) transition; if write enable (WE) is High, the memory contents reflect the data at DI and DIP. When EN is High and WE is Low, the data stored in the RAM address (ADDR) is read during the Low-to-High clock transition. By default, WRITE_MODE=WRITE_FIRST, when EN and WE are High, the data on the data inputs (DI and DIP) is loaded into the word selected by the write address (ADDR) during the Low-to-High clock transition and the data outputs (DO and DOP) reflect the selected (addressed) word.

The above description assumes an active High EN, WE, SSR, and CLK. However, the active level can be changed by placing an inverter on the port. Any inverter placed on a RAMB16 port is absorbed into the block and does not use a CLB resource.

Logic Table

Inputs								Outputs			
GSR	EN	SSR	WE	CLK	ADDR	DI	DIP	DO	DOP	RAM Contents	
										Data RAM	Parity RAM
1	X	X	X	X	X	X	X	INIT	INIT	No Change	No Change
0	0	X	X	X	X	X	X	No Change	No Change	No Change	No Change
0	1	1	0	↑	X	X	X	SRVAL	SRVAL	No Change	No Change
0	1	1	1	↑	addr	data	pdata	SRVAL	SRVAL	RAM(addr) =>data	RAM(addr) =>pdata
0	1	0	0	↑	addr	X	X	RAM (addr)	RAM (addr)	No Change	No Change
0	1	0	1	↑	addr	data	pdata	No Change ¹ RAM	No Change ¹ RAM	RAM (addr)=>data	RAM (addr)=>pdata

Inputs								Outputs			
GSR	EN	SSR	WE	CLK	ADDR	DI	DIP	DO	DOP	RAM Contents	
										Data RAM	Parity RAM
								(addr) ² data ³	(addr) ² pdata ³		
<p>GSR=Global Set Reset signal</p> <p>INIT=Value specified by the INIT attribute for data memory. Default is all zeros.</p> <p>SRVAL=Value after assertion of SSR as specified by the SRVAL attribute.</p> <p>addr=RAM address.</p> <p>RAM(addr)=RAM contents at address ADDR.</p> <p>data=RAM input data.</p> <p>pdata=RAM parity data.</p> <p>¹WRITE_MODE=NO_CHANGE</p> <p>²WRITE_MODE=READ_FIRST</p> <p>³WRITE_MODE=WRITE_FIRST</p>											

Initialization

Initializing Memory Contents

You can use the INIT_xx attributes to specify an initialization value for the memory contents of a RAMB16 during device configuration. The initialization of each RAMB16 is set by 64 initialization attributes (INIT_00 through INIT_3F) of 64 hex values for a total of 16384 bits.

You can use the INITP_xx attributes to specify an initial value for the parity memory during device configuration or assertion. The initialization of the parity memory for ports configured for 9, 18, or 36 bits is set by 8 initialization attributes (INITP_00 through INITP_07) of 64 hex values for a total of 2048 bits.

Any INIT_xx or INITP_xx attribute that is not specified is configured as zeros. Partial Strings are padded with zeros to the left.

Initializing the Output Register

In Spartan®-3A and above devices, each bit in the output register can be initialized at power on to either a 0 or 1. In addition, the initial state specified for power on can be different than the state that results from assertion of a set/reset. Two types of properties control initialization of the output register for a single-port RAMB16: INIT and SRVAL. The INIT attribute specifies the output register value at power on. You can use the SRVAL attribute to define the state resulting from assertion of the SSR (set/reset) input.

The INIT and SRVAL attributes specify the initialization value as a hexadecimal String containing one bit for each bit in the output port. For example, for a RAMB16_S1 with port width equal to 1, the output register contains 1 bit. Therefore, the INIT or SRVAL value can only be specified as a 1 or 0. For RAMB16_S4 with port width equal to 4, the output register contains 4 bits. In this case, you can specify a hexadecimal value from 0 through F to initialize the 4 bits of the output register.

For those ports that include parity bits, the parity portion of the output register is specified in the high order bit position of the INIT or SRVAL value.

Selecting Write Mode

The WRITE_MODE attribute controls RAMB16 memory and output contents. By default, the WRITE_MODE is set to WRITE_FIRST. This means that input is read, written to memory, and then passed to output. You can set the WRITE_MODE to READ_FIRST to read the memory contents, pass the memory contents to the outputs, and then write the input to memory. Or, you can set the WRITE_MODE to NO_CHANGE to have the input written to memory without changing the output.

Design Entry Method

This design element can be used in schematics.

Available Attributes

Attribute	Data Type	Allowed Values	Default	Description
INIT	Binary/ Hexadecimal	Any Hex Value	All zeros	Identifies the initial value of the DO output port after completing configuration. The bit width is dependent on the width of the A or B port of the RAM.
INIT_00 to INIT_3F	Binary/ Hexadecimal	Any Hex Value	All zeros	Specifies the initial contents of the data portion of the RAM array.
INITP_00 to INITP_07	Binary/ Hexadecimal	Any Hex Value	All zeros	Specifies the initial contents of the parity portion of the RAM array.
SRVAL	Binary/ Hexadecimal	Any Hex Value	All zeros	Allows the individual selection of whether the DO output port sets (go to a one) or reset (go to a zero) upon the assertion of the SSR pin. The bit width is dependent on the width of the A or B port of the RAM.
WRITE_MODE	String	"WRITE_FIRST", "READ_FIRST" or "NO_CHANGE"	"WRITE_FIRST"	Specifies the behavior of the DO port upon a write command to the respected port. If set to "WRITE_FIRST", the same port that is written to displays the contents of the written data to the outputs upon completion of the operation. "READ_FIRST" displays the prior contents of the RAM to the output port prior to writing the new data. "NO_CHANGE" keeps the previous value on the output port and won't update the output port upon a write command. This is the suggested mode if not using the read data from a particular port of the RAM.

For More Information

- See the [Spartan-3 Generation FPGA User Guide \(UG331\)](#).
- See the [Spartan-3E FPGA Family Data Sheet \(DS312\)](#).

RAMB16_S1_S1

Primitive: 16K-bit Data and 2K-bit Parity Dual-Port Synchronous Block RAM with 1-bit Ports

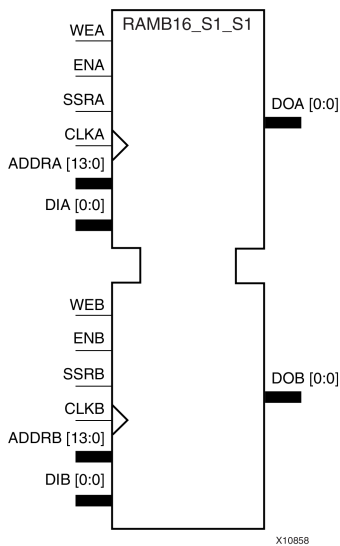

Introduction

This design element is a dual-ported dedicated random access memory block with synchronous write capability. Each block RAM port has 16384 bits of data memory. Ports configured as 9, 18, or 36 bits wide have an additional 2048 bits of parity memory. Each port is independent of the other while accessing the same set of 16384 data memory cells. Each port is independently configured to a specific data width. The possible port and cell configurations for this element are listed in the "Port Descriptions" section.

Logic Table

Truth Table A

Inputs								Outputs			
GSR	ENA	SSRA	WEA	CLKA	ADDR	DIA	DIPA	DOA	DOPA	RAM Contents	
										Data RAM	Parity RAM
1	X	X	X	X	X	X	X	INIT_A	INIT_A	No Change	No Change
0	0	X	X	X	X	X	X	No Change	No Change	No Change	No Change
0	1	1	0	↑	X	X	X	SRVAL_A	SRVAL_A	No Change	No Change
0	1	1	1	↑	addr	data	pdata	SRVAL_A	SRVAL_A	RAM(addr) =>data	RAM(addr) =>pdata
0	1	0	0	↑	addr	X	X	RAM(addr)	RAM(addr)	No Change	No Change
0	1	0	1	↑	addr	data	pdata	No Change ¹ , RAM(addr) ² , data ³	No Change ¹ , RAM(addr) ² , pdata ³	RAM(addr) =>data	RAM(addr) =>pdata

GSR=Global Set Reset.

INIT_A=Value specified by the INIT_A attribute for output register. Default is all zeros.

SRVAL_A=register value.

addr=RAM address.

RAM(addr)=RAM contents at address ADDR.

data=RAM input data.

pdata=RAM parity data.

¹WRITE_MODE_A=NO_CHANGE.

²WRITE_MODE_A=READ_FIRST.

³WRITE_MODE_A=WRITE_FIRST.

Truth Table B

Inputs								Outputs			
GSR	ENB	SSRB	WEB	CLKB	ADDRB	DIB	DIPB	DOB	DOPB	RAM Contents	
										Data RAM	Parity RAM
1	X	X	X	X	X	X	X	INIT_B	INIT_B	No Change	No Change
0	0	X	X	X	X	X	X	No Change	No Change	No Change	No Change
0	1	1	0	↑	X	X	X	SRVAL_B	SRVAL_B	No Change	No Change
0	1	1	1	↑	addr	data	pdata	SRVAL_B	SRVAL_B	RAM(addr) =>data	RAM(addr) =>pdata
0	1	0	0	↑	addr	X	X	RAM(addr)	RAM(addr)	No Change	No Change
0	1	0	1	↑	addr	data	pdata	No Change ¹ , RAM(addr) ² , data ³	No Change ¹ , RAM(addr) ² , pdata ³	RAM(addr) =>data	RAM(addr) =>pdata

GSR=Global Set Reset.
 INIT_B=Value specified by the INIT_B attribute for output registers. Default is all zeros.
 SRVAL_B=register value.
 addr=RAM address.
 RAM(addr)=RAM contents at address ADDR.
 data=RAM input data.
 pdata=RAM parity data.
¹WRITE_MODE_B=NO_CHANGE.
²WRITE_MODE_B=READ_FIRST.
³WRITE_MODE_B=WRITE_FIRST.

Port Descriptions

Port A						Port B				
Design Element	Data Cells ¹	Parity Cells ¹	Address Bus	Data Bus	Parity Bus	Data Cells ¹	Parity Cells ¹	Address Bus	Data Bus	Parity Bus
RAMB16_S1_S1	16384 x 1	-	(13:0)	(0:0)	-	16384 x 1	-	(13:0)	(0:0)	-

¹Depth x Width

Each port is fully synchronous with independent clock pins. All Port A input pins have setup time referenced to the CLKA pin and its data output bus DOA has a clock-to-out time referenced to the CLKA. All Port B input pins have setup time referenced to the CLKB pin and its data output bus DOB has a clock-to-out time referenced to the CLKB. The enable ENA pin controls read, write, and reset for Port A. When ENA is Low, no data is written and the outputs (DOA and DOPA) retain the last state. When ENA is High and reset (SSRA) is High, DOA and DOPA are set to SRVAL_A during the Low-to-High clock (CLKA) transition; if write enable (WEA) is High, the memory contents reflect the data at DIA and DIPA. When ENA is High and WEA is Low, the data stored in the RAM address (ADDR_A) is read during the Low-to-High clock transition. By default, WRITE_MODE_A=WRITE_FIRST, when ENA and WEA are High, the data on the data inputs (DIA and DIPA) is loaded into the word selected by the write address (ADDR_A) during the Low-to-High clock transition and the data outputs (DOA and DOPA) reflect the selected (addressed) word.

The enable ENB pin controls read, write, and reset for Port B. When ENB is Low, no data is written and the outputs (DOB and DOPB) retain the last state. When ENB is High and reset (SSRB) is High, DOB and DOPB are set to SRVAL_B during the Low-to-High clock (CLKB) transition; if write enable (WEB) is High, the memory contents reflect the data at DIB and DIPB. When ENB is High and WEB is Low, the data stored in the RAM address (ADDRB) is read during the Low-to-High clock transition. By default, WRITE_MODE_B=WRITE_FIRST, when ENB and WEB are High, the data on the data inputs (DIB and PB) are loaded into the word selected by the write address (ADDRB) during the Low-to-High clock transition and the data outputs (DOB and DOPB) reflect the selected (addressed) word. The above descriptions assume active High control pins (ENA, WEA, SSRA, CLKA, ENB, WEB, SSRB, and CLKB). However, the active level can be changed by placing an inverter on the port. Any inverter placed on a RAMB16 port is absorbed into the block and does not use a CLB resource.

Address Mapping

Each port accesses the same set of 18432 memory cells using an addressing scheme that is dependent on the width of the port. For all port widths, 16384 memory cells are available for data as shown in the Port Address Mapping for Data table below. For 9-, 18-, and 36-bit wide ports, 2408 parity memory cells are also available as shown in Port Address Mapping for Parity table below. The physical RAM location that is addressed for a particular width is determined from the following formula.

$$\text{Start} = ((\text{ADDR port} + 1) * (\text{Widthport})) - 1$$

$$\text{End} = (\text{ADDRport}) * (\text{Widthport})$$

The following tables shows address mapping for each port width.

Port Address Mapping for Data

Data Width	Port Data Addresses																																	
1	16384	<--	31	30	29	28	27	26	25	24	23	22	21	20	19	18	17	16	15	14	13	12	11	10	9	8	7	6	5	4	3	2	1	0
2	8192	<--	15	14	13	12	11	10	9	8	7	6	5	4	3	2	1	0																
4	4096	<--	7	6	5	4	3	2	1	0																								
8	2048	<--	3	2	1	0																												
16	1024	<--	1	0																														
32	512	<--	0																															

Port Address Mapping for Parity

Parity Width	Port Parity Addresses															
1	2048	<-----	3	2	1	0										
2	1024	<-----	1	0												
4	512	<-----	0													

Initializing Memory Contents of a Dual-Port RAMB16

You can use the INIT_xx attributes to specify an initialization value for the memory contents of a RAMB16 during device configuration. The initialization of each RAMB16_Sm_Sn is set by 64 initialization attributes (INIT_00 through INIT_3F) of 64 hex values for a total of 16384 bits.

You can use the INITP_xx attributes to specify an initial value for the parity memory during device configuration or assertion. The initialization of the parity memory for ports configured for 9, 18, or 36 bits is set by 8 initialization attributes (INITP_00 through INITP_07) of 64 hex values for a total of 2048 bits.

If any INIT_xx or INITP_xx attribute is not specified, it is configured as zeros. Partial Strings are padded with zeros to the left.

Initializing the Output Register of a Dual-Port RAMB16

In Spartan®-3A and above devices, each bit in an output register can be initialized at power on (when GSR is high) to either a 0 or 1. In addition, the initial state specified for power on can be different than the state that results from assertion of a set/reset. Four properties control initialization of the output register for a dual-port RAMB16: INIT_A, INIT_B, SRVAL_A, and SRVAL_B. The INIT_A attribute specifies the output register value at power on for Port A and the INIT_B attribute specifies the value for Port B. You can use the SRVAL_A attribute to define the state resulting from assertion of the SSR (set/reset) input on Port A. You can use the SRVAL_B attribute to define the state resulting from assertion of the SSR input on Port B.

The INIT_A, INIT_B, SRVAL_A, and SRVAL_B attributes specify the initialization value as a hexadecimal String. The value is dependent upon the port width. For example, for a RAMB16_S1_S4 with Port A width equal to 1 and Port B width equal to 4, the Port A output register contains 1 bit and the Port B output register contains 4 bits. Therefore, the INIT_A or SRVAL_A value can only be specified as a 1 or 0. For Port B, the output register contains 4 bits. In this case, you can use INIT_B or SRVAL_B to specify a hexadecimal value from 0 through F to initialize the 4 bits of the output register.

For those ports that include parity bits, the parity portion of the output register is specified in the high order bit position of the INIT_A, INIT_B, SRVAL_A, or SRVAL_B value.

The INIT and SRVAL attributes default to zero if they are not set by you.

Write Mode Selection

The WRITE_MODE_A attribute controls the memory and output contents of Port A for a dual-port RAMB16. The WRITE_MODE_B attribute does the same for Port B. By default, both WRITE_MODE_A and WRITE_MODE_B are set to WRITE_FIRST. This means that input is read, written to memory, and then passed to output. You can set the write mode for Port A and Port B to READ_FIRST to read the memory contents, pass the memory contents to the outputs, and then write the input to memory. Or, you can set the write mode to NO_CHANGE to have the input written to memory without changing the output. The Port A and Port B Conflict Resolution section describes how read/write conflicts are resolved when both Port A and Port B are attempting to read/write to the same memory cells.

Port A and Port B Conflict Resolution

Spartan-3A block SelectRAM™ is True Dual-Port RAM that allows both ports to simultaneously access the same memory cell. When one port writes to a given memory cell, the other port must not address that memory cell (for a write or a read) within the clock-to-clock setup window.

The following tables summarize the collision detection behavior of the dual-port RAMB16 based on the WRITE_MODE_A and WRITE_MODE_B settings.

WRITE_MODE_A=NO_CHANGE and WRITE_MODE_B=NO_CHANGE

WEA	WEB	CLKA	CLKB	DIA	DIB	DIPA	DIPB	DOA	DOB	DOPA	DOPB	Data RAM	Parity Ram
0	0	↑	↑	DIA	DIB	DIPA	DIPB	RAM	RAM	RAM	RAM	No Change	No Change
1	0	↑	↑	DIA	DIB	DIPA	DIPB	No Change	X	No Change	X	DIA	DIPA

WEA	WEB	CLKA	CLKB	DIA	DIB	DIPA	DIPB	DOA	DOB	DOPA	DOPB	Data RAM	Parity Ram
0	1	↑	↑	DIA	DIB	DIPA	DIPB	X	No Change	X	No Change	DIB	DIPB
1	1	↑	↑	DIA	DIB	DIPA	DIPB	No Change	No Change	No Change	No Change	X	X

WRITE_MODE_A=READ_FIRST and WRITE_MODE_B=READ_FIRST

WEA	WEB	CLKA	CLKB	DIA	DIB	DIPA	DIPB	DOA	DOB	DOPA	DOPB	Data RAM	Parity Ram
0	0	↑	↑	DIA	DIB	DIPA	DIPB	RAM	RAM	RAM	RAM	No Change	No Change
1	0	↑	↑	DIA	DIB	DIPA	DIPB	RAM	RAM	RAM	RAM	DIA	DIPA
0	1	↑	↑	DIA	DIB	DIPA	DIPB	RAM	RAM	RAM	RAM	DIB	DIPB
1	1	↑	↑	DIA	DIB	DIPA	DIPB	RAM	RAM	RAM	RAM	X	X

WRITE_MODE_A= WRITE_FIRST and WRITE_MODE_B=WRITE_FIRST

WEA	WEB	CLKA	CLKB	DIA	DIB	DIPA	DIPB	DOA	DOB	DOPA	DOPB	Data RAM	Parity Ram
0	0	↑	↑	DIA	DIB	DIPA	DIPB	RAM	RAM	RAM	RAM	No Change	No Change
1	0	↑	↑	DIA	DIB	DIPA	DIPB	DIA	X	DIPA	X	DIA	DIPA
0	1	↑	↑	DIA	DIB	DIPA	DIPB	X	DIB	X	DIPB	DIB	DIPB
1	1	↑	↑	DIA	DIB	DIPA	DIPB	X	X	X	X	X	X

WRITE_MODE_A=NO_CHANGE and WRITE_MODE_B=READ_FIRST

WEA	WEB	CLKA	CLKB	DIA	DIB	DIPA	DIPB	DOA	DOB	DOPA	DOPB	Data RAM	Parity Ram
0	0	↑	↑	DIA	DIB	DIPA	DIPB	RAM	RAM	RAM	RAM	No Change	No Change
1	0	↑	↑	DIA	DIB	DIPA	DIPB	No Change	X	No Change	X	DIA	DIPA
0	1	↑	↑	DIA	DIB	DIPA	DIPB	RAM	RAM	RAM	RAM	DIB	DIPB
1	1	↑	↑	DIA	DIB	DIPA	DIPB	No Change	X	No Change	X	DIB	DIPB

WRITE_MODE_A=NO_CHANGE and WRITE_MODE_B=WRITE_FIRST

WEA	WEB	CLKA	CLKB	DIA	DIB	DIPA	DIPB	DOA	DOB	DOPA	DOPB	Data RAM	Parity Ram
0	0	↑	↑	DIA	DIB	DIPA	DIPB	RAM	RAM	RAM	RAM	No Change	No Change
1	0	↑	↑	DIA	DIB	DIPA	DIPB	No Change	X	No Change	X	DIA	DIPA
0	1	↑	↑	DIA	DIB	DIPA	DIPB	X	DIB	X	DIPB	DIB	DIPB
1	1	↑	↑	DIA	DIB	DIPA	DIPB	No Change	X	No Change	X	X	X

WRITE_MODE_A=READ_FIRST and WRITE_MODE_B=WRITE_FIRST

WEA	WEB	CLKA	CLKB	DIA	DIB	DIPA	DIPB	DOA	DOB	DOPA	DOPB	Data RAM	Parity Ram
0	0	↑	↑	DIA	DIB	DIPA	DIPB	RAM	RAM	RAM	RAM	No Change	No Change
1	0	↑	↑	DIA	DIB	DIPA	DIPB	RAM	RAM	RAM	RAM	DIA	DIPA
0	1	↑	↑	DIA	DIB	DIPA	DIPB	X	DIB	X	DIPB	DIB	DIPB
1	1	↑	↑	DIA	DIB	DIPA	DIPB	X	DIB	X	DIPB	DIA	DIPA

Design Entry Method

This design element can be used in schematics.

Available Attributes

Attribute	Data Type	Allowed Values	Default	Description
INIT_00 to INIT_3F	Binary/ Hexadecimal	Any	All zeros	Specifies the initial contents of the data portion of the RAM array.
INIT_A	Binary/ Hexadecimal	Any	All zeros	Specifies the initial value of the DOA output port after completing configuration. For Type, the bit width is dependent on the width of the A port of the RAM.
INIT_B	Binary/ Hexadecimal	Any	All zeros	Specifies the initial value of the DOB output port after completing configuration. For Type, the bit width is dependent on the width of the B port of the RAM.
INITP_00 to INITP_07	Binary/ Hexadecimal	Any	All zeros	Specifies the initial contents of the parity portion of the RAM array.
SIM_COLLISION_CHECK	String	"ALL", "WARNING_ONLY", "GENERATE_X_ONLY", "NONE"	"ALL"	<p>Allows modification of the simulation behavior if a memory collision occurs. The output is affected as follows:</p> <ul style="list-style-type: none"> "ALL" - Warning produced and affected outputs/memory location go unknown (X). "WARNING_ONLY" - Warning produced and affected outputs/memory retain last value. "GENERATE_X_ONLY" - No warning. However, affected outputs/memory go unknown (X). "NONE" - No warning and affected outputs/memory retain last value. <p>Note Setting this to a value other than "ALL" can allow problems in the design go unnoticed during simulation. Care should be taken when changing the value of this attribute. Please see the <i>Synthesis and Simulation Design Guide</i> for more information.</p>
SRVAL_A	Binary/ Hexadecimal	Any	All zeros	Sets on a per-bit basis whether the DOA output port sets (goes to a one) or resets (goes to a zero) upon the assertion of the RSTA pin. For Type, the bit width is dependent on the width of the A port of the RAM. Default is all bits reset.

Attribute	Data Type	Allowed Values	Default	Description
SRVAL_B	Binary/ Hexadecimal	Any	All zeros	Sets on a per-bit basis whether the DOB output port sets (goes to a one) or resets (goes to a zero) upon the assertion of the RSTB pin. For Type, the bit width is dependent on the width of the B port of the RAM. Default is all bits reset.
WRITE_MODE_A	String	"WRITE_FIRST", "READ_FIRST", "NO_CHANGE"	"WRITE_FIRST"	Specifies the behavior of the DOA port upon a write command to the port. <ul style="list-style-type: none"> "WRITE_FIRST" - the same port that is written to displays the contents of the written data to the outputs upon completion of the operation. "READ_FIRST" - displays the prior contents of the RAM to the output port prior to writing the new data. "NO_CHANGE" - keeps the previous value on the output port and does not update the output port upon a write command. This is the suggested mode if not using the read data from a particular port of the RAM.
WRITE_MODE_B	String	"WRITE_FIRST", "READ_FIRST", "NO_CHANGE"	"WRITE_FIRST"	Specifies the behavior of the DOB port upon a write command to the port. <ul style="list-style-type: none"> "WRITE_FIRST" - the same port that is written to displays the contents of the written data to the outputs upon completion of the operation. "READ_FIRST" - displays the prior contents of the RAM to the output port prior to writing the new data. "NO_CHANGE" - keeps the previous value on the output port and does not update the output port upon a write command. This is the suggested mode if not using the read data from a particular port of the RAM.

For More Information

- See the [Spartan-3 Generation FPGA User Guide \(UG331\)](#).
- See the [Spartan-3E FPGA Family Data Sheet \(DS312\)](#).

RAMB16_S1_S18

Primitive: 16K-bit Data and 2K-bit Parity Dual-Port Synchronous Block RAM with 1-bit and 18-bit Ports

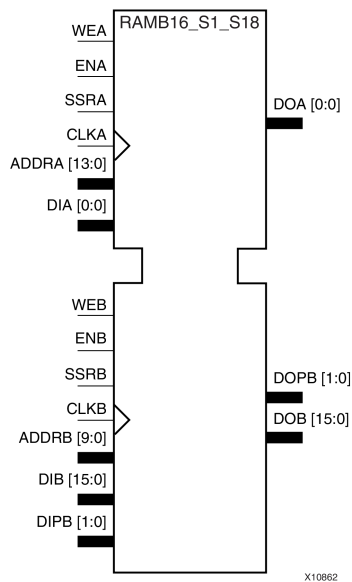

Introduction

This design element is a dual-ported dedicated random access memory block with synchronous write capability. Each block RAM port has 16384 bits of data memory. Ports configured as 9, 18, or 36 bits wide have an additional 2048 bits of parity memory. Each port is independent of the other while accessing the same set of 16384 data memory cells. Each port is independently configured to a specific data width. The possible port and cell configurations for this element are listed in the "Port Descriptions" section.

Logic Table

Truth Table A

Inputs								Outputs			
GSR	ENA	SSRA	WEA	CLKA	ADDR	DIA	DIPA	DOA	DOPA	RAM Contents	
										Data RAM	Parity RAM
1	X	X	X	X	X	X	X	INIT_A	INIT_A	No Change	No Change
0	0	X	X	X	X	X	X	No Change	No Change	No Change	No Change
0	1	1	0	↑	X	X	X	SRVAL_A	SRVAL_A	No Change	No Change
0	1	1	1	↑	addr	data	pdata	SRVAL_A	SRVAL_A	RAM(addr) =>data	RAM(addr) =>pdata
0	1	0	0	↑	addr	X	X	RAM(addr)	RAM(addr)	No Change	No Change
0	1	0	1	↑	addr	data	pdata	No Change ¹ , RAM(addr) ² , data ³	No Change ¹ , RAM(addr) ² , pdata ³	RAM(addr) =>data	RAM(addr) =>pdata

GSR=Global Set Reset.

INIT_A=Value specified by the INIT_A attribute for output register. Default is all zeros.

SRVAL_A=register value.

addr=RAM address.

RAM(addr)=RAM contents at address ADDR.

data=RAM input data.

pdata=RAM parity data.

¹WRITE_MODE_A=NO_CHANGE.

²WRITE_MODE_A=READ_FIRST.

³WRITE_MODE_A=WRITE_FIRST.

Truth Table B

Inputs								Outputs			
GSR	ENB	SSRB	WEB	CLKB	ADDRB	DIB	DIPB	DOB	DOPB	RAM Contents	
										Data RAM	Parity RAM
1	X	X	X	X	X	X	X	INIT_B	INIT_B	No Change	No Change
0	0	X	X	X	X	X	X	No Change	No Change	No Change	No Change
0	1	1	0	↑	X	X	X	SRVAL_B	SRVAL_B	No Change	No Change
0	1	1	1	↑	addr	data	pdata	SRVAL_B	SRVAL_B	RAM(addr) =>data	RAM(addr) =>pdata
0	1	0	0	↑	addr	X	X	RAM(addr)	RAM(addr)	No Change	No Change
0	1	0	1	↑	addr	data	pdata	No Change ¹ , RAM(addr) ² , data ³	No Change ¹ , RAM(addr) ² , pdata ³	RAM(addr) =>data	RAM(addr) =>pdata

GSR=Global Set Reset.
 INIT_B=Value specified by the INIT_B attribute for output registers. Default is all zeros.
 SRVAL_B=register value.
 addr=RAM address.
 RAM(addr)=RAM contents at address ADDR.
 data=RAM input data.
 pdata=RAM parity data.
¹WRITE_MODE_B=NO_CHANGE.
²WRITE_MODE_B=READ_FIRST.
³WRITE_MODE_B=WRITE_FIRST.

Port Descriptions

Port A						Port B				
Design Element	Data Cells ¹	Parity Cells ¹	Address Bus	Data Bus	Parity Bus	Data Cells ¹	Parity Cells ¹	Address Bus	Data Bus	Parity Bus
RAMB16_S1_S18	16384 x 1	-	(13:0)	(0:0)	-	1024 x 16	1024 x 2	(9:0)	(15:0)	(1:0)

¹ Depth x Width

Each port is fully synchronous with independent clock pins. All Port A input pins have setup time referenced to the CLKA pin and its data output bus DOA has a clock-to-out time referenced to the CLKA. All Port B input pins have setup time referenced to the CLKB pin and its data output bus DOB has a clock-to-out time referenced to the CLKB. The enable ENA pin controls read, write, and reset for Port A. When ENA is Low, no data is written and the outputs (DOA and DOPA) retain the last state. When ENA is High and reset (SSRA) is High, DOA and DOPA are set to SRVAL_A during the Low-to-High clock (CLKA) transition; if write enable (WEA) is High, the memory contents reflect the data at DIA and DIPB. When ENA is High and WEA is Low, the data stored in the RAM address (ADDRB) is read during the Low-to-High clock transition. By default, WRITE_MODE_A=WRITE_FIRST, when ENA and WEA are High, the data on the data inputs (DIA and DIPB) is loaded into the word selected by the write address (ADDRB) during the Low-to-High clock transition and the data outputs (DOA and DOPA) reflect the selected (addressed) word.

The enable ENB pin controls read, write, and reset for Port B. When ENB is Low, no data is written and the outputs (DOB and DOPB) retain the last state. When ENB is High and reset (SSRB) is High, DOB and DOPB are set to SRVAL_B during the Low-to-High clock (CLKB) transition; if write enable (WEB) is High, the memory contents reflect the data at DIB and DIPB. When ENB is High and WEB is Low, the data stored in the RAM address (ADDRB) is read during the Low-to-High clock transition. By default, WRITE_MODE_B=WRITE_FIRST, when ENB and WEB are High, the data on the data inputs (DIB and PB) are loaded into the word selected by the write address (ADDRB) during the Low-to-High clock transition and the data outputs (DOB and DOPB) reflect the selected (addressed) word. The above descriptions assume active High control pins (ENA, WEA, SSRA, CLKA, ENB, WEB, SSRB, and CLKB). However, the active level can be changed by placing an inverter on the port. Any inverter placed on a RAMB16 port is absorbed into the block and does not use a CLB resource.

Address Mapping

Each port accesses the same set of 18432 memory cells using an addressing scheme that is dependent on the width of the port. For all port widths, 16384 memory cells are available for data as shown in the Port Address Mapping for Data table below. For 9-, 18-, and 36-bit wide ports, 2408 parity memory cells are also available as shown in Port Address Mapping for Parity table below. The physical RAM location that is addressed for a particular width is determined from the following formula.

$$\text{Start} = ((\text{ADDR port} + 1) * (\text{Widthport})) - 1$$

$$\text{End} = (\text{ADDRport}) * (\text{Widthport})$$

The following tables shows address mapping for each port width.

Port Address Mapping for Data

Data Width	Port Data Addresses																																	
1	16384	<--	31	30	29	28	27	26	25	24	23	22	21	20	19	18	17	16	15	14	13	12	11	10	9	8	7	6	5	4	3	2	1	0
2	8192	<--	15		14		13		12		11		10		9		8		7		6		5		4		3		2		1		0	
4	4096	<--	7				6				5				4				3				2				1				0			
8	2048	<--	3								2								1								0							
16	1024	<--	1																0															
32	512	<--	0																															

Port Address Mapping for Parity

Parity Width	Port Parity Addresses																															
1	2048	<-----	3							2					1																	0
2	1024	<-----	1												0																	
4	512	<-----	0																													

Initializing Memory Contents of a Dual-Port RAMB16

You can use the INIT_xx attributes to specify an initialization value for the memory contents of a RAMB16 during device configuration. The initialization of each RAMB16_Sm_Sn is set by 64 initialization attributes (INIT_00 through INIT_3F) of 64 hex values for a total of 16384 bits.

You can use the INITP_xx attributes to specify an initial value for the parity memory during device configuration or assertion. The initialization of the parity memory for ports configured for 9, 18, or 36 bits is set by 8 initialization attributes (INITP_00 through INITP_07) of 64 hex values for a total of 2048 bits.

If any INIT_xx or INITP_xx attribute is not specified, it is configured as zeros. Partial Strings are padded with zeros to the left.

Initializing the Output Register of a Dual-Port RAMB16

In Spartan®-3A and above devices, each bit in an output register can be initialized at power on (when GSR is high) to either a 0 or 1. In addition, the initial state specified for power on can be different than the state that results from assertion of a set/reset. Four properties control initialization of the output register for a dual-port RAMB16: INIT_A, INIT_B, SRVAL_A, and SRVAL_B. The INIT_A attribute specifies the output register value at power on for Port A and the INIT_B attribute specifies the value for Port B. You can use the SRVAL_A attribute to define the state resulting from assertion of the SSR (set/reset) input on Port A. You can use the SRVAL_B attribute to define the state resulting from assertion of the SSR input on Port B.

The INIT_A, INIT_B, SRVAL_A, and SRVAL_B attributes specify the initialization value as a hexadecimal String. The value is dependent upon the port width. For example, for a RAMB16_S1_S4 with Port A width equal to 1 and Port B width equal to 4, the Port A output register contains 1 bit and the Port B output register contains 4 bits. Therefore, the INIT_A or SRVAL_A value can only be specified as a 1 or 0. For Port B, the output register contains 4 bits. In this case, you can use INIT_B or SRVAL_B to specify a hexadecimal value from 0 through F to initialize the 4 bits of the output register.

For those ports that include parity bits, the parity portion of the output register is specified in the high order bit position of the INIT_A, INIT_B, SRVAL_A, or SRVAL_B value.

The INIT and SRVAL attributes default to zero if they are not set by you.

Write Mode Selection

The WRITE_MODE_A attribute controls the memory and output contents of Port A for a dual-port RAMB16. The WRITE_MODE_B attribute does the same for Port B. By default, both WRITE_MODE_A and WRITE_MODE_B are set to WRITE_FIRST. This means that input is read, written to memory, and then passed to output. You can set the write mode for Port A and Port B to READ_FIRST to read the memory contents, pass the memory contents to the outputs, and then write the input to memory. Or, you can set the write mode to NO_CHANGE to have the input written to memory without changing the output. The Port A and Port B Conflict Resolution section describes how read/write conflicts are resolved when both Port A and Port B are attempting to read/write to the same memory cells.

Port A and Port B Conflict Resolution

Spartan-3A block SelectRAM™ is True Dual-Port RAM that allows both ports to simultaneously access the same memory cell. When one port writes to a given memory cell, the other port must not address that memory cell (for a write or a read) within the clock-to-clock setup window.

The following tables summarize the collision detection behavior of the dual-port RAMB16 based on the WRITE_MODE_A and WRITE_MODE_B settings.

WRITE_MODE_A=NO_CHANGE and WRITE_MODE_B=NO_CHANGE

WEA	WEB	CLKA	CLKB	DIA	DIB	DIPA	DIPB	DOA	DOB	DOPA	DOPB	Data RAM	Parity Ram
0	0	↑	↑	DIA	DIB	DIPA	DIPB	RAM	RAM	RAM	RAM	No Change	No Change
1	0	↑	↑	DIA	DIB	DIPA	DIPB	No Change	X	No Change	X	DIA	DIPA
0	1	↑	↑	DIA	DIB	DIPA	DIPB	X	No Change	X	No Change	DIB	DIPB
1	1	↑	↑	DIA	DIB	DIPA	DIPB	No Change	No Change	No Change	No Change	X	X

WRITE_MODE_A=READ_FIRST and WRITE_MODE_B=READ_FIRST

WEA	WEB	CLKA	CLKB	DIA	DIB	DIPA	DIPB	DOA	DOB	DOPA	DOPB	Data RAM	Parity Ram
0	0	↑	↑	DIA	DIB	DIPA	DIPB	RAM	RAM	RAM	RAM	No Change	No Change
1	0	↑	↑	DIA	DIB	DIPA	DIPB	RAM	RAM	RAM	RAM	DIA	DIPA
0	1	↑	↑	DIA	DIB	DIPA	DIPB	RAM	RAM	RAM	RAM	DIB	DIPB
1	1	↑	↑	DIA	DIB	DIPA	DIPB	RAM	RAM	RAM	RAM	X	X

WRITE_MODE_A= WRITE_FIRST and WRITE_MODE_B=WRITE_FIRST

WEA	WEB	CLKA	CLKB	DIA	DIB	DIPA	DIPB	DOA	DOB	DOPA	DOPB	Data RAM	Parity Ram
0	0	↑	↑	DIA	DIB	DIPA	DIPB	RAM	RAM	RAM	RAM	No Change	No Change
1	0	↑	↑	DIA	DIB	DIPA	DIPB	DIA	X	DIPA	X	DIA	DIPA
0	1	↑	↑	DIA	DIB	DIPA	DIPB	X	DIB	X	DIPB	DIB	DIPB
1	1	↑	↑	DIA	DIB	DIPA	DIPB	X	X	X	X	X	X

WRITE_MODE_A=NO_CHANGE and WRITE_MODE_B=READ_FIRST

WEA	WEB	CLKA	CLKB	DIA	DIB	DIPA	DIPB	DOA	DOB	DOPA	DOPB	Data RAM	Parity Ram
0	0	↑	↑	DIA	DIB	DIPA	DIPB	RAM	RAM	RAM	RAM	No Change	No Change
1	0	↑	↑	DIA	DIB	DIPA	DIPB	No Change	X	No Change	X	DIA	DIPA
0	1	↑	↑	DIA	DIB	DIPA	DIPB	RAM	RAM	RAM	RAM	DIB	DIPB
1	1	↑	↑	DIA	DIB	DIPA	DIPB	No Change	X	No Change	X	DIB	DIPB

WRITE_MODE_A=NO_CHANGE and WRITE_MODE_B=WRITE_FIRST

WEA	WEB	CLKA	CLKB	DIA	DIB	DIPA	DIPB	DOA	DOB	DOPA	DOPB	Data RAM	Parity Ram
0	0	↑	↑	DIA	DIB	DIPA	DIPB	RAM	RAM	RAM	RAM	No Change	No Change
1	0	↑	↑	DIA	DIB	DIPA	DIPB	No Change	X	No Change	X	DIA	DIPA
0	1	↑	↑	DIA	DIB	DIPA	DIPB	X	DIB	X	DIPB	DIB	DIPB
1	1	↑	↑	DIA	DIB	DIPA	DIPB	No Change	X	No Change	X	X	X

WRITE_MODE_A=READ_FIRST and WRITE_MODE_B=WRITE_FIRST

WEA	WEB	CLKA	CLKB	DIA	DIB	DIPA	DIPB	DOA	DOB	DOPA	DOPB	Data RAM	Parity Ram
0	0	↑	↑	DIA	DIB	DIPA	DIPB	RAM	RAM	RAM	RAM	No Change	No Change
1	0	↑	↑	DIA	DIB	DIPA	DIPB	RAM	RAM	RAM	RAM	DIA	DIPA

WEA	WEB	CLKA	CLKB	DIA	DIB	DIPA	DIPB	DOA	DOB	DOPA	DOPB	Data RAM	Parity Ram
0	1	↑	↑	DIA	DIB	DIPA	DIPB	X	DIB	X	DIPB	DIB	DIPB
1	1	↑	↑	DIA	DIB	DIPA	DIPB	X	DIB	X	DIPB	DIA	DIPA

Design Entry Method

This design element can be used in schematics.

Available Attributes

Attribute	Data Type	Allowed Values	Default	Description
INIT_00 to INIT_3F	Binary/ Hexadecimal	Any	All zeros	Specifies the initial contents of the data portion of the RAM array.
INIT_A	Binary/ Hexadecimal	Any	All zeros	Specifies the initial value of the DOA output port after completing configuration. For Type, the bit width is dependent on the width of the A port of the RAM.
INIT_B	Binary/ Hexadecimal	Any	All zeros	Specifies the initial value of the DOB output port after completing configuration. For Type, the bit width is dependent on the width of the B port of the RAM.
INITP_00 to INITP_07	Binary/ Hexadecimal	Any	All zeros	Specifies the initial contents of the parity portion of the RAM array.
SIM_COLLISION_CHECK	String	"ALL", "WARNING_ONLY", "GENERATE_X_ONLY", "NONE"	"ALL"	<p>Allows modification of the simulation behavior if a memory collision occurs. The output is affected as follows:</p> <ul style="list-style-type: none"> "ALL" - Warning produced and affected outputs/memory location go unknown (X). "WARNING_ONLY" - Warning produced and affected outputs/memory retain last value. "GENERATE_X_ONLY" - No warning. However, affected outputs/memory go unknown (X). "NONE" - No warning and affected outputs/memory retain last value. <p>Note Setting this to a value other than "ALL" can allow problems in the design go unnoticed during simulation. Care should be taken when changing the value of this attribute. Please see the <i>Synthesis and Simulation Design Guide</i> for more information.</p>
SRVAL_A	Binary/ Hexadecimal	Any	All zeros	Sets on a per-bit basis whether the DOA output port sets (goes to a one) or resets (goes to a zero) upon the assertion of the RSTA pin. For Type, the bit width is dependent on the width of the A port of the RAM. Default is all bits reset.
SRVAL_B	Binary/ Hexadecimal	Any	All zeros	Sets on a per-bit basis whether the DOB output port sets (goes to a one) or resets (goes to a zero) upon the assertion of the RSTB pin. For Type, the bit width is dependent on the width of the B port of the RAM. Default is all bits reset.

Attribute	Data Type	Allowed Values	Default	Description
WRITE_MODE_A	String	"WRITE_FIRST", "READ_FIRST", "NO_CHANGE"	"WRITE_FIRST"	<p>Specifies the behavior of the DOA port upon a write command to the port.</p> <ul style="list-style-type: none"> "WRITE_FIRST" - the same port that is written to displays the contents of the written data to the outputs upon completion of the operation. "READ_FIRST" - displays the prior contents of the RAM to the output port prior to writing the new data. "NO_CHANGE" - keeps the previous value on the output port and does not update the output port upon a write command. This is the suggested mode if not using the read data from a particular port of the RAM.
WRITE_MODE_B	String	"WRITE_FIRST", "READ_FIRST", "NO_CHANGE"	"WRITE_FIRST"	<p>Specifies the behavior of the DOB port upon a write command to the port.</p> <ul style="list-style-type: none"> "WRITE_FIRST" - the same port that is written to displays the contents of the written data to the outputs upon completion of the operation. "READ_FIRST" - displays the prior contents of the RAM to the output port prior to writing the new data. "NO_CHANGE" - keeps the previous value on the output port and does not update the output port upon a write command. This is the suggested mode if not using the read data from a particular port of the RAM.

For More Information

- See the [Spartan-3 Generation FPGA User Guide \(UG331\)](#).
- See the [Spartan-3E FPGA Family Data Sheet \(DS312\)](#).

RAMB16_S1_S2

Primitive: 16K-bit Data and 2K-bit Parity Dual-Port Synchronous Block RAM with 1-bit and 2-bit Ports

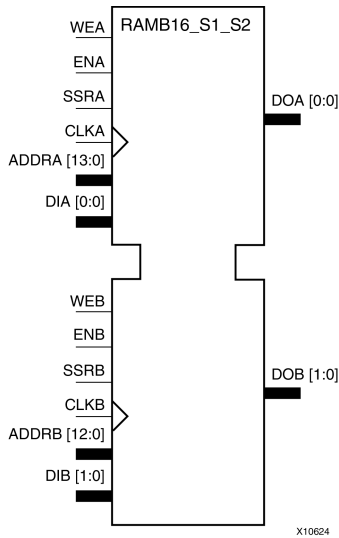

Introduction

This design element is a dual-ported dedicated random access memory block with synchronous write capability. Each block RAM port has 16384 bits of data memory. Ports configured as 9, 18, or 36 bits wide have an additional 2048 bits of parity memory. Each port is independent of the other while accessing the same set of 16384 data memory cells. Each port is independently configured to a specific data width. The possible port and cell configurations for this element are listed in the "Port Descriptions" section.

Logic Table

Truth Table A

Inputs								Outputs			
GSR	ENA	SSRA	WEA	CLKA	ADDRA	DIA	DIPA	DOA	DOPA	RAM Contents	
										Data RAM	Parity RAM
1	X	X	X	X	X	X	X	INIT_A	INIT_A	No Change	No Change
0	0	X	X	X	X	X	X	No Change	No Change	No Change	No Change
0	1	1	0	↑	X	X	X	SRVAL_A	SRVAL_A	No Change	No Change
0	1	1	1	↑	addr	data	pdata	SRVAL_A	SRVAL_A	RAM(addr) =>data	RAM(addr) =>pdata
0	1	0	0	↑	addr	X	X	RAM(addr)	RAM(addr)	No Change	No Change
0	1	0	1	↑	addr	data	pdata	No Change ¹ , RAM(addr) ² , data ³	No Change ¹ , RAM(addr) ² , pdata ³	RAM(addr) =>data	RAM(addr) =>pdata

GSR=Global Set Reset.

INIT_A=Value specified by the INIT_A attribute for output register. Default is all zeros.

SRVAL_A=register value.

addr=RAM address.

Inputs								Outputs		
GSR	ENA	SSRA	WEA	CLKA	ADDRA	DIA	DIPA	DOA	DOPA	RAM Contents
									Data RAM	Parity RAM
<p>RAM(addr)=RAM contents at address ADDR.</p> <p>data=RAM input data.</p> <p>pdata=RAM parity data.</p> <p>¹WRITE_MODE_A=NO_CHANGE.</p> <p>²WRITE_MODE_A=READ_FIRST.</p> <p>³WRITE_MODE_A=WRITE_FIRST.</p>										

Truth Table B

Inputs								Outputs			
GSR	ENB	SSRB	WEB	CLKB	ADDRB	DIB	DIPB	DOB	DOPB	RAM Contents	
										Data RAM	Parity RAM
1	X	X	X	X	X	X	X	INIT_B	INIT_B	No Change	No Change
0	0	X	X	X	X	X	X	No Change	No Change	No Change	No Change
0	1	1	0	↑	X	X	X	SRVAL_B	SRVAL_B	No Change	No Change
0	1	1	1	↑	addr	data	pdata	SRVAL_B	SRVAL_B	RAM(addr) =>data	RAM(addr) =>pdata
0	1	0	0	↑	addr	X	X	RAM(addr)	RAM(addr)	No Change	No Change
0	1	0	1	↑	addr	data	pdata	No Change ¹ , RAM(addr) ² , data ³	No Change ¹ , RAM(addr) ² , pdata ³	RAM(addr) =>data	RAM(addr) =>pdata

GSR=Global Set Reset.
 INIT_B=Value specified by the INIT_B attribute for output registers. Default is all zeros.
 SRVAL_B=register value.
 addr=RAM address.
 RAM(addr)=RAM contents at address ADDR.
 data=RAM input data.
 pdata=RAM parity data.
¹WRITE_MODE_B=NO_CHANGE.
²WRITE_MODE_B=READ_FIRST.
³WRITE_MODE_B=WRITE_FIRST.

Port Descriptions

Port A						Port B				
Design Element	Data Cells ¹	Parity Cells ¹	Address Bus	Data Bus	Parity Bus	Data Cells ¹	Parity Cells ¹	Address Bus	Data Bus	Parity Bus
RAMB16_S1_S2	16384 x 1	-	(13:0)	(0:0)	-	8192 x 2	-	(12:0)	(1:0)	-

¹Depth x Width

Each port is fully synchronous with independent clock pins. All Port A input pins have setup time referenced to the CLKA pin and its data output bus DOA has a clock-to-out time referenced to the CLKA. All Port B input pins have setup time referenced to the CLKB pin and its data output bus DOB has a clock-to-out time referenced to the CLKB. The enable ENA pin controls read, write, and reset for Port A. When ENA is Low, no data is written and the outputs (DOA and DOPA) retain the last state. When ENA is High and reset (SSRA) is High, DOA and DOPA are set to SRVAL_A during the Low-to-High clock (CLKA) transition; if write enable (WEA) is High, the memory contents reflect the data at DIA and DIPA. When ENA is High and WEA is Low, the data stored in the RAM address (ADDR_A) is read during the Low-to-High clock transition. By default, WRITE_MODE_A=WRITE_FIRST, when ENA and WEA are High, the data on the data inputs (DIA and DIPA) is loaded into the word selected by the write address (ADDR_A) during the Low-to-High clock transition and the data outputs (DOA and DOPA) reflect the selected (addressed) word.

The enable ENB pin controls read, write, and reset for Port B. When ENB is Low, no data is written and the outputs (DOB and DOPB) retain the last state. When ENB is High and reset (SSRB) is High, DOB and DOPB are set to SRVAL_B during the Low-to-High clock (CLKB) transition; if write enable (WEB) is High, the memory contents reflect the data at DIB and DIPB. When ENB is High and WEB is Low, the data stored in the RAM address (ADDRB) is read during the Low-to-High clock transition. By default, WRITE_MODE_B=WRITE_FIRST, when ENB and WEB are High, the data on the data inputs (DIB and PB) are loaded into the word selected by the write address (ADDRB) during the Low-to-High clock transition and the data outputs (DOB and DOPB) reflect the selected (addressed) word. The above descriptions assume active High control pins (ENA, WEA, SSRB, CLKA, ENB, WEB, SSRB, and CLKB). However, the active level can be changed by placing an inverter on the port. Any inverter placed on a RAMB16 port is absorbed into the block and does not use a CLB resource.

Address Mapping

Each port accesses the same set of 18432 memory cells using an addressing scheme that is dependent on the width of the port. For all port widths, 16384 memory cells are available for data as shown in the Port Address Mapping for Data table below. For 9-, 18-, and 36-bit wide ports, 2408 parity memory cells are also available as shown in Port Address Mapping for Parity table below. The physical RAM location that is addressed for a particular width is determined from the following formula.

$$\text{Start} = ((\text{ADDR port} + 1) * (\text{Widthport})) - 1$$

$$\text{End} = (\text{ADDRport}) * (\text{Widthport})$$

The following tables show address mapping for each port width.

Port Address Mapping for Data

Data Width	Port Data Addresses																																		
1	16384	<--	31	30	29	28	27	26	25	24	23	22	21	20	19	18	17	16	15	14	13	12	11	10	9	8	7	6	5	4	3	2	1	0	
2	8192	<--	15		14		13		12		11		10		9		8		7		6		5		4		3		2		1		0		
4	4096	<--	7				6				5				4				3				2				1				0				
8	2048	<--	3								2								1								0								
16	1024	<--	1																0																
32	512	<--	0																																

Port Address Mapping for Parity

Parity Width	Port Parity Addresses																																			
1	2048	<-----	3												2																				0	
2	1024	<-----	1																																	
4	512	<-----	0																																	

Initializing Memory Contents of a Dual-Port RAMB16

You can use the INIT_xx attributes to specify an initialization value for the memory contents of a RAMB16 during device configuration. The initialization of each RAMB16_Sm_Sn is set by 64 initialization attributes (INIT_00 through INIT_3F) of 64 hex values for a total of 16384 bits.

You can use the INITP_xx attributes to specify an initial value for the parity memory during device configuration or assertion. The initialization of the parity memory for ports configured for 9, 18, or 36 bits is set by 8 initialization attributes (INITP_00 through INITP_07) of 64 hex values for a total of 2048 bits.

If any INIT_xx or INITP_xx attribute is not specified, it is configured as zeros. Partial Strings are padded with zeros to the left.

Initializing the Output Register of a Dual-Port RAMB16

In Spartan-3A, each bit in an output register can be initialized at power on (when GSR is high) to either a 0 or 1. In addition, the initial state specified for power on can be different than the state that results from assertion of a set/reset. Four properties control initialization of the output register for a dual-port RAMB16: INIT_A, INIT_B, SRVAL_A, and SRVAL_B. The INIT_A attribute specifies the output register value at power on for Port A and the INIT_B attribute specifies the value for Port B. You can use the SRVAL_A attribute to define the state resulting from assertion of the SSR (set/reset) input on Port A. You can use the SRVAL_B attribute to define the state resulting from assertion of the SSR input on Port B.

The INIT_A, INIT_B, SRVAL_A, and SRVAL_B attributes specify the initialization value as a hexadecimal String. The value is dependent upon the port width. For example, for a RAMB16_S1_S4 with Port A width equal to 1 and Port B width equal to 4, the Port A output register contains 1 bit and the Port B output register contains 4 bits. Therefore, the INIT_A or SRVAL_A value can only be specified as a 1 or 0. For Port B, the output register contains 4 bits. In this case, you can use INIT_B or SRVAL_B to specify a hexadecimal value from 0 through F to initialize the 4 bits of the output register.

For those ports that include parity bits, the parity portion of the output register is specified in the high order bit position of the INIT_A, INIT_B, SRVAL_A, or SRVAL_B value.

The INIT and SRVAL attributes default to zero if they are not set by you.

Write Mode Selection

The WRITE_MODE_A attribute controls the memory and output contents of Port A for a dual-port RAMB16. The WRITE_MODE_B attribute does the same for Port B. By default, both WRITE_MODE_A and WRITE_MODE_B are set to WRITE_FIRST. This means that input is read, written to memory, and then passed to output. You can set the write mode for Port A and Port B to READ_FIRST to read the memory contents, pass the memory contents to the outputs, and then write the input to memory. Or, you can set the write mode to NO_CHANGE to have the input written to memory without changing the output. The Port A and Port B Conflict Resolution section describes how read/write conflicts are resolved when both Port A and Port B are attempting to read/write to the same memory cells.

Port A and Port B Conflict Resolution

Spartan-3A block SelectRAM is True Dual-Port RAM that allows both ports to simultaneously access the same memory cell. When one port writes to a given memory cell, the other port must not address that memory cell (for a write or a read) within the clock-to-clock setup window.

The following tables summarize the collision detection behavior of the dual-port RAMB16 based on the WRITE_MODE_A and WRITE_MODE_B settings.

WRITE_MODE_A=NO_CHANGE and WRITE_MODE_B=NO_CHANGE

WEA	WEB	CLKA	CLKB	DIA	DIB	DIPA	DIPB	DOA	DOB	DOPA	DOPB	Data RAM	Parity Ram
0	0	↑	↑	DIA	DIB	DIPA	DIPB	RAM	RAM	RAM	RAM	No Change	No Change
1	0	↑	↑	DIA	DIB	DIPA	DIPB	No Change	X	No Change	X	DIA	DIPA
0	1	↑	↑	DIA	DIB	DIPA	DIPB	X	No Change	X	No Change	DIB	DIPB
1	1	↑	↑	DIA	DIB	DIPA	DIPB	No Change	No Change	No Change	No Change	X	X

WRITE_MODE_A=READ_FIRST and WRITE_MODE_B=READ_FIRST

WEA	WEB	CLKA	CLKB	DIA	DIB	DIPA	DIPB	DOA	DOB	DOPA	DOPB	Data RAM	Parity Ram
0	0	↑	↑	DIA	DIB	DIPA	DIPB	RAM	RAM	RAM	RAM	No Change	No Change
1	0	↑	↑	DIA	DIB	DIPA	DIPB	RAM	RAM	RAM	RAM	DIA	DIPA

WEA	WEB	CLKA	CLKB	DIA	DIB	DIPA	DIPB	DOA	DOB	DOPA	DOPB	Data RAM	Parity Ram
0	1	↑	↑	DIA	DIB	DIPA	DIPB	RAM	RAM	RAM	RAM	DIB	DIPB
1	1	↑	↑	DIA	DIB	DIPA	DIPB	RAM	RAM	RAM	RAM	X	X

WRITE_MODE_A= WRITE_FIRST and WRITE_MODE_B=WRITE_FIRST

WEA	WEB	CLKA	CLKB	DIA	DIB	DIPA	DIPB	DOA	DOB	DOPA	DOPB	Data RAM	Parity Ram
0	0	↑	↑	DIA	DIB	DIPA	DIPB	RAM	RAM	RAM	RAM	No Change	No Change
1	0	↑	↑	DIA	DIB	DIPA	DIPB	DIA	X	DIPA	X	DIA	DIPA
0	1	↑	↑	DIA	DIB	DIPA	DIPB	X	DIB	X	DIPB	DIB	DIPB
1	1	↑	↑	DIA	DIB	DIPA	DIPB	X	X	X	X	X	X

WRITE_MODE_A=NO_CHANGE and WRITE_MODE_B=READ_FIRST

WEA	WEB	CLKA	CLKB	DIA	DIB	DIPA	DIPB	DOA	DOB	DOPA	DOPB	Data RAM	Parity Ram
0	0	↑	↑	DIA	DIB	DIPA	DIPB	RAM	RAM	RAM	RAM	No Change	No Change
1	0	↑	↑	DIA	DIB	DIPA	DIPB	No Change	X	No Change	X	DIA	DIPA
0	1	↑	↑	DIA	DIB	DIPA	DIPB	RAM	RAM	RAM	RAM	DIB	DIPB
1	1	↑	↑	DIA	DIB	DIPA	DIPB	No Change	X	No Change	X	DIB	DIPB

WRITE_MODE_A=NO_CHANGE and WRITE_MODE_B=WRITE_FIRST

WEA	WEB	CLKA	CLKB	DIA	DIB	DIPA	DIPB	DOA	DOB	DOPA	DOPB	Data RAM	Parity Ram
0	0	↑	↑	DIA	DIB	DIPA	DIPB	RAM	RAM	RAM	RAM	No Change	No Change
1	0	↑	↑	DIA	DIB	DIPA	DIPB	No Change	X	No Change	X	DIA	DIPA
0	1	↑	↑	DIA	DIB	DIPA	DIPB	X	DIB	X	DIPB	DIB	DIPB
1	1	↑	↑	DIA	DIB	DIPA	DIPB	No Change	X	No Change	X	X	X

WRITE_MODE_A=READ_FIRST and WRITE_MODE_B=WRITE_FIRST

WEA	WEB	CLKA	CLKB	DIA	DIB	DIPA	DIPB	DOA	DOB	DOPA	DOPB	Data RAM	Parity Ram
0	0	↑	↑	DIA	DIB	DIPA	DIPB	RAM	RAM	RAM	RAM	No Change	No Change
1	0	↑	↑	DIA	DIB	DIPA	DIPB	RAM	RAM	RAM	RAM	DIA	DIPA
0	1	↑	↑	DIA	DIB	DIPA	DIPB	X	DIB	X	DIPB	DIB	DIPB
1	1	↑	↑	DIA	DIB	DIPA	DIPB	X	DIB	X	DIPB	DIA	DIPA

Design Entry Method

This design element can be used in schematics.

Available Attributes

Attribute	Data Type	Allowed Values	Default	Description
INIT_00 to INIT_3F	Binary/ Hexadecimal	Any	All zeros	Specifies the initial contents of the data portion of the RAM array.
INIT_A	Binary/ Hexadecimal	Any	All zeros	Specifies the initial value of the DOA output port after completing configuration. For Type, the bit width is dependent on the width of the A port of the RAM.
INIT_B	Binary/ Hexadecimal	Any	All zeros	Specifies the initial value of the DOB output port after completing configuration. For Type, the bit width is dependent on the width of the B port of the RAM.
INITP_00 to INITP_07	Binary/ Hexadecimal	Any	All zeros	Specifies the initial contents of the parity portion of the RAM array.
SIM_COLLISION_CHECK	String	"ALL", "WARNING_ONLY", "GENERATE_X_ONLY", "NONE"	"ALL"	<p>Allows modification of the simulation behavior if a memory collision occurs. The output is affected as follows:</p> <ul style="list-style-type: none"> "ALL" - Warning produced and affected outputs/memory location go unknown (X). "WARNING_ONLY" - Warning produced and affected outputs/memory retain last value. "GENERATE_X_ONLY" - No warning. However, affected outputs/memory go unknown (X). "NONE" - No warning and affected outputs/memory retain last value. <p>Note Setting this to a value other than "ALL" can allow problems in the design go unnoticed during simulation. Care should be taken when changing the value of this attribute. Please see the <i>Synthesis and Simulation Design Guide</i> for more information.</p>
SRVAL_A	Binary/ Hexadecimal	Any	All zeros	Sets on a per-bit basis whether the DOA output port sets (goes to a one) or resets (goes to a zero) upon the assertion of the RSTA pin. For Type, the bit width is dependent on the width of the A port of the RAM. Default is all bits reset.
SRVAL_B	Binary/ Hexadecimal	Any	All zeros	Sets on a per-bit basis whether the DOB output port sets (goes to a one) or resets (goes to a zero) upon the assertion of the RSTB pin. For Type, the bit width is dependent on the width of the B port of the RAM. Default is all bits reset.

Attribute	Data Type	Allowed Values	Default	Description
WRITE_MODE_A	String	"WRITE_FIRST", "READ_FIRST", "NO_CHANGE"	"WRITE_FIRST"	<p>Specifies the behavior of the DOA port upon a write command to the port.</p> <ul style="list-style-type: none"> "WRITE_FIRST" - the same port that is written to displays the contents of the written data to the outputs upon completion of the operation. "READ_FIRST" - displays the prior contents of the RAM to the output port prior to writing the new data. "NO_CHANGE" - keeps the previous value on the output port and does not update the output port upon a write command. This is the suggested mode if not using the read data from a particular port of the RAM.
WRITE_MODE_B	String	"WRITE_FIRST", "READ_FIRST", "NO_CHANGE"	"WRITE_FIRST"	<p>Specifies the behavior of the DOB port upon a write command to the port.</p> <ul style="list-style-type: none"> "WRITE_FIRST" - the same port that is written to displays the contents of the written data to the outputs upon completion of the operation. "READ_FIRST" - displays the prior contents of the RAM to the output port prior to writing the new data. "NO_CHANGE" - keeps the previous value on the output port and does not update the output port upon a write command. This is the suggested mode if not using the read data from a particular port of the RAM.

For More Information

- See the [Spartan-3 Generation FPGA User Guide \(UG331\)](#).
- See the [Spartan-3E FPGA Family Data Sheet \(DS312\)](#).

RAMB16_S1_S36

Primitive: 16K-bit Data and 2K-bit Parity Dual-Port Synchronous Block RAM with 1-bit and 36-bit Ports

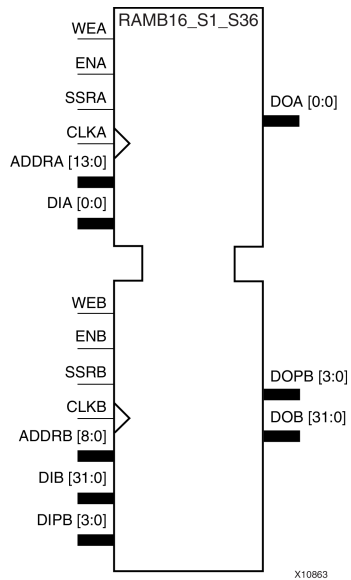

Introduction

This design element is a dual-ported dedicated random access memory block with synchronous write capability. Each block RAM port has 16384 bits of data memory. Ports configured as 9, 18, or 36 bits wide have an additional 2048 bits of parity memory. Each port is independent of the other while accessing the same set of 16384 data memory cells. Each port is independently configured to a specific data width. The possible port and cell configurations for this element are listed in the "Port Descriptions" section.

Logic Table

Truth Table A

Inputs								Outputs			
GSR	ENA	SSRA	WEA	CLKA	ADDR	DIA	DIPA	DOA	DOPA	RAM Contents	
										Data RAM	Parity RAM
1	X	X	X	X	X	X	X	INIT_A	INIT_A	No Change	No Change
0	0	X	X	X	X	X	X	No Change	No Change	No Change	No Change
0	1	1	0	↑	X	X	X	SRVAL_A	SRVAL_A	No Change	No Change
0	1	1	1	↑	addr	data	pdata	SRVAL_A	SRVAL_A	RAM(addr) =>data	RAM(addr) =>pdata
0	1	0	0	↑	addr	X	X	RAM(addr)	RAM(addr)	No Change	No Change
0	1	0	1	↑	addr	data	pdata	No Change ¹ , RAM(addr) ² , data ³	No Change ¹ , RAM(addr) ² , pdata ³	RAM(addr) =>data	RAM(addr) =>pdata

GSR=Global Set Reset.

INIT_A=Value specified by the INIT_A attribute for output register. Default is all zeros.

SRVAL_A=register value.

addr=RAM address.

RAM(addr)=RAM contents at address ADDR.

data=RAM input data.

pdata=RAM parity data.

¹WRITE_MODE_A=NO_CHANGE.

²WRITE_MODE_A=READ_FIRST.

³WRITE_MODE_A=WRITE_FIRST.

Truth Table B

Inputs								Outputs			
GSR	ENB	SSRB	WEB	CLKB	ADDRB	DIB	DIPB	DOB	DOPB	RAM Contents	
										Data RAM	Parity RAM
1	X	X	X	X	X	X	X	INIT_B	INIT_B	No Change	No Change
0	0	X	X	X	X	X	X	No Change	No Change	No Change	No Change
0	1	1	0	↑	X	X	X	SRVAL_B	SRVAL_B	No Change	No Change
0	1	1	1	↑	addr	data	pdata	SRVAL_B	SRVAL_B	RAM(addr) =>data	RAM(addr) =>pdata
0	1	0	0	↑	addr	X	X	RAM(addr)	RAM(addr)	No Change	No Change
0	1	0	1	↑	addr	data	pdata	No Change ¹ , RAM(addr) ² , data ³	No Change ¹ , RAM(addr) ² , pdata ³	RAM(addr) =>data	RAM(addr) =>pdata

GSR=Global Set Reset.
 INIT_B=Value specified by the INIT_B attribute for output registers. Default is all zeros.
 SRVAL_B=register value.
 addr=RAM address.
 RAM(addr)=RAM contents at address ADDR.
 data=RAM input data.
 pdata=RAM parity data.
¹WRITE_MODE_B=NO_CHANGE.
²WRITE_MODE_B=READ_FIRST.
³WRITE_MODE_B=WRITE_FIRST.

Port Descriptions

Port A						Port B				
Design Element	Data Cells ¹	Parity Cells ¹	Address Bus	Data Bus	Parity Bus	Data Cells ¹	Parity Cells ¹	Address Bus	Data Bus	Parity Bus
RAMB16_S1_S36	16384 x 1	-	(13:0)	(0:0)	-	512 x 32	512 x 4	(8:0)	(31:0)	(3:0)

¹Depth x Width

Each port is fully synchronous with independent clock pins. All Port A input pins have setup time referenced to the CLKA pin and its data output bus DOA has a clock-to-out time referenced to the CLKA. All Port B input pins have setup time referenced to the CLKB pin and its data output bus DOB has a clock-to-out time referenced to the CLKB. The enable ENA pin controls read, write, and reset for Port A. When ENA is Low, no data is written and the outputs (DOA and DOPA) retain the last state. When ENA is High and reset (SSRA) is High, DOA and DOPA are set to SRVAL_A during the Low-to-High clock (CLKA) transition; if write enable (WEA) is High, the memory contents reflect the data at DIA and DIPA. When ENA is High and WEA is Low, the data stored in the RAM address (ADDR_A) is read during the Low-to-High clock transition. By default, WRITE_MODE_A=WRITE_FIRST, when ENA and WEA are High, the data on the data inputs (DIA and DIPA) is loaded into the word selected by the write address (ADDR_A) during the Low-to-High clock transition and the data outputs (DOA and DOPA) reflect the selected (addressed) word.

The enable ENB pin controls read, write, and reset for Port B. When ENB is Low, no data is written and the outputs (DOB and DOPB) retain the last state. When ENB is High and reset (SSRB) is High, DOB and DOPB are set to SRVAL_B during the Low-to-High clock (CLKB) transition; if write enable (WEB) is High, the memory contents reflect the data at DIB and DIPB. When ENB is High and WEB is Low, the data stored in the RAM address (ADDRB) is read during the Low-to-High clock transition. By default, WRITE_MODE_B=WRITE_FIRST, when ENB and WEB are High, the data on the data inputs (DIB and PB) are loaded into the word selected by the write address (ADDRB) during the Low-to-High clock transition and the data outputs (DOB and DOPB) reflect the selected (addressed) word. The above descriptions assume active High control pins (ENA, WEA, SSRA, CLKA, ENB, WEB, SSRB, and CLKB). However, the active level can be changed by placing an inverter on the port. Any inverter placed on a RAMB16 port is absorbed into the block and does not use a CLB resource.

Address Mapping

Each port accesses the same set of 18432 memory cells using an addressing scheme that is dependent on the width of the port. For all port widths, 16384 memory cells are available for data as shown in the Port Address Mapping for Data table below. For 9-, 18-, and 36-bit wide ports, 2408 parity memory cells are also available as shown in Port Address Mapping for Parity table below. The physical RAM location that is addressed for a particular width is determined from the following formula.

$$\text{Start} = ((\text{ADDR port} + 1) * (\text{Widthport})) - 1$$

$$\text{End} = (\text{ADDRport}) * (\text{Widthport})$$

The following tables show address mapping for each port width.

Port Address Mapping for Data

Data Width	Port Data Addresses																																		
1	16384	<--	31	30	29	28	27	26	25	24	23	22	21	20	19	18	17	16	15	14	13	12	11	10	9	8	7	6	5	4	3	2	1	0	
2	8192	<--	15		14		13		12		11		10		9		8		7		6		5		4		3		2		1		0		
4	4096	<--	7				6				5				4				3				2				1				0				
8	2048	<--	3								2								1								0								
16	1024	<--	1																0																
32	512	<--	0																																

Port Address Mapping for Parity

Parity Width	Port Parity Addresses																																			
1	2048	<----	3							2					1																			0		
2	1024	<----	1												0																					
4	512	<----	0																																	

Initializing Memory Contents of a Dual-Port RAMB16

You can use the INIT_xx attributes to specify an initialization value for the memory contents of a RAMB16 during device configuration. The initialization of each RAMB16_Sm_Sn is set by 64 initialization attributes (INIT_00 through INIT_3F) of 64 hex values for a total of 16384 bits.

You can use the INITP_xx attributes to specify an initial value for the parity memory during device configuration or assertion. The initialization of the parity memory for ports configured for 9, 18, or 36 bits is set by 8 initialization attributes (INITP_00 through INITP_07) of 64 hex values for a total of 2048 bits.

If any INIT_xx or INITP_xx attribute is not specified, it is configured as zeros. Partial Strings are padded with zeros to the left.

Initializing the Output Register of a Dual-Port RAMB16

In Spartan®-3A and above devices, each bit in an output register can be initialized at power on (when GSR is high) to either a 0 or 1. In addition, the initial state specified for power on can be different than the state that results from assertion of a set/reset. Four properties control initialization of the output register for a dual-port RAMB16: INIT_A, INIT_B, SRVAL_A, and SRVAL_B. The INIT_A attribute specifies the output register value at power on for Port A and the INIT_B attribute specifies the value for Port B. You can use the SRVAL_A attribute to define the state resulting from assertion of the SSR (set/reset) input on Port A. You can use the SRVAL_B attribute to define the state resulting from assertion of the SSR input on Port B.

The INIT_A, INIT_B, SRVAL_A, and SRVAL_B attributes specify the initialization value as a hexadecimal String. The value is dependent upon the port width. For example, for a RAMB16_S1_S4 with Port A width equal to 1 and Port B width equal to 4, the Port A output register contains 1 bit and the Port B output register contains 4 bits. Therefore, the INIT_A or SRVAL_A value can only be specified as a 1 or 0. For Port B, the output register contains 4 bits. In this case, you can use INIT_B or SRVAL_B to specify a hexadecimal value from 0 through F to initialize the 4 bits of the output register.

For those ports that include parity bits, the parity portion of the output register is specified in the high order bit position of the INIT_A, INIT_B, SRVAL_A, or SRVAL_B value.

The INIT and SRVAL attributes default to zero if they are not set by you.

Write Mode Selection

The WRITE_MODE_A attribute controls the memory and output contents of Port A for a dual-port RAMB16. The WRITE_MODE_B attribute does the same for Port B. By default, both WRITE_MODE_A and WRITE_MODE_B are set to WRITE_FIRST. This means that input is read, written to memory, and then passed to output. You can set the write mode for Port A and Port B to READ_FIRST to read the memory contents, pass the memory contents to the outputs, and then write the input to memory. Or, you can set the write mode to NO_CHANGE to have the input written to memory without changing the output. The Port A and Port B Conflict Resolution section describes how read/write conflicts are resolved when both Port A and Port B are attempting to read/write to the same memory cells.

Port A and Port B Conflict Resolution

Spartan-3A block SelectRAM™ is True Dual-Port RAM that allows both ports to simultaneously access the same memory cell. When one port writes to a given memory cell, the other port must not address that memory cell (for a write or a read) within the clock-to-clock setup window.

The following tables summarize the collision detection behavior of the dual-port RAMB16 based on the WRITE_MODE_A and WRITE_MODE_B settings.

WRITE_MODE_A=NO_CHANGE and WRITE_MODE_B=NO_CHANGE

WEA	WEB	CLKA	CLKB	DIA	DIB	DIPA	DIPB	DOA	DOB	DOPA	DOPB	Data RAM	Parity Ram
0	0	↑	↑	DIA	DIB	DIPA	DIPB	RAM	RAM	RAM	RAM	No Change	No Change
1	0	↑	↑	DIA	DIB	DIPA	DIPB	No Change	X	No Change	X	DIA	DIPA
0	1	↑	↑	DIA	DIB	DIPA	DIPB	X	No Change	X	No Change	DIB	DIPB
1	1	↑	↑	DIA	DIB	DIPA	DIPB	No Change	No Change	No Change	No Change	X	X

WRITE_MODE_A=READ_FIRST and WRITE_MODE_B=READ_FIRST

WEA	WEB	CLKA	CLKB	DIA	DIB	DIPA	DIPB	DOA	DOB	DOPA	DOPB	Data RAM	Parity Ram
0	0	↑	↑	DIA	DIB	DIPA	DIPB	RAM	RAM	RAM	RAM	No Change	No Change
1	0	↑	↑	DIA	DIB	DIPA	DIPB	RAM	RAM	RAM	RAM	DIA	DIPA
0	1	↑	↑	DIA	DIB	DIPA	DIPB	RAM	RAM	RAM	RAM	DIB	DIPB
1	1	↑	↑	DIA	DIB	DIPA	DIPB	RAM	RAM	RAM	RAM	X	X

WRITE_MODE_A= WRITE_FIRST and WRITE_MODE_B=WRITE_FIRST

WEA	WEB	CLKA	CLKB	DIA	DIB	DIPA	DIPB	DOA	DOB	DOPA	DOPB	Data RAM	Parity Ram
0	0	↑	↑	DIA	DIB	DIPA	DIPB	RAM	RAM	RAM	RAM	No Change	No Change
1	0	↑	↑	DIA	DIB	DIPA	DIPB	DIA	X	DIPA	X	DIA	DIPA
0	1	↑	↑	DIA	DIB	DIPA	DIPB	X	DIB	X	DIPB	DIB	DIPB
1	1	↑	↑	DIA	DIB	DIPA	DIPB	X	X	X	X	X	X

WRITE_MODE_A=NO_CHANGE and WRITE_MODE_B=READ_FIRST

WEA	WEB	CLKA	CLKB	DIA	DIB	DIPA	DIPB	DOA	DOB	DOPA	DOPB	Data RAM	Parity Ram
0	0	↑	↑	DIA	DIB	DIPA	DIPB	RAM	RAM	RAM	RAM	No Change	No Change
1	0	↑	↑	DIA	DIB	DIPA	DIPB	No Change	X	No Change	X	DIA	DIPA
0	1	↑	↑	DIA	DIB	DIPA	DIPB	RAM	RAM	RAM	RAM	DIB	DIPB
1	1	↑	↑	DIA	DIB	DIPA	DIPB	No Change	X	No Change	X	DIB	DIPB

WRITE_MODE_A=NO_CHANGE and WRITE_MODE_B=WRITE_FIRST

WEA	WEB	CLKA	CLKB	DIA	DIB	DIPA	DIPB	DOA	DOB	DOPA	DOPB	Data RAM	Parity Ram
0	0	↑	↑	DIA	DIB	DIPA	DIPB	RAM	RAM	RAM	RAM	No Change	No Change
1	0	↑	↑	DIA	DIB	DIPA	DIPB	No Change	X	No Change	X	DIA	DIPA
0	1	↑	↑	DIA	DIB	DIPA	DIPB	X	DIB	X	DIPB	DIB	DIPB
1	1	↑	↑	DIA	DIB	DIPA	DIPB	No Change	X	No Change	X	X	X

WRITE_MODE_A=READ_FIRST and WRITE_MODE_B=WRITE_FIRST

WEA	WEB	CLKA	CLKB	DIA	DIB	DIPA	DIPB	DOA	DOB	DOPA	DOPB	Data RAM	Parity Ram
0	0	↑	↑	DIA	DIB	DIPA	DIPB	RAM	RAM	RAM	RAM	No Change	No Change
1	0	↑	↑	DIA	DIB	DIPA	DIPB	RAM	RAM	RAM	RAM	DIA	DIPA

WEA	WEB	CLKA	CLKB	DIA	DIB	DIPA	DIPB	DOA	DOB	DOPA	DOPB	Data RAM	Parity Ram
0	1	↑	↑	DIA	DIB	DIPA	DIPB	X	DIB	X	DIPB	DIB	DIPB
1	1	↑	↑	DIA	DIB	DIPA	DIPB	X	DIB	X	DIPB	DIA	DIPA

Design Entry Method

This design element can be used in schematics.

Available Attributes

Attribute	Data Type	Allowed Values	Default	Description
INIT_00 to INIT_3F	Binary/Hexadecimal	Any	All zeros	Specifies the initial contents of the data portion of the RAM array.
INIT_A	Binary/Hexadecimal	Any	All zeros	Specifies the initial value of the DOA output port after completing configuration. For Type, the bit width is dependent on the width of the A port of the RAM.
INIT_B	Binary/Hexadecimal	Any	All zeros	Specifies the initial value of the DOB output port after completing configuration. For Type, the bit width is dependent on the width of the B port of the RAM.
INITP_00 to INITP_07	Binary/Hexadecimal	Any	All zeros	Specifies the initial contents of the parity portion of the RAM array.
SIM_COLLISION_CHECK	String	"ALL", "WARNING_ONLY", "GENERATE_X_ONLY", "NONE"	"ALL"	<p>Allows modification of the simulation behavior if a memory collision occurs. The output is affected as follows:</p> <ul style="list-style-type: none"> "ALL" - Warning produced and affected outputs/memory location go unknown (X). "WARNING_ONLY" - Warning produced and affected outputs/memory retain last value. "GENERATE_X_ONLY" - No warning. However, affected outputs/memory go unknown (X). "NONE" - No warning and affected outputs/memory retain last value. <p>Note Setting this to a value other than "ALL" can allow problems in the design go unnoticed during simulation. Care should be taken when changing the value of this attribute. Please see the <i>Synthesis and Simulation Design Guide</i> for more information.</p>
SRVAL_A	Binary/Hexadecimal	Any	All zeros	Sets on a per-bit basis whether the DOA output port sets (goes to a one) or resets (goes to a zero) upon the assertion of the RSTA pin. For Type, the bit width is dependent on the width of the A port of the RAM. Default is all bits reset.
SRVAL_B	Binary/Hexadecimal	Any	All zeros	Sets on a per-bit basis whether the DOB output port sets (goes to a one) or resets (goes to a zero) upon the assertion of the RSTB pin. For Type, the bit width is dependent on the width of the B port of the RAM. Default is all bits reset.

Attribute	Data Type	Allowed Values	Default	Description
WRITE_MODE_A	String	"WRITE_FIRST", "READ_FIRST", "NO_CHANGE"	"WRITE_FIRST"	<p>Specifies the behavior of the DOA port upon a write command to the port.</p> <ul style="list-style-type: none"> "WRITE_FIRST" - the same port that is written to displays the contents of the written data to the outputs upon completion of the operation. "READ_FIRST" - displays the prior contents of the RAM to the output port prior to writing the new data. "NO_CHANGE" - keeps the previous value on the output port and does not update the output port upon a write command. This is the suggested mode if not using the read data from a particular port of the RAM.
WRITE_MODE_B	String	"WRITE_FIRST", "READ_FIRST", "NO_CHANGE"	"WRITE_FIRST"	<p>Specifies the behavior of the DOB port upon a write command to the port.</p> <ul style="list-style-type: none"> "WRITE_FIRST" - the same port that is written to displays the contents of the written data to the outputs upon completion of the operation. "READ_FIRST" - displays the prior contents of the RAM to the output port prior to writing the new data. "NO_CHANGE" - keeps the previous value on the output port and does not update the output port upon a write command. This is the suggested mode if not using the read data from a particular port of the RAM.

For More Information

- See the [Spartan-3 Generation FPGA User Guide \(UG331\)](#).
- See the [Spartan-3E FPGA Family Data Sheet \(DS312\)](#).

RAMB16_S1_S4

Primitive: 16K-bit Data and 2K-bit Parity Dual-Port Synchronous Block RAM with 1-bit and 4-bit Ports

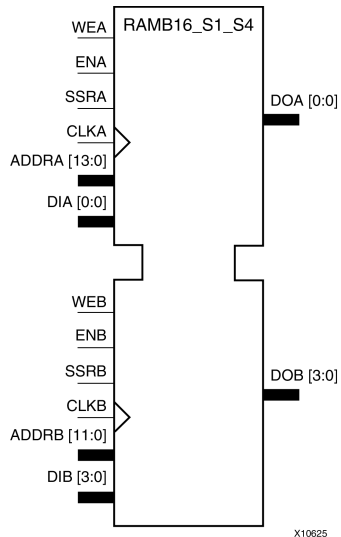

Introduction

This design element is a dual-ported dedicated random access memory block with synchronous write capability. Each block RAM port has 16384 bits of data memory. Ports configured as 9, 18, or 36 bits wide have an additional 2048 bits of parity memory. Each port is independent of the other while accessing the same set of 16384 data memory cells. Each port is independently configured to a specific data width. The possible port and cell configurations for this element are listed in the "Port Descriptions" section.

Logic Table

Truth Table A

Inputs								Outputs			
GSR	ENA	SSRA	WEA	CLKA	ADDRA	DIA	DIPA	DOA	DOPA	RAM Contents	
										Data RAM	Parity RAM
1	X	X	X	X	X	X	X	INIT_A	INIT_A	No Change	No Change
0	0	X	X	X	X	X	X	No Change	No Change	No Change	No Change
0	1	1	0	↑	X	X	X	SRVAL_A	SRVAL_A	No Change	No Change
0	1	1	1	↑	addr	data	pdata	SRVAL_A	SRVAL_A	RAM(addr) =>data	RAM(addr) =>pdata
0	1	0	0	↑	addr	X	X	RAM(addr)	RAM(addr)	No Change	No Change
0	1	0	1	↑	addr	data	pdata	No Change ¹ , RAM(addr) ² , data ³	No Change ¹ , RAM(addr) ² , pdata ³	RAM(addr) =>data	RAM(addr) =>pdata

GSR=Global Set Reset.

INIT_A=Value specified by the INIT_A attribute for output register. Default is all zeros.

SRVAL_A=register value.

addr=RAM address.

RAM(addr)=RAM contents at address ADDR.

data=RAM input data.

pdata=RAM parity data.

¹WRITE_MODE_A=NO_CHANGE.

²WRITE_MODE_A=READ_FIRST.

³WRITE_MODE_A=WRITE_FIRST.

Truth Table B

Inputs								Outputs			
GSR	ENB	SSRB	WEB	CLKB	ADDRB	DIB	DIPB	DOB	DOPB	RAM Contents	
										Data RAM	Parity RAM
1	X	X	X	X	X	X	X	INIT_B	INIT_B	No Change	No Change
0	0	X	X	X	X	X	X	No Change	No Change	No Change	No Change
0	1	1	0	↑	X	X	X	SRVAL_B	SRVAL_B	No Change	No Change
0	1	1	1	↑	addr	data	pdata	SRVAL_B	SRVAL_B	RAM(addr) =>data	RAM(addr) =>pdata
0	1	0	0	↑	addr	X	X	RAM(addr)	RAM(addr)	No Change	No Change
0	1	0	1	↑	addr	data	pdata	No Change ¹ , RAM(addr) ² , data ³	No Change ¹ , RAM(addr) ² , pdata ³	RAM(addr) =>data	RAM(addr) =>pdata

GSR=Global Set Reset.
 INIT_B=Value specified by the INIT_B attribute for output registers. Default is all zeros.
 SRVAL_B=register value.
 addr=RAM address.
 RAM(addr)=RAM contents at address ADDR.
 data=RAM input data.
 pdata=RAM parity data.
¹WRITE_MODE_B=NO_CHANGE.
²WRITE_MODE_B=READ_FIRST.
³WRITE_MODE_B=WRITE_FIRST.

Port Descriptions

Port A						Port B				
Design Element	Data Cells ¹	Parity Cells ¹	Address Bus	Data Bus	Parity Bus	Data Cells ¹	Parity Cells ¹	Address Bus	Data Bus	Parity Bus
RAMB16_S1_S4	16384 x 1	-	(13:0)	(0:0)	-	4096 x 4	-	(11:0)	(3:0)	-

¹Depth x Width

Each port is fully synchronous with independent clock pins. All Port A input pins have setup time referenced to the CLKA pin and its data output bus DOA has a clock-to-out time referenced to the CLKA. All Port B input pins have setup time referenced to the CLKB pin and its data output bus DOB has a clock-to-out time referenced to the CLKB. The enable ENA pin controls read, write, and reset for Port A. When ENA is Low, no data is written and the outputs (DOA and DOPA) retain the last state. When ENA is High and reset (SSRA) is High, DOA and DOPA are set to SRVAL_A during the Low-to-High clock (CLKA) transition; if write enable (WEA) is High, the memory contents reflect the data at DIA and DIPA. When ENA is High and WEA is Low, the data stored in the RAM address (ADDR_A) is read during the Low-to-High clock transition. By default, WRITE_MODE_A=WRITE_FIRST, when ENA and WEA are High, the data on the data inputs (DIA and DIPA) is loaded into the word selected by the write address (ADDR_A) during the Low-to-High clock transition and the data outputs (DOA and DOPA) reflect the selected (addressed) word.

Initializing the Output Register of a Dual-Port RAMB16

In Spartan®-3A and above devices, each bit in an output register can be initialized at power on (when GSR is high) to either a 0 or 1. In addition, the initial state specified for power on can be different than the state that results from assertion of a set/reset. Four properties control initialization of the output register for a dual-port RAMB16: INIT_A, INIT_B, SRVAL_A, and SRVAL_B. The INIT_A attribute specifies the output register value at power on for Port A and the INIT_B attribute specifies the value for Port B. You can use the SRVAL_A attribute to define the state resulting from assertion of the SSR (set/reset) input on Port A. You can use the SRVAL_B attribute to define the state resulting from assertion of the SSR input on Port B.

The INIT_A, INIT_B, SRVAL_A, and SRVAL_B attributes specify the initialization value as a hexadecimal String. The value is dependent upon the port width. For example, for a RAMB16_S1_S4 with Port A width equal to 1 and Port B width equal to 4, the Port A output register contains 1 bit and the Port B output register contains 4 bits. Therefore, the INIT_A or SRVAL_A value can only be specified as a 1 or 0. For Port B, the output register contains 4 bits. In this case, you can use INIT_B or SRVAL_B to specify a hexadecimal value from 0 through F to initialize the 4 bits of the output register.

For those ports that include parity bits, the parity portion of the output register is specified in the high order bit position of the INIT_A, INIT_B, SRVAL_A, or SRVAL_B value.

The INIT and SRVAL attributes default to zero if they are not set by you.

Write Mode Selection

The WRITE_MODE_A attribute controls the memory and output contents of Port A for a dual-port RAMB16. The WRITE_MODE_B attribute does the same for Port B. By default, both WRITE_MODE_A and WRITE_MODE_B are set to WRITE_FIRST. This means that input is read, written to memory, and then passed to output. You can set the write mode for Port A and Port B to READ_FIRST to read the memory contents, pass the memory contents to the outputs, and then write the input to memory. Or, you can set the write mode to NO_CHANGE to have the input written to memory without changing the output. The Port A and Port B Conflict Resolution section describes how read/write conflicts are resolved when both Port A and Port B are attempting to read/write to the same memory cells.

Port A and Port B Conflict Resolution

Spartan-3A block SelectRAM™ is True Dual-Port RAM that allows both ports to simultaneously access the same memory cell. When one port writes to a given memory cell, the other port must not address that memory cell (for a write or a read) within the clock-to-clock setup window.

The following tables summarize the collision detection behavior of the dual-port RAMB16 based on the WRITE_MODE_A and WRITE_MODE_B settings.

WRITE_MODE_A=NO_CHANGE and WRITE_MODE_B=NO_CHANGE

WEA	WEB	CLKA	CLKB	DIA	DIB	DIPA	DIPB	DOA	DOB	DOPA	DOPB	Data RAM	Parity Ram
0	0	↑	↑	DIA	DIB	DIPA	DIPB	RAM	RAM	RAM	RAM	No Change	No Change
1	0	↑	↑	DIA	DIB	DIPA	DIPB	No Change	X	No Change	X	DIA	DIPA
0	1	↑	↑	DIA	DIB	DIPA	DIPB	X	No Change	X	No Change	DIB	DIPB
1	1	↑	↑	DIA	DIB	DIPA	DIPB	No Change	No Change	No Change	No Change	X	X

WRITE_MODE_A=READ_FIRST and WRITE_MODE_B=READ_FIRST

WEA	WEB	CLKA	CLKB	DIA	DIB	DIPA	DIPB	DOA	DOB	DOPA	DOPB	Data RAM	Parity Ram
0	0	↑	↑	DIA	DIB	DIPA	DIPB	RAM	RAM	RAM	RAM	No Change	No Change
1	0	↑	↑	DIA	DIB	DIPA	DIPB	RAM	RAM	RAM	RAM	DIA	DIPA
0	1	↑	↑	DIA	DIB	DIPA	DIPB	RAM	RAM	RAM	RAM	DIB	DIPB
1	1	↑	↑	DIA	DIB	DIPA	DIPB	RAM	RAM	RAM	RAM	X	X

WRITE_MODE_A= WRITE_FIRST and WRITE_MODE_B=WRITE_FIRST

WEA	WEB	CLKA	CLKB	DIA	DIB	DIPA	DIPB	DOA	DOB	DOPA	DOPB	Data RAM	Parity Ram
0	0	↑	↑	DIA	DIB	DIPA	DIPB	RAM	RAM	RAM	RAM	No Change	No Change
1	0	↑	↑	DIA	DIB	DIPA	DIPB	DIA	X	DIPA	X	DIA	DIPA
0	1	↑	↑	DIA	DIB	DIPA	DIPB	X	DIB	X	DIPB	DIB	DIPB
1	1	↑	↑	DIA	DIB	DIPA	DIPB	X	X	X	X	X	X

WRITE_MODE_A=NO_CHANGE and WRITE_MODE_B=READ_FIRST

WEA	WEB	CLKA	CLKB	DIA	DIB	DIPA	DIPB	DOA	DOB	DOPA	DOPB	Data RAM	Parity Ram
0	0	↑	↑	DIA	DIB	DIPA	DIPB	RAM	RAM	RAM	RAM	No Change	No Change
1	0	↑	↑	DIA	DIB	DIPA	DIPB	No Change	X	No Change	X	DIA	DIPA
0	1	↑	↑	DIA	DIB	DIPA	DIPB	RAM	RAM	RAM	RAM	DIB	DIPB
1	1	↑	↑	DIA	DIB	DIPA	DIPB	No Change	X	No Change	X	DIB	DIPB

WRITE_MODE_A=NO_CHANGE and WRITE_MODE_B=WRITE_FIRST

WEA	WEB	CLKA	CLKB	DIA	DIB	DIPA	DIPB	DOA	DOB	DOPA	DOPB	Data RAM	Parity Ram
0	0	↑	↑	DIA	DIB	DIPA	DIPB	RAM	RAM	RAM	RAM	No Change	No Change
1	0	↑	↑	DIA	DIB	DIPA	DIPB	No Change	X	No Change	X	DIA	DIPA
0	1	↑	↑	DIA	DIB	DIPA	DIPB	X	DIB	X	DIPB	DIB	DIPB
1	1	↑	↑	DIA	DIB	DIPA	DIPB	No Change	X	No Change	X	X	X

WRITE_MODE_A=READ_FIRST and WRITE_MODE_B=WRITE_FIRST

WEA	WEB	CLKA	CLKB	DIA	DIB	DIPA	DIPB	DOA	DOB	DOPA	DOPB	Data RAM	Parity Ram
0	0	↑	↑	DIA	DIB	DIPA	DIPB	RAM	RAM	RAM	RAM	No Change	No Change
1	0	↑	↑	DIA	DIB	DIPA	DIPB	RAM	RAM	RAM	RAM	DIA	DIPA

WEA	WEB	CLKA	CLKB	DIA	DIB	DIPA	DIPB	DOA	DOB	DOPA	DOPB	Data RAM	Parity Ram
0	1	↑	↑	DIA	DIB	DIPA	DIPB	X	DIB	X	DIPB	DIB	DIPB
1	1	↑	↑	DIA	DIB	DIPA	DIPB	X	DIB	X	DIPB	DIA	DIPA

Design Entry Method

This design element can be used in schematics.

Available Attributes

Attribute	Data Type	Allowed Values	Default	Description
INIT_00 to INIT_3F	Binary/Hexadecimal	Any	All zeros	Specifies the initial contents of the data portion of the RAM array.
INIT_A	Binary/Hexadecimal	Any	All zeros	Specifies the initial value of the DOA output port after completing configuration. For Type, the bit width is dependent on the width of the A port of the RAM.
INIT_B	Binary/Hexadecimal	Any	All zeros	Specifies the initial value of the DOB output port after completing configuration. For Type, the bit width is dependent on the width of the B port of the RAM.
INITP_00 to INITP_07	Binary/Hexadecimal	Any	All zeros	Specifies the initial contents of the parity portion of the RAM array.
SIM_COLLISION_CHECK	String	"ALL", "WARNING_ONLY", "GENERATE_X_ONLY", "NONE"	"ALL"	<p>Allows modification of the simulation behavior if a memory collision occurs. The output is affected as follows:</p> <ul style="list-style-type: none"> "ALL" - Warning produced and affected outputs/memory location go unknown (X). "WARNING_ONLY" - Warning produced and affected outputs/memory retain last value. "GENERATE_X_ONLY" - No warning. However, affected outputs/memory go unknown (X). "NONE" - No warning and affected outputs/memory retain last value. <p>Note Setting this to a value other than "ALL" can allow problems in the design go unnoticed during simulation. Care should be taken when changing the value of this attribute. Please see the <i>Synthesis and Simulation Design Guide</i> for more information.</p>
SRVAL_A	Binary/Hexadecimal	Any	All zeros	Sets on a per-bit basis whether the DOA output port sets (goes to a one) or resets (goes to a zero) upon the assertion of the RSTA pin. For Type, the bit width is dependent on the width of the A port of the RAM. Default is all bits reset.
SRVAL_B	Binary/Hexadecimal	Any	All zeros	Sets on a per-bit basis whether the DOB output port sets (goes to a one) or resets (goes to a zero) upon the assertion of the RSTB pin. For Type, the bit width is dependent on the width of the B port of the RAM. Default is all bits reset.

Attribute	Data Type	Allowed Values	Default	Description
WRITE_MODE_A	String	"WRITE_FIRST", "READ_FIRST", "NO_CHANGE"	"WRITE_FIRST"	<p>Specifies the behavior of the DOA port upon a write command to the port.</p> <ul style="list-style-type: none"> "WRITE_FIRST" - the same port that is written to displays the contents of the written data to the outputs upon completion of the operation. "READ_FIRST" - displays the prior contents of the RAM to the output port prior to writing the new data. "NO_CHANGE" - keeps the previous value on the output port and does not update the output port upon a write command. This is the suggested mode if not using the read data from a particular port of the RAM.
WRITE_MODE_B	String	"WRITE_FIRST", "READ_FIRST", "NO_CHANGE"	"WRITE_FIRST"	<p>Specifies the behavior of the DOB port upon a write command to the port.</p> <ul style="list-style-type: none"> "WRITE_FIRST" - the same port that is written to displays the contents of the written data to the outputs upon completion of the operation. "READ_FIRST" - displays the prior contents of the RAM to the output port prior to writing the new data. "NO_CHANGE" - keeps the previous value on the output port and does not update the output port upon a write command. This is the suggested mode if not using the read data from a particular port of the RAM.

For More Information

- See the [Spartan-3 Generation FPGA User Guide \(UG331\)](#).
- See the [Spartan-3E FPGA Family Data Sheet \(DS312\)](#).

RAMB16_S1_S9

Primitive: 16K-bit Data and 2K-bit Parity Dual-Port Synchronous Block RAM with 1-bit and 9-bit Ports

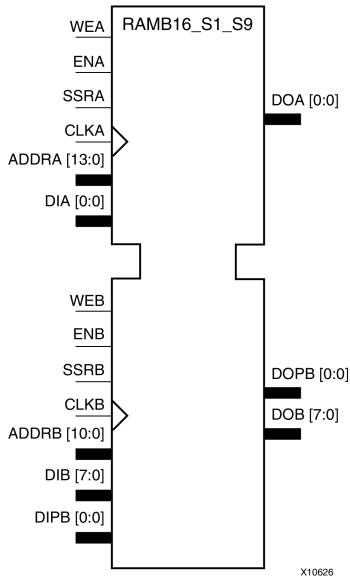

Introduction

This design element is a dual-ported dedicated random access memory block with synchronous write capability. Each block RAM port has 16384 bits of data memory. Ports configured as 9, 18, or 36 bits wide have an additional 2048 bits of parity memory. Each port is independent of the other while accessing the same set of 16384 data memory cells. Each port is independently configured to a specific data width. The possible port and cell configurations for this element are listed in the "Port Descriptions" section.

Logic Table

Truth Table A

Inputs								Outputs			
GSR	ENA	SSRA	WEA	CLKA	ADDRA	DIA	DIPA	DOA	DOPA	RAM Contents	
										Data RAM	Parity RAM
1	X	X	X	X	X	X	X	INIT_A	INIT_A	No Change	No Change
0	0	X	X	X	X	X	X	No Change	No Change	No Change	No Change
0	1	1	0	↑	X	X	X	SRVAL_A	SRVAL_A	No Change	No Change
0	1	1	1	↑	addr	data	pdata	SRVAL_A	SRVAL_A	RAM(addr) =>data	RAM(addr) =>pdata
0	1	0	0	↑	addr	X	X	RAM(addr)	RAM(addr)	No Change	No Change
0	1	0	1	↑	addr	data	pdata	No Change ¹ , RAM(addr) ² , data ³	No Change ¹ , RAM(addr) ² , pdata ³	RAM(addr) =>data	RAM(addr) =>pdata

GSR=Global Set Reset.

INIT_A=Value specified by the INIT_A attribute for output register. Default is all zeros.

SRVAL_A=register value.

addr=RAM address.

RAM(addr)=RAM contents at address ADDR.

data=RAM input data.

pdata=RAM parity data.

¹WRITE_MODE_A=NO_CHANGE.

²WRITE_MODE_A=READ_FIRST.

³WRITE_MODE_A=WRITE_FIRST.

Truth Table B

Inputs								Outputs			
GSR	ENB	SSRB	WEB	CLKB	ADDRB	DIB	DIPB	DOB	DOPB	RAM Contents	
										Data RAM	Parity RAM
1	X	X	X	X	X	X	X	INIT_B	INIT_B	No Change	No Change
0	0	X	X	X	X	X	X	No Change	No Change	No Change	No Change
0	1	1	0	↑	X	X	X	SRVAL_B	SRVAL_B	No Change	No Change
0	1	1	1	↑	addr	data	pdata	SRVAL_B	SRVAL_B	RAM(addr) =>data	RAM(addr) =>pdata
0	1	0	0	↑	addr	X	X	RAM(addr)	RAM(addr)	No Change	No Change
0	1	0	1	↑	addr	data	pdata	No Change ¹ , RAM(addr) ² , data ³	No Change ¹ , RAM(addr) ² , pdata ³	RAM(addr) =>data	RAM(addr) =>pdata

GSR=Global Set Reset.
 INIT_B=Value specified by the INIT_B attribute for output registers. Default is all zeros.
 SRVAL_B=register value.
 addr=RAM address.
 RAM(addr)=RAM contents at address ADDR.
 data=RAM input data.
 pdata=RAM parity data.
¹WRITE_MODE_B=NO_CHANGE.
²WRITE_MODE_B=READ_FIRST.
³WRITE_MODE_B=WRITE_FIRST.

Port Descriptions

Port A						Port B				
Design Element	Data Cells ¹	Parity Cells ¹	Address Bus	Data Bus	Parity Bus	Data Cells ¹	Parity Cells ¹	Address Bus	Data Bus	Parity Bus
RAMB16_S1_S9	16384 x 1	-	(13:0)	(0:0)	-	2048 x 8	2048 x 1	(10:0)	(7:0)	(0:0)

¹Depth x Width

Each port is fully synchronous with independent clock pins. All Port A input pins have setup time referenced to the CLKA pin and its data output bus DOA has a clock-to-out time referenced to the CLKA. All Port B input pins have setup time referenced to the CLKB pin and its data output bus DOB has a clock-to-out time referenced to the CLKB. The enable ENA pin controls read, write, and reset for Port A. When ENA is Low, no data is written and the outputs (DOA and DOPA) retain the last state. When ENA is High and reset (SSRA) is High, DOA and DOPA are set to SRVAL_A during the Low-to-High clock (CLKA) transition; if write enable (WEA) is High, the memory contents reflect the data at DIA and DIPB. When ENA is High and WEA is Low, the data stored in the RAM address (ADDRB) is read during the Low-to-High clock transition. By default, WRITE_MODE_A=WRITE_FIRST, when ENA and WEA are High, the data on the data inputs (DIA and DIPB) is loaded into the word selected by the write address (ADDRB) during the Low-to-High clock transition and the data outputs (DOA and DOPA) reflect the selected (addressed) word.

In Spartan®-3A, each bit in an output register can be initialized at power on (when GSR is high) to either a 0 or 1. In addition, the initial state specified for power on can be different than the state that results from assertion of a set/reset. Four properties control initialization of the output register for a dual-port RAMB16: INIT_A, INIT_B, SRVAL_A, and SRVAL_B. The INIT_A attribute specifies the output register value at power on for Port A and the INIT_B attribute specifies the value for Port B. You can use the SRVAL_A attribute to define the state resulting from assertion of the SSR (set/reset) input on Port A. You can use the SRVAL_B attribute to define the state resulting from assertion of the SSR input on Port B.

The INIT_A, INIT_B, SRVAL_A, and SRVAL_B attributes specify the initialization value as a hexadecimal String. The value is dependent upon the port width. For example, for a RAMB16_S1_S4 with Port A width equal to 1 and Port B width equal to 4, the Port A output register contains 1 bit and the Port B output register contains 4 bits. Therefore, the INIT_A or SRVAL_A value can only be specified as a 1 or 0. For Port B, the output register contains 4 bits. In this case, you can use INIT_B or SRVAL_B to specify a hexadecimal value from 0 through F to initialize the 4 bits of the output register.

For those ports that include parity bits, the parity portion of the output register is specified in the high order bit position of the INIT_A, INIT_B, SRVAL_A, or SRVAL_B value.

The INIT and SRVAL attributes default to zero if they are not set by you.

Write Mode Selection

The WRITE_MODE_A attribute controls the memory and output contents of Port A for a dual-port RAMB16. The WRITE_MODE_B attribute does the same for Port B. By default, both WRITE_MODE_A and WRITE_MODE_B are set to WRITE_FIRST. This means that input is read, written to memory, and then passed to output. You can set the write mode for Port A and Port B to READ_FIRST to read the memory contents, pass the memory contents to the outputs, and then write the input to memory. Or, you can set the write mode to NO_CHANGE to have the input written to memory without changing the output. The Port A and Port B Conflict Resolution section describes how read/write conflicts are resolved when both Port A and Port B are attempting to read/write to the same memory cells.

Port A and Port B Conflict Resolution

Spartan-3A block SelectRAM™ is True Dual-Port RAM that allows both ports to simultaneously access the same memory cell. When one port writes to a given memory cell, the other port must not address that memory cell (for a write or a read) within the clock-to-clock setup window.

The following tables summarize the collision detection behavior of the dual-port RAMB16 based on the WRITE_MODE_A and WRITE_MODE_B settings.

WRITE_MODE_A=NO_CHANGE and WRITE_MODE_B=NO_CHANGE

WEA	WEB	CLKA	CLKB	DIA	DIB	DIPA	DIPB	DOA	DOB	DOPA	DOPB	Data RAM	Parity Ram
0	0	↑	↑	DIA	DIB	DIPA	DIPB	RAM	RAM	RAM	RAM	No Change	No Change
1	0	↑	↑	DIA	DIB	DIPA	DIPB	No Change	X	No Change	X	DIA	DIPA
0	1	↑	↑	DIA	DIB	DIPA	DIPB	X	No Change	X	No Change	DIB	DIPB
1	1	↑	↑	DIA	DIB	DIPA	DIPB	No Change	No Change	No Change	No Change	X	X

WRITE_MODE_A=READ_FIRST and WRITE_MODE_B=READ_FIRST

WEA	WEB	CLKA	CLKB	DIA	DIB	DIPA	DIPB	DOA	DOB	DOPA	DOPB	Data RAM	Parity Ram
0	0	↑	↑	DIA	DIB	DIPA	DIPB	RAM	RAM	RAM	RAM	No Change	No Change
1	0	↑	↑	DIA	DIB	DIPA	DIPB	RAM	RAM	RAM	RAM	DIA	DIPA

WEA	WEB	CLKA	CLKB	DIA	DIB	DIPA	DIPB	DOA	DOB	DOPA	DOPB	Data RAM	Parity Ram
0	1	↑	↑	DIA	DIB	DIPA	DIPB	RAM	RAM	RAM	RAM	DIB	DIPB
1	1	↑	↑	DIA	DIB	DIPA	DIPB	RAM	RAM	RAM	RAM	X	X

WRITE_MODE_A= WRITE_FIRST and WRITE_MODE_B=WRITE_FIRST

WEA	WEB	CLKA	CLKB	DIA	DIB	DIPA	DIPB	DOA	DOB	DOPA	DOPB	Data RAM	Parity Ram
0	0	↑	↑	DIA	DIB	DIPA	DIPB	RAM	RAM	RAM	RAM	No Change	No Change
1	0	↑	↑	DIA	DIB	DIPA	DIPB	DIA	X	DIPA	X	DIA	DIPA
0	1	↑	↑	DIA	DIB	DIPA	DIPB	X	DIB	X	DIPB	DIB	DIPB
1	1	↑	↑	DIA	DIB	DIPA	DIPB	X	X	X	X	X	X

WRITE_MODE_A=NO_CHANGE and WRITE_MODE_B=READ_FIRST

WEA	WEB	CLKA	CLKB	DIA	DIB	DIPA	DIPB	DOA	DOB	DOPA	DOPB	Data RAM	Parity Ram
0	0	↑	↑	DIA	DIB	DIPA	DIPB	RAM	RAM	RAM	RAM	No Change	No Change
1	0	↑	↑	DIA	DIB	DIPA	DIPB	No Change	X	No Change	X	DIA	DIPA
0	1	↑	↑	DIA	DIB	DIPA	DIPB	RAM	RAM	RAM	RAM	DIB	DIPB
1	1	↑	↑	DIA	DIB	DIPA	DIPB	No Change	X	No Change	X	DIB	DIPB

WRITE_MODE_A=NO_CHANGE and WRITE_MODE_B=WRITE_FIRST

WEA	WEB	CLKA	CLKB	DIA	DIB	DIPA	DIPB	DOA	DOB	DOPA	DOPB	Data RAM	Parity Ram
0	0	↑	↑	DIA	DIB	DIPA	DIPB	RAM	RAM	RAM	RAM	No Change	No Change
1	0	↑	↑	DIA	DIB	DIPA	DIPB	No Change	X	No Change	X	DIA	DIPA
0	1	↑	↑	DIA	DIB	DIPA	DIPB	X	DIB	X	DIPB	DIB	DIPB
1	1	↑	↑	DIA	DIB	DIPA	DIPB	No Change	X	No Change	X	X	X

WRITE_MODE_A=READ_FIRST and WRITE_MODE_B=WRITE_FIRST

WEA	WEB	CLKA	CLKB	DIA	DIB	DIPA	DIPB	DOA	DOB	DOPA	DOPB	Data RAM	Parity Ram
0	0	↑	↑	DIA	DIB	DIPA	DIPB	RAM	RAM	RAM	RAM	No Change	No Change
1	0	↑	↑	DIA	DIB	DIPA	DIPB	RAM	RAM	RAM	RAM	DIA	DIPA
0	1	↑	↑	DIA	DIB	DIPA	DIPB	X	DIB	X	DIPB	DIB	DIPB
1	1	↑	↑	DIA	DIB	DIPA	DIPB	X	DIB	X	DIPB	DIA	DIPA

Design Entry Method

This design element can be used in schematics.

Available Attributes

Attribute	Data Type	Allowed Values	Default	Description
INIT_00 to INIT_3F	Binary/ Hexadecimal	Any	All zeros	Specifies the initial contents of the data portion of the RAM array.
INIT_A	Binary/ Hexadecimal	Any	All zeros	Specifies the initial value of the DOA output port after completing configuration. For Type, the bit width is dependent on the width of the A port of the RAM.
INIT_B	Binary/ Hexadecimal	Any	All zeros	Specifies the initial value of the DOB output port after completing configuration. For Type, the bit width is dependent on the width of the B port of the RAM.
INITP_00 to INITP_07	Binary/ Hexadecimal	Any	All zeros	Specifies the initial contents of the parity portion of the RAM array.
SIM_COLLISION_CHECK	String	"ALL", "WARNING_ONLY", "GENERATE_X_ONLY", "NONE"	"ALL"	<p>Allows modification of the simulation behavior if a memory collision occurs. The output is affected as follows:</p> <ul style="list-style-type: none"> "ALL" - Warning produced and affected outputs/memory location go unknown (X). "WARNING_ONLY" - Warning produced and affected outputs/memory retain last value. "GENERATE_X_ONLY" - No warning. However, affected outputs/memory go unknown (X). "NONE" - No warning and affected outputs/memory retain last value. <p>Note Setting this to a value other than "ALL" can allow problems in the design go unnoticed during simulation. Care should be taken when changing the value of this attribute. Please see the <i>Synthesis and Simulation Design Guide</i> for more information.</p>
SRVAL_A	Binary/ Hexadecimal	Any	All zeros	Sets on a per-bit basis whether the DOA output port sets (goes to a one) or resets (goes to a zero) upon the assertion of the RSTA pin. For Type, the bit width is dependent on the width of the A port of the RAM. Default is all bits reset.
SRVAL_B	Binary/ Hexadecimal	Any	All zeros	Sets on a per-bit basis whether the DOB output port sets (goes to a one) or resets (goes to a zero) upon the assertion of the RSTB pin. For Type, the bit width is dependent on the width of the B port of the RAM. Default is all bits reset.

Attribute	Data Type	Allowed Values	Default	Description
WRITE_MODE_A	String	"WRITE_FIRST", "READ_FIRST", "NO_CHANGE"	"WRITE_FIRST"	<p>Specifies the behavior of the DOA port upon a write command to the port.</p> <ul style="list-style-type: none"> "WRITE_FIRST" - the same port that is written to displays the contents of the written data to the outputs upon completion of the operation. "READ_FIRST" - displays the prior contents of the RAM to the output port prior to writing the new data. "NO_CHANGE" - keeps the previous value on the output port and does not update the output port upon a write command. This is the suggested mode if not using the read data from a particular port of the RAM.
WRITE_MODE_B	String	"WRITE_FIRST", "READ_FIRST", "NO_CHANGE"	"WRITE_FIRST"	<p>Specifies the behavior of the DOB port upon a write command to the port.</p> <ul style="list-style-type: none"> "WRITE_FIRST" - the same port that is written to displays the contents of the written data to the outputs upon completion of the operation. "READ_FIRST" - displays the prior contents of the RAM to the output port prior to writing the new data. "NO_CHANGE" - keeps the previous value on the output port and does not update the output port upon a write command. This is the suggested mode if not using the read data from a particular port of the RAM.

For More Information

- See the [Spartan-3 Generation FPGA User Guide \(UG331\)](#).
- See the [Spartan-3E FPGA Family Data Sheet \(DS312\)](#).

RAMB16_S18

Primitive: 16K-bit Data + 2K-bit Parity Memory, Single-Port Synchronous Block RAM with 18-bit Port

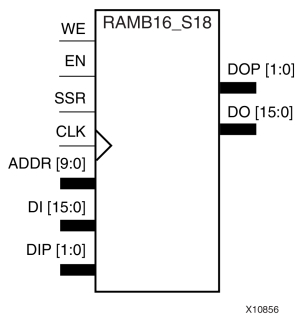

Introduction

This design element is a dedicated random access memory block with synchronous write capability. The block RAM port has 16384 bits of data memory. The cell configuration for this element is listed in the following table.

Data Cells		Parity Cells				
Depth	Width	Depth	Width	Address Bus	Data Bus	Parity Bus
1024	16	1024	2	(9:0)	(15:0)	(1:0)

The enable EN pin controls read, write, and reset. When EN is Low, no data is written and the outputs (DO and DOP) retain the last state. When EN is High and reset (SSR) is High, DO and DOP are set to SRVAL during the Low-to-High clock (CLK) transition; if write enable (WE) is High, the memory contents reflect the data at DI and DIP. When EN is High and WE is Low, the data stored in the RAM address (ADDR) is read during the Low-to-High clock transition. By default, WRITE_MODE=WRITE_FIRST, when EN and WE are High, the data on the data inputs (DI and DIP) is loaded into the word selected by the write address (ADDR) during the Low-to-High clock transition and the data outputs (DO and DOP) reflect the selected (addressed) word.

The above description assumes an active High EN, WE, SSR, and CLK. However, the active level can be changed by placing an inverter on the port. Any inverter placed on a RAMB16 port is absorbed into the block and does not use a CLB resource.

Logic Table

Inputs								Outputs			
GSR	EN	SSR	WE	CLK	ADDR	DI	DIP	DO	DOP	RAM Contents	
										Data RAM	Parity RAM
1	X	X	X	X	X	X	X	INIT	INIT	No Change	No Change
0	0	X	X	X	X	X	X	No Change	No Change	No Change	No Change
0	1	1	0	↑	X	X	X	SRVAL	SRVAL	No Change	No Change
0	1	1	1	↑	addr	data	pdata	SRVAL	SRVAL	RAM(addr) =>data	RAM(addr) =>pdata
0	1	0	0	↑	addr	X	X	RAM (addr)	RAM (addr)	No Change	No Change
0	1	0	1	↑	addr	data	pdata	No Change ¹ RAM	No Change ¹ RAM	RAM (addr)=>data	RAM (addr)=>pdata

Inputs								Outputs			
GSR	EN	SSR	WE	CLK	ADDR	DI	DIP	DO	DOP	RAM Contents	
										Data RAM	Parity RAM
								(addr) ² data ³	(addr) ² pdata ³		
<p>GSR=Global Set Reset signal</p> <p>INIT=Value specified by the INIT attribute for data memory. Default is all zeros.</p> <p>SRVAL=Value after assertion of SSR as specified by the SRVAL attribute.</p> <p>addr=RAM address.</p> <p>RAM(addr)=RAM contents at address ADDR.</p> <p>data=RAM input data.</p> <p>pdata=RAM parity data.</p> <p>¹WRITE_MODE=NO_CHANGE</p> <p>²WRITE_MODE=READ_FIRST</p> <p>³WRITE_MODE=WRITE_FIRST</p>											

Initialization

Initializing Memory Contents

You can use the INIT_xx attributes to specify an initialization value for the memory contents of a RAMB16 during device configuration. The initialization of each RAMB16 is set by 64 initialization attributes (INIT_00 through INIT_3F) of 64 hex values for a total of 16384 bits.

You can use the INITP_xx attributes to specify an initial value for the parity memory during device configuration or assertion. The initialization of the parity memory for ports configured for 9, 18, or 36 bits is set by 8 initialization attributes (INITP_00 through INITP_07) of 64 hex values for a total of 2048 bits.

Any INIT_xx or INITP_xx attribute that is not specified is configured as zeros. Partial Strings are padded with zeros to the left.

Initializing the Output Register

In Spartan®-3A and above devices, each bit in the output register can be initialized at power on to either a 0 or 1. In addition, the initial state specified for power on can be different than the state that results from assertion of a set/reset. Two types of properties control initialization of the output register for a single-port RAMB16: INIT and SRVAL. The INIT attribute specifies the output register value at power on. You can use the SRVAL attribute to define the state resulting from assertion of the SSR (set/reset) input.

The INIT and SRVAL attributes specify the initialization value as a hexadecimal String containing one bit for each bit in the output port. For example, for a RAMB16_S1 with port width equal to 1, the output register contains 1 bit. Therefore, the INIT or SRVAL value can only be specified as a 1 or 0. For RAMB16_S4 with port width equal to 4, the output register contains 4 bits. In this case, you can specify a hexadecimal value from 0 through F to initialize the 4 bits of the output register.

For those ports that include parity bits, the parity portion of the output register is specified in the high order bit position of the INIT or SRVAL value.

Selecting Write Mode

The WRITE_MODE attribute controls RAMB16 memory and output contents. By default, the WRITE_MODE is set to WRITE_FIRST. This means that input is read, written to memory, and then passed to output. You can set the WRITE_MODE to READ_FIRST to read the memory contents, pass the memory contents to the outputs, and then write the input to memory. Or, you can set the WRITE_MODE to NO_CHANGE to have the input written to memory without changing the output.

Design Entry Method

This design element can be used in schematics.

Available Attributes

Attribute	Data Type	Allowed Values	Default	Description
INIT	Binary/ Hexadecimal	Any Hex Value	All zeros	Identifies the initial value of the DO output port after completing configuration. The bit width is dependent on the width of the A or B port of the RAM.
INIT_00 to INIT_3F	Binary/ Hexadecimal	Any Hex Value	All zeros	Specifies the initial contents of the data portion of the RAM array.
INITP_00 to INITP_07	Binary/ Hexadecimal	Any Hex Value	All zeros	Specifies the initial contents of the parity portion of the RAM array.
SRVAL	Binary/ Hexadecimal	Any Hex Value	All zeros	Allows the individual selection of whether the DO output port sets (go to a one) or reset (go to a zero) upon the assertion of the SSR pin. The bit width is dependent on the width of the A or B port of the RAM.
WRITE_MODE	String	"WRITE_FIRST", "READ_FIRST" or "NO_CHANGE"	"WRITE_FIRST"	Specifies the behavior of the DO port upon a write command to the respected port. If set to "WRITE_FIRST", the same port that is written to displays the contents of the written data to the outputs upon completion of the operation. "READ_FIRST" displays the prior contents of the RAM to the output port prior to writing the new data. "NO_CHANGE" keeps the previous value on the output port and won't update the output port upon a write command. This is the suggested mode if not using the read data from a particular port of the RAM.

For More Information

- See the [Spartan-3 Generation FPGA User Guide \(UG331\)](#).
- See the [Spartan-3E FPGA Family Data Sheet \(DS312\)](#).

RAMB16_S18_S18

Primitive: 16K-bit Data and 2K-bit Parity Dual-Port Synchronous Block RAM with 18-bit Ports

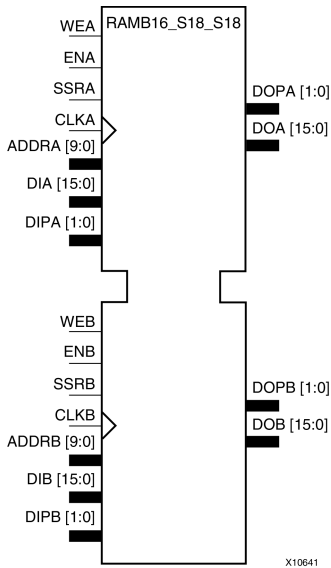

Introduction

This design element is a dual-ported dedicated random access memory block with synchronous write capability. Each block RAM port has 16384 bits of data memory. Ports configured as 9, 18, or 36 bits wide have an additional 2048 bits of parity memory. Each port is independent of the other while accessing the same set of 16384 data memory cells. Each port is independently configured to a specific data width. The possible port and cell configurations for this element are listed in the "Port Descriptions" section.

Logic Table

Truth Table A

Inputs								Outputs			
GSR	ENA	SSRA	WEA	CLKA	ADDR_A	DIA	DIPA	DOA	DOPA	RAM Contents	
										Data RAM	Parity RAM
1	X	X	X	X	X	X	X	INIT_A	INIT_A	No Change	No Change
0	0	X	X	X	X	X	X	No Change	No Change	No Change	No Change
0	1	1	0	↑	X	X	X	SRVAL_A	SRVAL_A	No Change	No Change
0	1	1	1	↑	addr	data	pdata	SRVAL_A	SRVAL_A	RAM(addr) =>data	RAM(addr) =>pdata
0	1	0	0	↑	addr	X	X	RAM(addr)	RAM(addr)	No Change	No Change
0	1	0	1	↑	addr	data	pdata	No Change ¹ , RAM(addr) ² , data ³	No Change ¹ , RAM(addr) ² , pdata ³	RAM(addr) =>data	RAM(addr) =>pdata

GSR=Global Set Reset.

INIT_A=Value specified by the INIT_A attribute for output register. Default is all zeros.

Inputs								Outputs				
GSR	ENA	SSRA	WEA	CLKA	ADDRA	DIA	DIPA	DOA	DOPA	RAM Contents		
											Data RAM	Parity RAM
<p>SRVAL_A=register value. addr=RAM address. RAM(addr)=RAM contents at address ADDR. data=RAM input data. pdata=RAM parity data. ¹WRITE_MODE_A=NO_CHANGE. ²WRITE_MODE_A=READ_FIRST. ³WRITE_MODE_A=WRITE_FIRST.</p>												

Truth Table B

Inputs								Outputs			
GSR	ENB	SSRB	WEB	CLKB	ADDRB	DIB	DIPB	DOB	DOPB	RAM Contents	
										Data RAM	Parity RAM
1	X	X	X	X	X	X	X	INIT_B	INIT_B	No Change	No Change
0	0	X	X	X	X	X	X	No Change	No Change	No Change	No Change
0	1	1	0	↑	X	X	X	SRVAL_B	SRVAL_B	No Change	No Change
0	1	1	1	↑	addr	data	pdata	SRVAL_B	SRVAL_B	RAM(addr) =>data	RAM(addr) =>pdata
0	1	0	0	↑	addr	X	X	RAM(addr)	RAM(addr)	No Change	No Change
0	1	0	1	↑	addr	data	pdata	No Change ¹ , RAM(addr) ² , data ³	No Change ¹ , RAM(addr) ² , pdata ³	RAM(addr) =>data	RAM(addr) =>pdata

GSR=Global Set Reset.

INIT_B=Value specified by the INIT_B attribute for output registers. Default is all zeros.

SRVAL_B=register value.

addr=RAM address.

RAM(addr)=RAM contents at address ADDR.

data=RAM input data.

pdata=RAM parity data.

¹WRITE_MODE_B=NO_CHANGE.

²WRITE_MODE_B=READ_FIRST.

³WRITE_MODE_B=WRITE_FIRST.

Port Descriptions

Port A						Port B				
Design Element	Data Cells ¹	Parity Cells ¹	Address Bus	Data Bus	Parity Bus	Data Cells ¹	Parity Cells ¹	Address Bus	Data Bus	Parity Bus
RAMB16_S18_S18	1024 x 16	1024 x 2	(9:0)	(15:0)	(1:0)	1024 x 16	1024 x 2	(9:0)	(15:0)	(1:0)

¹Depth x Width

Each port is fully synchronous with independent clock pins. All Port A input pins have setup time referenced to the CLKA pin and its data output bus DOA has a clock-to-out time referenced to the CLKA. All Port B input pins have setup time referenced to the CLKB pin and its data output bus DOB has a clock-to-out time referenced to the CLKB. The enable ENA pin controls read, write, and reset for Port A. When ENA is Low, no data is written and the outputs (DOA and DOPA) retain the last state. When ENA is High and reset (SSRA) is High, DOA and DOPA are set to SRVAL_A during the Low-to-High clock (CLKA) transition; if write enable (WEA) is High, the memory contents reflect the data at DIA and DIPA. When ENA is High and WEA is Low, the data stored in the RAM address (ADDR_A) is read during the Low-to-High clock transition. By default, WRITE_MODE_A=WRITE_FIRST, when ENA and WEA are High, the data on the data inputs (DIA and DIP_A) is loaded into the word selected by the write address (ADDR_A) during the Low-to-High clock transition and the data outputs (DOA and DOPA) reflect the selected (addressed) word.

The enable ENB pin controls read, write, and reset for Port B. When ENB is Low, no data is written and the outputs (DOB and DOPB) retain the last state. When ENB is High and reset (SSRB) is High, DOB and DOPB are set to SRVAL_B during the Low-to-High clock (CLKB) transition; if write enable (WEB) is High, the memory contents reflect the data at DIB and DIPB. When ENB is High and WEB is Low, the data stored in the RAM address (ADDRB) is read during the Low-to-High clock transition. By default, WRITE_MODE_B=WRITE_FIRST, when ENB and WEB are High, the data on the data inputs (DIB and PB) are loaded into the word selected by the write address (ADDRB) during the Low-to-High clock transition and the data outputs (DOB and DOPB) reflect the selected (addressed) word. The above descriptions assume active High control pins (ENA, WEA, SSRA, CLKA, ENB, WEB, SSRB, and CLKB). However, the active level can be changed by placing an inverter on the port. Any inverter placed on a RAMB16 port is absorbed into the block and does not use a CLB resource.

Address Mapping

Each port accesses the same set of 18432 memory cells using an addressing scheme that is dependent on the width of the port. For all port widths, 16384 memory cells are available for data as shown in the Port Address Mapping for Data table below. For 9-, 18-, and 36-bit wide ports, 2408 parity memory cells are also available as shown in Port Address Mapping for Parity table below. The physical RAM location that is addressed for a particular width is determined from the following formula.

$$\text{Start} = ((\text{ADDR port} + 1) * (\text{Widthport})) - 1$$

$$\text{End} = (\text{ADDRport}) * (\text{Widthport})$$

The following tables show address mapping for each port width.

Port Address Mapping for Data

Data Width	Port Data Addresses																																		
1	16384	<--	31	30	29	28	27	26	25	24	23	22	21	20	19	18	17	16	15	14	13	12	11	10	9	8	7	6	5	4	3	2	1	0	
2	8192	<--	15	14	13	12	11	10	9	8	7	6	5	4	3	2	1	0																	
4	4096	<--	7	6	5	4	3	2	1	0																									
8	2048	<--	3	2	1	0																													
16	1024	<--	1	0																															
32	512	<--	0																																

Port Address Mapping for Parity

Parity Width	Port Parity Addresses																																			
1	2048	<-----	3					2						1																					0	
2	1024	<-----	1											0																						
4	512	<-----	0																																	

Initializing Memory Contents of a Dual-Port RAMB16

You can use the INIT_xx attributes to specify an initialization value for the memory contents of a RAMB16 during device configuration. The initialization of each RAMB16_Sm_Sn is set by 64 initialization attributes (INIT_00 through INIT_3F) of 64 hex values for a total of 16384 bits.

You can use the INITP_xx attributes to specify an initial value for the parity memory during device configuration or assertion. The initialization of the parity memory for ports configured for 9, 18, or 36 bits is set by 8 initialization attributes (INITP_00 through INITP_07) of 64 hex values for a total of 2048 bits.

If any INIT_xx or INITP_xx attribute is not specified, it is configured as zeros. Partial Strings are padded with zeros to the left.

Initializing the Output Register of a Dual-Port RAMB16

In Spartan®-3A or above devices, each bit in an output register can be initialized at power on (when GSR is high) to either a 0 or 1. In addition, the initial state specified for power on can be different than the state that results from assertion of a set/reset. Four properties control initialization of the output register for a dual-port RAMB16: INIT_A, INIT_B, SRVAL_A, and SRVAL_B. The INIT_A attribute specifies the output register value at power on for Port A and the INIT_B attribute specifies the value for Port B. You can use the SRVAL_A attribute to define the state resulting from assertion of the SSR (set/reset) input on Port A. You can use the SRVAL_B attribute to define the state resulting from assertion of the SSR input on Port B.

The INIT_A, INIT_B, SRVAL_A, and SRVAL_B attributes specify the initialization value as a hexadecimal String. The value is dependent upon the port width. For example, for a RAMB16_S1_S4 with Port A width equal to 1 and Port B width equal to 4, the Port A output register contains 1 bit and the Port B output register contains 4 bits. Therefore, the INIT_A or SRVAL_A value can only be specified as a 1 or 0. For Port B, the output register contains 4 bits. In this case, you can use INIT_B or SRVAL_B to specify a hexadecimal value from 0 through F to initialize the 4 bits of the output register.

For those ports that include parity bits, the parity portion of the output register is specified in the high order bit position of the INIT_A, INIT_B, SRVAL_A, or SRVAL_B value.

The INIT and SRVAL attributes default to zero if they are not set by you.

Write Mode Selection

The WRITE_MODE_A attribute controls the memory and output contents of Port A for a dual-port RAMB16. The WRITE_MODE_B attribute does the same for Port B. By default, both WRITE_MODE_A and WRITE_MODE_B are set to WRITE_FIRST. This means that input is read, written to memory, and then passed to output. You can set the write mode for Port A and Port B to READ_FIRST to read the memory contents, pass the memory contents to the outputs, and then write the input to memory. Or, you can set the write mode to NO_CHANGE to have the input written to memory without changing the output. The Port A and Port B Conflict Resolution section describes how read/write conflicts are resolved when both Port A and Port B are attempting to read/write to the same memory cells.

Port A and Port B Conflict Resolution

Spartan-3A block SelectRAM™ is True Dual-Port RAM that allows both ports to simultaneously access the same memory cell. When one port writes to a given memory cell, the other port must not address that memory cell (for a write or a read) within the clock-to-clock setup window.

The following tables summarize the collision detection behavior of the dual-port RAMB16 based on the WRITE_MODE_A and WRITE_MODE_B settings.

WRITE_MODE_A=NO_CHANGE and WRITE_MODE_B=NO_CHANGE

WEA	WEB	CLKA	CLKB	DIA	DIB	DIPA	DIPB	DOA	DOB	DOPA	DOPB	Data RAM	Parity Ram
0	0	↑	↑	DIA	DIB	DIPA	DIPB	RAM	RAM	RAM	RAM	No Change	No Change
1	0	↑	↑	DIA	DIB	DIPA	DIPB	No Change	X	No Change	X	DIA	DIPA
0	1	↑	↑	DIA	DIB	DIPA	DIPB	X	No Change	X	No Change	DIB	DIPB
1	1	↑	↑	DIA	DIB	DIPA	DIPB	No Change	No Change	No Change	No Change	X	X

WRITE_MODE_A=READ_FIRST and WRITE_MODE_B=READ_FIRST

WEA	WEB	CLKA	CLKB	DIA	DIB	DIPA	DIPB	DOA	DOB	DOPA	DOPB	Data RAM	Parity Ram
0	0	↑	↑	DIA	DIB	DIPA	DIPB	RAM	RAM	RAM	RAM	No Change	No Change
1	0	↑	↑	DIA	DIB	DIPA	DIPB	RAM	RAM	RAM	RAM	DIA	DIPA
0	1	↑	↑	DIA	DIB	DIPA	DIPB	RAM	RAM	RAM	RAM	DIB	DIPB
1	1	↑	↑	DIA	DIB	DIPA	DIPB	RAM	RAM	RAM	RAM	X	X

WRITE_MODE_A= WRITE_FIRST and WRITE_MODE_B=WRITE_FIRST

WEA	WEB	CLKA	CLKB	DIA	DIB	DIPA	DIPB	DOA	DOB	DOPA	DOPB	Data RAM	Parity Ram
0	0	↑	↑	DIA	DIB	DIPA	DIPB	RAM	RAM	RAM	RAM	No Change	No Change
1	0	↑	↑	DIA	DIB	DIPA	DIPB	DIA	X	DIPA	X	DIA	DIPA
0	1	↑	↑	DIA	DIB	DIPA	DIPB	X	DIB	X	DIPB	DIB	DIPB
1	1	↑	↑	DIA	DIB	DIPA	DIPB	X	X	X	X	X	X

WRITE_MODE_A=NO_CHANGE and WRITE_MODE_B=READ_FIRST

WEA	WEB	CLKA	CLKB	DIA	DIB	DIPA	DIPB	DOA	DOB	DOPA	DOPB	Data RAM	Parity Ram
0	0	↑	↑	DIA	DIB	DIPA	DIPB	RAM	RAM	RAM	RAM	No Change	No Change
1	0	↑	↑	DIA	DIB	DIPA	DIPB	No Change	X	No Change	X	DIA	DIPA
0	1	↑	↑	DIA	DIB	DIPA	DIPB	RAM	RAM	RAM	RAM	DIB	DIPB
1	1	↑	↑	DIA	DIB	DIPA	DIPB	No Change	X	No Change	X	DIB	DIPB

WRITE_MODE_A=NO_CHANGE and WRITE_MODE_B=WRITE_FIRST

WEA	WEB	CLKA	CLKB	DIA	DIB	DIPA	DIPB	DOA	DOB	DOPA	DOPB	Data RAM	Parity Ram
0	0	↑	↑	DIA	DIB	DIPA	DIPB	RAM	RAM	RAM	RAM	No Change	No Change
1	0	↑	↑	DIA	DIB	DIPA	DIPB	No Change	X	No Change	X	DIA	DIPA
0	1	↑	↑	DIA	DIB	DIPA	DIPB	X	DIB	X	DIPB	DIB	DIPB
1	1	↑	↑	DIA	DIB	DIPA	DIPB	No Change	X	No Change	X	X	X

WRITE_MODE_A=READ_FIRST and WRITE_MODE_B=WRITE_FIRST

WEA	WEB	CLKA	CLKB	DIA	DIB	DIPA	DIPB	DOA	DOB	DOPA	DOPB	Data RAM	Parity Ram
0	0	↑	↑	DIA	DIB	DIPA	DIPB	RAM	RAM	RAM	RAM	No Change	No Change
1	0	↑	↑	DIA	DIB	DIPA	DIPB	RAM	RAM	RAM	RAM	DIA	DIPA

WEA	WEB	CLKA	CLKB	DIA	DIB	DIPA	DIPB	DOA	DOB	DOPA	DOPB	Data RAM	Parity Ram
0	1	↑	↑	DIA	DIB	DIPA	DIPB	X	DIB	X	DIPB	DIB	DIPB
1	1	↑	↑	DIA	DIB	DIPA	DIPB	X	DIB	X	DIPB	DIA	DIPA

Design Entry Method

This design element can be used in schematics.

Available Attributes

Attribute	Data Type	Allowed Values	Default	Description
INIT_00 to INIT_3F	Binary/ Hexadecimal	Any	All zeros	Specifies the initial contents of the data portion of the RAM array.
INIT_A	Binary/ Hexadecimal	Any	All zeros	Specifies the initial value of the DOA output port after completing configuration. For Type, the bit width is dependent on the width of the A port of the RAM.
INIT_B	Binary/ Hexadecimal	Any	All zeros	Specifies the initial value of the DOB output port after completing configuration. For Type, the bit width is dependent on the width of the B port of the RAM.
INITP_00 to INITP_07	Binary/ Hexadecimal	Any	All zeros	Specifies the initial contents of the parity portion of the RAM array.
SIM_COLLISION_CHECK	String	"ALL", "WARNING_ONLY", "GENERATE_X_ONLY", "NONE"	"ALL"	<p>Allows modification of the simulation behavior if a memory collision occurs. The output is affected as follows:</p> <ul style="list-style-type: none"> "ALL" - Warning produced and affected outputs/memory location go unknown (X). "WARNING_ONLY" - Warning produced and affected outputs/memory retain last value. "GENERATE_X_ONLY" - No warning. However, affected outputs/memory go unknown (X). "NONE" - No warning and affected outputs/memory retain last value. <p>Note Setting this to a value other than "ALL" can allow problems in the design go unnoticed during simulation. Care should be taken when changing the value of this attribute. Please see the <i>Synthesis and Simulation Design Guide</i> for more information.</p>
SRVAL_A	Binary/ Hexadecimal	Any	All zeros	Sets on a per-bit basis whether the DOA output port sets (goes to a one) or resets (goes to a zero) upon the assertion of the RSTA pin. For Type, the bit width is dependent on the width of the A port of the RAM. Default is all bits reset.
SRVAL_B	Binary/ Hexadecimal	Any	All zeros	Sets on a per-bit basis whether the DOB output port sets (goes to a one) or resets (goes to a zero) upon the assertion of the RSTB pin. For Type, the bit width is dependent on the width of the B port of the RAM. Default is all bits reset.

Attribute	Data Type	Allowed Values	Default	Description
WRITE_MODE_A	String	"WRITE_FIRST", "READ_FIRST", "NO_CHANGE"	"WRITE_FIRST"	<p>Specifies the behavior of the DOA port upon a write command to the port.</p> <ul style="list-style-type: none"> "WRITE_FIRST" - the same port that is written to displays the contents of the written data to the outputs upon completion of the operation. "READ_FIRST" - displays the prior contents of the RAM to the output port prior to writing the new data. "NO_CHANGE" - keeps the previous value on the output port and does not update the output port upon a write command. This is the suggested mode if not using the read data from a particular port of the RAM.
WRITE_MODE_B	String	"WRITE_FIRST", "READ_FIRST", "NO_CHANGE"	"WRITE_FIRST"	<p>Specifies the behavior of the DOB port upon a write command to the port.</p> <ul style="list-style-type: none"> "WRITE_FIRST" - the same port that is written to displays the contents of the written data to the outputs upon completion of the operation. "READ_FIRST" - displays the prior contents of the RAM to the output port prior to writing the new data. "NO_CHANGE" - keeps the previous value on the output port and does not update the output port upon a write command. This is the suggested mode if not using the read data from a particular port of the RAM.

For More Information

- See the [Spartan-3 Generation FPGA User Guide \(UG331\)](#).
- See the [Spartan-3E FPGA Family Data Sheet \(DS312\)](#).

RAMB16_S18_S36

Primitive: 16K-bit Data and 2K-bit Parity Dual-Port Synchronous Block RAM with 18-bit and 36-bit Ports

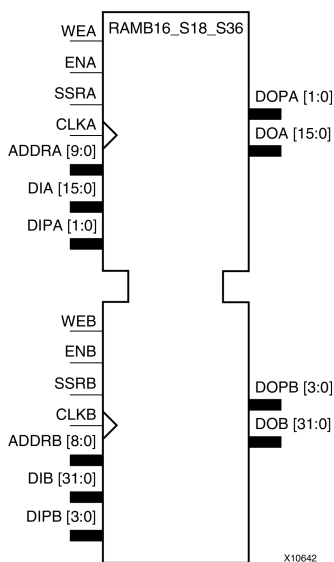

Introduction

This design element is a dual-ported dedicated random access memory block with synchronous write capability. Each block RAM port has 16384 bits of data memory. Ports configured as 9, 18, or 36 bits wide have an additional 2048 bits of parity memory. Each port is independent of the other while accessing the same set of 16384 data memory cells. Each port is independently configured to a specific data width. The possible port and cell configurations for this element are listed in the "Port Descriptions" section.

Logic Table

Truth Table A

Inputs								Outputs			
GSR	ENA	SSRA	WEA	CLKA	ADDRA	DIA	DIPA	DOA	DOPA	RAM Contents	
										Data RAM	Parity RAM
1	X	X	X	X	X	X	X	INIT_A	INIT_A	No Change	No Change
0	0	X	X	X	X	X	X	No Change	No Change	No Change	No Change
0	1	1	0	↑	X	X	X	SRVAL_A	SRVAL_A	No Change	No Change
0	1	1	1	↑	addr	data	pdata	SRVAL_A	SRVAL_A	RAM(addr) =>data	RAM(addr) =>pdata
0	1	0	0	↑	addr	X	X	RAM(addr)	RAM(addr)	No Change	No Change
0	1	0	1	↑	addr	data	pdata	No Change ¹ , RAM(addr) ² , data ³	No Change ¹ , RAM(addr) ² , pdata ³	RAM(addr) =>data	RAM(addr) =>pdata

GSR=Global Set Reset.

INIT_A=Value specified by the INIT_A attribute for output register. Default is all zeros.

SRVAL_A=register value.

Inputs								Outputs				
GSR	ENA	SSRA	WEA	CLKA	ADDRA	DIA	DIPA	DOA	DOPA	RAM Contents		
											Data RAM	Parity RAM
<p>addr=RAM address. RAM(addr)=RAM contents at address ADDR. data=RAM input data. pdata=RAM parity data. ¹WRITE_MODE_A=NO_CHANGE. ²WRITE_MODE_A=READ_FIRST. ³WRITE_MODE_A=WRITE_FIRST.</p>												

Truth Table B

Inputs								Outputs			
GSR	ENB	SSRB	WEB	CLKB	ADDRB	DIB	DIPB	DOB	DOPB	RAM Contents	
										Data RAM	Parity RAM
1	X	X	X	X	X	X	X	INIT_B	INIT_B	No Change	No Change
0	0	X	X	X	X	X	X	No Change	No Change	No Change	No Change
0	1	1	0	↑	X	X	X	SRVAL_B	SRVAL_B	No Change	No Change
0	1	1	1	↑	addr	data	pdata	SRVAL_B	SRVAL_B	RAM(addr) =>data	RAM(addr) =>pdata
0	1	0	0	↑	addr	X	X	RAM(addr)	RAM(addr)	No Change	No Change
0	1	0	1	↑	addr	data	pdata	No Change ¹ , RAM(addr) ² , data ³	No Change ¹ , RAM(addr) ² , pdata ³	RAM(addr) =>data	RAM(addr) =>pdata

GSR=Global Set Reset.

INIT_B=Value specified by the INIT_B attribute for output registers. Default is all zeros.

SRVAL_B=register value.

addr=RAM address.

RAM(addr)=RAM contents at address ADDR.

data=RAM input data.

pdata=RAM parity data.

¹WRITE_MODE_B=NO_CHANGE.

²WRITE_MODE_B=READ_FIRST.

³WRITE_MODE_B=WRITE_FIRST.

Port Descriptions

Port A						Port B				
Design Element	Data Cells ¹	Parity Cells ¹	Address Bus	Data Bus	Parity Bus	Data Cells ¹	Parity Cells ¹	Address Bus	Data Bus	Parity Bus
RAMB16_S18_S36	1024 x 16	1024 x 2	(9:0)	(15:0)	(1:0)	512 x 32	512 x 4	(8:0)	(31:0)	(3:0)

¹Depth x Width

Each port is fully synchronous with independent clock pins. All Port A input pins have setup time referenced to the CLKA pin and its data output bus DOA has a clock-to-out time referenced to the CLKA. All Port B input pins have setup time referenced to the CLKB pin and its data output bus DOB has a clock-to-out time referenced to the CLKB. The enable ENA pin controls read, write, and reset for Port A. When ENA is Low, no data is written and the outputs (DOA and DOPA) retain the last state. When ENA is High and reset (SSRA) is High, DOA and DOPA are set to SRVAL_A during the Low-to-High clock (CLKA) transition; if write enable (WEA) is High, the memory contents reflect the data at DIA and DIPA. When ENA is High and WEA is Low, the data stored in the RAM address (ADDR_A) is read during the Low-to-High clock transition. By default, WRITE_MODE_A=WRITE_FIRST, when ENA and WEA are High, the data on the data inputs (DIA and DIPA) is loaded into the word selected by the write address (ADDR_A) during the Low-to-High clock transition and the data outputs (DOA and DOPA) reflect the selected (addressed) word.

The enable ENB pin controls read, write, and reset for Port B. When ENB is Low, no data is written and the outputs (DOB and DOPB) retain the last state. When ENB is High and reset (SSRB) is High, DOB and DOPB are set to SRVAL_B during the Low-to-High clock (CLKB) transition; if write enable (WEB) is High, the memory contents reflect the data at DIB and DIPB. When ENB is High and WEB is Low, the data stored in the RAM address (ADDRB) is read during the Low-to-High clock transition. By default, WRITE_MODE_B=WRITE_FIRST, when ENB and WEB are High, the data on the data inputs (DIB and PB) are loaded into the word selected by the write address (ADDRB) during the Low-to-High clock transition and the data outputs (DOB and DOPB) reflect the selected (addressed) word. The above descriptions assume active High control pins (ENA, WEA, SSRA, CLKA, ENB, WEB, SSRB, and CLKB). However, the active level can be changed by placing an inverter on the port. Any inverter placed on a RAMB16 port is absorbed into the block and does not use a CLB resource.

Address Mapping

Each port accesses the same set of 18432 memory cells using an addressing scheme that is dependent on the width of the port. For all port widths, 16384 memory cells are available for data as shown in the Port Address Mapping for Data table below. For 9-, 18-, and 36-bit wide ports, 2408 parity memory cells are also available as shown in Port Address Mapping for Parity table below. The physical RAM location that is addressed for a particular width is determined from the following formula.

$$\text{Start} = ((\text{ADDR port} + 1) * (\text{Widthport})) - 1$$

$$\text{End} = (\text{ADDRport}) * (\text{Widthport})$$

The following tables shows address mapping for each port width.

Port Address Mapping for Data

Data Width	Port Data Addresses																																				
1	16384	<--	31	30	29	28	27	26	25	24	23	22	21	20	19	18	17	16	15	14	13	12	11	10	9	8	7	6	5	4	3	2	1	0			
2	8192	<--	15	14	13	12	11	10	9	8	7	6	5	4	3	2	1	0																			
4	4096	<--	7	6	5	4	3	2	1	0																											
8	2048	<--	3	2	1	0																															
16	1024	<--	1	0																																	
32	512	<--	0																																		

Port Address Mapping for Parity

Parity Width	Port Parity Addresses															
1	2048	<--	3	2	1	0										
2	1024	<--	1	0												
4	512	<--	0													

Initializing Memory Contents of a Dual-Port RAMB16

You can use the INIT_xx attributes to specify an initialization value for the memory contents of a RAMB16 during device configuration. The initialization of each RAMB16_Sm_Sn is set by 64 initialization attributes (INIT_00 through INIT_3F) of 64 hex values for a total of 16384 bits.

You can use the INITP_xx attributes to specify an initial value for the parity memory during device configuration or assertion. The initialization of the parity memory for ports configured for 9, 18, or 36 bits is set by 8 initialization attributes (INITP_00 through INITP_07) of 64 hex values for a total of 2048 bits.

If any INIT_xx or INITP_xx attribute is not specified, it is configured as zeros. Partial Strings are padded with zeros to the left.

Initializing the Output Register of a Dual-Port RAMB16

In Spartan®-3A and above devices, each bit in an output register can be initialized at power on (when GSR is high) to either a 0 or 1. In addition, the initial state specified for power on can be different than the state that results from assertion of a set/reset. Four properties control initialization of the output register for a dual-port RAMB16: INIT_A, INIT_B, SRVAL_A, and SRVAL_B. The INIT_A attribute specifies the output register value at power on for Port A and the INIT_B attribute specifies the value for Port B. You can use the SRVAL_A attribute to define the state resulting from assertion of the SSR (set/reset) input on Port A. You can use the SRVAL_B attribute to define the state resulting from assertion of the SSR input on Port B.

The INIT_A, INIT_B, SRVAL_A, and SRVAL_B attributes specify the initialization value as a hexadecimal String. The value is dependent upon the port width. For example, for a RAMB16_S1_S4 with Port A width equal to 1 and Port B width equal to 4, the Port A output register contains 1 bit and the Port B output register contains 4 bits. Therefore, the INIT_A or SRVAL_A value can only be specified as a 1 or 0. For Port B, the output register contains 4 bits. In this case, you can use INIT_B or SRVAL_B to specify a hexadecimal value from 0 through F to initialize the 4 bits of the output register.

For those ports that include parity bits, the parity portion of the output register is specified in the high order bit position of the INIT_A, INIT_B, SRVAL_A, or SRVAL_B value.

The INIT and SRVAL attributes default to zero if they are not set by you.

Write Mode Selection

The WRITE_MODE_A attribute controls the memory and output contents of Port A for a dual-port RAMB16. The WRITE_MODE_B attribute does the same for Port B. By default, both WRITE_MODE_A and WRITE_MODE_B are set to WRITE_FIRST. This means that input is read, written to memory, and then passed to output. You can set the write mode for Port A and Port B to READ_FIRST to read the memory contents, pass the memory contents to the outputs, and then write the input to memory. Or, you can set the write mode to NO_CHANGE to have the input written to memory without changing the output. The Port A and Port B Conflict Resolution section describes how read/write conflicts are resolved when both Port A and Port B are attempting to read/write to the same memory cells.

Port A and Port B Conflict Resolution

Spartan-3A block SelectRAM™ is True Dual-Port RAM that allows both ports to simultaneously access the same memory cell. When one port writes to a given memory cell, the other port must not address that memory cell (for a write or a read) within the clock-to-clock setup window.

The following tables summarize the collision detection behavior of the dual-port RAMB16 based on the WRITE_MODE_A and WRITE_MODE_B settings.

WRITE_MODE_A=NO_CHANGE and WRITE_MODE_B=NO_CHANGE

WEA	WEB	CLKA	CLKB	DIA	DIB	DIPA	DIPB	DOA	DOB	DOPA	DOPB	Data RAM	Parity Ram
0	0	↑	↑	DIA	DIB	DIPA	DIPB	RAM	RAM	RAM	RAM	No Change	No Change
1	0	↑	↑	DIA	DIB	DIPA	DIPB	No Change	X	No Change	X	DIA	DIPA
0	1	↑	↑	DIA	DIB	DIPA	DIPB	X	No Change	X	No Change	DIB	DIPB
1	1	↑	↑	DIA	DIB	DIPA	DIPB	No Change	No Change	No Change	No Change	X	X

WRITE_MODE_A=READ_FIRST and WRITE_MODE_B=READ_FIRST

WEA	WEB	CLKA	CLKB	DIA	DIB	DIPA	DIPB	DOA	DOB	DOPA	DOPB	Data RAM	Parity Ram
0	0	↑	↑	DIA	DIB	DIPA	DIPB	RAM	RAM	RAM	RAM	No Change	No Change
1	0	↑	↑	DIA	DIB	DIPA	DIPB	RAM	RAM	RAM	RAM	DIA	DIPA
0	1	↑	↑	DIA	DIB	DIPA	DIPB	RAM	RAM	RAM	RAM	DIB	DIPB
1	1	↑	↑	DIA	DIB	DIPA	DIPB	RAM	RAM	RAM	RAM	X	X

WRITE_MODE_A= WRITE_FIRST and WRITE_MODE_B=WRITE_FIRST

WEA	WEB	CLKA	CLKB	DIA	DIB	DIPA	DIPB	DOA	DOB	DOPA	DOPB	Data RAM	Parity Ram
0	0	↑	↑	DIA	DIB	DIPA	DIPB	RAM	RAM	RAM	RAM	No Change	No Change
1	0	↑	↑	DIA	DIB	DIPA	DIPB	DIA	X	DIPA	X	DIA	DIPA
0	1	↑	↑	DIA	DIB	DIPA	DIPB	X	DIB	X	DIPB	DIB	DIPB
1	1	↑	↑	DIA	DIB	DIPA	DIPB	X	X	X	X	X	X

WRITE_MODE_A=NO_CHANGE and WRITE_MODE_B=READ_FIRST

WEA	WEB	CLKA	CLKB	DIA	DIB	DIPA	DIPB	DOA	DOB	DOPA	DOPB	Data RAM	Parity Ram
0	0	↑	↑	DIA	DIB	DIPA	DIPB	RAM	RAM	RAM	RAM	No Change	No Change
1	0	↑	↑	DIA	DIB	DIPA	DIPB	No Change	X	No Change	X	DIA	DIPA
0	1	↑	↑	DIA	DIB	DIPA	DIPB	RAM	RAM	RAM	RAM	DIB	DIPB
1	1	↑	↑	DIA	DIB	DIPA	DIPB	No Change	X	No Change	X	DIB	DIPB

WRITE_MODE_A=NO_CHANGE and WRITE_MODE_B=WRITE_FIRST

WEA	WEB	CLKA	CLKB	DIA	DIB	DIPA	DIPB	DOA	DOB	DOPA	DOPB	Data RAM	Parity Ram
0	0	↑	↑	DIA	DIB	DIPA	DIPB	RAM	RAM	RAM	RAM	No Change	No Change
1	0	↑	↑	DIA	DIB	DIPA	DIPB	No Change	X	No Change	X	DIA	DIPA
0	1	↑	↑	DIA	DIB	DIPA	DIPB	X	DIB	X	DIPB	DIB	DIPB
1	1	↑	↑	DIA	DIB	DIPA	DIPB	No Change	X	No Change	X	X	X

WRITE_MODE_A=READ_FIRST and WRITE_MODE_B=WRITE_FIRST

WEA	WEB	CLKA	CLKB	DIA	DIB	DIPA	DIPB	DOA	DOB	DOPA	DOPB	Data RAM	Parity Ram
0	0	↑	↑	DIA	DIB	DIPA	DIPB	RAM	RAM	RAM	RAM	No Change	No Change
1	0	↑	↑	DIA	DIB	DIPA	DIPB	RAM	RAM	RAM	RAM	DIA	DIPA

WEA	WEB	CLKA	CLKB	DIA	DIB	DIPA	DIPB	DOA	DOB	DOPA	DOPB	Data RAM	Parity Ram
0	1	↑	↑	DIA	DIB	DIPA	DIPB	X	DIB	X	DIPB	DIB	DIPB
1	1	↑	↑	DIA	DIB	DIPA	DIPB	X	DIB	X	DIPB	DIA	DIPA

Design Entry Method

This design element can be used in schematics.

Available Attributes

Attribute	Data Type	Allowed Values	Default	Description
INIT_00 to INIT_3F	Binary/ Hexadecimal	Any	All zeros	Specifies the initial contents of the data portion of the RAM array.
INIT_A	Binary/ Hexadecimal	Any	All zeros	Specifies the initial value of the DOA output port after completing configuration. For Type, the bit width is dependent on the width of the A port of the RAM.
INIT_B	Binary/ Hexadecimal	Any	All zeros	Specifies the initial value of the DOB output port after completing configuration. For Type, the bit width is dependent on the width of the B port of the RAM.
INITP_00 to INITP_07	Binary/ Hexadecimal	Any	All zeros	Specifies the initial contents of the parity portion of the RAM array.
SIM_COLLISION_CHECK	String	"ALL", "WARNING_ONLY", "GENERATE_X_ONLY", "NONE"	"ALL"	<p>Allows modification of the simulation behavior if a memory collision occurs. The output is affected as follows:</p> <ul style="list-style-type: none"> "ALL" - Warning produced and affected outputs/memory location go unknown (X). "WARNING_ONLY" - Warning produced and affected outputs/memory retain last value. "GENERATE_X_ONLY" - No warning. However, affected outputs/memory go unknown (X). "NONE" - No warning and affected outputs/memory retain last value. <p>Note Setting this to a value other than "ALL" can allow problems in the design go unnoticed during simulation. Care should be taken when changing the value of this attribute. Please see the <i>Synthesis and Simulation Design Guide</i> for more information.</p>
SRVAL_A	Binary/ Hexadecimal	Any	All zeros	Sets on a per-bit basis whether the DOA output port sets (goes to a one) or resets (goes to a zero) upon the assertion of the RSTA pin. For Type, the bit width is dependent on the width of the A port of the RAM. Default is all bits reset.
SRVAL_B	Binary/ Hexadecimal	Any	All zeros	Sets on a per-bit basis whether the DOB output port sets (goes to a one) or resets (goes to a zero) upon the assertion of the RSTB pin. For Type, the bit width is dependent on the width of the B port of the RAM. Default is all bits reset.

Attribute	Data Type	Allowed Values	Default	Description
WRITE_MODE_A	String	"WRITE_FIRST", "READ_FIRST", "NO_CHANGE"	"WRITE_FIRST"	<p>Specifies the behavior of the DOA port upon a write command to the port.</p> <ul style="list-style-type: none"> "WRITE_FIRST" - the same port that is written to displays the contents of the written data to the outputs upon completion of the operation. "READ_FIRST" - displays the prior contents of the RAM to the output port prior to writing the new data. "NO_CHANGE" - keeps the previous value on the output port and does not update the output port upon a write command. This is the suggested mode if not using the read data from a particular port of the RAM.
WRITE_MODE_B	String	"WRITE_FIRST", "READ_FIRST", "NO_CHANGE"	"WRITE_FIRST"	<p>Specifies the behavior of the DOB port upon a write command to the port.</p> <ul style="list-style-type: none"> "WRITE_FIRST" - the same port that is written to displays the contents of the written data to the outputs upon completion of the operation. "READ_FIRST" - displays the prior contents of the RAM to the output port prior to writing the new data. "NO_CHANGE" - keeps the previous value on the output port and does not update the output port upon a write command. This is the suggested mode if not using the read data from a particular port of the RAM.

For More Information

- See the [Spartan-3 Generation FPGA User Guide \(UG331\)](#).
- See the [Spartan-3E FPGA Family Data Sheet \(DS312\)](#).

RAMB16_S2

Primitive: 16K-bit Data and 2K-bit Parity Single-Port Synchronous Block RAM with 2-bit Port

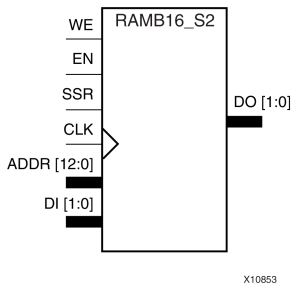

Introduction

This design element is a dedicated random access memory block with synchronous write capability. The block RAM port has 16384 bits of data memory. The cell configuration for this element is listed in the following table.

Data Cells		Parity Cells				
Depth	Width	Depth	Width	Address Bus	Data Bus	Parity Bus
8192	2	-	-	(12:0)	(1:0)	-

The enable EN pin controls read, write, and reset. When EN is Low, no data is written and the outputs (DO and DOP) retain the last state. When EN is High and reset (SSR) is High, DO and DOP are set to SRVAL during the Low-to-High clock (CLK) transition; if write enable (WE) is High, the memory contents reflect the data at DI and DIP. When EN is High and WE is Low, the data stored in the RAM address (ADDR) is read during the Low-to-High clock transition. By default, WRITE_MODE=WRITE_FIRST, when EN and WE are High, the data on the data inputs (DI and DIP) is loaded into the word selected by the write address (ADDR) during the Low-to-High clock transition and the data outputs (DO and DOP) reflect the selected (addressed) word.

The above description assumes an active High EN, WE, SSR, and CLK. However, the active level can be changed by placing an inverter on the port. Any inverter placed on a RAMB16 port is absorbed into the block and does not use a CLB resource.

Logic Table

Inputs								Outputs			
GSR	EN	SSR	WE	CLK	ADDR	DI	DIP	DO	DOP	RAM Contents	
										Data RAM	Parity RAM
1	X	X	X	X	X	X	X	INIT	INIT	No Change	No Change
0	0	X	X	X	X	X	X	No Change	No Change	No Change	No Change
0	1	1	0	↑	X	X	X	SRVAL	SRVAL	No Change	No Change
0	1	1	1	↑	addr	data	pdata	SRVAL	SRVAL	RAM(addr) =>data	RAM(addr) =>pdata
0	1	0	0	↑	addr	X	X	RAM (addr)	RAM (addr)	No Change	No Change
0	1	0	1	↑	addr	data	pdata	No Change ¹ RAM	No Change ¹ RAM	RAM (addr)=>data	RAM (addr)=>pdata

Inputs								Outputs			
GSR	EN	SSR	WE	CLK	ADDR	DI	DIP	DO	DOP	RAM Contents	
										Data RAM	Parity RAM
								(addr) ² data ³	(addr) ² pdata ³		
<p>GSR=Global Set Reset signal</p> <p>INIT=Value specified by the INIT attribute for data memory. Default is all zeros.</p> <p>SRVAL=Value after assertion of SSR as specified by the SRVAL attribute.</p> <p>addr=RAM address.</p> <p>RAM(addr)=RAM contents at address ADDR.</p> <p>data=RAM input data.</p> <p>pdata=RAM parity data.</p> <p>¹WRITE_MODE=NO_CHANGE</p> <p>²WRITE_MODE=READ_FIRST</p> <p>³WRITE_MODE=WRITE_FIRST</p>											

Initialization

Initializing Memory Contents

You can use the INIT_xx attributes to specify an initialization value for the memory contents of a RAMB16 during device configuration. The initialization of each RAMB16 is set by 64 initialization attributes (INIT_00 through INIT_3F) of 64 hex values for a total of 16384 bits.

You can use the INITP_xx attributes to specify an initial value for the parity memory during device configuration or assertion. The initialization of the parity memory for ports configured for 9, 18, or 36 bits is set by 8 initialization attributes (INITP_00 through INITP_07) of 64 hex values for a total of 2048 bits.

Any INIT_xx or INITP_xx attribute that is not specified is configured as zeros. Partial Strings are padded with zeros to the left.

Initializing the Output Register

In Spartan®-3A and above devices, each bit in the output register can be initialized at power on to either a 0 or 1. In addition, the initial state specified for power on can be different than the state that results from assertion of a set/reset. Two types of properties control initialization of the output register for a single-port RAMB16: INIT and SRVAL. The INIT attribute specifies the output register value at power on. You can use the SRVAL attribute to define the state resulting from assertion of the SSR (set/reset) input.

The INIT and SRVAL attributes specify the initialization value as a hexadecimal String containing one bit for each bit in the output port. For example, for a RAMB16_S1 with port width equal to 1, the output register contains 1 bit. Therefore, the INIT or SRVAL value can only be specified as a 1 or 0. For RAMB16_S4 with port width equal to 4, the output register contains 4 bits. In this case, you can specify a hexadecimal value from 0 through F to initialize the 4 bits of the output register.

For those ports that include parity bits, the parity portion of the output register is specified in the high order bit position of the INIT or SRVAL value.

Selecting Write Mode

The WRITE_MODE attribute controls RAMB16 memory and output contents. By default, the WRITE_MODE is set to WRITE_FIRST. This means that input is read, written to memory, and then passed to output. You can set the WRITE_MODE to READ_FIRST to read the memory contents, pass the memory contents to the outputs, and then write the input to memory. Or, you can set the WRITE_MODE to NO_CHANGE to have the input written to memory without changing the output.

Design Entry Method

This design element can be used in schematics.

Available Attributes

Attribute	Data Type	Allowed Values	Default	Description
INIT	Binary/ Hexadecimal	Any Hex Value	All zeros	Identifies the initial value of the DO output port after completing configuration. The bit width is dependent on the width of the A or B port of the RAM.
INIT_00 to INIT_3F	Binary/ Hexadecimal	Any Hex Value	All zeros	Specifies the initial contents of the data portion of the RAM array.
INITP_00 to INITP_07	Binary/ Hexadecimal	Any Hex Value	All zeros	Specifies the initial contents of the parity portion of the RAM array.
SRVAL	Binary/ Hexadecimal	Any Hex Value	All zeros	Allows the individual selection of whether the DO output port sets (go to a one) or reset (go to a zero) upon the assertion of the SSR pin. The bit width is dependent on the width of the A or B port of the RAM.
WRITE_MODE	String	"WRITE_FIRST", "READ_FIRST" or "NO_CHANGE"	"WRITE_FIRST"	Specifies the behavior of the DO port upon a write command to the respected port. If set to "WRITE_FIRST", the same port that is written to displays the contents of the written data to the outputs upon completion of the operation. "READ_FIRST" displays the prior contents of the RAM to the output port prior to writing the new data. "NO_CHANGE" keeps the previous value on the output port and won't update the output port upon a write command. This is the suggested mode if not using the read data from a particular port of the RAM.

For More Information

- See the [Spartan-3 Generation FPGA User Guide \(UG331\)](#).
- See the [Spartan-3E FPGA Family Data Sheet \(DS312\)](#).

RAMB16_S2_S18

Primitive: 16K-bit Data and 2K-bit Parity Dual-Port Synchronous Block RAM with 2-bit and 18-bit Ports

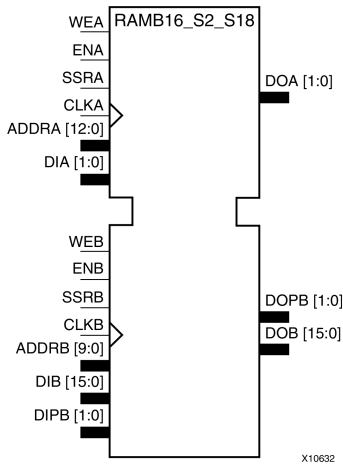

Introduction

This design element is a dual-ported dedicated random access memory block with synchronous write capability. Each block RAM port has 16384 bits of data memory. Ports configured as 9, 18, or 36 bits wide have an additional 2048 bits of parity memory. Each port is independent of the other while accessing the same set of 16384 data memory cells. Each port is independently configured to a specific data width. The possible port and cell configurations for this element are listed in the "Port Descriptions" section.

Logic Table

Truth Table A

Inputs								Outputs			
GSR	ENA	SSRA	WEA	CLKA	ADDRA	DIA	DIPA	DOA	DOPA	RAM Contents	
										Data RAM	Parity RAM
1	X	X	X	X	X	X	X	INIT_A	INIT_A	No Change	No Change
0	0	X	X	X	X	X	X	No Change	No Change	No Change	No Change
0	1	1	0	↑	X	X	X	SRVAL_A	SRVAL_A	No Change	No Change
0	1	1	1	↑	addr	data	pdata	SRVAL_A	SRVAL_A	RAM(addr) =>data	RAM(addr) =>pdata
0	1	0	0	↑	addr	X	X	RAM(addr)	RAM(addr)	No Change	No Change
0	1	0	1	↑	addr	data	pdata	No Change ¹ , RAM(addr) ² , data ³	No Change ¹ , RAM(addr) ² , pdata ³	RAM(addr) =>data	RAM(addr) =>pdata

GSR=Global Set Reset.

INIT_A=Value specified by the INIT_A attribute for output register. Default is all zeros.

SRVAL_A=register value.

addr=RAM address.

RAM(addr)=RAM contents at address ADDR.

Inputs								Outputs		
GSR	ENA	SSRA	WEA	CLKA	ADDRA	DIA	DIPA	DOA	DOPA	RAM Contents
									Data RAM	Parity RAM
<p>data=RAM input data.</p> <p>pdata=RAM parity data.</p> <p>¹WRITE_MODE_A=NO_CHANGE.</p> <p>²WRITE_MODE_A=READ_FIRST.</p> <p>³WRITE_MODE_A=WRITE_FIRST.</p>										

Truth Table B

Inputs								Outputs			
GSR	ENB	SSRB	WEB	CLKB	ADDRB	DIB	DIPB	DOB	DOPB	RAM Contents	
										Data RAM	Parity RAM
1	X	X	X	X	X	X	X	INIT_B	INIT_B	No Change	No Change
0	0	X	X	X	X	X	X	No Change	No Change	No Change	No Change
0	1	1	0	↑	X	X	X	SRVAL_B	SRVAL_B	No Change	No Change
0	1	1	1	↑	addr	data	pdata	SRVAL_B	SRVAL_B	RAM(addr) =>data	RAM(addr) =>pdata
0	1	0	0	↑	addr	X	X	RAM(addr)	RAM(addr)	No Change	No Change
0	1	0	1	↑	addr	data	pdata	No Change ¹ , RAM(addr) ² , data ³	No Change ¹ , RAM(addr) ² , pdata ³	RAM(addr) =>data	RAM(addr) =>pdata

GSR=Global Set Reset.
 INIT_B=Value specified by the INIT_B attribute for output registers. Default is all zeros.
 SRVAL_B=register value.
 addr=RAM address.
 RAM(addr)=RAM contents at address ADDR.
 data=RAM input data.
 pdata=RAM parity data.
¹WRITE_MODE_B=NO_CHANGE.
²WRITE_MODE_B=READ_FIRST.
³WRITE_MODE_B=WRITE_FIRST.

Port Descriptions

Port A						Port B				
Design Element	Data Cells ¹	Parity Cells ¹	Address Bus	Data Bus	Parity Bus	Data Cells ¹	Parity Cells ¹	Address Bus	Data Bus	Parity Bus
RAMB16_S2_S18	8192 x 2	-	(12:0)	(1:0)	-	1024 x 16	1024 x 2	(9:0)	(15:0)	(1:0)

¹Depth x Width

Each port is fully synchronous with independent clock pins. All Port A input pins have setup time referenced to the CLKA pin and its data output bus DOA has a clock-to-out time referenced to the CLKA. All Port B input pins have setup time referenced to the CLKB pin and its data output bus DOB has a clock-to-out time referenced to the CLKB. The enable ENA pin controls read, write, and reset for Port A. When ENA is Low, no data is written and the outputs (DOA and DOPA) retain the last state. When ENA is High and reset (SSRA) is High, DOA and DOPA are set to SRVAL_A during the Low-to-High clock (CLKA) transition; if write enable (WEA) is High, the memory contents reflect the data at DIA and DIPA. When ENA is High and WEA is Low, the data stored in the RAM address (ADDR_A) is read during the Low-to-High clock transition. By default, WRITE_MODE_A=WRITE_FIRST, when ENA and WEA are High, the data on the data inputs (DIA and DIPA) is loaded into the word selected by the write address (ADDR_A) during the Low-to-High clock transition and the data outputs (DOA and DOPA) reflect the selected (addressed) word.

In Spartan®-3A and above devices, each bit in an output register can be initialized at power on (when GSR is high) to either a 0 or 1. In addition, the initial state specified for power on can be different than the state that results from assertion of a set/reset. Four properties control initialization of the output register for a dual-port RAMB16: INIT_A, INIT_B, SRVAL_A, and SRVAL_B. The INIT_A attribute specifies the output register value at power on for Port A and the INIT_B attribute specifies the value for Port B. You can use the SRVAL_A attribute to define the state resulting from assertion of the SSR (set/reset) input on Port A. You can use the SRVAL_B attribute to define the state resulting from assertion of the SSR input on Port B.

The INIT_A, INIT_B, SRVAL_A, and SRVAL_B attributes specify the initialization value as a hexadecimal String. The value is dependent upon the port width. For example, for a RAMB16_S1_S4 with Port A width equal to 1 and Port B width equal to 4, the Port A output register contains 1 bit and the Port B output register contains 4 bits. Therefore, the INIT_A or SRVAL_A value can only be specified as a 1 or 0. For Port B, the output register contains 4 bits. In this case, you can use INIT_B or SRVAL_B to specify a hexadecimal value from 0 through F to initialize the 4 bits of the output register.

For those ports that include parity bits, the parity portion of the output register is specified in the high order bit position of the INIT_A, INIT_B, SRVAL_A, or SRVAL_B value.

The INIT and SRVAL attributes default to zero if they are not set by you.

Write Mode Selection

The WRITE_MODE_A attribute controls the memory and output contents of Port A for a dual-port RAMB16. The WRITE_MODE_B attribute does the same for Port B. By default, both WRITE_MODE_A and WRITE_MODE_B are set to WRITE_FIRST. This means that input is read, written to memory, and then passed to output. You can set the write mode for Port A and Port B to READ_FIRST to read the memory contents, pass the memory contents to the outputs, and then write the input to memory. Or, you can set the write mode to NO_CHANGE to have the input written to memory without changing the output. The Port A and Port B Conflict Resolution section describes how read/write conflicts are resolved when both Port A and Port B are attempting to read/write to the same memory cells.

Port A and Port B Conflict Resolution

Spartan-3A block SelectIO™ is True Dual-Port RAM that allows both ports to simultaneously access the same memory cell. When one port writes to a given memory cell, the other port must not address that memory cell (for a write or a read) within the clock-to-clock setup window.

The following tables summarize the collision detection behavior of the dual-port RAMB16 based on the WRITE_MODE_A and WRITE_MODE_B settings.

WRITE_MODE_A=NO_CHANGE and WRITE_MODE_B=NO_CHANGE

WEA	WEB	CLKA	CLKB	DIA	DIB	DIPA	DIPB	DOA	DOB	DOPA	DOPB	Data RAM	Parity Ram
0	0	↑	↑	DIA	DIB	DIPA	DIPB	RAM	RAM	RAM	RAM	No Change	No Change
1	0	↑	↑	DIA	DIB	DIPA	DIPB	No Change	X	No Change	X	DIA	DIPA
0	1	↑	↑	DIA	DIB	DIPA	DIPB	X	No Change	X	No Change	DIB	DIPB
1	1	↑	↑	DIA	DIB	DIPA	DIPB	No Change	No Change	No Change	No Change	X	X

WRITE_MODE_A=READ_FIRST and WRITE_MODE_B=READ_FIRST

WEA	WEB	CLKA	CLKB	DIA	DIB	DIPA	DIPB	DOA	DOB	DOPA	DOPB	Data RAM	Parity Ram
0	0	↑	↑	DIA	DIB	DIPA	DIPB	RAM	RAM	RAM	RAM	No Change	No Change
1	0	↑	↑	DIA	DIB	DIPA	DIPB	RAM	RAM	RAM	RAM	DIA	DIPA

WEA	WEB	CLKA	CLKB	DIA	DIB	DIPA	DIPB	DOA	DOB	DOPA	DOPB	Data RAM	Parity Ram
0	1	↑	↑	DIA	DIB	DIPA	DIPB	RAM	RAM	RAM	RAM	DIB	DIPB
1	1	↑	↑	DIA	DIB	DIPA	DIPB	RAM	RAM	RAM	RAM	X	X

WRITE_MODE_A= WRITE_FIRST and WRITE_MODE_B=WRITE_FIRST

WEA	WEB	CLKA	CLKB	DIA	DIB	DIPA	DIPB	DOA	DOB	DOPA	DOPB	Data RAM	Parity Ram
0	0	↑	↑	DIA	DIB	DIPA	DIPB	RAM	RAM	RAM	RAM	No Change	No Change
1	0	↑	↑	DIA	DIB	DIPA	DIPB	DIA	X	DIPA	X	DIA	DIPA
0	1	↑	↑	DIA	DIB	DIPA	DIPB	X	DIB	X	DIPB	DIB	DIPB
1	1	↑	↑	DIA	DIB	DIPA	DIPB	X	X	X	X	X	X

WRITE_MODE_A=NO_CHANGE and WRITE_MODE_B=READ_FIRST

WEA	WEB	CLKA	CLKB	DIA	DIB	DIPA	DIPB	DOA	DOB	DOPA	DOPB	Data RAM	Parity Ram
0	0	↑	↑	DIA	DIB	DIPA	DIPB	RAM	RAM	RAM	RAM	No Change	No Change
1	0	↑	↑	DIA	DIB	DIPA	DIPB	No Change	X	No Change	X	DIA	DIPA
0	1	↑	↑	DIA	DIB	DIPA	DIPB	RAM	RAM	RAM	RAM	DIB	DIPB
1	1	↑	↑	DIA	DIB	DIPA	DIPB	No Change	X	No Change	X	DIB	DIPB

WRITE_MODE_A=NO_CHANGE and WRITE_MODE_B=WRITE_FIRST

WEA	WEB	CLKA	CLKB	DIA	DIB	DIPA	DIPB	DOA	DOB	DOPA	DOPB	Data RAM	Parity Ram
0	0	↑	↑	DIA	DIB	DIPA	DIPB	RAM	RAM	RAM	RAM	No Change	No Change
1	0	↑	↑	DIA	DIB	DIPA	DIPB	No Change	X	No Change	X	DIA	DIPA
0	1	↑	↑	DIA	DIB	DIPA	DIPB	X	DIB	X	DIPB	DIB	DIPB
1	1	↑	↑	DIA	DIB	DIPA	DIPB	No Change	X	No Change	X	X	X

WRITE_MODE_A=READ_FIRST and WRITE_MODE_B=WRITE_FIRST

WEA	WEB	CLKA	CLKB	DIA	DIB	DIPA	DIPB	DOA	DOB	DOPA	DOPB	Data RAM	Parity Ram
0	0	↑	↑	DIA	DIB	DIPA	DIPB	RAM	RAM	RAM	RAM	No Change	No Change
1	0	↑	↑	DIA	DIB	DIPA	DIPB	RAM	RAM	RAM	RAM	DIA	DIPA
0	1	↑	↑	DIA	DIB	DIPA	DIPB	X	DIB	X	DIPB	DIB	DIPB
1	1	↑	↑	DIA	DIB	DIPA	DIPB	X	DIB	X	DIPB	DIA	DIPA

Design Entry Method

This design element can be used in schematics.

Available Attributes

Attribute	Data Type	Allowed Values	Default	Description
INIT_00 to INIT_3F	Binary/ Hexadecimal	Any	All zeros	Specifies the initial contents of the data portion of the RAM array.
INIT_A	Binary/ Hexadecimal	Any	All zeros	Specifies the initial value of the DOA output port after completing configuration. For Type, the bit width is dependent on the width of the A port of the RAM.
INIT_B	Binary/ Hexadecimal	Any	All zeros	Specifies the initial value of the DOB output port after completing configuration. For Type, the bit width is dependent on the width of the B port of the RAM.
INITP_00 to INITP_07	Binary/ Hexadecimal	Any	All zeros	Specifies the initial contents of the parity portion of the RAM array.
SIM_COLLISION_CHECK	String	"ALL", "WARNING_ONLY", "GENERATE_X_ONLY", "NONE"	"ALL"	<p>Allows modification of the simulation behavior if a memory collision occurs. The output is affected as follows:</p> <ul style="list-style-type: none"> "ALL" - Warning produced and affected outputs/memory location go unknown (X). "WARNING_ONLY" - Warning produced and affected outputs/memory retain last value. "GENERATE_X_ONLY" - No warning. However, affected outputs/memory go unknown (X). "NONE" - No warning and affected outputs/memory retain last value. <p>Note Setting this to a value other than "ALL" can allow problems in the design go unnoticed during simulation. Care should be taken when changing the value of this attribute. Please see the <i>Synthesis and Simulation Design Guide</i> for more information.</p>
SRVAL_A	Binary/ Hexadecimal	Any	All zeros	Sets on a per-bit basis whether the DOA output port sets (goes to a one) or resets (goes to a zero) upon the assertion of the RSTA pin. For Type, the bit width is dependent on the width of the A port of the RAM. Default is all bits reset.
SRVAL_B	Binary/ Hexadecimal	Any	All zeros	Sets on a per-bit basis whether the DOB output port sets (goes to a one) or resets (goes to a zero) upon the assertion of the RSTB pin. For Type, the bit width is dependent on the width of the B port of the RAM. Default is all bits reset.

Attribute	Data Type	Allowed Values	Default	Description
WRITE_MODE_A	String	"WRITE_FIRST", "READ_FIRST", "NO_CHANGE"	"WRITE_FIRST"	<p>Specifies the behavior of the DOA port upon a write command to the port.</p> <ul style="list-style-type: none"> "WRITE_FIRST" - the same port that is written to displays the contents of the written data to the outputs upon completion of the operation. "READ_FIRST" - displays the prior contents of the RAM to the output port prior to writing the new data. "NO_CHANGE" - keeps the previous value on the output port and does not update the output port upon a write command. This is the suggested mode if not using the read data from a particular port of the RAM.
WRITE_MODE_B	String	"WRITE_FIRST", "READ_FIRST", "NO_CHANGE"	"WRITE_FIRST"	<p>Specifies the behavior of the DOB port upon a write command to the port.</p> <ul style="list-style-type: none"> "WRITE_FIRST" - the same port that is written to displays the contents of the written data to the outputs upon completion of the operation. "READ_FIRST" - displays the prior contents of the RAM to the output port prior to writing the new data. "NO_CHANGE" - keeps the previous value on the output port and does not update the output port upon a write command. This is the suggested mode if not using the read data from a particular port of the RAM.

For More Information

- See the [Spartan-3 Generation FPGA User Guide \(UG331\)](#).
- See the [Spartan-3E FPGA Family Data Sheet \(DS312\)](#).

RAMB16_S2_S2

Primitive: 16K-bit Data and 2K-bit Parity Dual-Port Synchronous Block RAM with 2-bit Ports

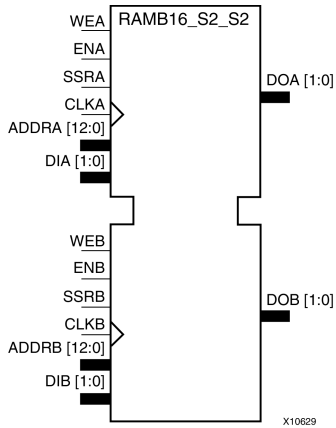

Introduction

This design element is a dual-ported dedicated random access memory block with synchronous write capability. Each block RAM port has 16384 bits of data memory. Ports configured as 9, 18, or 36 bits wide have an additional 2048 bits of parity memory. Each port is independent of the other while accessing the same set of 16384 data memory cells. Each port is independently configured to a specific data width. The possible port and cell configurations for this element are listed in the "Port Descriptions" section.

Logic Table

Truth Table A

Inputs								Outputs			
GSR	ENA	SSRA	WEA	CLKA	ADDR_A	DIA	DIPA	DOA	DOPA	RAM Contents	
										Data RAM	Parity RAM
1	X	X	X	X	X	X	X	INIT_A	INIT_A	No Change	No Change
0	0	X	X	X	X	X	X	No Change	No Change	No Change	No Change
0	1	1	0	↑	X	X	X	SRVAL_A	SRVAL_A	No Change	No Change
0	1	1	1	↑	addr	data	pdata	SRVAL_A	SRVAL_A	RAM(addr) =>data	RAM(addr) =>pdata
0	1	0	0	↑	addr	X	X	RAM(addr)	RAM(addr)	No Change	No Change
0	1	0	1	↑	addr	data	pdata	No Change ¹ , RAM(addr) ² , data ³	No Change ¹ , RAM(addr) ² , pdata ³	RAM(addr) =>data	RAM(addr) =>pdata

GSR=Global Set Reset.

INIT_A=Value specified by the INIT_A attribute for output register. Default is all zeros.

SRVAL_A=register value.

addr=RAM address.

RAM(addr)=RAM contents at address ADDR.

data=RAM input data.

pdata=RAM parity data.

Inputs								Outputs		
GSR	ENA	SSRA	WEA	CLKA	ADDRA	DIA	DIPA	DOA	DOPA	RAM Contents
									Data RAM	Parity RAM
¹ WRITE_MODE_A=NO_CHANGE. ² WRITE_MODE_A=READ_FIRST. ³ WRITE_MODE_A=WRITE_FIRST.										

Truth Table B

Inputs								Outputs			
GSR	ENB	SSRB	WEB	CLKB	ADDRB	DIB	DIPB	DOB	DOPB	RAM Contents	
										Data RAM	Parity RAM
1	X	X	X	X	X	X	X	INIT_B	INIT_B	No Change	No Change
0	0	X	X	X	X	X	X	No Change	No Change	No Change	No Change
0	1	1	0	↑	X	X	X	SRVAL_B	SRVAL_B	No Change	No Change
0	1	1	1	↑	addr	data	pdata	SRVAL_B	SRVAL_B	RAM(addr) =>data	RAM(addr) =>pdata
0	1	0	0	↑	addr	X	X	RAM(addr)	RAM(addr)	No Change	No Change
0	1	0	1	↑	addr	data	pdata	No Change ¹ , RAM(addr) ² , data ³	No Change ¹ , RAM(addr) ² , pdata ³	RAM(addr) =>data	RAM(addr) =>pdata

GSR=Global Set Reset.
 INIT_B=Value specified by the INIT_B attribute for output registers. Default is all zeros.
 SRVAL_B=register value.
 addr=RAM address.
 RAM(addr)=RAM contents at address ADDR.
 data=RAM input data.
 pdata=RAM parity data.
¹WRITE_MODE_B=NO_CHANGE.
²WRITE_MODE_B=READ_FIRST.
³WRITE_MODE_B=WRITE_FIRST.

Port Descriptions

Port A						Port B				
Design Element	Data Cells ¹	Parity Cells ¹	Address Bus	Data Bus	Parity Bus	Data Cells ¹	Parity Cells ¹	Address Bus	Data Bus	Parity Bus
RAMB16_S2_S2	8192 x 2	-	(12:0)	(1:0)	-	8192 x 2	-	(12:0)	(1:0)	-

¹Depth x Width

Each port is fully synchronous with independent clock pins. All Port A input pins have setup time referenced to the CLKA pin and its data output bus DOA has a clock-to-out time referenced to the CLKA. All Port B input pins have setup time referenced to the CLKB pin and its data output bus DOB has a clock-to-out time referenced to the CLKB. The enable ENA pin controls read, write, and reset for Port A. When ENA is Low, no data is written and the outputs (DOA and DOPA) retain the last state. When ENA is High and reset (SSRA) is High, DOA and DOPA are set to SRVAL_A during the Low-to-High clock (CLKA) transition; if write enable (WEA) is High, the memory contents reflect the data at DIA and DIPA. When ENA is High and WEA is Low, the data stored in the RAM address (ADDRA) is read during the Low-to-High clock transition. By default, WRITE_MODE_A=WRITE_FIRST, when ENA and WEA are High, the data on the data inputs (DIA and DIPA) is loaded into the word selected by the write address (ADDRA) during the Low-to-High clock transition and the data outputs (DOA and DOPA) reflect the selected (addressed) word.

In Spartan®-3A and above devices, each bit in an output register can be initialized at power on (when GSR is high) to either a 0 or 1. In addition, the initial state specified for power on can be different than the state that results from assertion of a set/reset. Four properties control initialization of the output register for a dual-port RAMB16: INIT_A, INIT_B, SRVAL_A, and SRVAL_B. The INIT_A attribute specifies the output register value at power on for Port A and the INIT_B attribute specifies the value for Port B. You can use the SRVAL_A attribute to define the state resulting from assertion of the SSR (set/reset) input on Port A. You can use the SRVAL_B attribute to define the state resulting from assertion of the SSR input on Port B.

The INIT_A, INIT_B, SRVAL_A, and SRVAL_B attributes specify the initialization value as a hexadecimal String. The value is dependent upon the port width. For example, for a RAMB16_S1_S4 with Port A width equal to 1 and Port B width equal to 4, the Port A output register contains 1 bit and the Port B output register contains 4 bits. Therefore, the INIT_A or SRVAL_A value can only be specified as a 1 or 0. For Port B, the output register contains 4 bits. In this case, you can use INIT_B or SRVAL_B to specify a hexadecimal value from 0 through F to initialize the 4 bits of the output register.

For those ports that include parity bits, the parity portion of the output register is specified in the high order bit position of the INIT_A, INIT_B, SRVAL_A, or SRVAL_B value.

The INIT and SRVAL attributes default to zero if they are not set by you.

Write Mode Selection

The WRITE_MODE_A attribute controls the memory and output contents of Port A for a dual-port RAMB16. The WRITE_MODE_B attribute does the same for Port B. By default, both WRITE_MODE_A and WRITE_MODE_B are set to WRITE_FIRST. This means that input is read, written to memory, and then passed to output. You can set the write mode for Port A and Port B to READ_FIRST to read the memory contents, pass the memory contents to the outputs, and then write the input to memory. Or, you can set the write mode to NO_CHANGE to have the input written to memory without changing the output. The Port A and Port B Conflict Resolution section describes how read/write conflicts are resolved when both Port A and Port B are attempting to read/write to the same memory cells.

Port A and Port B Conflict Resolution

Spartan-3A block SelectRAM™ is True Dual-Port RAM that allows both ports to simultaneously access the same memory cell. When one port writes to a given memory cell, the other port must not address that memory cell (for a write or a read) within the clock-to-clock setup window.

The following tables summarize the collision detection behavior of the dual-port RAMB16 based on the WRITE_MODE_A and WRITE_MODE_B settings.

WRITE_MODE_A=NO_CHANGE and WRITE_MODE_B=NO_CHANGE

WEA	WEB	CLKA	CLKB	DIA	DIB	DIPA	DIPB	DOA	DOB	DOPA	DOPB	Data RAM	Parity Ram
0	0	↑	↑	DIA	DIB	DIPA	DIPB	RAM	RAM	RAM	RAM	No Change	No Change
1	0	↑	↑	DIA	DIB	DIPA	DIPB	No Change	X	No Change	X	DIA	DIPA
0	1	↑	↑	DIA	DIB	DIPA	DIPB	X	No Change	X	No Change	DIB	DIPB
1	1	↑	↑	DIA	DIB	DIPA	DIPB	No Change	No Change	No Change	No Change	X	X

WRITE_MODE_A=READ_FIRST and WRITE_MODE_B=READ_FIRST

WEA	WEB	CLKA	CLKB	DIA	DIB	DIPA	DIPB	DOA	DOB	DOPA	DOPB	Data RAM	Parity Ram
0	0	↑	↑	DIA	DIB	DIPA	DIPB	RAM	RAM	RAM	RAM	No Change	No Change
1	0	↑	↑	DIA	DIB	DIPA	DIPB	RAM	RAM	RAM	RAM	DIA	DIPA

WEA	WEB	CLKA	CLKB	DIA	DIB	DIPA	DIPB	DOA	DOB	DOPA	DOPB	Data RAM	Parity Ram
0	1	↑	↑	DIA	DIB	DIPA	DIPB	RAM	RAM	RAM	RAM	DIB	DIPB
1	1	↑	↑	DIA	DIB	DIPA	DIPB	RAM	RAM	RAM	RAM	X	X

WRITE_MODE_A= WRITE_FIRST and WRITE_MODE_B=WRITE_FIRST

WEA	WEB	CLKA	CLKB	DIA	DIB	DIPA	DIPB	DOA	DOB	DOPA	DOPB	Data RAM	Parity Ram
0	0	↑	↑	DIA	DIB	DIPA	DIPB	RAM	RAM	RAM	RAM	No Change	No Change
1	0	↑	↑	DIA	DIB	DIPA	DIPB	DIA	X	DIPA	X	DIA	DIPA
0	1	↑	↑	DIA	DIB	DIPA	DIPB	X	DIB	X	DIPB	DIB	DIPB
1	1	↑	↑	DIA	DIB	DIPA	DIPB	X	X	X	X	X	X

WRITE_MODE_A=NO_CHANGE and WRITE_MODE_B=READ_FIRST

WEA	WEB	CLKA	CLKB	DIA	DIB	DIPA	DIPB	DOA	DOB	DOPA	DOPB	Data RAM	Parity Ram
0	0	↑	↑	DIA	DIB	DIPA	DIPB	RAM	RAM	RAM	RAM	No Change	No Change
1	0	↑	↑	DIA	DIB	DIPA	DIPB	No Change	X	No Change	X	DIA	DIPA
0	1	↑	↑	DIA	DIB	DIPA	DIPB	RAM	RAM	RAM	RAM	DIB	DIPB
1	1	↑	↑	DIA	DIB	DIPA	DIPB	No Change	X	No Change	X	DIB	DIPB

WRITE_MODE_A=NO_CHANGE and WRITE_MODE_B=WRITE_FIRST

WEA	WEB	CLKA	CLKB	DIA	DIB	DIPA	DIPB	DOA	DOB	DOPA	DOPB	Data RAM	Parity Ram
0	0	↑	↑	DIA	DIB	DIPA	DIPB	RAM	RAM	RAM	RAM	No Change	No Change
1	0	↑	↑	DIA	DIB	DIPA	DIPB	No Change	X	No Change	X	DIA	DIPA
0	1	↑	↑	DIA	DIB	DIPA	DIPB	X	DIB	X	DIPB	DIB	DIPB
1	1	↑	↑	DIA	DIB	DIPA	DIPB	No Change	X	No Change	X	X	X

WRITE_MODE_A=READ_FIRST and WRITE_MODE_B=WRITE_FIRST

WEA	WEB	CLKA	CLKB	DIA	DIB	DIPA	DIPB	DOA	DOB	DOPA	DOPB	Data RAM	Parity Ram
0	0	↑	↑	DIA	DIB	DIPA	DIPB	RAM	RAM	RAM	RAM	No Change	No Change
1	0	↑	↑	DIA	DIB	DIPA	DIPB	RAM	RAM	RAM	RAM	DIA	DIPA
0	1	↑	↑	DIA	DIB	DIPA	DIPB	X	DIB	X	DIPB	DIB	DIPB
1	1	↑	↑	DIA	DIB	DIPA	DIPB	X	DIB	X	DIPB	DIA	DIPA

Design Entry Method

This design element can be used in schematics.

Available Attributes

Attribute	Data Type	Allowed Values	Default	Description
INIT_00 to INIT_3F	Binary/ Hexadecimal	Any	All zeros	Specifies the initial contents of the data portion of the RAM array.
INIT_A	Binary/ Hexadecimal	Any	All zeros	Specifies the initial value of the DOA output port after completing configuration. For Type, the bit width is dependent on the width of the A port of the RAM.
INIT_B	Binary/ Hexadecimal	Any	All zeros	Specifies the initial value of the DOB output port after completing configuration. For Type, the bit width is dependent on the width of the B port of the RAM.
INITP_00 to INITP_07	Binary/ Hexadecimal	Any	All zeros	Specifies the initial contents of the parity portion of the RAM array.
SIM_COLLISION_CHECK	String	"ALL", "WARNING_ONLY", "GENERATE_X_ONLY", "NONE"	"ALL"	<p>Allows modification of the simulation behavior if a memory collision occurs. The output is affected as follows:</p> <ul style="list-style-type: none"> "ALL" - Warning produced and affected outputs/memory location go unknown (X). "WARNING_ONLY" - Warning produced and affected outputs/memory retain last value. "GENERATE_X_ONLY" - No warning. However, affected outputs/memory go unknown (X). "NONE" - No warning and affected outputs/memory retain last value. <p>Note Setting this to a value other than "ALL" can allow problems in the design go unnoticed during simulation. Care should be taken when changing the value of this attribute. Please see the <i>Synthesis and Simulation Design Guide</i> for more information.</p>
SRVAL_A	Binary/ Hexadecimal	Any	All zeros	Sets on a per-bit basis whether the DOA output port sets (goes to a one) or resets (goes to a zero) upon the assertion of the RSTA pin. For Type, the bit width is dependent on the width of the A port of the RAM. Default is all bits reset.
SRVAL_B	Binary/ Hexadecimal	Any	All zeros	Sets on a per-bit basis whether the DOB output port sets (goes to a one) or resets (goes to a zero) upon the assertion of the RSTB pin. For Type, the bit width is dependent on the width of the B port of the RAM. Default is all bits reset.

Attribute	Data Type	Allowed Values	Default	Description
WRITE_MODE_A	String	"WRITE_FIRST", "READ_FIRST", "NO_CHANGE"	"WRITE_FIRST"	<p>Specifies the behavior of the DOA port upon a write command to the port.</p> <ul style="list-style-type: none"> "WRITE_FIRST" - the same port that is written to displays the contents of the written data to the outputs upon completion of the operation. "READ_FIRST" - displays the prior contents of the RAM to the output port prior to writing the new data. "NO_CHANGE" - keeps the previous value on the output port and does not update the output port upon a write command. This is the suggested mode if not using the read data from a particular port of the RAM.
WRITE_MODE_B	String	"WRITE_FIRST", "READ_FIRST", "NO_CHANGE"	"WRITE_FIRST"	<p>Specifies the behavior of the DOB port upon a write command to the port.</p> <ul style="list-style-type: none"> "WRITE_FIRST" - the same port that is written to displays the contents of the written data to the outputs upon completion of the operation. "READ_FIRST" - displays the prior contents of the RAM to the output port prior to writing the new data. "NO_CHANGE" - keeps the previous value on the output port and does not update the output port upon a write command. This is the suggested mode if not using the read data from a particular port of the RAM.

For More Information

- See the [Spartan-3 Generation FPGA User Guide \(UG331\)](#).
- See the [Spartan-3E FPGA Family Data Sheet \(DS312\)](#).

RAMB16_S2_S36

Primitive: 16K-bit Data and 2K-bit Parity Dual-Port Synchronous Block RAM with 2-bit and 36-bit Ports

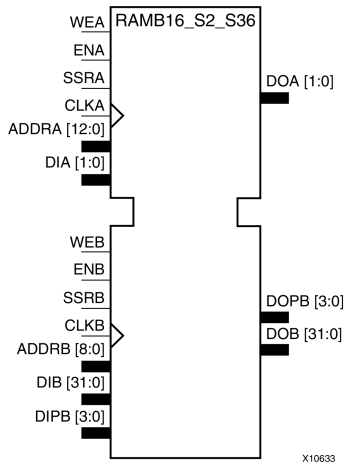

Introduction

This design element is a dual-ported dedicated random access memory block with synchronous write capability. Each block RAM port has 16384 bits of data memory. Ports configured as 9, 18, or 36 bits wide have an additional 2048 bits of parity memory. Each port is independent of the other while accessing the same set of 16384 data memory cells. Each port is independently configured to a specific data width. The possible port and cell configurations for this element are listed in the "Port Descriptions" section.

Logic Table

Truth Table A

Inputs								Outputs			
GSR	ENA	SSRA	WEA	CLKA	ADDRA	DIA	DIPA	DOA	DOPA	RAM Contents	
										Data RAM	Parity RAM
1	X	X	X	X	X	X	X	INIT_A	INIT_A	No Change	No Change
0	0	X	X	X	X	X	X	No Change	No Change	No Change	No Change
0	1	1	0	↑	X	X	X	SRVAL_A	SRVAL_A	No Change	No Change
0	1	1	1	↑	addr	data	pdata	SRVAL_A	SRVAL_A	RAM(addr) =>data	RAM(addr) =>pdata
0	1	0	0	↑	addr	X	X	RAM(addr)	RAM(addr)	No Change	No Change
0	1	0	1	↑	addr	data	pdata	No Change ¹ , RAM(addr) ² , data ³	No Change ¹ , RAM(addr) ² , pdata ³	RAM(addr) =>data	RAM(addr) =>pdata

GSR=Global Set Reset.

INIT_A=Value specified by the INIT_A attribute for output register. Default is all zeros.

SRVAL_A=register value.

addr=RAM address.

RAM(addr)=RAM contents at address ADDR.

Inputs								Outputs			
GSR	ENA	SSRA	WEA	CLKA	ADDRA	DIA	DIPA	DOA	DOPA	RAM Contents	
									Data RAM	Parity RAM	
<p>data=RAM input data.</p> <p>pdata=RAM parity data.</p> <p>¹WRITE_MODE_A=NO_CHANGE.</p> <p>²WRITE_MODE_A=READ_FIRST.</p> <p>³WRITE_MODE_A=WRITE_FIRST.</p>											

Truth Table B

Inputs								Outputs			
GSR	ENB	SSRB	WEB	CLKB	ADDRB	DIB	DIPB	DOB	DOPB	RAM Contents	
										Data RAM	Parity RAM
1	X	X	X	X	X	X	X	INIT_B	INIT_B	No Change	No Change
0	0	X	X	X	X	X	X	No Change	No Change	No Change	No Change
0	1	1	0	↑	X	X	X	SRVAL_B	SRVAL_B	No Change	No Change
0	1	1	1	↑	addr	data	pdata	SRVAL_B	SRVAL_B	RAM(addr) =>data	RAM(addr) =>pdata
0	1	0	0	↑	addr	X	X	RAM(addr)	RAM(addr)	No Change	No Change
0	1	0	1	↑	addr	data	pdata	No Change ¹ , RAM(addr) ² , data ³	No Change ¹ , RAM(addr) ² , pdata ³	RAM(addr) =>data	RAM(addr) =>pdata

GSR=Global Set Reset.
 INIT_B=Value specified by the INIT_B attribute for output registers. Default is all zeros.
 SRVAL_B=register value.
 addr=RAM address.
 RAM(addr)=RAM contents at address ADDR.
 data=RAM input data.
 pdata=RAM parity data.
¹WRITE_MODE_B=NO_CHANGE.
²WRITE_MODE_B=READ_FIRST.
³WRITE_MODE_B=WRITE_FIRST.

Port Descriptions

Port A						Port B				
Design Element	Data Cells ¹	Parity Cells ¹	Address Bus	Data Bus	Parity Bus	Data Cells ¹	Parity Cells ¹	Address Bus	Data Bus	Parity Bus
RAMB16_S2_S36	8192 x 2	-	(12:0)	(1:0)	-	512 x 32	512 x 4	(8:0)	(31:0)	(3:0)

¹Depth x Width

Each port is fully synchronous with independent clock pins. All Port A input pins have setup time referenced to the CLKA pin and its data output bus DOA has a clock-to-out time referenced to the CLKA. All Port B input pins have setup time referenced to the CLKB pin and its data output bus DOB has a clock-to-out time referenced to the CLKB. The enable ENA pin controls read, write, and reset for Port A. When ENA is Low, no data is written and the outputs (DOA and DOPA) retain the last state. When ENA is High and reset (SSRA) is High, DOA and DOPA are set to SRVAL_A during the Low-to-High clock (CLKA) transition; if write enable (WEA) is High, the memory contents reflect the data at DIA and DIPA. When ENA is High and WEA is Low, the data stored in the RAM address (ADDRA) is read during the Low-to-High clock transition. By default, WRITE_MODE_A=WRITE_FIRST, when ENA and WEA are High, the data on the data inputs (DIA and DIPA) is loaded into the word selected by the write address (ADDRA) during the Low-to-High clock transition and the data outputs (DOA and DOPA) reflect the selected (addressed) word.

The enable ENB pin controls read, write, and reset for Port B. When ENB is Low, no data is written and the outputs (DOB and DOPB) retain the last state. When ENB is High and reset (SSRB) is High, DOB and DOPB are set to SRVAL_B during the Low-to-High clock (CLKB) transition; if write enable (WEB) is High, the memory contents reflect the data at DIB and DIPB. When ENB is High and WEB is Low, the data stored in the RAM address (ADDRB) is read during the Low-to-High clock transition. By default, WRITE_MODE_B=WRITE_FIRST, when ENB and WEB are High, the data on the data inputs (DIB and PB) are loaded into the word selected by the write address (ADDRB) during the Low-to-High clock transition and the data outputs (DOB and DOPB) reflect the selected (addressed) word. The above descriptions assume active High control pins (ENA, WEA, SSRB, CLKA, ENB, WEB, SSRB, and CLKB). However, the active level can be changed by placing an inverter on the port. Any inverter placed on a RAMB16 port is absorbed into the block and does not use a CLB resource.

Address Mapping

Each port accesses the same set of 18432 memory cells using an addressing scheme that is dependent on the width of the port. For all port widths, 16384 memory cells are available for data as shown in the Port Address Mapping for Data table below. For 9-, 18-, and 36-bit wide ports, 2408 parity memory cells are also available as shown in Port Address Mapping for Parity table below. The physical RAM location that is addressed for a particular width is determined from the following formula.

$$\text{Start} = ((\text{ADDR port} + 1) * (\text{Widthport})) - 1$$

$$\text{End} = (\text{ADDRport}) * (\text{Widthport})$$

The following tables shows address mapping for each port width.

Port Address Mapping for Data

Data Width	Port Data Addresses																																		
1	16384	<--	31	30	29	28	27	26	25	24	23	22	21	20	19	18	17	16	15	14	13	12	11	10	9	8	7	6	5	4	3	2	1	0	
2	8192	<--	15		14		13		12		11		10		9		8		7		6		5		4		3		2		1		0		
4	4096	<--	7				6				5				4				3				2				1				0				
8	2048	<--	3								2								1								0								
16	1024	<--	1																0																
32	512	<--	0																																

Port Address Mapping for Parity

Parity Width	Port Parity Addresses																																				
1	2048	<-----	3												2																					0	
2	1024	<-----	1																																		
4	512	<-----	0																																		

Initializing Memory Contents of a Dual-Port RAMB16

You can use the INIT_xx attributes to specify an initialization value for the memory contents of a RAMB16 during device configuration. The initialization of each RAMB16_Sm_Sn is set by 64 initialization attributes (INIT_00 through INIT_3F) of 64 hex values for a total of 16384 bits.

You can use the INITP_xx attributes to specify an initial value for the parity memory during device configuration or assertion. The initialization of the parity memory for ports configured for 9, 18, or 36 bits is set by 8 initialization attributes (INITP_00 through INITP_07) of 64 hex values for a total of 2048 bits.

If any INIT_xx or INITP_xx attribute is not specified, it is configured as zeros. Partial Strings are padded with zeros to the left.

Initializing the Output Register of a Dual-Port RAMB16

In Spartan®-3A and above devices, each bit in an output register can be initialized at power on (when GSR is high) to either a 0 or 1. In addition, the initial state specified for power on can be different than the state that results from assertion of a set/reset. Four properties control initialization of the output register for a dual-port RAMB16: INIT_A, INIT_B, SRVAL_A, and SRVAL_B. The INIT_A attribute specifies the output register value at power on for Port A and the INIT_B attribute specifies the value for Port B. You can use the SRVAL_A attribute to define the state resulting from assertion of the SSR (set/reset) input on Port A. You can use the SRVAL_B attribute to define the state resulting from assertion of the SSR input on Port B.

The INIT_A, INIT_B, SRVAL_A, and SRVAL_B attributes specify the initialization value as a hexadecimal String. The value is dependent upon the port width. For example, for a RAMB16_S1_S4 with Port A width equal to 1 and Port B width equal to 4, the Port A output register contains 1 bit and the Port B output register contains 4 bits. Therefore, the INIT_A or SRVAL_A value can only be specified as a 1 or 0. For Port B, the output register contains 4 bits. In this case, you can use INIT_B or SRVAL_B to specify a hexadecimal value from 0 through F to initialize the 4 bits of the output register.

For those ports that include parity bits, the parity portion of the output register is specified in the high order bit position of the INIT_A, INIT_B, SRVAL_A, or SRVAL_B value.

The INIT and SRVAL attributes default to zero if they are not set by you.

Write Mode Selection

The WRITE_MODE_A attribute controls the memory and output contents of Port A for a dual-port RAMB16. The WRITE_MODE_B attribute does the same for Port B. By default, both WRITE_MODE_A and WRITE_MODE_B are set to WRITE_FIRST. This means that input is read, written to memory, and then passed to output. You can set the write mode for Port A and Port B to READ_FIRST to read the memory contents, pass the memory contents to the outputs, and then write the input to memory. Or, you can set the write mode to NO_CHANGE to have the input written to memory without changing the output. The Port A and Port B Conflict Resolution section describes how read/write conflicts are resolved when both Port A and Port B are attempting to read/write to the same memory cells.

Port A and Port B Conflict Resolution

Spartan-3A block SelectRAM™ is True Dual-Port RAM that allows both ports to simultaneously access the same memory cell. When one port writes to a given memory cell, the other port must not address that memory cell (for a write or a read) within the clock-to-clock setup window.

The following tables summarize the collision detection behavior of the dual-port RAMB16 based on the WRITE_MODE_A and WRITE_MODE_B settings.

WRITE_MODE_A=NO_CHANGE and WRITE_MODE_B=NO_CHANGE

WEA	WEB	CLKA	CLKB	DIA	DIB	DIPA	DIPB	DOA	DOB	DOPA	DOPB	Data RAM	Parity Ram
0	0	↑	↑	DIA	DIB	DIPA	DIPB	RAM	RAM	RAM	RAM	No Change	No Change
1	0	↑	↑	DIA	DIB	DIPA	DIPB	No Change	X	No Change	X	DIA	DIPA
0	1	↑	↑	DIA	DIB	DIPA	DIPB	X	No Change	X	No Change	DIB	DIPB
1	1	↑	↑	DIA	DIB	DIPA	DIPB	No Change	No Change	No Change	No Change	X	X

WRITE_MODE_A=READ_FIRST and WRITE_MODE_B=READ_FIRST

WEA	WEB	CLKA	CLKB	DIA	DIB	DIPA	DIPB	DOA	DOB	DOPA	DOPB	Data RAM	Parity Ram
0	0	↑	↑	DIA	DIB	DIPA	DIPB	RAM	RAM	RAM	RAM	No Change	No Change
1	0	↑	↑	DIA	DIB	DIPA	DIPB	RAM	RAM	RAM	RAM	DIA	DIPA

WEA	WEB	CLKA	CLKB	DIA	DIB	DIPA	DIPB	DOA	DOB	DOPA	DOPB	Data RAM	Parity Ram
0	1	↑	↑	DIA	DIB	DIPA	DIPB	RAM	RAM	RAM	RAM	DIB	DIPB
1	1	↑	↑	DIA	DIB	DIPA	DIPB	RAM	RAM	RAM	RAM	X	X

WRITE_MODE_A= WRITE_FIRST and WRITE_MODE_B=WRITE_FIRST

WEA	WEB	CLKA	CLKB	DIA	DIB	DIPA	DIPB	DOA	DOB	DOPA	DOPB	Data RAM	Parity Ram
0	0	↑	↑	DIA	DIB	DIPA	DIPB	RAM	RAM	RAM	RAM	No Change	No Change
1	0	↑	↑	DIA	DIB	DIPA	DIPB	DIA	X	DIPA	X	DIA	DIPA
0	1	↑	↑	DIA	DIB	DIPA	DIPB	X	DIB	X	DIPB	DIB	DIPB
1	1	↑	↑	DIA	DIB	DIPA	DIPB	X	X	X	X	X	X

WRITE_MODE_A=NO_CHANGE and WRITE_MODE_B=READ_FIRST

WEA	WEB	CLKA	CLKB	DIA	DIB	DIPA	DIPB	DOA	DOB	DOPA	DOPB	Data RAM	Parity Ram
0	0	↑	↑	DIA	DIB	DIPA	DIPB	RAM	RAM	RAM	RAM	No Change	No Change
1	0	↑	↑	DIA	DIB	DIPA	DIPB	No Change	X	No Change	X	DIA	DIPA
0	1	↑	↑	DIA	DIB	DIPA	DIPB	RAM	RAM	RAM	RAM	DIB	DIPB
1	1	↑	↑	DIA	DIB	DIPA	DIPB	No Change	X	No Change	X	DIB	DIPB

WRITE_MODE_A=NO_CHANGE and WRITE_MODE_B=WRITE_FIRST

WEA	WEB	CLKA	CLKB	DIA	DIB	DIPA	DIPB	DOA	DOB	DOPA	DOPB	Data RAM	Parity Ram
0	0	↑	↑	DIA	DIB	DIPA	DIPB	RAM	RAM	RAM	RAM	No Change	No Change
1	0	↑	↑	DIA	DIB	DIPA	DIPB	No Change	X	No Change	X	DIA	DIPA
0	1	↑	↑	DIA	DIB	DIPA	DIPB	X	DIB	X	DIPB	DIB	DIPB
1	1	↑	↑	DIA	DIB	DIPA	DIPB	No Change	X	No Change	X	X	X

WRITE_MODE_A=READ_FIRST and WRITE_MODE_B=WRITE_FIRST

WEA	WEB	CLKA	CLKB	DIA	DIB	DIPA	DIPB	DOA	DOB	DOPA	DOPB	Data RAM	Parity Ram
0	0	↑	↑	DIA	DIB	DIPA	DIPB	RAM	RAM	RAM	RAM	No Change	No Change
1	0	↑	↑	DIA	DIB	DIPA	DIPB	RAM	RAM	RAM	RAM	DIA	DIPA
0	1	↑	↑	DIA	DIB	DIPA	DIPB	X	DIB	X	DIPB	DIB	DIPB
1	1	↑	↑	DIA	DIB	DIPA	DIPB	X	DIB	X	DIPB	DIA	DIPA

Design Entry Method

This design element can be used in schematics.

Available Attributes

Attribute	Data Type	Allowed Values	Default	Description
INIT_00 to INIT_3F	Binary/ Hexadecimal	Any	All zeros	Specifies the initial contents of the data portion of the RAM array.
INIT_A	Binary/ Hexadecimal	Any	All zeros	Specifies the initial value of the DOA output port after completing configuration. For Type, the bit width is dependent on the width of the A port of the RAM.
INIT_B	Binary/ Hexadecimal	Any	All zeros	Specifies the initial value of the DOB output port after completing configuration. For Type, the bit width is dependent on the width of the B port of the RAM.
INITP_00 to INITP_07	Binary/ Hexadecimal	Any	All zeros	Specifies the initial contents of the parity portion of the RAM array.
SIM_COLLISION_CHECK	String	"ALL", "WARNING_ONLY", "GENERATE_X_ONLY", "NONE"	"ALL"	<p>Allows modification of the simulation behavior if a memory collision occurs. The output is affected as follows:</p> <ul style="list-style-type: none"> "ALL" - Warning produced and affected outputs/memory location go unknown (X). "WARNING_ONLY" - Warning produced and affected outputs/memory retain last value. "GENERATE_X_ONLY" - No warning. However, affected outputs/memory go unknown (X). "NONE" - No warning and affected outputs/memory retain last value. <p>Note Setting this to a value other than "ALL" can allow problems in the design go unnoticed during simulation. Care should be taken when changing the value of this attribute. Please see the <i>Synthesis and Simulation Design Guide</i> for more information.</p>
SRVAL_A	Binary/ Hexadecimal	Any	All zeros	Sets on a per-bit basis whether the DOA output port sets (goes to a one) or resets (goes to a zero) upon the assertion of the RSTA pin. For Type, the bit width is dependent on the width of the A port of the RAM. Default is all bits reset.
SRVAL_B	Binary/ Hexadecimal	Any	All zeros	Sets on a per-bit basis whether the DOB output port sets (goes to a one) or resets (goes to a zero) upon the assertion of the RSTB pin. For Type, the bit width is dependent on the width of the B port of the RAM. Default is all bits reset.

Attribute	Data Type	Allowed Values	Default	Description
WRITE_MODE_A	String	"WRITE_FIRST", "READ_FIRST", "NO_CHANGE"	"WRITE_FIRST"	<p>Specifies the behavior of the DOA port upon a write command to the port.</p> <ul style="list-style-type: none"> "WRITE_FIRST" - the same port that is written to displays the contents of the written data to the outputs upon completion of the operation. "READ_FIRST" - displays the prior contents of the RAM to the output port prior to writing the new data. "NO_CHANGE" - keeps the previous value on the output port and does not update the output port upon a write command. This is the suggested mode if not using the read data from a particular port of the RAM.
WRITE_MODE_B	String	"WRITE_FIRST", "READ_FIRST", "NO_CHANGE"	"WRITE_FIRST"	<p>Specifies the behavior of the DOB port upon a write command to the port.</p> <ul style="list-style-type: none"> "WRITE_FIRST" - the same port that is written to displays the contents of the written data to the outputs upon completion of the operation. "READ_FIRST" - displays the prior contents of the RAM to the output port prior to writing the new data. "NO_CHANGE" - keeps the previous value on the output port and does not update the output port upon a write command. This is the suggested mode if not using the read data from a particular port of the RAM.

For More Information

- See the [Spartan-3 Generation FPGA User Guide \(UG331\)](#).
- See the [Spartan-3E FPGA Family Data Sheet \(DS312\)](#).

RAMB16_S2_S4

Primitive: 16K-bit Data and 2K-bit Parity Dual-Port Synchronous Block RAM with 2-bit and 4-bit Ports

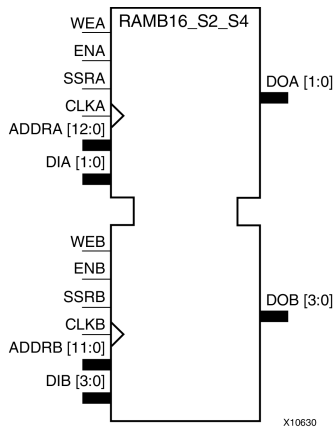

Introduction

This design element is a dual-ported dedicated random access memory block with synchronous write capability. Each block RAM port has 16384 bits of data memory. Ports configured as 9, 18, or 36 bits wide have an additional 2048 bits of parity memory. Each port is independent of the other while accessing the same set of 16384 data memory cells. Each port is independently configured to a specific data width. The possible port and cell configurations for this element are listed in the "Port Descriptions" section.

Logic Table

Truth Table A

Inputs								Outputs			
GSR	ENA	SSRA	WEA	CLKA	ADDR _A	DIA	DIPA	DOA	DOPA	RAM Contents	
										Data RAM	Parity RAM
1	X	X	X	X	X	X	X	INIT _A	INIT _A	No Change	No Change
0	0	X	X	X	X	X	X	No Change	No Change	No Change	No Change
0	1	1	0	↑	X	X	X	SRVAL _A	SRVAL _A	No Change	No Change
0	1	1	1	↑	addr	data	pdata	SRVAL _A	SRVAL _A	RAM(addr) =>data	RAM(addr) =>pdata
0	1	0	0	↑	addr	X	X	RAM(addr)	RAM(addr)	No Change	No Change
0	1	0	1	↑	addr	data	pdata	No Change ¹ , RAM(addr) ² , data ³	No Change ¹ , RAM(addr) ² , pdata ³	RAM(addr) =>data	RAM(addr) =>pdata

GSR=Global Set Reset.

INIT_A=Value specified by the INIT_A attribute for output register. Default is all zeros.

SRVAL_A=register value.

addr=RAM address.

RAM(addr)=RAM contents at address ADDR.

data=RAM input data.

Inputs								Outputs		
GSR	ENA	SSRA	WEA	CLKA	ADDRA	DIA	DIPA	DOA	DOPA	RAM Contents
									Data RAM	Parity RAM
<p>pdata=RAM parity data.</p> <p>¹WRITE_MODE_A=NO_CHANGE.</p> <p>²WRITE_MODE_A=READ_FIRST.</p> <p>³WRITE_MODE_A=WRITE_FIRST.</p>										

Truth Table B

Inputs								Outputs			
GSR	ENB	SSRB	WEB	CLKB	ADDRB	DIB	DIPB	DOB	DOPB	RAM Contents	
										Data RAM	Parity RAM
1	X	X	X	X	X	X	X	INIT_B	INIT_B	No Change	No Change
0	0	X	X	X	X	X	X	No Change	No Change	No Change	No Change
0	1	1	0	↑	X	X	X	SRVAL_B	SRVAL_B	No Change	No Change
0	1	1	1	↑	addr	data	pdata	SRVAL_B	SRVAL_B	RAM(addr) =>data	RAM(addr) =>pdata
0	1	0	0	↑	addr	X	X	RAM(addr)	RAM(addr)	No Change	No Change
0	1	0	1	↑	addr	data	pdata	No Change ¹ , RAM(addr) ² , data ³	No Change ¹ , RAM(addr) ² , pdata ³	RAM(addr) =>data	RAM(addr) =>pdata

GSR=Global Set Reset.
 INIT_B=Value specified by the INIT_B attribute for output registers. Default is all zeros.
 SRVAL_B=register value.
 addr=RAM address.
 RAM(addr)=RAM contents at address ADDR.
 data=RAM input data.
 pdata=RAM parity data.
¹WRITE_MODE_B=NO_CHANGE.
²WRITE_MODE_B=READ_FIRST.
³WRITE_MODE_B=WRITE_FIRST.

Port Descriptions

Port A						Port B				
Design Element	Data Cells ¹	Parity Cells ¹	Address Bus	Data Bus	Parity Bus	Data Cells ¹	Parity Cells ¹	Address Bus	Data Bus	Parity Bus
RAMB16_S2_S4	8192 x 2	-	(12:0)	(1:0)	-	4096 x 4	-	(11:0)	(3:0)	-

¹Depth x Width

Each port is fully synchronous with independent clock pins. All Port A input pins have setup time referenced to the CLKA pin and its data output bus DOA has a clock-to-out time referenced to the CLKA. All Port B input pins have setup time referenced to the CLKB pin and its data output bus DOB has a clock-to-out time referenced to the CLKB. The enable ENA pin controls read, write, and reset for Port A. When ENA is Low, no data is written and the outputs (DOA and DOPA) retain the last state. When ENA is High and reset (SSRA) is High, DOA and DOPA are set to SRVAL_A during the Low-to-High clock (CLKA) transition; if write enable (WEA) is High, the memory contents reflect the data at DIA and DIPA. When ENA is High and WEA is Low, the data stored in the RAM address (ADDRA) is read during the Low-to-High clock transition. By default, WRITE_MODE_A=WRITE_FIRST, when ENA and WEA are High, the data on the data inputs (DIA and DIPA) is loaded into the word selected by the write address (ADDRA) during the Low-to-High clock transition and the data outputs (DOA and DOPA) reflect the selected (addressed) word.

In Spartan®-3A and above devices, each bit in an output register can be initialized at power on (when GSR is high) to either a 0 or 1. In addition, the initial state specified for power on can be different than the state that results from assertion of a set/reset. Four properties control initialization of the output register for a dual-port RAMB16: INIT_A, INIT_B, SRVAL_A, and SRVAL_B. The INIT_A attribute specifies the output register value at power on for Port A and the INIT_B attribute specifies the value for Port B. You can use the SRVAL_A attribute to define the state resulting from assertion of the SSR (set/reset) input on Port A. You can use the SRVAL_B attribute to define the state resulting from assertion of the SSR input on Port B.

The INIT_A, INIT_B, SRVAL_A, and SRVAL_B attributes specify the initialization value as a hexadecimal String. The value is dependent upon the port width. For example, for a RAMB16_S1_S4 with Port A width equal to 1 and Port B width equal to 4, the Port A output register contains 1 bit and the Port B output register contains 4 bits. Therefore, the INIT_A or SRVAL_A value can only be specified as a 1 or 0. For Port B, the output register contains 4 bits. In this case, you can use INIT_B or SRVAL_B to specify a hexadecimal value from 0 through F to initialize the 4 bits of the output register.

For those ports that include parity bits, the parity portion of the output register is specified in the high order bit position of the INIT_A, INIT_B, SRVAL_A, or SRVAL_B value.

The INIT and SRVAL attributes default to zero if they are not set by you.

Write Mode Selection

The WRITE_MODE_A attribute controls the memory and output contents of Port A for a dual-port RAMB16. The WRITE_MODE_B attribute does the same for Port B. By default, both WRITE_MODE_A and WRITE_MODE_B are set to WRITE_FIRST. This means that input is read, written to memory, and then passed to output. You can set the write mode for Port A and Port B to READ_FIRST to read the memory contents, pass the memory contents to the outputs, and then write the input to memory. Or, you can set the write mode to NO_CHANGE to have the input written to memory without changing the output. The Port A and Port B Conflict Resolution section describes how read/write conflicts are resolved when both Port A and Port B are attempting to read/write to the same memory cells.

Port A and Port B Conflict Resolution

Spartan-3A block SelectRAM™ is True Dual-Port RAM that allows both ports to simultaneously access the same memory cell. When one port writes to a given memory cell, the other port must not address that memory cell (for a write or a read) within the clock-to-clock setup window.

The following tables summarize the collision detection behavior of the dual-port RAMB16 based on the WRITE_MODE_A and WRITE_MODE_B settings.

WRITE_MODE_A=NO_CHANGE and WRITE_MODE_B=NO_CHANGE

WEA	WEB	CLKA	CLKB	DIA	DIB	DIPA	DIPB	DOA	DOB	DOPA	DOPB	Data RAM	Parity Ram
0	0	↑	↑	DIA	DIB	DIPA	DIPB	RAM	RAM	RAM	RAM	No Change	No Change
1	0	↑	↑	DIA	DIB	DIPA	DIPB	No Change	X	No Change	X	DIA	DIPA
0	1	↑	↑	DIA	DIB	DIPA	DIPB	X	No Change	X	No Change	DIB	DIPB
1	1	↑	↑	DIA	DIB	DIPA	DIPB	No Change	No Change	No Change	No Change	X	X

WRITE_MODE_A=READ_FIRST and WRITE_MODE_B=READ_FIRST

WEA	WEB	CLKA	CLKB	DIA	DIB	DIPA	DIPB	DOA	DOB	DOPA	DOPB	Data RAM	Parity Ram
0	0	↑	↑	DIA	DIB	DIPA	DIPB	RAM	RAM	RAM	RAM	No Change	No Change
1	0	↑	↑	DIA	DIB	DIPA	DIPB	RAM	RAM	RAM	RAM	DIA	DIPA

WEA	WEB	CLKA	CLKB	DIA	DIB	DIPA	DIPB	DOA	DOB	DOPA	DOPB	Data RAM	Parity Ram
0	1	↑	↑	DIA	DIB	DIPA	DIPB	RAM	RAM	RAM	RAM	DIB	DIPB
1	1	↑	↑	DIA	DIB	DIPA	DIPB	RAM	RAM	RAM	RAM	X	X

WRITE_MODE_A= WRITE_FIRST and WRITE_MODE_B=WRITE_FIRST

WEA	WEB	CLKA	CLKB	DIA	DIB	DIPA	DIPB	DOA	DOB	DOPA	DOPB	Data RAM	Parity Ram
0	0	↑	↑	DIA	DIB	DIPA	DIPB	RAM	RAM	RAM	RAM	No Change	No Change
1	0	↑	↑	DIA	DIB	DIPA	DIPB	DIA	X	DIPA	X	DIA	DIPA
0	1	↑	↑	DIA	DIB	DIPA	DIPB	X	DIB	X	DIPB	DIB	DIPB
1	1	↑	↑	DIA	DIB	DIPA	DIPB	X	X	X	X	X	X

WRITE_MODE_A=NO_CHANGE and WRITE_MODE_B=READ_FIRST

WEA	WEB	CLKA	CLKB	DIA	DIB	DIPA	DIPB	DOA	DOB	DOPA	DOPB	Data RAM	Parity Ram
0	0	↑	↑	DIA	DIB	DIPA	DIPB	RAM	RAM	RAM	RAM	No Change	No Change
1	0	↑	↑	DIA	DIB	DIPA	DIPB	No Change	X	No Change	X	DIA	DIPA
0	1	↑	↑	DIA	DIB	DIPA	DIPB	RAM	RAM	RAM	RAM	DIB	DIPB
1	1	↑	↑	DIA	DIB	DIPA	DIPB	No Change	X	No Change	X	DIB	DIPB

WRITE_MODE_A=NO_CHANGE and WRITE_MODE_B=WRITE_FIRST

WEA	WEB	CLKA	CLKB	DIA	DIB	DIPA	DIPB	DOA	DOB	DOPA	DOPB	Data RAM	Parity Ram
0	0	↑	↑	DIA	DIB	DIPA	DIPB	RAM	RAM	RAM	RAM	No Change	No Change
1	0	↑	↑	DIA	DIB	DIPA	DIPB	No Change	X	No Change	X	DIA	DIPA
0	1	↑	↑	DIA	DIB	DIPA	DIPB	X	DIB	X	DIPB	DIB	DIPB
1	1	↑	↑	DIA	DIB	DIPA	DIPB	No Change	X	No Change	X	X	X

WRITE_MODE_A=READ_FIRST and WRITE_MODE_B=WRITE_FIRST

WEA	WEB	CLKA	CLKB	DIA	DIB	DIPA	DIPB	DOA	DOB	DOPA	DOPB	Data RAM	Parity Ram
0	0	↑	↑	DIA	DIB	DIPA	DIPB	RAM	RAM	RAM	RAM	No Change	No Change
1	0	↑	↑	DIA	DIB	DIPA	DIPB	RAM	RAM	RAM	RAM	DIA	DIPA
0	1	↑	↑	DIA	DIB	DIPA	DIPB	X	DIB	X	DIPB	DIB	DIPB
1	1	↑	↑	DIA	DIB	DIPA	DIPB	X	DIB	X	DIPB	DIA	DIPA

Design Entry Method

This design element can be used in schematics.

Available Attributes

Attribute	Data Type	Allowed Values	Default	Description
INIT_00 to INIT_3F	Binary/ Hexadecimal	Any	All zeros	Specifies the initial contents of the data portion of the RAM array.
INIT_A	Binary/ Hexadecimal	Any	All zeros	Specifies the initial value of the DOA output port after completing configuration. For Type, the bit width is dependent on the width of the A port of the RAM.
INIT_B	Binary/ Hexadecimal	Any	All zeros	Specifies the initial value of the DOB output port after completing configuration. For Type, the bit width is dependent on the width of the B port of the RAM.
INITP_00 to INITP_07	Binary/ Hexadecimal	Any	All zeros	Specifies the initial contents of the parity portion of the RAM array.
SIM_COLLISION_CHECK	String	"ALL", "WARNING_ONLY", "GENERATE_X_ONLY", "NONE"	"ALL"	<p>Allows modification of the simulation behavior if a memory collision occurs. The output is affected as follows:</p> <ul style="list-style-type: none"> "ALL" - Warning produced and affected outputs/memory location go unknown (X). "WARNING_ONLY" - Warning produced and affected outputs/memory retain last value. "GENERATE_X_ONLY" - No warning. However, affected outputs/memory go unknown (X). "NONE" - No warning and affected outputs/memory retain last value. <p>Note Setting this to a value other than "ALL" can allow problems in the design go unnoticed during simulation. Care should be taken when changing the value of this attribute. Please see the <i>Synthesis and Simulation Design Guide</i> for more information.</p>
SRVAL_A	Binary/ Hexadecimal	Any	All zeros	Sets on a per-bit basis whether the DOA output port sets (goes to a one) or resets (goes to a zero) upon the assertion of the RSTA pin. For Type, the bit width is dependent on the width of the A port of the RAM. Default is all bits reset.
SRVAL_B	Binary/ Hexadecimal	Any	All zeros	Sets on a per-bit basis whether the DOB output port sets (goes to a one) or resets (goes to a zero) upon the assertion of the RSTB pin. For Type, the bit width is dependent on the width of the B port of the RAM. Default is all bits reset.

Attribute	Data Type	Allowed Values	Default	Description
WRITE_MODE_A	String	"WRITE_FIRST", "READ_FIRST", "NO_CHANGE"	"WRITE_FIRST"	<p>Specifies the behavior of the DOA port upon a write command to the port.</p> <ul style="list-style-type: none"> "WRITE_FIRST" - the same port that is written to displays the contents of the written data to the outputs upon completion of the operation. "READ_FIRST" - displays the prior contents of the RAM to the output port prior to writing the new data. "NO_CHANGE" - keeps the previous value on the output port and does not update the output port upon a write command. This is the suggested mode if not using the read data from a particular port of the RAM.
WRITE_MODE_B	String	"WRITE_FIRST", "READ_FIRST", "NO_CHANGE"	"WRITE_FIRST"	<p>Specifies the behavior of the DOB port upon a write command to the port.</p> <ul style="list-style-type: none"> "WRITE_FIRST" - the same port that is written to displays the contents of the written data to the outputs upon completion of the operation. "READ_FIRST" - displays the prior contents of the RAM to the output port prior to writing the new data. "NO_CHANGE" - keeps the previous value on the output port and does not update the output port upon a write command. This is the suggested mode if not using the read data from a particular port of the RAM.

For More Information

- See the [Spartan-3 Generation FPGA User Guide \(UG331\)](#).
- See the [Spartan-3E FPGA Family Data Sheet \(DS312\)](#).

RAMB16_S2_S9

Primitive: 16K-bit Data and 2K-bit Parity Dual-Port Synchronous Block RAM with 2-bit and 9-bit Ports

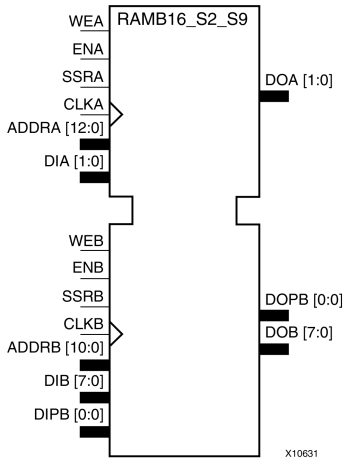

Introduction

This design element is a dual-ported dedicated random access memory block with synchronous write capability. Each block RAM port has 16384 bits of data memory. Ports configured as 9, 18, or 36 bits wide have an additional 2048 bits of parity memory. Each port is independent of the other while accessing the same set of 16384 data memory cells. Each port is independently configured to a specific data width. The possible port and cell configurations for this element are listed in the "Port Descriptions" section.

Logic Table

Truth Table A

Inputs								Outputs			
GSR	ENA	SSRA	WEA	CLKA	ADDRA	DIA	DIPA	DOA	DOPA	RAM Contents	
										Data RAM	Parity RAM
1	X	X	X	X	X	X	X	INIT_A	INIT_A	No Change	No Change
0	0	X	X	X	X	X	X	No Change	No Change	No Change	No Change
0	1	1	0	↑	X	X	X	SRVAL_A	SRVAL_A	No Change	No Change
0	1	1	1	↑	addr	data	pdata	SRVAL_A	SRVAL_A	RAM(addr) =>data	RAM(addr) =>pdata
0	1	0	0	↑	addr	X	X	RAM(addr)	RAM(addr)	No Change	No Change
0	1	0	1	↑	addr	data	pdata	No Change ¹ , RAM(addr) ² , data ³	No Change ¹ , RAM(addr) ² , pdata ³	RAM(addr) =>data	RAM(addr) =>pdata

GSR=Global Set Reset.

INIT_A=Value specified by the INIT_A attribute for output register. Default is all zeros.

SRVAL_A=register value.

addr=RAM address.

RAM(addr)=RAM contents at address ADDR.

Inputs								Outputs			
GSR	ENA	SSRA	WEA	CLKA	ADDRA	DIA	DIPA	DOA	DOPA	RAM Contents	
									Data RAM	Parity RAM	
<p>data=RAM input data. pdata=RAM parity data. ¹WRITE_MODE_A=NO_CHANGE. ²WRITE_MODE_A=READ_FIRST. ³WRITE_MODE_A=WRITE_FIRST.</p>											

Truth Table B

Inputs								Outputs			
GSR	ENB	SSRB	WEB	CLKB	ADDRB	DIB	DIPB	DOB	DOPB	RAM Contents	
										Data RAM	Parity RAM
1	X	X	X	X	X	X	X	INIT_B	INIT_B	No Change	No Change
0	0	X	X	X	X	X	X	No Change	No Change	No Change	No Change
0	1	1	0	↑	X	X	X	SRVAL_B	SRVAL_B	No Change	No Change
0	1	1	1	↑	addr	data	pdata	SRVAL_B	SRVAL_B	RAM(addr) =>data	RAM(addr) =>pdata
0	1	0	0	↑	addr	X	X	RAM(addr)	RAM(addr)	No Change	No Change
0	1	0	1	↑	addr	data	pdata	No Change ¹ , RAM(addr) ² , data ³	No Change ¹ , RAM(addr) ² , pdata ³	RAM(addr) =>data	RAM(addr) =>pdata

GSR=Global Set Reset.
 INIT_B=Value specified by the INIT_B attribute for output registers. Default is all zeros.
 SRVAL_B=register value.
 addr=RAM address.
 RAM(addr)=RAM contents at address ADDR.
 data=RAM input data.
 pdata=RAM parity data.
¹WRITE_MODE_B=NO_CHANGE.
²WRITE_MODE_B=READ_FIRST.
³WRITE_MODE_B=WRITE_FIRST.

Port Descriptions

Port A						Port B				
Design Element	Data Cells ¹	Parity Cells ¹	Address Bus	Data Bus	Parity Bus	Data Cells ¹	Parity Cells ¹	Address Bus	Data Bus	Parity Bus
RAMB16_S2_S9	8192 x 2	-	(12:0)	(1:0)	-	2048 x 8	2048 x 1	(10:0)	(7:0)	(0:0)

¹Depth x Width

Each port is fully synchronous with independent clock pins. All Port A input pins have setup time referenced to the CLKA pin and its data output bus DOA has a clock-to-out time referenced to the CLKA. All Port B input pins have setup time referenced to the CLKB pin and its data output bus DOB has a clock-to-out time referenced to the CLKB. The enable ENA pin controls read, write, and reset for Port A. When ENA is Low, no data is written and the outputs (DOA and DOPA) retain the last state. When ENA is High and reset (SSRA) is High, DOA and DOPA are set to SRVAL_A during the Low-to-High clock (CLKA) transition; if write enable (WEA) is High, the memory contents reflect the data at DIA and DIPA. When ENA is High and WEA is Low, the data stored in the RAM address (ADDRA) is read during the Low-to-High clock transition. By default, WRITE_MODE_A=WRITE_FIRST, when ENA and WEA are High, the data on the data inputs (DIA and DIPA) is loaded into the word selected by the write address (ADDRA) during the Low-to-High clock transition and the data outputs (DOA and DOPA) reflect the selected (addressed) word.

In Spartan®-3A and above devices, each bit in an output register can be initialized at power on (when GSR is high) to either a 0 or 1. In addition, the initial state specified for power on can be different than the state that results from assertion of a set/reset. Four properties control initialization of the output register for a dual-port RAMB16: INIT_A, INIT_B, SRVAL_A, and SRVAL_B. The INIT_A attribute specifies the output register value at power on for Port A and the INIT_B attribute specifies the value for Port B. You can use the SRVAL_A attribute to define the state resulting from assertion of the SSR (set/reset) input on Port A. You can use the SRVAL_B attribute to define the state resulting from assertion of the SSR input on Port B.

The INIT_A, INIT_B, SRVAL_A, and SRVAL_B attributes specify the initialization value as a hexadecimal String. The value is dependent upon the port width. For example, for a RAMB16_S1_S4 with Port A width equal to 1 and Port B width equal to 4, the Port A output register contains 1 bit and the Port B output register contains 4 bits. Therefore, the INIT_A or SRVAL_A value can only be specified as a 1 or 0. For Port B, the output register contains 4 bits. In this case, you can use INIT_B or SRVAL_B to specify a hexadecimal value from 0 through F to initialize the 4 bits of the output register.

For those ports that include parity bits, the parity portion of the output register is specified in the high order bit position of the INIT_A, INIT_B, SRVAL_A, or SRVAL_B value.

The INIT and SRVAL attributes default to zero if they are not set by you.

Write Mode Selection

The WRITE_MODE_A attribute controls the memory and output contents of Port A for a dual-port RAMB16. The WRITE_MODE_B attribute does the same for Port B. By default, both WRITE_MODE_A and WRITE_MODE_B are set to WRITE_FIRST. This means that input is read, written to memory, and then passed to output. You can set the write mode for Port A and Port B to READ_FIRST to read the memory contents, pass the memory contents to the outputs, and then write the input to memory. Or, you can set the write mode to NO_CHANGE to have the input written to memory without changing the output. The Port A and Port B Conflict Resolution section describes how read/write conflicts are resolved when both Port A and Port B are attempting to read/write to the same memory cells.

Port A and Port B Conflict Resolution

Spartan®-3A block SelectRAM™ is True Dual-Port RAM that allows both ports to simultaneously access the same memory cell. When one port writes to a given memory cell, the other port must not address that memory cell (for a write or a read) within the clock-to-clock setup window.

The following tables summarize the collision detection behavior of the dual-port RAMB16 based on the WRITE_MODE_A and WRITE_MODE_B settings.

WRITE_MODE_A=NO_CHANGE and WRITE_MODE_B=NO_CHANGE

WEA	WEB	CLKA	CLKB	DIA	DIB	DIPA	DIPB	DOA	DOB	DOPA	DOPB	Data RAM	Parity Ram
0	0	↑	↑	DIA	DIB	DIPA	DIPB	RAM	RAM	RAM	RAM	No Change	No Change
1	0	↑	↑	DIA	DIB	DIPA	DIPB	No Change	X	No Change	X	DIA	DIPA
0	1	↑	↑	DIA	DIB	DIPA	DIPB	X	No Change	X	No Change	DIB	DIPB
1	1	↑	↑	DIA	DIB	DIPA	DIPB	No Change	No Change	No Change	No Change	X	X

WRITE_MODE_A=READ_FIRST and WRITE_MODE_B=READ_FIRST

WEA	WEB	CLKA	CLKB	DIA	DIB	DIPA	DIPB	DOA	DOB	DOPA	DOPB	Data RAM	Parity Ram
0	0	↑	↑	DIA	DIB	DIPA	DIPB	RAM	RAM	RAM	RAM	No Change	No Change
1	0	↑	↑	DIA	DIB	DIPA	DIPB	RAM	RAM	RAM	RAM	DIA	DIPA

WEA	WEB	CLKA	CLKB	DIA	DIB	DIPA	DIPB	DOA	DOB	DOPA	DOPB	Data RAM	Parity Ram
0	1	↑	↑	DIA	DIB	DIPA	DIPB	RAM	RAM	RAM	RAM	DIB	DIPB
1	1	↑	↑	DIA	DIB	DIPA	DIPB	RAM	RAM	RAM	RAM	X	X

WRITE_MODE_A= WRITE_FIRST and WRITE_MODE_B=WRITE_FIRST

WEA	WEB	CLKA	CLKB	DIA	DIB	DIPA	DIPB	DOA	DOB	DOPA	DOPB	Data RAM	Parity Ram
0	0	↑	↑	DIA	DIB	DIPA	DIPB	RAM	RAM	RAM	RAM	No Change	No Change
1	0	↑	↑	DIA	DIB	DIPA	DIPB	DIA	X	DIPA	X	DIA	DIPA
0	1	↑	↑	DIA	DIB	DIPA	DIPB	X	DIB	X	DIPB	DIB	DIPB
1	1	↑	↑	DIA	DIB	DIPA	DIPB	X	X	X	X	X	X

WRITE_MODE_A=NO_CHANGE and WRITE_MODE_B=READ_FIRST

WEA	WEB	CLKA	CLKB	DIA	DIB	DIPA	DIPB	DOA	DOB	DOPA	DOPB	Data RAM	Parity Ram
0	0	↑	↑	DIA	DIB	DIPA	DIPB	RAM	RAM	RAM	RAM	No Change	No Change
1	0	↑	↑	DIA	DIB	DIPA	DIPB	No Change	X	No Change	X	DIA	DIPA
0	1	↑	↑	DIA	DIB	DIPA	DIPB	RAM	RAM	RAM	RAM	DIB	DIPB
1	1	↑	↑	DIA	DIB	DIPA	DIPB	No Change	X	No Change	X	DIB	DIPB

WRITE_MODE_A=NO_CHANGE and WRITE_MODE_B=WRITE_FIRST

WEA	WEB	CLKA	CLKB	DIA	DIB	DIPA	DIPB	DOA	DOB	DOPA	DOPB	Data RAM	Parity Ram
0	0	↑	↑	DIA	DIB	DIPA	DIPB	RAM	RAM	RAM	RAM	No Change	No Change
1	0	↑	↑	DIA	DIB	DIPA	DIPB	No Change	X	No Change	X	DIA	DIPA
0	1	↑	↑	DIA	DIB	DIPA	DIPB	X	DIB	X	DIPB	DIB	DIPB
1	1	↑	↑	DIA	DIB	DIPA	DIPB	No Change	X	No Change	X	X	X

WRITE_MODE_A=READ_FIRST and WRITE_MODE_B=WRITE_FIRST

WEA	WEB	CLKA	CLKB	DIA	DIB	DIPA	DIPB	DOA	DOB	DOPA	DOPB	Data RAM	Parity Ram
0	0	↑	↑	DIA	DIB	DIPA	DIPB	RAM	RAM	RAM	RAM	No Change	No Change
1	0	↑	↑	DIA	DIB	DIPA	DIPB	RAM	RAM	RAM	RAM	DIA	DIPA
0	1	↑	↑	DIA	DIB	DIPA	DIPB	X	DIB	X	DIPB	DIB	DIPB
1	1	↑	↑	DIA	DIB	DIPA	DIPB	X	DIB	X	DIPB	DIA	DIPA

Design Entry Method

This design element can be used in schematics.

Available Attributes

Attribute	Data Type	Allowed Values	Default	Description
INIT_00 to INIT_3F	Binary/ Hexadecimal	Any	All zeros	Specifies the initial contents of the data portion of the RAM array.
INIT_A	Binary/ Hexadecimal	Any	All zeros	Specifies the initial value of the DOA output port after completing configuration. For Type, the bit width is dependent on the width of the A port of the RAM.
INIT_B	Binary/ Hexadecimal	Any	All zeros	Specifies the initial value of the DOB output port after completing configuration. For Type, the bit width is dependent on the width of the B port of the RAM.
INITP_00 to INITP_07	Binary/ Hexadecimal	Any	All zeros	Specifies the initial contents of the parity portion of the RAM array.
SIM_COLLISION_CHECK	String	"ALL", "WARNING_ONLY", "GENERATE_X_ONLY", "NONE"	"ALL"	<p>Allows modification of the simulation behavior if a memory collision occurs. The output is affected as follows:</p> <ul style="list-style-type: none"> "ALL" - Warning produced and affected outputs/memory location go unknown (X). "WARNING_ONLY" - Warning produced and affected outputs/memory retain last value. "GENERATE_X_ONLY" - No warning. However, affected outputs/memory go unknown (X). "NONE" - No warning and affected outputs/memory retain last value. <p>Note Setting this to a value other than "ALL" can allow problems in the design go unnoticed during simulation. Care should be taken when changing the value of this attribute. Please see the <i>Synthesis and Simulation Design Guide</i> for more information.</p>
SRVAL_A	Binary/ Hexadecimal	Any	All zeros	Sets on a per-bit basis whether the DOA output port sets (goes to a one) or resets (goes to a zero) upon the assertion of the RSTA pin. For Type, the bit width is dependent on the width of the A port of the RAM. Default is all bits reset.
SRVAL_B	Binary/ Hexadecimal	Any	All zeros	Sets on a per-bit basis whether the DOB output port sets (goes to a one) or resets (goes to a zero) upon the assertion of the RSTB pin. For Type, the bit width is dependent on the width of the B port of the RAM. Default is all bits reset.

Attribute	Data Type	Allowed Values	Default	Description
WRITE_MODE_A	String	"WRITE_FIRST", "READ_FIRST", "NO_CHANGE"	"WRITE_FIRST"	<p>Specifies the behavior of the DOA port upon a write command to the port.</p> <ul style="list-style-type: none"> "WRITE_FIRST" - the same port that is written to displays the contents of the written data to the outputs upon completion of the operation. "READ_FIRST" - displays the prior contents of the RAM to the output port prior to writing the new data. "NO_CHANGE" - keeps the previous value on the output port and does not update the output port upon a write command. This is the suggested mode if not using the read data from a particular port of the RAM.
WRITE_MODE_B	String	"WRITE_FIRST", "READ_FIRST", "NO_CHANGE"	"WRITE_FIRST"	<p>Specifies the behavior of the DOB port upon a write command to the port.</p> <ul style="list-style-type: none"> "WRITE_FIRST" - the same port that is written to displays the contents of the written data to the outputs upon completion of the operation. "READ_FIRST" - displays the prior contents of the RAM to the output port prior to writing the new data. "NO_CHANGE" - keeps the previous value on the output port and does not update the output port upon a write command. This is the suggested mode if not using the read data from a particular port of the RAM.

For More Information

- See the [Spartan-3 Generation FPGA User Guide \(UG331\)](#).
- See the [Spartan-3E FPGA Family Data Sheet \(DS312\)](#).

RAMB16_S36

Primitive: 16K-bit Data and 2K-bit Parity Single-Port Synchronous Block RAM with 36-bit Port

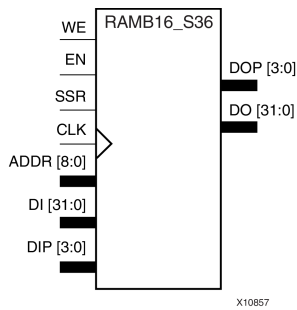

Introduction

This design element is a dedicated random access memory block with synchronous write capability. The block RAM port has 16384 bits of data memory. The cell configuration for this element is listed in the following table.

Data Cells		Parity Cells				
Depth	Width	Depth	Width	Address Bus	Data Bus	Parity Bus
512	32	512	4	(8:0)	(31:0)	(3:0)

The enable EN pin controls read, write, and reset. When EN is Low, no data is written and the outputs (DO and DOP) retain the last state. When EN is High and reset (SSR) is High, DO and DOP are set to SRVAL during the Low-to-High clock (CLK) transition; if write enable (WE) is High, the memory contents reflect the data at DI and DIP. When EN is High and WE is Low, the data stored in the RAM address (ADDR) is read during the Low-to-High clock transition. By default, WRITE_MODE=WRITE_FIRST, when EN and WE are High, the data on the data inputs (DI and DIP) is loaded into the word selected by the write address (ADDR) during the Low-to-High clock transition and the data outputs (DO and DOP) reflect the selected (addressed) word.

The above description assumes an active High EN, WE, SSR, and CLK. However, the active level can be changed by placing an inverter on the port. Any inverter placed on a RAMB16 port is absorbed into the block and does not use a CLB resource.

Logic Table

Inputs								Outputs			
GSR	EN	SSR	WE	CLK	ADDR	DI	DIP	DO	DOP	RAM Contents	
										Data RAM	Parity RAM
1	X	X	X	X	X	X	X	INIT	INIT	No Change	No Change
0	0	X	X	X	X	X	X	No Change	No Change	No Change	No Change
0	1	1	0	↑	X	X	X	SRVAL	SRVAL	No Change	No Change
0	1	1	1	↑	addr	data	pdata	SRVAL	SRVAL	RAM(addr) =>data	RAM(addr) =>pdata
0	1	0	0	↑	addr	X	X	RAM (addr)	RAM (addr)	No Change	No Change
0	1	0	1	↑	addr	data	pdata	No Change ¹ RAM	No Change ¹ RAM	RAM (addr)=>data	RAM (addr)=>pdata

Inputs								Outputs			
GSR	EN	SSR	WE	CLK	ADDR	DI	DIP	DO	DOP	RAM Contents	
										Data RAM	Parity RAM
								(addr) ² data ³	(addr) ² pdata ³		
<p>GSR=Global Set Reset signal</p> <p>INIT=Value specified by the INIT attribute for data memory. Default is all zeros.</p> <p>SRVAL=Value after assertion of SSR as specified by the SRVAL attribute.</p> <p>addr=RAM address.</p> <p>RAM(addr)=RAM contents at address ADDR.</p> <p>data=RAM input data.</p> <p>pdata=RAM parity data.</p> <p>¹WRITE_MODE=NO_CHANGE</p> <p>²WRITE_MODE=READ_FIRST</p> <p>³WRITE_MODE=WRITE_FIRST</p>											

Initialization

Initializing Memory Contents

You can use the INIT_xx attributes to specify an initialization value for the memory contents of a RAMB16 during device configuration. The initialization of each RAMB16 is set by 64 initialization attributes (INIT_00 through INIT_3F) of 64 hex values for a total of 16384 bits.

You can use the INITP_xx attributes to specify an initial value for the parity memory during device configuration or assertion. The initialization of the parity memory for ports configured for 9, 18, or 36 bits is set by 8 initialization attributes (INITP_00 through INITP_07) of 64 hex values for a total of 2048 bits.

Any INIT_xx or INITP_xx attribute that is not specified is configured as zeros. Partial Strings are padded with zeros to the left.

Initializing the Output Register

In Spartan®-3A and above devices, each bit in the output register can be initialized at power on to either a 0 or 1. In addition, the initial state specified for power on can be different than the state that results from assertion of a set/reset. Two types of properties control initialization of the output register for a single-port RAMB16: INIT and SRVAL. The INIT attribute specifies the output register value at power on. You can use the SRVAL attribute to define the state resulting from assertion of the SSR (set/reset) input.

The INIT and SRVAL attributes specify the initialization value as a hexadecimal String containing one bit for each bit in the output port. For example, for a RAMB16_S1 with port width equal to 1, the output register contains 1 bit. Therefore, the INIT or SRVAL value can only be specified as a 1 or 0. For RAMB16_S4 with port width equal to 4, the output register contains 4 bits. In this case, you can specify a hexadecimal value from 0 through F to initialize the 4 bits of the output register.

For those ports that include parity bits, the parity portion of the output register is specified in the high order bit position of the INIT or SRVAL value.

Selecting Write Mode

The WRITE_MODE attribute controls RAMB16 memory and output contents. By default, the WRITE_MODE is set to WRITE_FIRST. This means that input is read, written to memory, and then passed to output. You can set the WRITE_MODE to READ_FIRST to read the memory contents, pass the memory contents to the outputs, and then write the input to memory. Or, you can set the WRITE_MODE to NO_CHANGE to have the input written to memory without changing the output.

Design Entry Method

This design element can be used in schematics.

Available Attributes

Attribute	Data Type	Allowed Values	Default	Description
INIT	Binary/ Hexadecimal	Any Hex Value	All zeros	Identifies the initial value of the DO output port after completing configuration. The bit width is dependent on the width of the A or B port of the RAM.
INIT_00 to INIT_3F	Binary/ Hexadecimal	Any Hex Value	All zeros	Specifies the initial contents of the data portion of the RAM array.
INITP_00 to INITP_07	Binary/ Hexadecimal	Any Hex Value	All zeros	Specifies the initial contents of the parity portion of the RAM array.
SRVAL	Binary/ Hexadecimal	Any Hex Value	All zeros	Allows the individual selection of whether the DO output port sets (go to a one) or reset (go to a zero) upon the assertion of the SSR pin. The bit width is dependent on the width of the A or B port of the RAM.
WRITE_MODE	String	"WRITE_FIRST", "READ_FIRST" or "NO_CHANGE"	"WRITE_FIRST"	Specifies the behavior of the DO port upon a write command to the respected port. If set to "WRITE_FIRST", the same port that is written to displays the contents of the written data to the outputs upon completion of the operation. "READ_FIRST" displays the prior contents of the RAM to the output port prior to writing the new data. "NO_CHANGE" keeps the previous value on the output port and wont update the output port upon a write command. This is the suggested mode if not using the read data from a particular port of the RAM.

For More Information

- See the [Spartan-3 Generation FPGA User Guide \(UG331\)](#).
- See the [Spartan-3E FPGA Family Data Sheet \(DS312\)](#).

RAMB16_S36_S36

Primitive: 16K-bit Data and 2K-bit Parity Dual-Port Synchronous Block RAM with Two 36-bit Ports

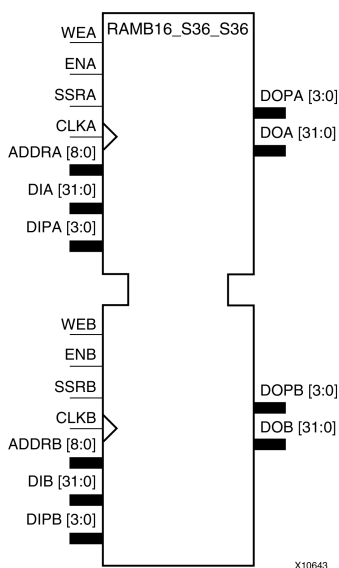

Introduction

This design element is a dual-ported dedicated random access memory block with synchronous write capability. Each block RAM port has 16384 bits of data memory. Ports configured as 9, 18, or 36 bits wide have an additional 2048 bits of parity memory. Each port is independent of the other while accessing the same set of 16384 data memory cells. Each port is independently configured to a specific data width. The possible port and cell configurations for this element are listed in the "Port Descriptions" section.

Logic Table

Truth Table A

Inputs								Outputs			
GSR	ENA	SSRA	WEA	CLKA	ADDRA	DIA	DIPA	DOA	DOPA	RAM Contents	
										Data RAM	Parity RAM
1	X	X	X	X	X	X	X	INIT_A	INIT_A	No Change	No Change
0	0	X	X	X	X	X	X	No Change	No Change	No Change	No Change
0	1	1	0	↑	X	X	X	SRVAL_A	SRVAL_A	No Change	No Change
0	1	1	1	↑	addr	data	pdata	SRVAL_A	SRVAL_A	RAM(addr) =>data	RAM(addr) =>pdata
0	1	0	0	↑	addr	X	X	RAM(addr)	RAM(addr)	No Change	No Change
0	1	0	1	↑	addr	data	pdata	No Change ¹ , RAM(addr) ² , data ³	No Change ¹ , RAM(addr) ² , pdata ³	RAM(addr) =>data	RAM(addr) =>pdata

GSR=Global Set Reset.

INIT_A=Value specified by the INIT_A attribute for output register. Default is all zeros.

SRVAL_A=register value.

addr=RAM address.

RAM(addr)=RAM contents at address ADDR.

data=RAM input data.

pdata=RAM parity data.

¹WRITE_MODE_A=NO_CHANGE.

²WRITE_MODE_A=READ_FIRST.

³WRITE_MODE_A=WRITE_FIRST.

Truth Table B

Inputs								Outputs			
GSR	ENB	SSRB	WEB	CLKB	ADDRB	DIB	DIPB	DOB	DOPB	RAM Contents	
										Data RAM	Parity RAM
1	X	X	X	X	X	X	X	INIT_B	INIT_B	No Change	No Change
0	0	X	X	X	X	X	X	No Change	No Change	No Change	No Change
0	1	1	0	↑	X	X	X	SRVAL_B	SRVAL_B	No Change	No Change
0	1	1	1	↑	addr	data	pdata	SRVAL_B	SRVAL_B	RAM(addr) =>data	RAM(addr) =>pdata
0	1	0	0	↑	addr	X	X	RAM(addr)	RAM(addr)	No Change	No Change
0	1	0	1	↑	addr	data	pdata	No Change ¹ , RAM(addr) ² , data ³	No Change ¹ , RAM(addr) ² , pdata ³	RAM(addr) =>data	RAM(addr) =>pdata

GSR=Global Set Reset.

INIT_B=Value specified by the INIT_B attribute for output registers. Default is all zeros.

SRVAL_B=register value.

addr=RAM address.

RAM(addr)=RAM contents at address ADDR.

data=RAM input data.

pdata=RAM parity data.

¹WRITE_MODE_B=NO_CHANGE.

²WRITE_MODE_B=READ_FIRST.

³WRITE_MODE_B=WRITE_FIRST.

Port Descriptions

Port A						Port B				
Design Element	Data Cells ¹	Parity Cells ¹	Address Bus	Data Bus	Parity Bus	Data Cells ¹	Parity Cells ¹	Address Bus	Data Bus	Parity Bus
RAMB16_S36_S36	512 x 32	512 x 4	(8:0)	(31:0)	(3:0)	512 x 32	512 x 4	(8:0)	(31:0)	(3:0)

¹Depth x Width

Each port is fully synchronous with independent clock pins. All Port A input pins have setup time referenced to the CLKA pin and its data output bus DOA has a clock-to-out time referenced to the CLKA. All Port B input pins have setup time referenced to the CLKB pin and its data output bus DOB has a clock-to-out time referenced to the CLKB. The enable ENA pin controls read, write, and reset for Port A. When ENA is Low, no data is written and the outputs (DOA and DOPA) retain the last state. When ENA is High and reset (SSRA) is High, DOA and DOPA are set to SRVAL_A during the Low-to-High clock (CLKA) transition; if write enable (WEA) is High, the memory contents reflect the data at DIA and DIPA. When ENA is High and WEA is Low, the data stored in the RAM address (ADDRA) is read during the Low-to-High clock transition. By default, WRITE_MODE_A=WRITE_FIRST, when ENA and WEA are High, the data on the data inputs (DIA and DIPA) is loaded into the word selected by the write address (ADDRA) during the Low-to-High clock transition and the data outputs (DOA and DOPA) reflect the selected (addressed) word.

The enable ENB pin controls read, write, and reset for Port B. When ENB is Low, no data is written and the outputs (DOB and DOPB) retain the last state. When ENB is High and reset (SSRB) is High, DOB and DOPB are set to SRVAL_B during the Low-to-High clock (CLKB) transition; if write enable (WEB) is High, the memory contents reflect the data at DIB and DIPB. When ENB is High and WEB is Low, the data stored in the RAM address (ADDRB) is read during the Low-to-High clock transition. By default, WRITE_MODE_B=WRITE_FIRST, when ENB and WEB are High, the data on the data inputs (DIB and PB) are loaded into the word selected by the write address (ADDRB) during the Low-to-High clock transition and the data outputs (DOB and DOPB) reflect the selected (addressed) word. The above descriptions assume active High control pins (ENA, WEA, SSRA, CLKA, ENB, WEB, SSRB, and CLKB). However, the active level can be changed by placing an inverter on the port. Any inverter placed on a RAMB16 port is absorbed into the block and does not use a CLB resource.

Address Mapping

Each port accesses the same set of 18432 memory cells using an addressing scheme that is dependent on the width of the port. For all port widths, 16384 memory cells are available for data as shown in the Port Address Mapping for Data table below. For 9-, 18-, and 36-bit wide ports, 2408 parity memory cells are also available as shown in Port Address Mapping for Parity table below. The physical RAM location that is addressed for a particular width is determined from the following formula.

$$\text{Start} = ((\text{ADDR port} + 1) * (\text{Widthport})) - 1$$

$$\text{End} = (\text{ADDRport}) * (\text{Widthport})$$

The following tables show address mapping for each port width.

Port Address Mapping for Data

Data Width	Port Data Addresses																																					
1	16384	<--	31	30	29	28	27	26	25	24	23	22	21	20	19	18	17	16	15	14	13	12	11	10	9	8	7	6	5	4	3	2	1	0				
2	8192	<--	15	14	13	12	11	10	9	8	7	6	5	4	3	2	1	0																				
4	4096	<--	7			6			5			4			3			2			1			0														
8	2048	<--	3						2					1							0																	
16	1024	<--	1											0																								
32	512	<--	0																																			

Port Address Mapping for Parity

Parity Width	Port Parity Addresses																																					
1	2048	<---	3						2						1																						0	
2	1024	<---	1												0																							
4	512	<---	0																																			

Initializing Memory Contents of a Dual-Port RAMB16

You can use the INIT_xx attributes to specify an initialization value for the memory contents of a RAMB16 during device configuration. The initialization of each RAMB16_Sm_Sn is set by 64 initialization attributes (INIT_00 through INIT_3F) of 64 hex values for a total of 16384 bits.

You can use the INITP_xx attributes to specify an initial value for the parity memory during device configuration or assertion. The initialization of the parity memory for ports configured for 9, 18, or 36 bits is set by 8 initialization attributes (INITP_00 through INITP_07) of 64 hex values for a total of 2048 bits.

If any INIT_xx or INITP_xx attribute is not specified, it is configured as zeros. Partial Strings are padded with zeros to the left.

Initializing the Output Register of a Dual-Port RAMB16

In Spartan®-3A and above devices, each bit in an output register can be initialized at power on (when GSR is high) to either a 0 or 1. In addition, the initial state specified for power on can be different than the state that results from assertion of a set/reset. Four properties control initialization of the output register for a dual-port RAMB16: INIT_A, INIT_B, SRVAL_A, and SRVAL_B. The INIT_A attribute specifies the output register value at power on for Port A and the INIT_B attribute specifies the value for Port B. You can use the SRVAL_A attribute to define the state resulting from assertion of the SSR (set/reset) input on Port A. You can use the SRVAL_B attribute to define the state resulting from assertion of the SSR input on Port B.

The INIT_A, INIT_B, SRVAL_A, and SRVAL_B attributes specify the initialization value as a hexadecimal String. The value is dependent upon the port width. For example, for a RAMB16_S1_S4 with Port A width equal to 1 and Port B width equal to 4, the Port A output register contains 1 bit and the Port B output register contains 4 bits. Therefore, the INIT_A or SRVAL_A value can only be specified as a 1 or 0. For Port B, the output register contains 4 bits. In this case, you can use INIT_B or SRVAL_B to specify a hexadecimal value from 0 through F to initialize the 4 bits of the output register.

For those ports that include parity bits, the parity portion of the output register is specified in the high order bit position of the INIT_A, INIT_B, SRVAL_A, or SRVAL_B value.

The INIT and SRVAL attributes default to zero if they are not set by you.

Write Mode Selection

The WRITE_MODE_A attribute controls the memory and output contents of Port A for a dual-port RAMB16. The WRITE_MODE_B attribute does the same for Port B. By default, both WRITE_MODE_A and WRITE_MODE_B are set to WRITE_FIRST. This means that input is read, written to memory, and then passed to output. You can set the write mode for Port A and Port B to READ_FIRST to read the memory contents, pass the memory contents to the outputs, and then write the input to memory. Or, you can set the write mode to NO_CHANGE to have the input written to memory without changing the output. The Port A and Port B Conflict Resolution section describes how read/write conflicts are resolved when both Port A and Port B are attempting to read/write to the same memory cells.

Port A and Port B Conflict Resolution

Spartan-3A block SelectRAM™ is True Dual-Port RAM that allows both ports to simultaneously access the same memory cell. When one port writes to a given memory cell, the other port must not address that memory cell (for a write or a read) within the clock-to-clock setup window.

The following tables summarize the collision detection behavior of the dual-port RAMB16 based on the WRITE_MODE_A and WRITE_MODE_B settings.

WRITE_MODE_A=NO_CHANGE and WRITE_MODE_B=NO_CHANGE

WEA	WEB	CLKA	CLKB	DIA	DIB	DIPA	DIPB	DOA	DOB	DOPA	DOPB	Data RAM	Parity Ram
0	0	↑	↑	DIA	DIB	DIPA	DIPB	RAM	RAM	RAM	RAM	No Change	No Change
1	0	↑	↑	DIA	DIB	DIPA	DIPB	No Change	X	No Change	X	DIA	DIPA
0	1	↑	↑	DIA	DIB	DIPA	DIPB	X	No Change	X	No Change	DIB	DIPB
1	1	↑	↑	DIA	DIB	DIPA	DIPB	No Change	No Change	No Change	No Change	X	X

WRITE_MODE_A=READ_FIRST and WRITE_MODE_B=READ_FIRST

WEA	WEB	CLKA	CLKB	DIA	DIB	DIPA	DIPB	DOA	DOB	DOPA	DOPB	Data RAM	Parity Ram
0	0	↑	↑	DIA	DIB	DIPA	DIPB	RAM	RAM	RAM	RAM	No Change	No Change
1	0	↑	↑	DIA	DIB	DIPA	DIPB	RAM	RAM	RAM	RAM	DIA	DIPA
0	1	↑	↑	DIA	DIB	DIPA	DIPB	RAM	RAM	RAM	RAM	DIB	DIPB
1	1	↑	↑	DIA	DIB	DIPA	DIPB	RAM	RAM	RAM	RAM	X	X

WRITE_MODE_A= WRITE_FIRST and WRITE_MODE_B=WRITE_FIRST

WEA	WEB	CLKA	CLKB	DIA	DIB	DIPA	DIPB	DOA	DOB	DOPA	DOPB	Data RAM	Parity Ram
0	0	↑	↑	DIA	DIB	DIPA	DIPB	RAM	RAM	RAM	RAM	No Change	No Change
1	0	↑	↑	DIA	DIB	DIPA	DIPB	DIA	X	DIPA	X	DIA	DIPA
0	1	↑	↑	DIA	DIB	DIPA	DIPB	X	DIB	X	DIPB	DIB	DIPB
1	1	↑	↑	DIA	DIB	DIPA	DIPB	X	X	X	X	X	X

WRITE_MODE_A=NO_CHANGE and WRITE_MODE_B=READ_FIRST

WEA	WEB	CLKA	CLKB	DIA	DIB	DIPA	DIPB	DOA	DOB	DOPA	DOPB	Data RAM	Parity Ram
0	0	↑	↑	DIA	DIB	DIPA	DIPB	RAM	RAM	RAM	RAM	No Change	No Change
1	0	↑	↑	DIA	DIB	DIPA	DIPB	No Change	X	No Change	X	DIA	DIPA
0	1	↑	↑	DIA	DIB	DIPA	DIPB	RAM	RAM	RAM	RAM	DIB	DIPB
1	1	↑	↑	DIA	DIB	DIPA	DIPB	No Change	X	No Change	X	DIB	DIPB

WRITE_MODE_A=NO_CHANGE and WRITE_MODE_B=WRITE_FIRST

WEA	WEB	CLKA	CLKB	DIA	DIB	DIPA	DIPB	DOA	DOB	DOPA	DOPB	Data RAM	Parity Ram
0	0	↑	↑	DIA	DIB	DIPA	DIPB	RAM	RAM	RAM	RAM	No Change	No Change
1	0	↑	↑	DIA	DIB	DIPA	DIPB	No Change	X	No Change	X	DIA	DIPA
0	1	↑	↑	DIA	DIB	DIPA	DIPB	X	DIB	X	DIPB	DIB	DIPB
1	1	↑	↑	DIA	DIB	DIPA	DIPB	No Change	X	No Change	X	X	X

WRITE_MODE_A=READ_FIRST and WRITE_MODE_B=WRITE_FIRST

WEA	WEB	CLKA	CLKB	DIA	DIB	DIPA	DIPB	DOA	DOB	DOPA	DOPB	Data RAM	Parity Ram
0	0	↑	↑	DIA	DIB	DIPA	DIPB	RAM	RAM	RAM	RAM	No Change	No Change
1	0	↑	↑	DIA	DIB	DIPA	DIPB	RAM	RAM	RAM	RAM	DIA	DIPA

WEA	WEB	CLKA	CLKB	DIA	DIB	DIPA	DIPB	DOA	DOB	DOPA	DOPB	Data RAM	Parity Ram
0	1	↑	↑	DIA	DIB	DIPA	DIPB	X	DIB	X	DIPB	DIB	DIPB
1	1	↑	↑	DIA	DIB	DIPA	DIPB	X	DIB	X	DIPB	DIA	DIPA

Design Entry Method

This design element can be used in schematics.

Available Attributes

Attribute	Data Type	Allowed Values	Default	Description
INIT_00 to INIT_3F	Binary/ Hexadecimal	Any	All zeros	Specifies the initial contents of the data portion of the RAM array.
INIT_A	Binary/ Hexadecimal	Any	All zeros	Specifies the initial value of the DOA output port after completing configuration. For Type, the bit width is dependent on the width of the A port of the RAM.
INIT_B	Binary/ Hexadecimal	Any	All zeros	Specifies the initial value of the DOB output port after completing configuration. For Type, the bit width is dependent on the width of the B port of the RAM.
INITP_00 to INITP_07	Binary/ Hexadecimal	Any	All zeros	Specifies the initial contents of the parity portion of the RAM array.
SIM_COLLISION_CHECK	String	"ALL", "WARNING_ONLY", "GENERATE_X_ONLY", "NONE"	"ALL"	<p>Allows modification of the simulation behavior if a memory collision occurs. The output is affected as follows:</p> <ul style="list-style-type: none"> "ALL" - Warning produced and affected outputs/memory location go unknown (X). "WARNING_ONLY" - Warning produced and affected outputs/memory retain last value. "GENERATE_X_ONLY" - No warning. However, affected outputs/memory go unknown (X). "NONE" - No warning and affected outputs/memory retain last value. <p>Note Setting this to a value other than "ALL" can allow problems in the design go unnoticed during simulation. Care should be taken when changing the value of this attribute. Please see the <i>Synthesis and Simulation Design Guide</i> for more information.</p>
SRVAL_A	Binary/ Hexadecimal	Any	All zeros	Sets on a per-bit basis whether the DOA output port sets (goes to a one) or resets (goes to a zero) upon the assertion of the RSTA pin. For Type, the bit width is dependent on the width of the A port of the RAM. Default is all bits reset.
SRVAL_B	Binary/ Hexadecimal	Any	All zeros	Sets on a per-bit basis whether the DOB output port sets (goes to a one) or resets (goes to a zero) upon the assertion of the RSTB pin. For Type, the bit width is dependent on the width of the B port of the RAM. Default is all bits reset.

Attribute	Data Type	Allowed Values	Default	Description
WRITE_MODE_A	String	"WRITE_FIRST", "READ_FIRST", "NO_CHANGE"	"WRITE_FIRST"	<p>Specifies the behavior of the DOA port upon a write command to the port.</p> <ul style="list-style-type: none"> "WRITE_FIRST" - the same port that is written to displays the contents of the written data to the outputs upon completion of the operation. "READ_FIRST" - displays the prior contents of the RAM to the output port prior to writing the new data. "NO_CHANGE" - keeps the previous value on the output port and does not update the output port upon a write command. This is the suggested mode if not using the read data from a particular port of the RAM.
WRITE_MODE_B	String	"WRITE_FIRST", "READ_FIRST", "NO_CHANGE"	"WRITE_FIRST"	<p>Specifies the behavior of the DOB port upon a write command to the port.</p> <ul style="list-style-type: none"> "WRITE_FIRST" - the same port that is written to displays the contents of the written data to the outputs upon completion of the operation. "READ_FIRST" - displays the prior contents of the RAM to the output port prior to writing the new data. "NO_CHANGE" - keeps the previous value on the output port and does not update the output port upon a write command. This is the suggested mode if not using the read data from a particular port of the RAM.

For More Information

- See the [Spartan-3 Generation FPGA User Guide \(UG331\)](#).
- See the [Spartan-3E FPGA Family Data Sheet \(DS312\)](#).

RAMB16_S4

Primitive: 16K-bit Data and 2K-bit Parity Single-Port Synchronous Block RAM with 4-bit Port

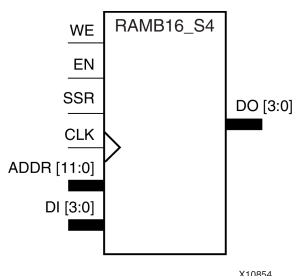

Introduction

This design element is a dedicated random access memory block with synchronous write capability. The block RAM port has 16384 bits of data memory. The cell configuration for this element is listed in the following table.

Data Cells		Parity Cells				
Depth	Width	Depth	Width	Address Bus	Data Bus	Parity Bus
4096	4	-	-	(11:0)	(3:0)	-

The enable EN pin controls read, write, and reset. When EN is Low, no data is written and the outputs (DO and DOP) retain the last state. When EN is High and reset (SSR) is High, DO and DOP are set to SRVAL during the Low-to-High clock (CLK) transition; if write enable (WE) is High, the memory contents reflect the data at DI and DIP. When EN is High and WE is Low, the data stored in the RAM address (ADDR) is read during the Low-to-High clock transition. By default, WRITE_MODE=WRITE_FIRST, when EN and WE are High, the data on the data inputs (DI and DIP) is loaded into the word selected by the write address (ADDR) during the Low-to-High clock transition and the data outputs (DO and DOP) reflect the selected (addressed) word.

The above description assumes an active High EN, WE, SSR, and CLK. However, the active level can be changed by placing an inverter on the port. Any inverter placed on a RAMB16 port is absorbed into the block and does not use a CLB resource.

Logic Table

Inputs								Outputs			
GSR	EN	SSR	WE	CLK	ADDR	DI	DIP	DO	DOP	RAM Contents	
										Data RAM	Parity RAM
1	X	X	X	X	X	X	X	INIT	INIT	No Change	No Change
0	0	X	X	X	X	X	X	No Change	No Change	No Change	No Change
0	1	1	0	↑	X	X	X	SRVAL	SRVAL	No Change	No Change
0	1	1	1	↑	addr	data	pdata	SRVAL	SRVAL	RAM(addr) =>data	RAM(addr) =>pdata
0	1	0	0	↑	addr	X	X	RAM (addr)	RAM (addr)	No Change	No Change
0	1	0	1	↑	addr	data	pdata	No Change ¹ RAM	No Change ¹ RAM	RAM (addr)=>data	RAM (addr)=>pdata

Inputs								Outputs			
GSR	EN	SSR	WE	CLK	ADDR	DI	DIP	DO	DOP	RAM Contents	
										Data RAM	Parity RAM
								(addr) ² data ³	(addr) ² pdata ³		
<p>GSR=Global Set Reset signal</p> <p>INIT=Value specified by the INIT attribute for data memory. Default is all zeros.</p> <p>SRVAL=Value after assertion of SSR as specified by the SRVAL attribute.</p> <p>addr=RAM address.</p> <p>RAM(addr)=RAM contents at address ADDR.</p> <p>data=RAM input data.</p> <p>pdata=RAM parity data.</p> <p>¹WRITE_MODE=NO_CHANGE</p> <p>²WRITE_MODE=READ_FIRST</p> <p>³WRITE_MODE=WRITE_FIRST</p>											

Initialization

Initializing Memory Contents

You can use the INIT_xx attributes to specify an initialization value for the memory contents of a RAMB16 during device configuration. The initialization of each RAMB16 is set by 64 initialization attributes (INIT_00 through INIT_3F) of 64 hex values for a total of 16384 bits.

You can use the INITP_xx attributes to specify an initial value for the parity memory during device configuration or assertion. The initialization of the parity memory for ports configured for 9, 18, or 36 bits is set by 8 initialization attributes (INITP_00 through INITP_07) of 64 hex values for a total of 2048 bits.

Any INIT_xx or INITP_xx attribute that is not specified is configured as zeros. Partial Strings are padded with zeros to the left.

Initializing the Output Register

In Spartan®-3A and above devices, each bit in the output register can be initialized at power on to either a 0 or 1. In addition, the initial state specified for power on can be different than the state that results from assertion of a set/reset. Two types of properties control initialization of the output register for a single-port RAMB16: INIT and SRVAL. The INIT attribute specifies the output register value at power on. You can use the SRVAL attribute to define the state resulting from assertion of the SSR (set/reset) input.

The INIT and SRVAL attributes specify the initialization value as a hexadecimal String containing one bit for each bit in the output port. For example, for a RAMB16_S1 with port width equal to 1, the output register contains 1 bit. Therefore, the INIT or SRVAL value can only be specified as a 1 or 0. For RAMB16_S4 with port width equal to 4, the output register contains 4 bits. In this case, you can specify a hexadecimal value from 0 through F to initialize the 4 bits of the output register.

For those ports that include parity bits, the parity portion of the output register is specified in the high order bit position of the INIT or SRVAL value.

Selecting Write Mode

The WRITE_MODE attribute controls RAMB16 memory and output contents. By default, the WRITE_MODE is set to WRITE_FIRST. This means that input is read, written to memory, and then passed to output. You can set the WRITE_MODE to READ_FIRST to read the memory contents, pass the memory contents to the outputs, and then write the input to memory. Or, you can set the WRITE_MODE to NO_CHANGE to have the input written to memory without changing the output.

Design Entry Method

This design element can be used in schematics.

Available Attributes

Attribute	Data Type	Allowed Values	Default	Description
INIT	Binary/ Hexadecimal	Any Hex Value	All zeros	Identifies the initial value of the DO output port after completing configuration. The bit width is dependent on the width of the A or B port of the RAM.
INIT_00 to INIT_3F	Binary/ Hexadecimal	Any Hex Value	All zeros	Specifies the initial contents of the data portion of the RAM array.
INITP_00 to INITP_07	Binary/ Hexadecimal	Any Hex Value	All zeros	Specifies the initial contents of the parity portion of the RAM array.
SRVAL	Binary/ Hexadecimal	Any Hex Value	All zeros	Allows the individual selection of whether the DO output port sets (go to a one) or reset (go to a zero) upon the assertion of the SSR pin. The bit width is dependent on the width of the A or B port of the RAM.
WRITE_MODE	String	"WRITE_FIRST", "READ_FIRST" or "NO_CHANGE"	"WRITE_FIRST"	Specifies the behavior of the DO port upon a write command to the respected port. If set to "WRITE_FIRST", the same port that is written to displays the contents of the written data to the outputs upon completion of the operation. "READ_FIRST" displays the prior contents of the RAM to the output port prior to writing the new data. "NO_CHANGE" keeps the previous value on the output port and won't update the output port upon a write command. This is the suggested mode if not using the read data from a particular port of the RAM.

For More Information

- See the [Spartan-3 Generation FPGA User Guide \(UG331\)](#).
- See the [Spartan-3E FPGA Family Data Sheet \(DS312\)](#).

RAMB16_S4_S18

Primitive: 16K-bit Data and 2K-bit Parity Dual-Port Synchronous Block RAM with 4-bit and 18-bit Ports

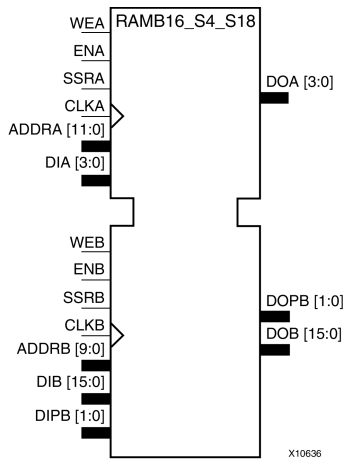

Introduction

This design element is a dual-ported dedicated random access memory block with synchronous write capability. Each block RAM port has 16384 bits of data memory. Ports configured as 9, 18, or 36 bits wide have an additional 2048 bits of parity memory. Each port is independent of the other while accessing the same set of 16384 data memory cells. Each port is independently configured to a specific data width. The possible port and cell configurations for this element are listed in the "Port Descriptions" section.

Logic Table

Truth Table A

Inputs								Outputs			
GSR	ENA	SSRA	WEA	CLKA	ADDR	DIA	DIPA	DOA	DOPA	RAM Contents	
										Data RAM	Parity RAM
1	X	X	X	X	X	X	X	INIT_A	INIT_A	No Change	No Change
0	0	X	X	X	X	X	X	No Change	No Change	No Change	No Change
0	1	1	0	↑	X	X	X	SRVAL_A	SRVAL_A	No Change	No Change
0	1	1	1	↑	addr	data	pdata	SRVAL_A	SRVAL_A	RAM(addr) =>data	RAM(addr) =>pdata
0	1	0	0	↑	addr	X	X	RAM(addr)	RAM(addr)	No Change	No Change
0	1	0	1	↑	addr	data	pdata	No Change ¹ , RAM(addr) ² , data ³	No Change ¹ , RAM(addr) ² , pdata ³	RAM(addr) =>data	RAM(addr) =>pdata

GSR=Global Set Reset.

INIT_A=Value specified by the INIT_A attribute for output register. Default is all zeros.

SRVAL_A=register value.

addr=RAM address.

RAM(addr)=RAM contents at address ADDR.

data=RAM input data.

pdata=RAM parity data.

¹WRITE_MODE_A=NO_CHANGE.

²WRITE_MODE_A=READ_FIRST.

³WRITE_MODE_A=WRITE_FIRST.

Truth Table B

Inputs								Outputs			
GSR	ENB	SSRB	WEB	CLKB	ADDRB	DIB	DIPB	DOB	DOPB	RAM Contents	
										Data RAM	Parity RAM
1	X	X	X	X	X	X	X	INIT_B	INIT_B	No Change	No Change
0	0	X	X	X	X	X	X	No Change	No Change	No Change	No Change
0	1	1	0	↑	X	X	X	SRVAL_B	SRVAL_B	No Change	No Change
0	1	1	1	↑	addr	data	pdata	SRVAL_B	SRVAL_B	RAM(addr) =>data	RAM(addr) =>pdata
0	1	0	0	↑	addr	X	X	RAM(addr)	RAM(addr)	No Change	No Change
0	1	0	1	↑	addr	data	pdata	No Change ¹ , RAM(addr) ² , data ³	No Change ¹ , RAM(addr) ² , pdata ³	RAM(addr) =>data	RAM(addr) =>pdata

GSR=Global Set Reset.
 INIT_B=Value specified by the INIT_B attribute for output registers. Default is all zeros.
 SRVAL_B=register value.
 addr=RAM address.
 RAM(addr)=RAM contents at address ADDR.
 data=RAM input data.
 pdata=RAM parity data.
¹WRITE_MODE_B=NO_CHANGE.
²WRITE_MODE_B=READ_FIRST.
³WRITE_MODE_B=WRITE_FIRST.

Port Descriptions

Port A						Port B				
Design Element	Data Cells ¹	Parity Cells ¹	Address Bus	Data Bus	Parity Bus	Data Cells ¹	Parity Cells ¹	Address Bus	Data Bus	Parity Bus
RAMB16_S4_S18	4096 x 4	-	(11:0)	(3:0)	-	1024 x 16	1024 x 2	(9:0)	(15:0)	(1:0)

¹Depth x Width

Each port is fully synchronous with independent clock pins. All Port A input pins have setup time referenced to the CLKA pin and its data output bus DOA has a clock-to-out time referenced to the CLKA. All Port B input pins have setup time referenced to the CLKB pin and its data output bus DOB has a clock-to-out time referenced to the CLKB. The enable ENA pin controls read, write, and reset for Port A. When ENA is Low, no data is written and the outputs (DOA and DOPA) retain the last state. When ENA is High and reset (SSRA) is High, DOA and DOPA are set to SRVAL_A during the Low-to-High clock (CLKA) transition; if write enable (WEA) is High, the memory contents reflect the data at DIA and DIPA. When ENA is High and WEA is Low, the data stored in the RAM address (ADDR_A) is read during the Low-to-High clock transition. By default, WRITE_MODE_A=WRITE_FIRST, when ENA and WEA are High, the data on the data inputs (DIA and DIPA) is loaded into the word selected by the write address (ADDR_A) during the Low-to-High clock transition and the data outputs (DOA and DOPA) reflect the selected (addressed) word.

The enable ENB pin controls read, write, and reset for Port B. When ENB is Low, no data is written and the outputs (DOB and DOPB) retain the last state. When ENB is High and reset (SSRB) is High, DOB and DOPB are set to SRVAL_B during the Low-to-High clock (CLKB) transition; if write enable (WEB) is High, the memory contents reflect the data at DIB and DIPB. When ENB is High and WEB is Low, the data stored in the RAM address (ADDRB) is read during the Low-to-High clock transition. By default, WRITE_MODE_B=WRITE_FIRST, when ENB and WEB are High, the data on the data inputs (DIB and PB) are loaded into the word selected by the write address (ADDRB) during the Low-to-High clock transition and the data outputs (DOB and DOPB) reflect the selected (addressed) word. The above descriptions assume active High control pins (ENA, WEA, SSRA, CLKA, ENB, WEB, SSRB, and CLKB). However, the active level can be changed by placing an inverter on the port. Any inverter placed on a RAMB16 port is absorbed into the block and does not use a CLB resource.

Address Mapping

Each port accesses the same set of 18432 memory cells using an addressing scheme that is dependent on the width of the port. For all port widths, 16384 memory cells are available for data as shown in the Port Address Mapping for Data table below. For 9-, 18-, and 36-bit wide ports, 2408 parity memory cells are also available as shown in Port Address Mapping for Parity table below. The physical RAM location that is addressed for a particular width is determined from the following formula.

$$\text{Start} = ((\text{ADDR port} + 1) * (\text{Widthport})) - 1$$

$$\text{End} = (\text{ADDRport}) * (\text{Widthport})$$

Port Address Mapping for Data

Data Width	Port Data Addresses																																				
1	16384	<--	31	30	29	28	27	26	25	24	23	22	21	20	19	18	17	16	15	14	13	12	11	10	9	8	7	6	5	4	3	2	1	0			
2	8192	<--	15	14	13	12	11	10	9	8	7	6	5	4	3	2	1	0																			
4	4096	<--	7		6		5		4		3		2		1		0																				
8	2048	<--	3				2				1				0																						
16	1024	<--	1											0																							
32	512	<--	0																																		

Port Address Mapping for Parity

Parity Width	Port Parity Addresses																																				
1	2048	<-----	3						2						1																					0	
2	1024	<-----	1												0																						
4	512	<-----	0																																		

Initializing Memory Contents of a Dual-Port RAMB16

You can use the INIT_xx attributes to specify an initialization value for the memory contents of a RAMB16 during device configuration. The initialization of each RAMB16_Sm_Sn is set by 64 initialization attributes (INIT_00 through INIT_3F) of 64 hex values for a total of 16384 bits.

You can use the INITP_xx attributes to specify an initial value for the parity memory during device configuration or assertion. The initialization of the parity memory for ports configured for 9, 18, or 36 bits is set by 8 initialization attributes (INITP_00 through INITP_07) of 64 hex values for a total of 2048 bits.

If any INIT_xx or INITP_xx attribute is not specified, it is configured as zeros. Partial Strings are padded with zeros to the left.

Initializing the Output Register of a Dual-Port RAMB16

In Spartan®-3A and above devices, each bit in an output register can be initialized at power on (when GSR is high) to either a 0 or 1. In addition, the initial state specified for power on can be different than the state that results from assertion of a set/reset. Four properties control initialization of the output register for a dual-port RAMB16: INIT_A, INIT_B, SRVAL_A, and SRVAL_B. The INIT_A attribute specifies the output register value at power on for Port A and the INIT_B attribute specifies the value for Port B. You can use the SRVAL_A attribute to define the state resulting from assertion of the SSR (set/reset) input on Port A. You can use the SRVAL_B attribute to define the state resulting from assertion of the SSR input on Port B.

The INIT_A, INIT_B, SRVAL_A, and SRVAL_B attributes specify the initialization value as a hexadecimal String. The value is dependent upon the port width. For example, for a RAMB16_S1_S4 with Port A width equal to 1 and Port B width equal to 4, the Port A output register contains 1 bit and the Port B output register contains 4 bits. Therefore, the INIT_A or SRVAL_A value can only be specified as a 1 or 0. For Port B, the output register contains 4 bits. In this case, you can use INIT_B or SRVAL_B to specify a hexadecimal value from 0 through F to initialize the 4 bits of the output register.

For those ports that include parity bits, the parity portion of the output register is specified in the high order bit position of the INIT_A, INIT_B, SRVAL_A, or SRVAL_B value.

The INIT and SRVAL attributes default to zero if they are not set by you.

Write Mode Selection

The WRITE_MODE_A attribute controls the memory and output contents of Port A for a dual-port RAMB16. The WRITE_MODE_B attribute does the same for Port B. By default, both WRITE_MODE_A and WRITE_MODE_B are set to WRITE_FIRST. This means that input is read, written to memory, and then passed to output. You can set the write mode for Port A and Port B to READ_FIRST to read the memory contents, pass the memory contents to the outputs, and then write the input to memory. Or, you can set the write mode to NO_CHANGE to have the input written to memory without changing the output. The Port A and Port B Conflict Resolution section describes how read/write conflicts are resolved when both Port A and Port B are attempting to read/write to the same memory cells.

Port A and Port B Conflict Resolution

Spartan-3A block SelectRAM™ is True Dual-Port RAM that allows both ports to simultaneously access the same memory cell. When one port writes to a given memory cell, the other port must not address that memory cell (for a write or a read) within the clock-to-clock setup window.

The following tables summarize the collision detection behavior of the dual-port RAMB16 based on the WRITE_MODE_A and WRITE_MODE_B settings.

WRITE_MODE_A=NO_CHANGE and WRITE_MODE_B=NO_CHANGE

WEA	WEB	CLKA	CLKB	DIA	DIB	DIPA	DIPB	DOA	DOB	DOPA	DOPB	Data RAM	Parity Ram
0	0	↑	↑	DIA	DIB	DIPA	DIPB	RAM	RAM	RAM	RAM	No Change	No Change
1	0	↑	↑	DIA	DIB	DIPA	DIPB	No Change	X	No Change	X	DIA	DIPA
0	1	↑	↑	DIA	DIB	DIPA	DIPB	X	No Change	X	No Change	DIB	DIPB
1	1	↑	↑	DIA	DIB	DIPA	DIPB	No Change	No Change	No Change	No Change	X	X

WRITE_MODE_A=READ_FIRST and WRITE_MODE_B=READ_FIRST

WEA	WEB	CLKA	CLKB	DIA	DIB	DIPA	DIPB	DOA	DOB	DOPA	DOPB	Data RAM	Parity Ram
0	0	↑	↑	DIA	DIB	DIPA	DIPB	RAM	RAM	RAM	RAM	No Change	No Change
1	0	↑	↑	DIA	DIB	DIPA	DIPB	RAM	RAM	RAM	RAM	DIA	DIPA
0	1	↑	↑	DIA	DIB	DIPA	DIPB	RAM	RAM	RAM	RAM	DIB	DIPB
1	1	↑	↑	DIA	DIB	DIPA	DIPB	RAM	RAM	RAM	RAM	X	X

WRITE_MODE_A= WRITE_FIRST and WRITE_MODE_B=WRITE_FIRST

WEA	WEB	CLKA	CLKB	DIA	DIB	DIPA	DIPB	DOA	DOB	DOPA	DOPB	Data RAM	Parity Ram
0	0	↑	↑	DIA	DIB	DIPA	DIPB	RAM	RAM	RAM	RAM	No Change	No Change
1	0	↑	↑	DIA	DIB	DIPA	DIPB	DIA	X	DIPA	X	DIA	DIPA
0	1	↑	↑	DIA	DIB	DIPA	DIPB	X	DIB	X	DIPB	DIB	DIPB
1	1	↑	↑	DIA	DIB	DIPA	DIPB	X	X	X	X	X	X

WRITE_MODE_A=NO_CHANGE and WRITE_MODE_B=READ_FIRST

WEA	WEB	CLKA	CLKB	DIA	DIB	DIPA	DIPB	DOA	DOB	DOPA	DOPB	Data RAM	Parity Ram
0	0	↑	↑	DIA	DIB	DIPA	DIPB	RAM	RAM	RAM	RAM	No Change	No Change
1	0	↑	↑	DIA	DIB	DIPA	DIPB	No Change	X	No Change	X	DIA	DIPA
0	1	↑	↑	DIA	DIB	DIPA	DIPB	RAM	RAM	RAM	RAM	DIB	DIPB
1	1	↑	↑	DIA	DIB	DIPA	DIPB	No Change	X	No Change	X	DIB	DIPB

WRITE_MODE_A=NO_CHANGE and WRITE_MODE_B=WRITE_FIRST

WEA	WEB	CLKA	CLKB	DIA	DIB	DIPA	DIPB	DOA	DOB	DOPA	DOPB	Data RAM	Parity Ram
0	0	↑	↑	DIA	DIB	DIPA	DIPB	RAM	RAM	RAM	RAM	No Change	No Change
1	0	↑	↑	DIA	DIB	DIPA	DIPB	No Change	X	No Change	X	DIA	DIPA
0	1	↑	↑	DIA	DIB	DIPA	DIPB	X	DIB	X	DIPB	DIB	DIPB
1	1	↑	↑	DIA	DIB	DIPA	DIPB	No Change	X	No Change	X	X	X

WRITE_MODE_A=READ_FIRST and WRITE_MODE_B=WRITE_FIRST

WEA	WEB	CLKA	CLKB	DIA	DIB	DIPA	DIPB	DOA	DOB	DOPA	DOPB	Data RAM	Parity Ram
0	0	↑	↑	DIA	DIB	DIPA	DIPB	RAM	RAM	RAM	RAM	No Change	No Change
1	0	↑	↑	DIA	DIB	DIPA	DIPB	RAM	RAM	RAM	RAM	DIA	DIPA

WEA	WEB	CLKA	CLKB	DIA	DIB	DIPA	DIPB	DOA	DOB	DOPA	DOPB	Data RAM	Parity Ram
0	1	↑	↑	DIA	DIB	DIPA	DIPB	X	DIB	X	DIPB	DIB	DIPB
1	1	↑	↑	DIA	DIB	DIPA	DIPB	X	DIB	X	DIPB	DIA	DIPA

Design Entry Method

This design element can be used in schematics.

Available Attributes

Attribute	Data Type	Allowed Values	Default	Description
INIT_00 to INIT_3F	Binary/Hexadecimal	Any	All zeros	Specifies the initial contents of the data portion of the RAM array.
INIT_A	Binary/Hexadecimal	Any	All zeros	Specifies the initial value of the DOA output port after completing configuration. For Type, the bit width is dependent on the width of the A port of the RAM.
INIT_B	Binary/Hexadecimal	Any	All zeros	Specifies the initial value of the DOB output port after completing configuration. For Type, the bit width is dependent on the width of the B port of the RAM.
INITP_00 to INITP_07	Binary/Hexadecimal	Any	All zeros	Specifies the initial contents of the parity portion of the RAM array.
SIM_COLLISION_CHECK	String	"ALL", "WARNING_ONLY", "GENERATE_X_ONLY", "NONE"	"ALL"	<p>Allows modification of the simulation behavior if a memory collision occurs. The output is affected as follows:</p> <ul style="list-style-type: none"> "ALL" - Warning produced and affected outputs/memory location go unknown (X). "WARNING_ONLY" - Warning produced and affected outputs/memory retain last value. "GENERATE_X_ONLY" - No warning. However, affected outputs/memory go unknown (X). "NONE" - No warning and affected outputs/memory retain last value. <p>Note Setting this to a value other than "ALL" can allow problems in the design go unnoticed during simulation. Care should be taken when changing the value of this attribute. Please see the <i>Synthesis and Simulation Design Guide</i> for more information.</p>
SRVAL_A	Binary/Hexadecimal	Any	All zeros	Sets on a per-bit basis whether the DOA output port sets (goes to a one) or resets (goes to a zero) upon the assertion of the RSTA pin. For Type, the bit width is dependent on the width of the A port of the RAM. Default is all bits reset.
SRVAL_B	Binary/Hexadecimal	Any	All zeros	Sets on a per-bit basis whether the DOB output port sets (goes to a one) or resets (goes to a zero) upon the assertion of the RSTB pin. For Type, the bit width is dependent on the width of the B port of the RAM. Default is all bits reset.

Attribute	Data Type	Allowed Values	Default	Description
WRITE_MODE_A	String	"WRITE_FIRST", "READ_FIRST", "NO_CHANGE"	"WRITE_FIRST"	<p>Specifies the behavior of the DOA port upon a write command to the port.</p> <ul style="list-style-type: none"> "WRITE_FIRST" - the same port that is written to displays the contents of the written data to the outputs upon completion of the operation. "READ_FIRST" - displays the prior contents of the RAM to the output port prior to writing the new data. "NO_CHANGE" - keeps the previous value on the output port and does not update the output port upon a write command. This is the suggested mode if not using the read data from a particular port of the RAM.
WRITE_MODE_B	String	"WRITE_FIRST", "READ_FIRST", "NO_CHANGE"	"WRITE_FIRST"	<p>Specifies the behavior of the DOB port upon a write command to the port.</p> <ul style="list-style-type: none"> "WRITE_FIRST" - the same port that is written to displays the contents of the written data to the outputs upon completion of the operation. "READ_FIRST" - displays the prior contents of the RAM to the output port prior to writing the new data. "NO_CHANGE" - keeps the previous value on the output port and does not update the output port upon a write command. This is the suggested mode if not using the read data from a particular port of the RAM.

For More Information

- See the [Spartan-3 Generation FPGA User Guide \(UG331\)](#).
- See the [Spartan-3E FPGA Family Data Sheet \(DS312\)](#).

RAMB16_S4_S36

Primitive: 16K-bit Data and 2K-bit Parity Dual-Port Synchronous Block RAM with 4-bit and 36-bit Ports

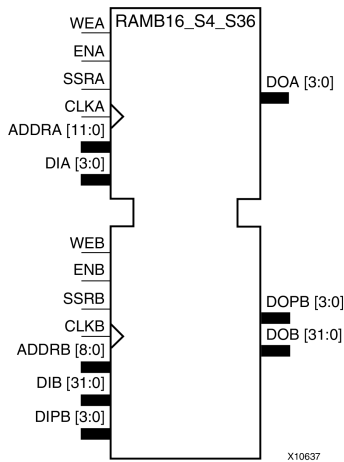

Introduction

This design element is a dual-ported dedicated random access memory block with synchronous write capability. Each block RAM port has 16384 bits of data memory. Ports configured as 9, 18, or 36 bits wide have an additional 2048 bits of parity memory. Each port is independent of the other while accessing the same set of 16384 data memory cells. Each port is independently configured to a specific data width. The possible port and cell configurations for this element are listed in the "Port Descriptions" section.

Logic Table

Truth Table A

Inputs								Outputs			
GSR	ENA	SSRA	WEA	CLKA	ADDR_A	DIA	DIPA	DOA	DOPA	RAM Contents	
										Data RAM	Parity RAM
1	X	X	X	X	X	X	X	INIT_A	INIT_A	No Change	No Change
0	0	X	X	X	X	X	X	No Change	No Change	No Change	No Change
0	1	1	0	↑	X	X	X	SRVAL_A	SRVAL_A	No Change	No Change
0	1	1	1	↑	addr	data	pdata	SRVAL_A	SRVAL_A	RAM(addr) =>data	RAM(addr) =>pdata
0	1	0	0	↑	addr	X	X	RAM(addr)	RAM(addr)	No Change	No Change
0	1	0	1	↑	addr	data	pdata	No Change ¹ , RAM(addr) ² , data ³	No Change ¹ , RAM(addr) ² , pdata ³	RAM(addr) =>data	RAM(addr) =>pdata

GSR=Global Set Reset.

INIT_A=Value specified by the INIT_A attribute for output register. Default is all zeros.

SRVAL_A=register value.

addr=RAM address.

RAM(addr)=RAM contents at address ADDR.

Inputs								Outputs		
GSR	ENA	SSRA	WEA	CLKA	ADDRA	DIA	DIPA	DOA	DOPA	RAM Contents
									Data RAM	Parity RAM
<p>data=RAM input data.</p> <p>pdata=RAM parity data.</p> <p>¹WRITE_MODE_A=NO_CHANGE.</p> <p>²WRITE_MODE_A=READ_FIRST.</p> <p>³WRITE_MODE_A=WRITE_FIRST.</p>										

Truth Table B

Inputs								Outputs			
GSR	ENB	SSRB	WEB	CLKB	ADDRB	DIB	DIPB	DOB	DOPB	RAM Contents	
										Data RAM	Parity RAM
1	X	X	X	X	X	X	X	INIT_B	INIT_B	No Change	No Change
0	0	X	X	X	X	X	X	No Change	No Change	No Change	No Change
0	1	1	0	↑	X	X	X	SRVAL_B	SRVAL_B	No Change	No Change
0	1	1	1	↑	addr	data	pdata	SRVAL_B	SRVAL_B	RAM(addr) =>data	RAM(addr) =>pdata
0	1	0	0	↑	addr	X	X	RAM(addr)	RAM(addr)	No Change	No Change
0	1	0	1	↑	addr	data	pdata	No Change ¹ , RAM(addr) ² , data ³	No Change ¹ , RAM(addr) ² , pdata ³	RAM(addr) =>data	RAM(addr) =>pdata

GSR=Global Set Reset.
 INIT_B=Value specified by the INIT_B attribute for output registers. Default is all zeros.
 SRVAL_B=register value.
 addr=RAM address.
 RAM(addr)=RAM contents at address ADDR.
 data=RAM input data.
 pdata=RAM parity data.
¹WRITE_MODE_B=NO_CHANGE.
²WRITE_MODE_B=READ_FIRST.
³WRITE_MODE_B=WRITE_FIRST.

Port Descriptions

Port A						Port B				
Design Element	Data Cells ¹	Parity Cells ¹	Address Bus	Data Bus	Parity Bus	Data Cells ¹	Parity Cells ¹	Address Bus	Data Bus	Parity Bus
RAMB16_S4_S36	4096 x 4	-	(11:0)	(3:0)	-	512 x 32	512 x 4	(8:0)	(31:0)	(3:0)

¹Depth x Width

Each port is fully synchronous with independent clock pins. All Port A input pins have setup time referenced to the CLKA pin and its data output bus DOA has a clock-to-out time referenced to the CLKA. All Port B input pins have setup time referenced to the CLKB pin and its data output bus DOB has a clock-to-out time referenced to the CLKB. The enable ENA pin controls read, write, and reset for Port A. When ENA is Low, no data is written and the outputs (DOA and DOPA) retain the last state. When ENA is High and reset (SSRA) is High, DOA and DOPA are set to SRVAL_A during the Low-to-High clock (CLKA) transition; if write enable (WEA) is High, the memory contents reflect the data at DIA and DIPA. When ENA is High and WEA is Low, the data stored in the RAM address (ADDRA) is read during the Low-to-High clock transition. By default, WRITE_MODE_A=WRITE_FIRST, when ENA and WEA are High, the data on the data inputs (DIA and DIPA) is loaded into the word selected by the write address (ADDRA) during the Low-to-High clock transition and the data outputs (DOA and DOPA) reflect the selected (addressed) word.

In Spartan®-3A and above devices, each bit in an output register can be initialized at power on (when GSR is high) to either a 0 or 1. In addition, the initial state specified for power on can be different than the state that results from assertion of a set/reset. Four properties control initialization of the output register for a dual-port RAMB16: INIT_A, INIT_B, SRVAL_A, and SRVAL_B. The INIT_A attribute specifies the output register value at power on for Port A and the INIT_B attribute specifies the value for Port B. You can use the SRVAL_A attribute to define the state resulting from assertion of the SSR (set/reset) input on Port A. You can use the SRVAL_B attribute to define the state resulting from assertion of the SSR input on Port B.

The INIT_A, INIT_B, SRVAL_A, and SRVAL_B attributes specify the initialization value as a hexadecimal String. The value is dependent upon the port width. For example, for a RAMB16_S1_S4 with Port A width equal to 1 and Port B width equal to 4, the Port A output register contains 1 bit and the Port B output register contains 4 bits. Therefore, the INIT_A or SRVAL_A value can only be specified as a 1 or 0. For Port B, the output register contains 4 bits. In this case, you can use INIT_B or SRVAL_B to specify a hexadecimal value from 0 through F to initialize the 4 bits of the output register.

For those ports that include parity bits, the parity portion of the output register is specified in the high order bit position of the INIT_A, INIT_B, SRVAL_A, or SRVAL_B value.

The INIT and SRVAL attributes default to zero if they are not set by you.

Write Mode Selection

The WRITE_MODE_A attribute controls the memory and output contents of Port A for a dual-port RAMB16. The WRITE_MODE_B attribute does the same for Port B. By default, both WRITE_MODE_A and WRITE_MODE_B are set to WRITE_FIRST. This means that input is read, written to memory, and then passed to output. You can set the write mode for Port A and Port B to READ_FIRST to read the memory contents, pass the memory contents to the outputs, and then write the input to memory. Or, you can set the write mode to NO_CHANGE to have the input written to memory without changing the output. The Port A and Port B Conflict Resolution section describes how read/write conflicts are resolved when both Port A and Port B are attempting to read/write to the same memory cells.

Port A and Port B Conflict Resolution

Spartan-3A block SelectRAM™ is True Dual-Port RAM that allows both ports to simultaneously access the same memory cell. When one port writes to a given memory cell, the other port must not address that memory cell (for a write or a read) within the clock-to-clock setup window.

The following tables summarize the collision detection behavior of the dual-port RAMB16 based on the WRITE_MODE_A and WRITE_MODE_B settings.

WRITE_MODE_A=NO_CHANGE and WRITE_MODE_B=NO_CHANGE

WEA	WEB	CLKA	CLKB	DIA	DIB	DIPA	DIPB	DOA	DOB	DOPA	DOPB	Data RAM	Parity Ram
0	0	↑	↑	DIA	DIB	DIPA	DIPB	RAM	RAM	RAM	RAM	No Change	No Change
1	0	↑	↑	DIA	DIB	DIPA	DIPB	No Change	X	No Change	X	DIA	DIPA
0	1	↑	↑	DIA	DIB	DIPA	DIPB	X	No Change	X	No Change	DIB	DIPB
1	1	↑	↑	DIA	DIB	DIPA	DIPB	No Change	No Change	No Change	No Change	X	X

WRITE_MODE_A=READ_FIRST and WRITE_MODE_B=READ_FIRST

WEA	WEB	CLKA	CLKB	DIA	DIB	DIPA	DIPB	DOA	DOB	DOPA	DOPB	Data RAM	Parity Ram
0	0	↑	↑	DIA	DIB	DIPA	DIPB	RAM	RAM	RAM	RAM	No Change	No Change
1	0	↑	↑	DIA	DIB	DIPA	DIPB	RAM	RAM	RAM	RAM	DIA	DIPA

WEA	WEB	CLKA	CLKB	DIA	DIB	DIPA	DIPB	DOA	DOB	DOPA	DOPB	Data RAM	Parity Ram
0	1	↑	↑	DIA	DIB	DIPA	DIPB	RAM	RAM	RAM	RAM	DIB	DIPB
1	1	↑	↑	DIA	DIB	DIPA	DIPB	RAM	RAM	RAM	RAM	X	X

WRITE_MODE_A= WRITE_FIRST and WRITE_MODE_B=WRITE_FIRST

WEA	WEB	CLKA	CLKB	DIA	DIB	DIPA	DIPB	DOA	DOB	DOPA	DOPB	Data RAM	Parity Ram
0	0	↑	↑	DIA	DIB	DIPA	DIPB	RAM	RAM	RAM	RAM	No Change	No Change
1	0	↑	↑	DIA	DIB	DIPA	DIPB	DIA	X	DIPA	X	DIA	DIPA
0	1	↑	↑	DIA	DIB	DIPA	DIPB	X	DIB	X	DIPB	DIB	DIPB
1	1	↑	↑	DIA	DIB	DIPA	DIPB	X	X	X	X	X	X

WRITE_MODE_A=NO_CHANGE and WRITE_MODE_B=READ_FIRST

WEA	WEB	CLKA	CLKB	DIA	DIB	DIPA	DIPB	DOA	DOB	DOPA	DOPB	Data RAM	Parity Ram
0	0	↑	↑	DIA	DIB	DIPA	DIPB	RAM	RAM	RAM	RAM	No Change	No Change
1	0	↑	↑	DIA	DIB	DIPA	DIPB	No Change	X	No Change	X	DIA	DIPA
0	1	↑	↑	DIA	DIB	DIPA	DIPB	RAM	RAM	RAM	RAM	DIB	DIPB
1	1	↑	↑	DIA	DIB	DIPA	DIPB	No Change	X	No Change	X	DIB	DIPB

WRITE_MODE_A=NO_CHANGE and WRITE_MODE_B=WRITE_FIRST

WEA	WEB	CLKA	CLKB	DIA	DIB	DIPA	DIPB	DOA	DOB	DOPA	DOPB	Data RAM	Parity Ram
0	0	↑	↑	DIA	DIB	DIPA	DIPB	RAM	RAM	RAM	RAM	No Change	No Change
1	0	↑	↑	DIA	DIB	DIPA	DIPB	No Change	X	No Change	X	DIA	DIPA
0	1	↑	↑	DIA	DIB	DIPA	DIPB	X	DIB	X	DIPB	DIB	DIPB
1	1	↑	↑	DIA	DIB	DIPA	DIPB	No Change	X	No Change	X	X	X

WRITE_MODE_A=READ_FIRST and WRITE_MODE_B=WRITE_FIRST

WEA	WEB	CLKA	CLKB	DIA	DIB	DIPA	DIPB	DOA	DOB	DOPA	DOPB	Data RAM	Parity Ram
0	0	↑	↑	DIA	DIB	DIPA	DIPB	RAM	RAM	RAM	RAM	No Change	No Change
1	0	↑	↑	DIA	DIB	DIPA	DIPB	RAM	RAM	RAM	RAM	DIA	DIPA
0	1	↑	↑	DIA	DIB	DIPA	DIPB	X	DIB	X	DIPB	DIB	DIPB
1	1	↑	↑	DIA	DIB	DIPA	DIPB	X	DIB	X	DIPB	DIA	DIPA

Design Entry Method

This design element can be used in schematics.

Available Attributes

Attribute	Data Type	Allowed Values	Default	Description
INIT_00 to INIT_3F	Binary/ Hexadecimal	Any	All zeros	Specifies the initial contents of the data portion of the RAM array.
INIT_A	Binary/ Hexadecimal	Any	All zeros	Specifies the initial value of the DOA output port after completing configuration. For Type, the bit width is dependent on the width of the A port of the RAM.
INIT_B	Binary/ Hexadecimal	Any	All zeros	Specifies the initial value of the DOB output port after completing configuration. For Type, the bit width is dependent on the width of the B port of the RAM.
INITP_00 to INITP_07	Binary/ Hexadecimal	Any	All zeros	Specifies the initial contents of the parity portion of the RAM array.
SIM_COLLISION_CHECK	String	"ALL", "WARNING_ONLY", "GENERATE_X_ONLY", "NONE"	"ALL"	<p>Allows modification of the simulation behavior if a memory collision occurs. The output is affected as follows:</p> <ul style="list-style-type: none"> "ALL" - Warning produced and affected outputs/memory location go unknown (X). "WARNING_ONLY" - Warning produced and affected outputs/memory retain last value. "GENERATE_X_ONLY" - No warning. However, affected outputs/memory go unknown (X). "NONE" - No warning and affected outputs/memory retain last value. <p>Note Setting this to a value other than "ALL" can allow problems in the design go unnoticed during simulation. Care should be taken when changing the value of this attribute. Please see the <i>Synthesis and Simulation Design Guide</i> for more information.</p>
SRVAL_A	Binary/ Hexadecimal	Any	All zeros	Sets on a per-bit basis whether the DOA output port sets (goes to a one) or resets (goes to a zero) upon the assertion of the RSTA pin. For Type, the bit width is dependent on the width of the A port of the RAM. Default is all bits reset.
SRVAL_B	Binary/ Hexadecimal	Any	All zeros	Sets on a per-bit basis whether the DOB output port sets (goes to a one) or resets (goes to a zero) upon the assertion of the RSTB pin. For Type, the bit width is dependent on the width of the B port of the RAM. Default is all bits reset.

Attribute	Data Type	Allowed Values	Default	Description
WRITE_MODE_A	String	"WRITE_FIRST", "READ_FIRST", "NO_CHANGE"	"WRITE_FIRST"	<p>Specifies the behavior of the DOA port upon a write command to the port.</p> <ul style="list-style-type: none"> "WRITE_FIRST" - the same port that is written to displays the contents of the written data to the outputs upon completion of the operation. "READ_FIRST" - displays the prior contents of the RAM to the output port prior to writing the new data. "NO_CHANGE" - keeps the previous value on the output port and does not update the output port upon a write command. This is the suggested mode if not using the read data from a particular port of the RAM.
WRITE_MODE_B	String	"WRITE_FIRST", "READ_FIRST", "NO_CHANGE"	"WRITE_FIRST"	<p>Specifies the behavior of the DOB port upon a write command to the port.</p> <ul style="list-style-type: none"> "WRITE_FIRST" - the same port that is written to displays the contents of the written data to the outputs upon completion of the operation. "READ_FIRST" - displays the prior contents of the RAM to the output port prior to writing the new data. "NO_CHANGE" - keeps the previous value on the output port and does not update the output port upon a write command. This is the suggested mode if not using the read data from a particular port of the RAM.

For More Information

- See the [Spartan-3 Generation FPGA User Guide \(UG331\)](#).
- See the [Spartan-3E FPGA Family Data Sheet \(DS312\)](#).

RAMB16_S4_S4

Primitive: 16K-bit Data and 2K-bit Parity Dual-Port Synchronous Block RAM with 4-bit Ports

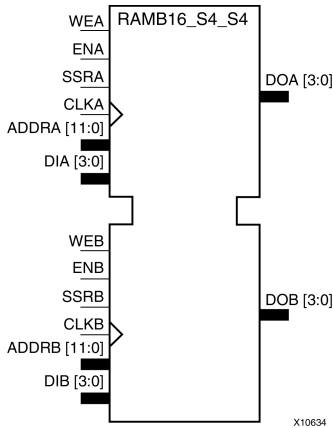

Introduction

This design element is a dual-ported dedicated random access memory block with synchronous write capability. Each block RAM port has 16384 bits of data memory. Ports configured as 9, 18, or 36 bits wide have an additional 2048 bits of parity memory. Each port is independent of the other while accessing the same set of 16384 data memory cells. Each port is independently configured to a specific data width. The possible port and cell configurations for this element are listed in the "Port Descriptions" section.

Logic Table

Truth Table A

Inputs								Outputs			
GSR	ENA	SSRA	WEA	CLKA	ADDR_A	DIA	DIPA	DOA	DOPA	RAM Contents	
										Data RAM	Parity RAM
1	X	X	X	X	X	X	X	INIT_A	INIT_A	No Change	No Change
0	0	X	X	X	X	X	X	No Change	No Change	No Change	No Change
0	1	1	0	↑	X	X	X	SRVAL_A	SRVAL_A	No Change	No Change
0	1	1	1	↑	addr	data	pdata	SRVAL_A	SRVAL_A	RAM(addr) =>data	RAM(addr) =>pdata
0	1	0	0	↑	addr	X	X	RAM(addr)	RAM(addr)	No Change	No Change
0	1	0	1	↑	addr	data	pdata	No Change ¹ , RAM(addr) ² , data ³	No Change ¹ , RAM(addr) ² , pdata ³	RAM(addr) =>data	RAM(addr) =>pdata

GSR=Global Set Reset.

INIT_A=Value specified by the INIT_A attribute for output register. Default is all zeros.

SRVAL_A=register value.

addr=RAM address.

RAM(addr)=RAM contents at address ADDR.

data=RAM input data.

pdata=RAM parity data.

Inputs								Outputs		
GSR	ENA	SSRA	WEA	CLKA	ADDRA	DIA	DIPA	DOA	DOPA	RAM Contents
									Data RAM	Parity RAM
¹ WRITE_MODE_A=NO_CHANGE. ² WRITE_MODE_A=READ_FIRST. ³ WRITE_MODE_A=WRITE_FIRST.										

Truth Table B

Inputs								Outputs			
GSR	ENB	SSRB	WEB	CLKB	ADDRB	DIB	DIPB	DOB	DOPB	RAM Contents	
										Data RAM	Parity RAM
1	X	X	X	X	X	X	X	INIT_B	INIT_B	No Change	No Change
0	0	X	X	X	X	X	X	No Change	No Change	No Change	No Change
0	1	1	0	↑	X	X	X	SRVAL_B	SRVAL_B	No Change	No Change
0	1	1	1	↑	addr	data	pdata	SRVAL_B	SRVAL_B	RAM(addr) =>data	RAM(addr) =>pdata
0	1	0	0	↑	addr	X	X	RAM(addr)	RAM(addr)	No Change	No Change
0	1	0	1	↑	addr	data	pdata	No Change ¹ , RAM(addr) ² , data ³	No Change ¹ , RAM(addr) ² , pdata ³	RAM(addr) =>data	RAM(addr) =>pdata

GSR=Global Set Reset.
 INIT_B=Value specified by the INIT_B attribute for output registers. Default is all zeros.
 SRVAL_B=register value.
 addr=RAM address.
 RAM(addr)=RAM contents at address ADDR.
 data=RAM input data.
 pdata=RAM parity data.
¹WRITE_MODE_B=NO_CHANGE.
²WRITE_MODE_B=READ_FIRST.
³WRITE_MODE_B=WRITE_FIRST.

Port Descriptions

Port A						Port B				
Design Element	Data Cells ¹	Parity Cells ¹	Address Bus	Data Bus	Parity Bus	Data Cells ¹	Parity Cells ¹	Address Bus	Data Bus	Parity Bus
RAMB16_S4_S4	4096 x 4	-	(11:0)	(3:0)	-	4096 x 4	-	(11:0)	(3:0)	-

¹Depth x Width

Each port is fully synchronous with independent clock pins. All Port A input pins have setup time referenced to the CLKA pin and its data output bus DOA has a clock-to-out time referenced to the CLKA. All Port B input pins have setup time referenced to the CLKB pin and its data output bus DOB has a clock-to-out time referenced to the CLKB. The enable ENA pin controls read, write, and reset for Port A. When ENA is Low, no data is written and the outputs (DOA and DOPA) retain the last state. When ENA is High and reset (SSRA) is High, DOA and DOPA are set to SRVAL_A during the Low-to-High clock (CLKA) transition; if write enable (WEA) is High, the memory contents reflect the data at DIA and DIPA. When ENA is High and WEA is Low, the data stored in the RAM address (ADDRA) is read during the Low-to-High clock transition. By default, WRITE_MODE_A=WRITE_FIRST, when ENA and WEA are High, the data on the data inputs (DIA and DIPA) is loaded into the word selected by the write address (ADDRA) during the Low-to-High clock transition and the data outputs (DOA and DOPA) reflect the selected (addressed) word.

The enable ENB pin controls read, write, and reset for Port B. When ENB is Low, no data is written and the outputs (DOB and DOPB) retain the last state. When ENB is High and reset (SSRB) is High, DOB and DOPB are set to SRVAL_B during the Low-to-High clock (CLKB) transition; if write enable (WEB) is High, the memory contents reflect the data at DIB and DIPB. When ENB is High and WEB is Low, the data stored in the RAM address (ADDRB) is read during the Low-to-High clock transition. By default, WRITE_MODE_B=WRITE_FIRST, when ENB and WEB are High, the data on the data inputs (DIB and PB) are loaded into the word selected by the write address (ADDRB) during the Low-to-High clock transition and the data outputs (DOB and DOPB) reflect the selected (addressed) word. The above descriptions assume active High control pins (ENA, WEA, SSRB, CLKA, ENB, WEB, SSRB, and CLKB). However, the active level can be changed by placing an inverter on the port. Any inverter placed on a RAMB16 port is absorbed into the block and does not use a CLB resource.

Address Mapping

Each port accesses the same set of 18432 memory cells using an addressing scheme that is dependent on the width of the port. For all port widths, 16384 memory cells are available for data as shown in the Port Address Mapping for Data table below. For 9-, 18-, and 36-bit wide ports, 2408 parity memory cells are also available as shown in Port Address Mapping for Parity table below. The physical RAM location that is addressed for a particular width is determined from the following formula.

$$\text{Start} = ((\text{ADDR port} + 1) * (\text{Widthport})) - 1$$

$$\text{End} = (\text{ADDRport}) * (\text{Widthport})$$

The following tables shows address mapping for each port width.

Port Address Mapping for Data

Data Width	Port Data Addresses																																	
1	16384	<--	31	30	29	28	27	26	25	24	23	22	21	20	19	18	17	16	15	14	13	12	11	10	9	8	7	6	5	4	3	2	1	0
2	8192	<--	15	14	13	12	11	10	9	8	7	6	5	4	3	2	1	0																
4	4096	<--	7	6	5	4	3	2	1	0																								
8	2048	<--	3	2	1	0																												
16	1024	<--	1	0																														
32	512	<--	0																															

Port Address Mapping for Parity

Parity Width	Port Parity Addresses																	
1	2048	<-----	3	2	1	0												
2	1024	<-----	1	0														
4	512	<-----	0															

Initializing Memory Contents of a Dual-Port RAMB16

You can use the INIT_xx attributes to specify an initialization value for the memory contents of a RAMB16 during device configuration. The initialization of each RAMB16_Sm_Sn is set by 64 initialization attributes (INIT_00 through INIT_3F) of 64 hex values for a total of 16384 bits.

You can use the INITP_xx attributes to specify an initial value for the parity memory during device configuration or assertion. The initialization of the parity memory for ports configured for 9, 18, or 36 bits is set by 8 initialization attributes (INITP_00 through INITP_07) of 64 hex values for a total of 2048 bits.

If any INIT_xx or INITP_xx attribute is not specified, it is configured as zeros. Partial Strings are padded with zeros to the left.

Initializing the Output Register of a Dual-Port RAMB16

In Spartan®-3A and above devices, each bit in an output register can be initialized at power on (when GSR is high) to either a 0 or 1. In addition, the initial state specified for power on can be different than the state that results from assertion of a set/reset. Four properties control initialization of the output register for a dual-port RAMB16: INIT_A, INIT_B, SRVAL_A, and SRVAL_B. The INIT_A attribute specifies the output register value at power on for Port A and the INIT_B attribute specifies the value for Port B. You can use the SRVAL_A attribute to define the state resulting from assertion of the SSR (set/reset) input on Port A. You can use the SRVAL_B attribute to define the state resulting from assertion of the SSR input on Port B.

The INIT_A, INIT_B, SRVAL_A, and SRVAL_B attributes specify the initialization value as a hexadecimal String. The value is dependent upon the port width. For example, for a RAMB16_S1_S4 with Port A width equal to 1 and Port B width equal to 4, the Port A output register contains 1 bit and the Port B output register contains 4 bits. Therefore, the INIT_A or SRVAL_A value can only be specified as a 1 or 0. For Port B, the output register contains 4 bits. In this case, you can use INIT_B or SRVAL_B to specify a hexadecimal value from 0 through F to initialize the 4 bits of the output register.

For those ports that include parity bits, the parity portion of the output register is specified in the high order bit position of the INIT_A, INIT_B, SRVAL_A, or SRVAL_B value.

The INIT and SRVAL attributes default to zero if they are not set by you.

Write Mode Selection

The WRITE_MODE_A attribute controls the memory and output contents of Port A for a dual-port RAMB16. The WRITE_MODE_B attribute does the same for Port B. By default, both WRITE_MODE_A and WRITE_MODE_B are set to WRITE_FIRST. This means that input is read, written to memory, and then passed to output. You can set the write mode for Port A and Port B to READ_FIRST to read the memory contents, pass the memory contents to the outputs, and then write the input to memory. Or, you can set the write mode to NO_CHANGE to have the input written to memory without changing the output. The Port A and Port B Conflict Resolution section describes how read/write conflicts are resolved when both Port A and Port B are attempting to read/write to the same memory cells.

Port A and Port B Conflict Resolution

Spartan-3A block SelectRAM™ is True Dual-Port RAM that allows both ports to simultaneously access the same memory cell. When one port writes to a given memory cell, the other port must not address that memory cell (for a write or a read) within the clock-to-clock setup window.

The following tables summarize the collision detection behavior of the dual-port RAMB16 based on the WRITE_MODE_A and WRITE_MODE_B settings.

WRITE_MODE_A=NO_CHANGE and WRITE_MODE_B=NO_CHANGE

WEA	WEB	CLKA	CLKB	DIA	DIB	DIPA	DIPB	DOA	DOB	DOPA	DOPB	Data RAM	Parity Ram
0	0	↑	↑	DIA	DIB	DIPA	DIPB	RAM	RAM	RAM	RAM	No Change	No Change
1	0	↑	↑	DIA	DIB	DIPA	DIPB	No Change	X	No Change	X	DIA	DIPA
0	1	↑	↑	DIA	DIB	DIPA	DIPB	X	No Change	X	No Change	DIB	DIPB
1	1	↑	↑	DIA	DIB	DIPA	DIPB	No Change	No Change	No Change	No Change	X	X

WRITE_MODE_A=READ_FIRST and WRITE_MODE_B=READ_FIRST

WEA	WEB	CLKA	CLKB	DIA	DIB	DIPA	DIPB	DOA	DOB	DOPA	DOPB	Data RAM	Parity Ram
0	0	↑	↑	DIA	DIB	DIPA	DIPB	RAM	RAM	RAM	RAM	No Change	No Change
1	0	↑	↑	DIA	DIB	DIPA	DIPB	RAM	RAM	RAM	RAM	DIA	DIPA

WEA	WEB	CLKA	CLKB	DIA	DIB	DIPA	DIPB	DOA	DOB	DOPA	DOPB	Data RAM	Parity Ram
0	1	↑	↑	DIA	DIB	DIPA	DIPB	RAM	RAM	RAM	RAM	DIB	DIPB
1	1	↑	↑	DIA	DIB	DIPA	DIPB	RAM	RAM	RAM	RAM	X	X

WRITE_MODE_A= WRITE_FIRST and WRITE_MODE_B=WRITE_FIRST

WEA	WEB	CLKA	CLKB	DIA	DIB	DIPA	DIPB	DOA	DOB	DOPA	DOPB	Data RAM	Parity Ram
0	0	↑	↑	DIA	DIB	DIPA	DIPB	RAM	RAM	RAM	RAM	No Change	No Change
1	0	↑	↑	DIA	DIB	DIPA	DIPB	DIA	X	DIPA	X	DIA	DIPA
0	1	↑	↑	DIA	DIB	DIPA	DIPB	X	DIB	X	DIPB	DIB	DIPB
1	1	↑	↑	DIA	DIB	DIPA	DIPB	X	X	X	X	X	X

WRITE_MODE_A=NO_CHANGE and WRITE_MODE_B=READ_FIRST

WEA	WEB	CLKA	CLKB	DIA	DIB	DIPA	DIPB	DOA	DOB	DOPA	DOPB	Data RAM	Parity Ram
0	0	↑	↑	DIA	DIB	DIPA	DIPB	RAM	RAM	RAM	RAM	No Change	No Change
1	0	↑	↑	DIA	DIB	DIPA	DIPB	No Change	X	No Change	X	DIA	DIPA
0	1	↑	↑	DIA	DIB	DIPA	DIPB	RAM	RAM	RAM	RAM	DIB	DIPB
1	1	↑	↑	DIA	DIB	DIPA	DIPB	No Change	X	No Change	X	DIB	DIPB

WRITE_MODE_A=NO_CHANGE and WRITE_MODE_B=WRITE_FIRST

WEA	WEB	CLKA	CLKB	DIA	DIB	DIPA	DIPB	DOA	DOB	DOPA	DOPB	Data RAM	Parity Ram
0	0	↑	↑	DIA	DIB	DIPA	DIPB	RAM	RAM	RAM	RAM	No Change	No Change
1	0	↑	↑	DIA	DIB	DIPA	DIPB	No Change	X	No Change	X	DIA	DIPA
0	1	↑	↑	DIA	DIB	DIPA	DIPB	X	DIB	X	DIPB	DIB	DIPB
1	1	↑	↑	DIA	DIB	DIPA	DIPB	No Change	X	No Change	X	X	X

WRITE_MODE_A=READ_FIRST and WRITE_MODE_B=WRITE_FIRST

WEA	WEB	CLKA	CLKB	DIA	DIB	DIPA	DIPB	DOA	DOB	DOPA	DOPB	Data RAM	Parity Ram
0	0	↑	↑	DIA	DIB	DIPA	DIPB	RAM	RAM	RAM	RAM	No Change	No Change
1	0	↑	↑	DIA	DIB	DIPA	DIPB	RAM	RAM	RAM	RAM	DIA	DIPA
0	1	↑	↑	DIA	DIB	DIPA	DIPB	X	DIB	X	DIPB	DIB	DIPB
1	1	↑	↑	DIA	DIB	DIPA	DIPB	X	DIB	X	DIPB	DIA	DIPA

Design Entry Method

This design element can be used in schematics.

Available Attributes

Attribute	Data Type	Allowed Values	Default	Description
INIT_00 to INIT_3F	Binary/ Hexadecimal	Any	All zeros	Specifies the initial contents of the data portion of the RAM array.
INIT_A	Binary/ Hexadecimal	Any	All zeros	Specifies the initial value of the DOA output port after completing configuration. For Type, the bit width is dependent on the width of the A port of the RAM.
INIT_B	Binary/ Hexadecimal	Any	All zeros	Specifies the initial value of the DOB output port after completing configuration. For Type, the bit width is dependent on the width of the B port of the RAM.
INITP_00 to INITP_07	Binary/ Hexadecimal	Any	All zeros	Specifies the initial contents of the parity portion of the RAM array.
SIM_COLLISION_CHECK	String	"ALL", "WARNING_ONLY", "GENERATE_X_ONLY", "NONE"	"ALL"	<p>Allows modification of the simulation behavior if a memory collision occurs. The output is affected as follows:</p> <ul style="list-style-type: none"> "ALL" - Warning produced and affected outputs/memory location go unknown (X). "WARNING_ONLY" - Warning produced and affected outputs/memory retain last value. "GENERATE_X_ONLY" - No warning. However, affected outputs/memory go unknown (X). "NONE" - No warning and affected outputs/memory retain last value. <p>Note Setting this to a value other than "ALL" can allow problems in the design go unnoticed during simulation. Care should be taken when changing the value of this attribute. Please see the <i>Synthesis and Simulation Design Guide</i> for more information.</p>
SRVAL_A	Binary/ Hexadecimal	Any	All zeros	Sets on a per-bit basis whether the DOA output port sets (goes to a one) or resets (goes to a zero) upon the assertion of the RSTA pin. For Type, the bit width is dependent on the width of the A port of the RAM. Default is all bits reset.
SRVAL_B	Binary/ Hexadecimal	Any	All zeros	Sets on a per-bit basis whether the DOB output port sets (goes to a one) or resets (goes to a zero) upon the assertion of the RSTB pin. For Type, the bit width is dependent on the width of the B port of the RAM. Default is all bits reset.

Attribute	Data Type	Allowed Values	Default	Description
WRITE_MODE_A	String	"WRITE_FIRST", "READ_FIRST", "NO_CHANGE"	"WRITE_FIRST"	<p>Specifies the behavior of the DOA port upon a write command to the port.</p> <ul style="list-style-type: none"> "WRITE_FIRST" - the same port that is written to displays the contents of the written data to the outputs upon completion of the operation. "READ_FIRST" - displays the prior contents of the RAM to the output port prior to writing the new data. "NO_CHANGE" - keeps the previous value on the output port and does not update the output port upon a write command. This is the suggested mode if not using the read data from a particular port of the RAM.
WRITE_MODE_B	String	"WRITE_FIRST", "READ_FIRST", "NO_CHANGE"	"WRITE_FIRST"	<p>Specifies the behavior of the DOB port upon a write command to the port.</p> <ul style="list-style-type: none"> "WRITE_FIRST" - the same port that is written to displays the contents of the written data to the outputs upon completion of the operation. "READ_FIRST" - displays the prior contents of the RAM to the output port prior to writing the new data. "NO_CHANGE" - keeps the previous value on the output port and does not update the output port upon a write command. This is the suggested mode if not using the read data from a particular port of the RAM.

For More Information

- See the [Spartan-3 Generation FPGA User Guide \(UG331\)](#).
- See the [Spartan-3E FPGA Family Data Sheet \(DS312\)](#).

RAMB16_S4_S9

Primitive: 16K-bit Data and 2K-bit Parity Dual-Port Synchronous Block RAM with 4-bit and 9-bit Ports

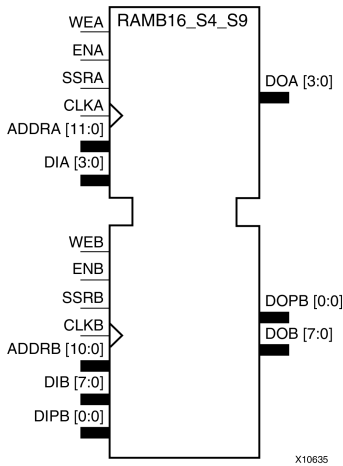

Introduction

This design element is a dual-ported dedicated random access memory block with synchronous write capability. Each block RAM port has 16384 bits of data memory. Ports configured as 9, 18, or 36 bits wide have an additional 2048 bits of parity memory. Each port is independent of the other while accessing the same set of 16384 data memory cells. Each port is independently configured to a specific data width. The possible port and cell configurations for this element are listed in the "Port Descriptions" section.

Logic Table

Truth Table A

Inputs								Outputs			
GSR	ENA	SSRA	WEA	CLKA	ADDR_A	DIA	DIPA	DOA	DOPA	RAM Contents	
										Data RAM	Parity RAM
1	X	X	X	X	X	X	X	INIT_A	INIT_A	No Change	No Change
0	0	X	X	X	X	X	X	No Change	No Change	No Change	No Change
0	1	1	0	↑	X	X	X	SRVAL_A	SRVAL_A	No Change	No Change
0	1	1	1	↑	addr	data	pdata	SRVAL_A	SRVAL_A	RAM(addr) =>data	RAM(addr) =>pdata
0	1	0	0	↑	addr	X	X	RAM(addr)	RAM(addr)	No Change	No Change
0	1	0	1	↑	addr	data	pdata	No Change ¹ , RAM(addr) ² , data ³	No Change ¹ , RAM(addr) ² , pdata ³	RAM(addr) =>data	RAM(addr) =>pdata

GSR=Global Set Reset.

INIT_A=Value specified by the INIT_A attribute for output register. Default is all zeros.

SRVAL_A=register value.

addr=RAM address.

RAM(addr)=RAM contents at address ADDR.

Inputs								Outputs				
GSR	ENA	SSRA	WEA	CLKA	ADDRA	DIA	DIPA	DOA	DOPA	RAM Contents		
											Data RAM	Parity RAM
<p>data=RAM input data.</p> <p>pdata=RAM parity data.</p> <p>¹WRITE_MODE_A=NO_CHANGE.</p> <p>²WRITE_MODE_A=READ_FIRST.</p> <p>³WRITE_MODE_A=WRITE_FIRST.</p>												

Truth Table B

Inputs								Outputs			
GSR	ENB	SSRB	WEB	CLKB	ADDRB	DIB	DIPB	DOB	DOPB	RAM Contents	
										Data RAM	Parity RAM
1	X	X	X	X	X	X	X	INIT_B	INIT_B	No Change	No Change
0	0	X	X	X	X	X	X	No Change	No Change	No Change	No Change
0	1	1	0	↑	X	X	X	SRVAL_B	SRVAL_B	No Change	No Change
0	1	1	1	↑	addr	data	pdata	SRVAL_B	SRVAL_B	RAM(addr) =>data	RAM(addr) =>pdata
0	1	0	0	↑	addr	X	X	RAM(addr)	RAM(addr)	No Change	No Change
0	1	0	1	↑	addr	data	pdata	No Change ¹ , RAM(addr) ² , data ³	No Change ¹ , RAM(addr) ² , pdata ³	RAM(addr) =>data	RAM(addr) =>pdata

GSR=Global Set Reset.
 INIT_B=Value specified by the INIT_B attribute for output registers. Default is all zeros.
 SRVAL_B=register value.
 addr=RAM address.
 RAM(addr)=RAM contents at address ADDR.
 data=RAM input data.
 pdata=RAM parity data.
¹WRITE_MODE_B=NO_CHANGE.
²WRITE_MODE_B=READ_FIRST.
³WRITE_MODE_B=WRITE_FIRST.

Port Descriptions

Port A						Port B				
Design Element	Data Cells ¹	Parity Cells ¹	Address Bus	Data Bus	Parity Bus	Data Cells ¹	Parity Cells ¹	Address Bus	Data Bus	Parity Bus
RAMB16_S4_S9	4096 x 4	-	(11:0)	(3:0)	-	2048 x 8	2048 x 1	(10:0)	(7:0)	(0:0)

¹Depth x Width

Each port is fully synchronous with independent clock pins. All Port A input pins have setup time referenced to the CLKA pin and its data output bus DOA has a clock-to-out time referenced to the CLKA. All Port B input pins have setup time referenced to the CLKB pin and its data output bus DOB has a clock-to-out time referenced to the CLKB. The enable ENA pin controls read, write, and reset for Port A. When ENA is Low, no data is written and the outputs (DOA and DOPA) retain the last state. When ENA is High and reset (SSRA) is High, DOA and DOPA are set to SRVAL_A during the Low-to-High clock (CLKA) transition; if write enable (WEA) is High, the memory contents reflect the data at DIA and DIPA. When ENA is High and WEA is Low, the data stored in the RAM address (ADDRA) is read during the Low-to-High clock transition. By default, WRITE_MODE_A=WRITE_FIRST, when ENA and WEA are High, the data on the data inputs (DIA and DIPA) is loaded into the word selected by the write address (ADDRA) during the Low-to-High clock transition and the data outputs (DOA and DOPA) reflect the selected (addressed) word.

In Spartan®-3A and above devices, each bit in an output register can be initialized at power on (when GSR is high) to either a 0 or 1. In addition, the initial state specified for power on can be different than the state that results from assertion of a set/reset. Four properties control initialization of the output register for a dual-port RAMB16: INIT_A, INIT_B, SRVAL_A, and SRVAL_B. The INIT_A attribute specifies the output register value at power on for Port A and the INIT_B attribute specifies the value for Port B. You can use the SRVAL_A attribute to define the state resulting from assertion of the SSR (set/reset) input on Port A. You can use the SRVAL_B attribute to define the state resulting from assertion of the SSR input on Port B.

The INIT_A, INIT_B, SRVAL_A, and SRVAL_B attributes specify the initialization value as a hexadecimal String. The value is dependent upon the port width. For example, for a RAMB16_S1_S4 with Port A width equal to 1 and Port B width equal to 4, the Port A output register contains 1 bit and the Port B output register contains 4 bits. Therefore, the INIT_A or SRVAL_A value can only be specified as a 1 or 0. For Port B, the output register contains 4 bits. In this case, you can use INIT_B or SRVAL_B to specify a hexadecimal value from 0 through F to initialize the 4 bits of the output register.

For those ports that include parity bits, the parity portion of the output register is specified in the high order bit position of the INIT_A, INIT_B, SRVAL_A, or SRVAL_B value.

The INIT and SRVAL attributes default to zero if they are not set by you.

Write Mode Selection

The WRITE_MODE_A attribute controls the memory and output contents of Port A for a dual-port RAMB16. The WRITE_MODE_B attribute does the same for Port B. By default, both WRITE_MODE_A and WRITE_MODE_B are set to WRITE_FIRST. This means that input is read, written to memory, and then passed to output. You can set the write mode for Port A and Port B to READ_FIRST to read the memory contents, pass the memory contents to the outputs, and then write the input to memory. Or, you can set the write mode to NO_CHANGE to have the input written to memory without changing the output. The Port A and Port B Conflict Resolution section describes how read/write conflicts are resolved when both Port A and Port B are attempting to read/write to the same memory cells.

Port A and Port B Conflict Resolution

Spartan-3A block SelectRAM™ is True Dual-Port RAM that allows both ports to simultaneously access the same memory cell. When one port writes to a given memory cell, the other port must not address that memory cell (for a write or a read) within the clock-to-clock setup window.

The following tables summarize the collision detection behavior of the dual-port RAMB16 based on the WRITE_MODE_A and WRITE_MODE_B settings.

WRITE_MODE_A=NO_CHANGE and WRITE_MODE_B=NO_CHANGE

WEA	WEB	CLKA	CLKB	DIA	DIB	DIPA	DIPB	DOA	DOB	DOPA	DOPB	Data RAM	Parity Ram
0	0	↑	↑	DIA	DIB	DIPA	DIPB	RAM	RAM	RAM	RAM	No Change	No Change
1	0	↑	↑	DIA	DIB	DIPA	DIPB	No Change	X	No Change	X	DIA	DIPA
0	1	↑	↑	DIA	DIB	DIPA	DIPB	X	No Change	X	No Change	DIB	DIPB
1	1	↑	↑	DIA	DIB	DIPA	DIPB	No Change	No Change	No Change	No Change	X	X

WRITE_MODE_A=READ_FIRST and WRITE_MODE_B=READ_FIRST

WEA	WEB	CLKA	CLKB	DIA	DIB	DIPA	DIPB	DOA	DOB	DOPA	DOPB	Data RAM	Parity Ram
0	0	↑	↑	DIA	DIB	DIPA	DIPB	RAM	RAM	RAM	RAM	No Change	No Change
1	0	↑	↑	DIA	DIB	DIPA	DIPB	RAM	RAM	RAM	RAM	DIA	DIPA

WEA	WEB	CLKA	CLKB	DIA	DIB	DIPA	DIPB	DOA	DOB	DOPA	DOPB	Data RAM	Parity Ram
0	1	↑	↑	DIA	DIB	DIPA	DIPB	RAM	RAM	RAM	RAM	DIB	DIPB
1	1	↑	↑	DIA	DIB	DIPA	DIPB	RAM	RAM	RAM	RAM	X	X

WRITE_MODE_A= WRITE_FIRST and WRITE_MODE_B=WRITE_FIRST

WEA	WEB	CLKA	CLKB	DIA	DIB	DIPA	DIPB	DOA	DOB	DOPA	DOPB	Data RAM	Parity Ram
0	0	↑	↑	DIA	DIB	DIPA	DIPB	RAM	RAM	RAM	RAM	No Change	No Change
1	0	↑	↑	DIA	DIB	DIPA	DIPB	DIA	X	DIPA	X	DIA	DIPA
0	1	↑	↑	DIA	DIB	DIPA	DIPB	X	DIB	X	DIPB	DIB	DIPB
1	1	↑	↑	DIA	DIB	DIPA	DIPB	X	X	X	X	X	X

WRITE_MODE_A=NO_CHANGE and WRITE_MODE_B=READ_FIRST

WEA	WEB	CLKA	CLKB	DIA	DIB	DIPA	DIPB	DOA	DOB	DOPA	DOPB	Data RAM	Parity Ram
0	0	↑	↑	DIA	DIB	DIPA	DIPB	RAM	RAM	RAM	RAM	No Change	No Change
1	0	↑	↑	DIA	DIB	DIPA	DIPB	No Change	X	No Change	X	DIA	DIPA
0	1	↑	↑	DIA	DIB	DIPA	DIPB	RAM	RAM	RAM	RAM	DIB	DIPB
1	1	↑	↑	DIA	DIB	DIPA	DIPB	No Change	X	No Change	X	DIB	DIPB

WRITE_MODE_A=NO_CHANGE and WRITE_MODE_B=WRITE_FIRST

WEA	WEB	CLKA	CLKB	DIA	DIB	DIPA	DIPB	DOA	DOB	DOPA	DOPB	Data RAM	Parity Ram
0	0	↑	↑	DIA	DIB	DIPA	DIPB	RAM	RAM	RAM	RAM	No Change	No Change
1	0	↑	↑	DIA	DIB	DIPA	DIPB	No Change	X	No Change	X	DIA	DIPA
0	1	↑	↑	DIA	DIB	DIPA	DIPB	X	DIB	X	DIPB	DIB	DIPB
1	1	↑	↑	DIA	DIB	DIPA	DIPB	No Change	X	No Change	X	X	X

WRITE_MODE_A=READ_FIRST and WRITE_MODE_B=WRITE_FIRST

WEA	WEB	CLKA	CLKB	DIA	DIB	DIPA	DIPB	DOA	DOB	DOPA	DOPB	Data RAM	Parity Ram
0	0	↑	↑	DIA	DIB	DIPA	DIPB	RAM	RAM	RAM	RAM	No Change	No Change
1	0	↑	↑	DIA	DIB	DIPA	DIPB	RAM	RAM	RAM	RAM	DIA	DIPA
0	1	↑	↑	DIA	DIB	DIPA	DIPB	X	DIB	X	DIPB	DIB	DIPB
1	1	↑	↑	DIA	DIB	DIPA	DIPB	X	DIB	X	DIPB	DIA	DIPA

Design Entry Method

This design element can be used in schematics.

Available Attributes

Attribute	Data Type	Allowed Values	Default	Description
INIT_00 to INIT_3F	Binary/ Hexadecimal	Any	All zeros	Specifies the initial contents of the data portion of the RAM array.
INIT_A	Binary/ Hexadecimal	Any	All zeros	Specifies the initial value of the DOA output port after completing configuration. For Type, the bit width is dependent on the width of the A port of the RAM.
INIT_B	Binary/ Hexadecimal	Any	All zeros	Specifies the initial value of the DOB output port after completing configuration. For Type, the bit width is dependent on the width of the B port of the RAM.
INITP_00 to INITP_07	Binary/ Hexadecimal	Any	All zeros	Specifies the initial contents of the parity portion of the RAM array.
SIM_COLLISION_CHECK	String	"ALL", "WARNING_ONLY", "GENERATE_X_ONLY", "NONE"	"ALL"	<p>Allows modification of the simulation behavior if a memory collision occurs. The output is affected as follows:</p> <ul style="list-style-type: none"> "ALL" - Warning produced and affected outputs/memory location go unknown (X). "WARNING_ONLY" - Warning produced and affected outputs/memory retain last value. "GENERATE_X_ONLY" - No warning. However, affected outputs/memory go unknown (X). "NONE" - No warning and affected outputs/memory retain last value. <p>Note Setting this to a value other than "ALL" can allow problems in the design go unnoticed during simulation. Care should be taken when changing the value of this attribute. Please see the <i>Synthesis and Simulation Design Guide</i> for more information.</p>
SRVAL_A	Binary/ Hexadecimal	Any	All zeros	Sets on a per-bit basis whether the DOA output port sets (goes to a one) or resets (goes to a zero) upon the assertion of the RSTA pin. For Type, the bit width is dependent on the width of the A port of the RAM. Default is all bits reset.
SRVAL_B	Binary/ Hexadecimal	Any	All zeros	Sets on a per-bit basis whether the DOB output port sets (goes to a one) or resets (goes to a zero) upon the assertion of the RSTB pin. For Type, the bit width is dependent on the width of the B port of the RAM. Default is all bits reset.

Attribute	Data Type	Allowed Values	Default	Description
WRITE_MODE_A	String	"WRITE_FIRST", "READ_FIRST", "NO_CHANGE"	"WRITE_FIRST"	<p>Specifies the behavior of the DOA port upon a write command to the port.</p> <ul style="list-style-type: none"> "WRITE_FIRST" - the same port that is written to displays the contents of the written data to the outputs upon completion of the operation. "READ_FIRST" - displays the prior contents of the RAM to the output port prior to writing the new data. "NO_CHANGE" - keeps the previous value on the output port and does not update the output port upon a write command. This is the suggested mode if not using the read data from a particular port of the RAM.
WRITE_MODE_B	String	"WRITE_FIRST", "READ_FIRST", "NO_CHANGE"	"WRITE_FIRST"	<p>Specifies the behavior of the DOB port upon a write command to the port.</p> <ul style="list-style-type: none"> "WRITE_FIRST" - the same port that is written to displays the contents of the written data to the outputs upon completion of the operation. "READ_FIRST" - displays the prior contents of the RAM to the output port prior to writing the new data. "NO_CHANGE" - keeps the previous value on the output port and does not update the output port upon a write command. This is the suggested mode if not using the read data from a particular port of the RAM.

For More Information

- See the [Spartan-3 Generation FPGA User Guide \(UG331\)](#).
- See the [Spartan-3E FPGA Family Data Sheet \(DS312\)](#).

RAMB16_S9

Primitive: 16K-bit Data and 2K-bit Parity Single-Port Synchronous Block RAM with 9-bit Port

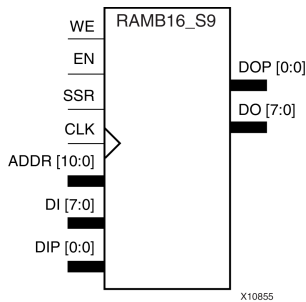

Introduction

This design element is a dedicated random access memory block with synchronous write capability. The block RAM port has 16384 bits of data memory. The cell configuration for this element is listed in the following table.

Data Cells		Parity Cells				
Depth	Width	Depth	Width	Address Bus	Data Bus	Parity Bus
2048	8	2048	1	(10:0)	(7:0)	(0:0)

The enable EN pin controls read, write, and reset. When EN is Low, no data is written and the outputs (DO and DOP) retain the last state. When EN is High and reset (SSR) is High, DO and DOP are set to SRVAL during the Low-to-High clock (CLK) transition; if write enable (WE) is High, the memory contents reflect the data at DI and DIP. When EN is High and WE is Low, the data stored in the RAM address (ADDR) is read during the Low-to-High clock transition. By default, WRITE_MODE=WRITE_FIRST, when EN and WE are High, the data on the data inputs (DI and DIP) is loaded into the word selected by the write address (ADDR) during the Low-to-High clock transition and the data outputs (DO and DOP) reflect the selected (addressed) word.

The above description assumes an active High EN, WE, SSR, and CLK. However, the active level can be changed by placing an inverter on the port. Any inverter placed on a RAMB16 port is absorbed into the block and does not use a CLB resource.

Logic Table

Inputs								Outputs			
GSR	EN	SSR	WE	CLK	ADDR	DI	DIP	DO	DOP	RAM Contents	
										Data RAM	Parity RAM
1	X	X	X	X	X	X	X	INIT	INIT	No Change	No Change
0	0	X	X	X	X	X	X	No Change	No Change	No Change	No Change
0	1	1	0	↑	X	X	X	SRVAL	SRVAL	No Change	No Change
0	1	1	1	↑	addr	data	pdata	SRVAL	SRVAL	RAM(addr) =>data	RAM(addr) =>pdata
0	1	0	0	↑	addr	X	X	RAM (addr)	RAM (addr)	No Change	No Change
0	1	0	1	↑	addr	data	pdata	No Change ¹ RAM	No Change ¹ RAM	RAM (addr)=>data	RAM (addr)=>pdata

Inputs								Outputs			
GSR	EN	SSR	WE	CLK	ADDR	DI	DIP	DO	DOP	RAM Contents	
										Data RAM	Parity RAM
								(addr) ² data ³	(addr) ² pdata ³		
<p>GSR=Global Set Reset signal</p> <p>INIT=Value specified by the INIT attribute for data memory. Default is all zeros.</p> <p>SRVAL=Value after assertion of SSR as specified by the SRVAL attribute.</p> <p>addr=RAM address.</p> <p>RAM(addr)=RAM contents at address ADDR.</p> <p>data=RAM input data.</p> <p>pdata=RAM parity data.</p> <p>¹WRITE_MODE=NO_CHANGE</p> <p>²WRITE_MODE=READ_FIRST</p> <p>³WRITE_MODE=WRITE_FIRST</p>											

Initialization

Initializing Memory Contents

You can use the INIT_xx attributes to specify an initialization value for the memory contents of a RAMB16 during device configuration. The initialization of each RAMB16 is set by 64 initialization attributes (INIT_00 through INIT_3F) of 64 hex values for a total of 16384 bits.

You can use the INITP_xx attributes to specify an initial value for the parity memory during device configuration or assertion. The initialization of the parity memory for ports configured for 9, 18, or 36 bits is set by 8 initialization attributes (INITP_00 through INITP_07) of 64 hex values for a total of 2048 bits.

Any INIT_xx or INITP_xx attribute that is not specified is configured as zeros. Partial Strings are padded with zeros to the left.

Initializing the Output Register

In Spartan®-3A and above devices, each bit in the output register can be initialized at power on to either a 0 or 1. In addition, the initial state specified for power on can be different than the state that results from assertion of a set/reset. Two types of properties control initialization of the output register for a single-port RAMB16: INIT and SRVAL. The INIT attribute specifies the output register value at power on. You can use the SRVAL attribute to define the state resulting from assertion of the SSR (set/reset) input.

The INIT and SRVAL attributes specify the initialization value as a hexadecimal String containing one bit for each bit in the output port. For example, for a RAMB16_S1 with port width equal to 1, the output register contains 1 bit. Therefore, the INIT or SRVAL value can only be specified as a 1 or 0. For RAMB16_S4 with port width equal to 4, the output register contains 4 bits. In this case, you can specify a hexadecimal value from 0 through F to initialize the 4 bits of the output register.

For those ports that include parity bits, the parity portion of the output register is specified in the high order bit position of the INIT or SRVAL value.

Selecting Write Mode

The WRITE_MODE attribute controls RAMB16 memory and output contents. By default, the WRITE_MODE is set to WRITE_FIRST. This means that input is read, written to memory, and then passed to output. You can set the WRITE_MODE to READ_FIRST to read the memory contents, pass the memory contents to the outputs, and then write the input to memory. Or, you can set the WRITE_MODE to NO_CHANGE to have the input written to memory without changing the output.

Design Entry Method

This design element can be used in schematics.

Available Attributes

Attribute	Data Type	Allowed Values	Default	Description
INIT	Binary/ Hexadecimal	Any Hex Value	All zeros	Identifies the initial value of the DO output port after completing configuration. The bit width is dependent on the width of the A or B port of the RAM.
INIT_00 to INIT_3F	Binary/ Hexadecimal	Any Hex Value	All zeros	Specifies the initial contents of the data portion of the RAM array.
INITP_00 to INITP_07	Binary/ Hexadecimal	Any Hex Value	All zeros	Specifies the initial contents of the parity portion of the RAM array.
SRVAL	Binary/ Hexadecimal	Any Hex Value	All zeros	Allows the individual selection of whether the DO output port sets (go to a one) or reset (go to a zero) upon the assertion of the SSR pin. The bit width is dependent on the width of the A or B port of the RAM.
WRITE_MODE	String	"WRITE_FIRST", "READ_FIRST" or "NO_CHANGE"	"WRITE_FIRST"	Specifies the behavior of the DO port upon a write command to the respected port. If set to "WRITE_FIRST", the same port that is written to displays the contents of the written data to the outputs upon completion of the operation. "READ_FIRST" displays the prior contents of the RAM to the output port prior to writing the new data. "NO_CHANGE" keeps the previous value on the output port and wont update the output port upon a write command. This is the suggested mode if not using the read data from a particular port of the RAM.

For More Information

- See the [Spartan-3 Generation FPGA User Guide \(UG331\)](#).
- See the [Spartan-3E FPGA Family Data Sheet \(DS312\)](#).

RAMB16_S9_S18

Primitive: 16K-bit Data and 2K-bit Parity Dual-Port Synchronous Block RAM with 9-bit and 18-bit Ports

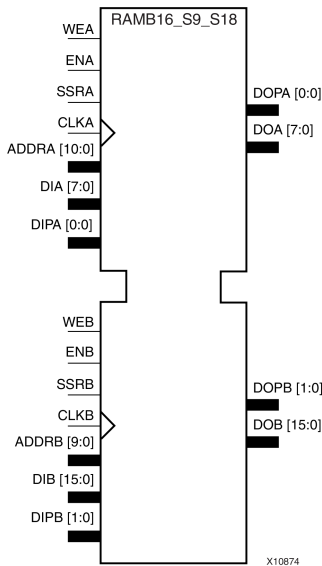

Introduction

This design element is a dual-ported dedicated random access memory block with synchronous write capability. Each block RAM port has 16384 bits of data memory. Ports configured as 9, 18, or 36 bits wide have an additional 2048 bits of parity memory. Each port is independent of the other while accessing the same set of 16384 data memory cells. Each port is independently configured to a specific data width. The possible port and cell configurations for this element are listed in the "Port Descriptions" section.

Logic Table

Truth Table A

Inputs								Outputs			
GSR	ENA	SSRA	WEA	CLKA	ADDR_A	DIA	DIPA	DOA	DOPA	RAM Contents	
										Data RAM	Parity RAM
1	X	X	X	X	X	X	X	INIT_A	INIT_A	No Change	No Change
0	0	X	X	X	X	X	X	No Change	No Change	No Change	No Change
0	1	1	0	↑	X	X	X	SRVAL_A	SRVAL_A	No Change	No Change
0	1	1	1	↑	addr	data	pdata	SRVAL_A	SRVAL_A	RAM(addr) =>data	RAM(addr) =>pdata
0	1	0	0	↑	addr	X	X	RAM(addr)	RAM(addr)	No Change	No Change
0	1	0	1	↑	addr	data	pdata	No Change ¹ , RAM(addr) ² , data ³	No Change ¹ , RAM(addr) ² , pdata ³	RAM(addr) =>data	RAM(addr) =>pdata

GSR=Global Set Reset.

INIT_A=Value specified by the INIT_A attribute for output register. Default is all zeros.

Inputs								Outputs			
GSR	ENA	SSRA	WEA	CLKA	ADDRA	DIA	DIPA	DOA	DOPA	RAM Contents	
									Data RAM	Parity RAM	
<p>SRVAL_A=register value. addr=RAM address. RAM(addr)=RAM contents at address ADDR. data=RAM input data. pdata=RAM parity data. ¹WRITE_MODE_A=NO_CHANGE. ²WRITE_MODE_A=READ_FIRST. ³WRITE_MODE_A=WRITE_FIRST.</p>											

Truth Table B

Inputs								Outputs			
GSR	ENB	SSRB	WEB	CLKB	ADDRB	DIB	DIPB	DOB	DOPB	RAM Contents	
										Data RAM	Parity RAM
1	X	X	X	X	X	X	X	INIT_B	INIT_B	No Change	No Change
0	0	X	X	X	X	X	X	No Change	No Change	No Change	No Change
0	1	1	0	↑	X	X	X	SRVAL_B	SRVAL_B	No Change	No Change
0	1	1	1	↑	addr	data	pdata	SRVAL_B	SRVAL_B	RAM(addr) =>data	RAM(addr) =>pdata
0	1	0	0	↑	addr	X	X	RAM(addr)	RAM(addr)	No Change	No Change
0	1	0	1	↑	addr	data	pdata	No Change ¹ , RAM(addr) ² , data ³	No Change ¹ , RAM(addr) ² , pdata ³	RAM(addr) =>data	RAM(addr) =>pdata

GSR=Global Set Reset.

INIT_B=Value specified by the INIT_B attribute for output registers. Default is all zeros.

SRVAL_B=register value.

addr=RAM address.

RAM(addr)=RAM contents at address ADDR.

data=RAM input data.

pdata=RAM parity data.

¹WRITE_MODE_B=NO_CHANGE.

²WRITE_MODE_B=READ_FIRST.

³WRITE_MODE_B=WRITE_FIRST.

Port Descriptions

Port A						Port B				
Component	Data Cells ¹	Parity Cells ¹	Address Bus	Data Bus	Parity Bus	Data Cells ¹	Parity Cells ¹	Address Bus	Data Bus	Parity Bus
RAMB16_S9_S18	2048 x 8	2048 x 1	(10:0)	(7:0)	(0:0)	1024 x 16	1024 x 2	(9:0)	(15:0)	(1:0)

¹Depth x Width

Each port is fully synchronous with independent clock pins. All Port A input pins have setup time referenced to the CLKA pin and its data output bus DOA has a clock-to-out time referenced to the CLKA. All Port B input pins have setup time referenced to the CLKB pin and its data output bus DOB has a clock-to-out time referenced to the CLKB. The enable ENA pin controls read, write, and reset for Port A. When ENA is Low, no data is written and the outputs (DOA and DOPA) retain the last state. When ENA is High and reset (SSRA) is High, DOA and DOPA are set to SRVAL_A during the Low-to-High clock (CLKA) transition; if write enable (WEA) is High, the memory contents reflect the data at DIA and DIPB. When ENA is High and WEA is Low, the data stored in the RAM address (ADDRB) is read during the Low-to-High clock transition. By default, WRITE_MODE_A=WRITE_FIRST, when ENA and WEA are High, the data on the data inputs (DIA and DIPB) is loaded into the word selected by the write address (ADDRB) during the Low-to-High clock transition and the data outputs (DOA and DOPA) reflect the selected (addressed) word.

The enable ENB pin controls read, write, and reset for Port B. When ENB is Low, no data is written and the outputs (DOB and DOPB) retain the last state. When ENB is High and reset (SSRB) is High, DOB and DOPB are set to SRVAL_B during the Low-to-High clock (CLKB) transition; if write enable (WEB) is High, the memory contents reflect the data at DIB and DIPB. When ENB is High and WEB is Low, the data stored in the RAM address (ADDRB) is read during the Low-to-High clock transition. By default, WRITE_MODE_B=WRITE_FIRST, when ENB and WEB are High, the data on the data inputs (DIB and PB) are loaded into the word selected by the write address (ADDRB) during the Low-to-High clock transition and the data outputs (DOB and DOPB) reflect the selected (addressed) word. The above descriptions assume active High control pins (ENA, WEA, SSRA, CLKA, ENB, WEB, SSRB, and CLKB). However, the active level can be changed by placing an inverter on the port. Any inverter placed on a RAMB16 port is absorbed into the block and does not use a CLB resource.

Address Mapping

Each port accesses the same set of 18432 memory cells using an addressing scheme that is dependent on the width of the port. For all port widths, 16384 memory cells are available for data as shown in the Port Address Mapping for Data table below. For 9-, 18-, and 36-bit wide ports, 2408 parity memory cells are also available as shown in Port Address Mapping for Parity table below. The physical RAM location that is addressed for a particular width is determined from the following formula.

$$\text{Start} = ((\text{ADDR port} + 1) * (\text{Widthport})) - 1$$

$$\text{End} = (\text{ADDRport}) * (\text{Widthport})$$

The following tables show address mapping for each port width.

Port Address Mapping for Data

Data Width	Port Data Addresses																																					
1	16384	<--	31	30	29	28	27	26	25	24	23	22	21	20	19	18	17	16	15	14	13	12	11	10	9	8	7	6	5	4	3	2	1	0				
2	8192	<--	15	14	13	12	11	10	9	8	7	6	5	4	3	2	1	0																				
4	4096	<--	7	6	5	4	3	2	1	0																												
8	2048	<--	3	2	1	0																																
16	1024	<--	1	0																																		
32	512	<--	0																																			

Port Address Mapping for Parity

Parity Width	Port Parity Addresses																																					
1	2048	<-----	3					2					1																								0	
2	1024	<-----	1											0																								
4	512	<-----	0																																			

Initializing Memory Contents of a Dual-Port RAMB16

You can use the INIT_xx attributes to specify an initialization value for the memory contents of a RAMB16 during device configuration. The initialization of each RAMB16_Sm_Sn is set by 64 initialization attributes (INIT_00 through INIT_3F) of 64 hex values for a total of 16384 bits.

You can use the INITP_xx attributes to specify an initial value for the parity memory during device configuration or assertion. The initialization of the parity memory for ports configured for 9, 18, or 36 bits is set by 8 initialization attributes (INITP_00 through INITP_07) of 64 hex values for a total of 2048 bits.

If any INIT_xx or INITP_xx attribute is not specified, it is configured as zeros. Partial Strings are padded with zeros to the left.

Initializing the Output Register of a Dual-Port RAMB16

In Spartan®-3A and above devices, each bit in an output register can be initialized at power on (when GSR is high) to either a 0 or 1. In addition, the initial state specified for power on can be different than the state that results from assertion of a set/reset. Four properties control initialization of the output register for a dual-port RAMB16: INIT_A, INIT_B, SRVAL_A, and SRVAL_B. The INIT_A attribute specifies the output register value at power on for Port A and the INIT_B attribute specifies the value for Port B. You can use the SRVAL_A attribute to define the state resulting from assertion of the SSR (set/reset) input on Port A. You can use the SRVAL_B attribute to define the state resulting from assertion of the SSR input on Port B.

The INIT_A, INIT_B, SRVAL_A, and SRVAL_B attributes specify the initialization value as a hexadecimal String. The value is dependent upon the port width. For example, for a RAMB16_S1_S4 with Port A width equal to 1 and Port B width equal to 4, the Port A output register contains 1 bit and the Port B output register contains 4 bits. Therefore, the INIT_A or SRVAL_A value can only be specified as a 1 or 0. For Port B, the output register contains 4 bits. In this case, you can use INIT_B or SRVAL_B to specify a hexadecimal value from 0 through F to initialize the 4 bits of the output register.

For those ports that include parity bits, the parity portion of the output register is specified in the high order bit position of the INIT_A, INIT_B, SRVAL_A, or SRVAL_B value.

The INIT and SRVAL attributes default to zero if they are not set by you.

Write Mode Selection

The WRITE_MODE_A attribute controls the memory and output contents of Port A for a dual-port RAMB16. The WRITE_MODE_B attribute does the same for Port B. By default, both WRITE_MODE_A and WRITE_MODE_B are set to WRITE_FIRST. This means that input is read, written to memory, and then passed to output. You can set the write mode for Port A and Port B to READ_FIRST to read the memory contents, pass the memory contents to the outputs, and then write the input to memory. Or, you can set the write mode to NO_CHANGE to have the input written to memory without changing the output. The Port A and Port B Conflict Resolution section describes how read/write conflicts are resolved when both Port A and Port B are attempting to read/write to the same memory cells.

Port A and Port B Conflict Resolution

Spartan-3A block SelectRAM™ is True Dual-Port RAM that allows both ports to simultaneously access the same memory cell. When one port writes to a given memory cell, the other port must not address that memory cell (for a write or a read) within the clock-to-clock setup window.

The following tables summarize the collision detection behavior of the dual-port RAMB16 based on the WRITE_MODE_A and WRITE_MODE_B settings.

WRITE_MODE_A=NO_CHANGE and WRITE_MODE_B=NO_CHANGE

WEA	WEB	CLKA	CLKB	DIA	DIB	DIPA	DIPB	DOA	DOB	DOPA	DOPB	Data RAM	Parity Ram
0	0	↑	↑	DIA	DIB	DIPA	DIPB	RAM	RAM	RAM	RAM	No Change	No Change
1	0	↑	↑	DIA	DIB	DIPA	DIPB	No Change	X	No Change	X	DIA	DIPA
0	1	↑	↑	DIA	DIB	DIPA	DIPB	X	No Change	X	No Change	DIB	DIPB
1	1	↑	↑	DIA	DIB	DIPA	DIPB	No Change	No Change	No Change	No Change	X	X

WRITE_MODE_A=READ_FIRST and WRITE_MODE_B=READ_FIRST

WEA	WEB	CLKA	CLKB	DIA	DIB	DIPA	DIPB	DOA	DOB	DOPA	DOPB	Data RAM	Parity Ram
0	0	↑	↑	DIA	DIB	DIPA	DIPB	RAM	RAM	RAM	RAM	No Change	No Change
1	0	↑	↑	DIA	DIB	DIPA	DIPB	RAM	RAM	RAM	RAM	DIA	DIPA
0	1	↑	↑	DIA	DIB	DIPA	DIPB	RAM	RAM	RAM	RAM	DIB	DIPB
1	1	↑	↑	DIA	DIB	DIPA	DIPB	RAM	RAM	RAM	RAM	X	X

WRITE_MODE_A= WRITE_FIRST and WRITE_MODE_B=WRITE_FIRST

WEA	WEB	CLKA	CLKB	DIA	DIB	DIPA	DIPB	DOA	DOB	DOPA	DOPB	Data RAM	Parity Ram
0	0	↑	↑	DIA	DIB	DIPA	DIPB	RAM	RAM	RAM	RAM	No Change	No Change
1	0	↑	↑	DIA	DIB	DIPA	DIPB	DIA	X	DIPA	X	DIA	DIPA
0	1	↑	↑	DIA	DIB	DIPA	DIPB	X	DIB	X	DIPB	DIB	DIPB
1	1	↑	↑	DIA	DIB	DIPA	DIPB	X	X	X	X	X	X

WRITE_MODE_A=NO_CHANGE and WRITE_MODE_B=READ_FIRST

WEA	WEB	CLKA	CLKB	DIA	DIB	DIPA	DIPB	DOA	DOB	DOPA	DOPB	Data RAM	Parity Ram
0	0	↑	↑	DIA	DIB	DIPA	DIPB	RAM	RAM	RAM	RAM	No Change	No Change
1	0	↑	↑	DIA	DIB	DIPA	DIPB	No Change	X	No Change	X	DIA	DIPA
0	1	↑	↑	DIA	DIB	DIPA	DIPB	RAM	RAM	RAM	RAM	DIB	DIPB
1	1	↑	↑	DIA	DIB	DIPA	DIPB	No Change	X	No Change	X	DIB	DIPB

WRITE_MODE_A=NO_CHANGE and WRITE_MODE_B=WRITE_FIRST

WEA	WEB	CLKA	CLKB	DIA	DIB	DIPA	DIPB	DOA	DOB	DOPA	DOPB	Data RAM	Parity Ram
0	0	↑	↑	DIA	DIB	DIPA	DIPB	RAM	RAM	RAM	RAM	No Change	No Change
1	0	↑	↑	DIA	DIB	DIPA	DIPB	No Change	X	No Change	X	DIA	DIPA
0	1	↑	↑	DIA	DIB	DIPA	DIPB	X	DIB	X	DIPB	DIB	DIPB
1	1	↑	↑	DIA	DIB	DIPA	DIPB	No Change	X	No Change	X	X	X

WRITE_MODE_A=READ_FIRST and WRITE_MODE_B=WRITE_FIRST

WEA	WEB	CLKA	CLKB	DIA	DIB	DIPA	DIPB	DOA	DOB	DOPA	DOPB	Data RAM	Parity Ram
0	0	↑	↑	DIA	DIB	DIPA	DIPB	RAM	RAM	RAM	RAM	No Change	No Change
1	0	↑	↑	DIA	DIB	DIPA	DIPB	RAM	RAM	RAM	RAM	DIA	DIPA

WEA	WEB	CLKA	CLKB	DIA	DIB	DIPA	DIPB	DOA	DOB	DOPA	DOPB	Data RAM	Parity Ram
0	1	↑	↑	DIA	DIB	DIPA	DIPB	X	DIB	X	DIPB	DIB	DIPB
1	1	↑	↑	DIA	DIB	DIPA	DIPB	X	DIB	X	DIPB	DIA	DIPA

Design Entry Method

This design element can be used in schematics.

Available Attributes

Attribute	Data Type	Allowed Values	Default	Description
INIT_00 to INIT_3F	Binary/ Hexadecimal	Any	All zeros	Specifies the initial contents of the data portion of the RAM array.
INIT_A	Binary/ Hexadecimal	Any	All zeros	Specifies the initial value of the DOA output port after completing configuration. For Type, the bit width is dependent on the width of the A port of the RAM.
INIT_B	Binary/ Hexadecimal	Any	All zeros	Specifies the initial value of the DOB output port after completing configuration. For Type, the bit width is dependent on the width of the B port of the RAM.
INITP_00 to INITP_07	Binary/ Hexadecimal	Any	All zeros	Specifies the initial contents of the parity portion of the RAM array.
SIM_COLLISION_CHECK	String	"ALL", "WARNING_ONLY", "GENERATE_X_ONLY", "NONE"	"ALL"	<p>Allows modification of the simulation behavior if a memory collision occurs. The output is affected as follows:</p> <ul style="list-style-type: none"> "ALL" - Warning produced and affected outputs/memory location go unknown (X). "WARNING_ONLY" - Warning produced and affected outputs/memory retain last value. "GENERATE_X_ONLY" - No warning. However, affected outputs/memory go unknown (X). "NONE" - No warning and affected outputs/memory retain last value. <p>Note Setting this to a value other than "ALL" can allow problems in the design go unnoticed during simulation. Care should be taken when changing the value of this attribute. Please see the <i>Synthesis and Simulation Design Guide</i> for more information.</p>
SRVAL_A	Binary/ Hexadecimal	Any	All zeros	Sets on a per-bit basis whether the DOA output port sets (goes to a one) or resets (goes to a zero) upon the assertion of the RSTA pin. For Type, the bit width is dependent on the width of the A port of the RAM. Default is all bits reset.
SRVAL_B	Binary/ Hexadecimal	Any	All zeros	Sets on a per-bit basis whether the DOB output port sets (goes to a one) or resets (goes to a zero) upon the assertion of the RSTB pin. For Type, the bit width is dependent on the width of the B port of the RAM. Default is all bits reset.

Attribute	Data Type	Allowed Values	Default	Description
WRITE_MODE_A	String	"WRITE_FIRST", "READ_FIRST", "NO_CHANGE"	"WRITE_FIRST"	<p>Specifies the behavior of the DOA port upon a write command to the port.</p> <ul style="list-style-type: none"> "WRITE_FIRST" - the same port that is written to displays the contents of the written data to the outputs upon completion of the operation. "READ_FIRST" - displays the prior contents of the RAM to the output port prior to writing the new data. "NO_CHANGE" - keeps the previous value on the output port and does not update the output port upon a write command. This is the suggested mode if not using the read data from a particular port of the RAM.
WRITE_MODE_B	String	"WRITE_FIRST", "READ_FIRST", "NO_CHANGE"	"WRITE_FIRST"	<p>Specifies the behavior of the DOB port upon a write command to the port.</p> <ul style="list-style-type: none"> "WRITE_FIRST" - the same port that is written to displays the contents of the written data to the outputs upon completion of the operation. "READ_FIRST" - displays the prior contents of the RAM to the output port prior to writing the new data. "NO_CHANGE" - keeps the previous value on the output port and does not update the output port upon a write command. This is the suggested mode if not using the read data from a particular port of the RAM.

For More Information

- See the [Spartan-3 Generation FPGA User Guide \(UG331\)](#).
- See the [Spartan-3E FPGA Family Data Sheet \(DS312\)](#).

RAMB16_S9_S36

Primitive: 16K-bit Data and 2K-bit Parity Dual-Port Synchronous Block RAM with 9-bit and 36-bit Ports

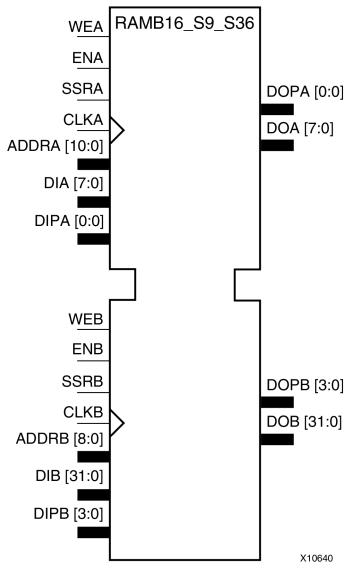

Introduction

This design element is a dual-ported dedicated random access memory block with synchronous write capability. Each block RAM port has 16384 bits of data memory. Ports configured as 9, 18, or 36 bits wide have an additional 2048 bits of parity memory. Each port is independent of the other while accessing the same set of 16384 data memory cells. Each port is independently configured to a specific data width. The possible port and cell configurations for this element are listed in the "Port Descriptions" section.

Logic Table

Truth Table A

Inputs								Outputs			
GSR	ENA	SSRA	WEA	CLKA	ADDR8	DIA	DIPA	DOA	DOPA	RAM Contents	
										Data RAM	Parity RAM
1	X	X	X	X	X	X	X	INIT_A	INIT_A	No Change	No Change
0	0	X	X	X	X	X	X	No Change	No Change	No Change	No Change
0	1	1	0	↑	X	X	X	SRVAL_A	SRVAL_A	No Change	No Change
0	1	1	1	↑	addr	data	pdata	SRVAL_A	SRVAL_A	RAM(addr) =>data	RAM(addr) =>pdata
0	1	0	0	↑	addr	X	X	RAM(addr)	RAM(addr)	No Change	No Change
0	1	0	1	↑	addr	data	pdata	No Change ¹ , RAM(addr) ² , data ³	No Change ¹ , RAM(addr) ² , pdata ³	RAM(addr) =>data	RAM(addr) =>pdata

GSR=Global Set Reset.

INIT_A=Value specified by the INIT_A attribute for output register. Default is all zeros.

Inputs								Outputs		
GSR	ENA	SSRA	WEA	CLKA	ADDRA	DIA	DIPA	DOA	DOPA	RAM Contents
									Data RAM	Parity RAM
<p>SRVAL_A=register value. addr=RAM address. RAM(addr)=RAM contents at address ADDR. data=RAM input data. pdata=RAM parity data. ¹WRITE_MODE_A=NO_CHANGE. ²WRITE_MODE_A=READ_FIRST. ³WRITE_MODE_A=WRITE_FIRST.</p>										

Truth Table B

Inputs								Outputs			
GSR	ENB	SSRB	WEB	CLKB	ADDRB	DIB	DIPB	DOB	DOPB	RAM Contents	
										Data RAM	Parity RAM
1	X	X	X	X	X	X	X	INIT_B	INIT_B	No Change	No Change
0	0	X	X	X	X	X	X	No Change	No Change	No Change	No Change
0	1	1	0	↑	X	X	X	SRVAL_B	SRVAL_B	No Change	No Change
0	1	1	1	↑	addr	data	pdata	SRVAL_B	SRVAL_B	RAM(addr) =>data	RAM(addr) =>pdata
0	1	0	0	↑	addr	X	X	RAM(addr)	RAM(addr)	No Change	No Change
0	1	0	1	↑	addr	data	pdata	No Change ¹ , RAM(addr) ² , data ³	No Change ¹ , RAM(addr) ² , pdata ³	RAM(addr) =>data	RAM(addr) =>pdata

GSR=Global Set Reset.
 INIT_B=Value specified by the INIT_B attribute for output registers. Default is all zeros.
 SRVAL_B=register value.
 addr=RAM address.
 RAM(addr)=RAM contents at address ADDR.
 data=RAM input data.
 pdata=RAM parity data.
¹WRITE_MODE_B=NO_CHANGE.
²WRITE_MODE_B=READ_FIRST.
³WRITE_MODE_B=WRITE_FIRST.

Port Descriptions

Port A						Port B				
Design Element	Data Cells ¹	Parity Cells ¹	Address Bus	Data Bus	Parity Bus	Data Cells ¹	Parity Cells ¹	Address Bus	Data Bus	Parity Bus
RAMB16_S9_S36	2048 x 8	2048 x 1	(10:0)	(7:0)	(0:0)	512 x 32	512 x 4	(8:0)	(31:0)	(3:0)

¹Depth x Width

Each port is fully synchronous with independent clock pins. All Port A input pins have setup time referenced to the CLKA pin and its data output bus DOA has a clock-to-out time referenced to the CLKA. All Port B input pins have setup time referenced to the CLKB pin and its data output bus DOB has a clock-to-out time referenced to the CLKB. The enable ENA pin controls read, write, and reset for Port A. When ENA is Low, no data is written and the outputs (DOA and DOPA) retain the last state. When ENA is High and reset (SSRA) is High, DOA and DOPA are set to SRVAL_A during the Low-to-High clock (CLKA) transition; if write enable (WEA) is High, the memory contents reflect the data at DIA and DIPA. When ENA is High and WEA is Low, the data stored in the RAM address (ADDRA) is read during the Low-to-High clock transition. By default, WRITE_MODE_A=WRITE_FIRST, when ENA and WEA are High, the data on the data inputs (DIA and DIPA) is loaded into the word selected by the write address (ADDRA) during the Low-to-High clock transition and the data outputs (DOA and DOPA) reflect the selected (addressed) word.

Initializing the Output Register of a Dual-Port RAMB16

In Spartan®-3A and above devices, each bit in an output register can be initialized at power on (when GSR is high) to either a 0 or 1. In addition, the initial state specified for power on can be different than the state that results from assertion of a set/reset. Four properties control initialization of the output register for a dual-port RAMB16: INIT_A, INIT_B, SRVAL_A, and SRVAL_B. The INIT_A attribute specifies the output register value at power on for Port A and the INIT_B attribute specifies the value for Port B. You can use the SRVAL_A attribute to define the state resulting from assertion of the SSR (set/reset) input on Port A. You can use the SRVAL_B attribute to define the state resulting from assertion of the SSR input on Port B.

The INIT_A, INIT_B, SRVAL_A, and SRVAL_B attributes specify the initialization value as a hexadecimal String. The value is dependent upon the port width. For example, for a RAMB16_S1_S4 with Port A width equal to 1 and Port B width equal to 4, the Port A output register contains 1 bit and the Port B output register contains 4 bits. Therefore, the INIT_A or SRVAL_A value can only be specified as a 1 or 0. For Port B, the output register contains 4 bits. In this case, you can use INIT_B or SRVAL_B to specify a hexadecimal value from 0 through F to initialize the 4 bits of the output register.

For those ports that include parity bits, the parity portion of the output register is specified in the high order bit position of the INIT_A, INIT_B, SRVAL_A, or SRVAL_B value.

The INIT and SRVAL attributes default to zero if they are not set by you.

Write Mode Selection

The WRITE_MODE_A attribute controls the memory and output contents of Port A for a dual-port RAMB16. The WRITE_MODE_B attribute does the same for Port B. By default, both WRITE_MODE_A and WRITE_MODE_B are set to WRITE_FIRST. This means that input is read, written to memory, and then passed to output. You can set the write mode for Port A and Port B to READ_FIRST to read the memory contents, pass the memory contents to the outputs, and then write the input to memory. Or, you can set the write mode to NO_CHANGE to have the input written to memory without changing the output. The Port A and Port B Conflict Resolution section describes how read/write conflicts are resolved when both Port A and Port B are attempting to read/write to the same memory cells.

Port A and Port B Conflict Resolution

Spartan-3A block SelectRAM™ is True Dual-Port RAM that allows both ports to simultaneously access the same memory cell. When one port writes to a given memory cell, the other port must not address that memory cell (for a write or a read) within the clock-to-clock setup window.

The following tables summarize the collision detection behavior of the dual-port RAMB16 based on the WRITE_MODE_A and WRITE_MODE_B settings.

WRITE_MODE_A=NO_CHANGE and WRITE_MODE_B=NO_CHANGE

WEA	WEB	CLKA	CLKB	DIA	DIB	DIPA	DIPB	DOA	DOB	DOPA	DOPB	Data RAM	Parity Ram
0	0	↑	↑	DIA	DIB	DIPA	DIPB	RAM	RAM	RAM	RAM	No Change	No Change
1	0	↑	↑	DIA	DIB	DIPA	DIPB	No Change	X	No Change	X	DIA	DIPA
0	1	↑	↑	DIA	DIB	DIPA	DIPB	X	No Change	X	No Change	DIB	DIPB
1	1	↑	↑	DIA	DIB	DIPA	DIPB	No Change	No Change	No Change	No Change	X	X

WRITE_MODE_A=READ_FIRST and WRITE_MODE_B=READ_FIRST

WEA	WEB	CLKA	CLKB	DIA	DIB	DIPA	DIPB	DOA	DOB	DOPA	DOPB	Data RAM	Parity Ram
0	0	↑	↑	DIA	DIB	DIPA	DIPB	RAM	RAM	RAM	RAM	No Change	No Change
1	0	↑	↑	DIA	DIB	DIPA	DIPB	RAM	RAM	RAM	RAM	DIA	DIPA
0	1	↑	↑	DIA	DIB	DIPA	DIPB	RAM	RAM	RAM	RAM	DIB	DIPB
1	1	↑	↑	DIA	DIB	DIPA	DIPB	RAM	RAM	RAM	RAM	X	X

WRITE_MODE_A= WRITE_FIRST and WRITE_MODE_B=WRITE_FIRST

WEA	WEB	CLKA	CLKB	DIA	DIB	DIPA	DIPB	DOA	DOB	DOPA	DOPB	Data RAM	Parity Ram
0	0	↑	↑	DIA	DIB	DIPA	DIPB	RAM	RAM	RAM	RAM	No Change	No Change
1	0	↑	↑	DIA	DIB	DIPA	DIPB	DIA	X	DIPA	X	DIA	DIPA
0	1	↑	↑	DIA	DIB	DIPA	DIPB	X	DIB	X	DIPB	DIB	DIPB
1	1	↑	↑	DIA	DIB	DIPA	DIPB	X	X	X	X	X	X

WRITE_MODE_A=NO_CHANGE and WRITE_MODE_B=READ_FIRST

WEA	WEB	CLKA	CLKB	DIA	DIB	DIPA	DIPB	DOA	DOB	DOPA	DOPB	Data RAM	Parity Ram
0	0	↑	↑	DIA	DIB	DIPA	DIPB	RAM	RAM	RAM	RAM	No Change	No Change
1	0	↑	↑	DIA	DIB	DIPA	DIPB	No Change	X	No Change	X	DIA	DIPA
0	1	↑	↑	DIA	DIB	DIPA	DIPB	RAM	RAM	RAM	RAM	DIB	DIPB
1	1	↑	↑	DIA	DIB	DIPA	DIPB	No Change	X	No Change	X	DIB	DIPB

WRITE_MODE_A=NO_CHANGE and WRITE_MODE_B=WRITE_FIRST

WEA	WEB	CLKA	CLKB	DIA	DIB	DIPA	DIPB	DOA	DOB	DOPA	DOPB	Data RAM	Parity Ram
0	0	↑	↑	DIA	DIB	DIPA	DIPB	RAM	RAM	RAM	RAM	No Change	No Change
1	0	↑	↑	DIA	DIB	DIPA	DIPB	No Change	X	No Change	X	DIA	DIPA
0	1	↑	↑	DIA	DIB	DIPA	DIPB	X	DIB	X	DIPB	DIB	DIPB
1	1	↑	↑	DIA	DIB	DIPA	DIPB	No Change	X	No Change	X	X	X

WRITE_MODE_A=READ_FIRST and WRITE_MODE_B=WRITE_FIRST

WEA	WEB	CLKA	CLKB	DIA	DIB	DIPA	DIPB	DOA	DOB	DOPA	DOPB	Data RAM	Parity Ram
0	0	↑	↑	DIA	DIB	DIPA	DIPB	RAM	RAM	RAM	RAM	No Change	No Change
1	0	↑	↑	DIA	DIB	DIPA	DIPB	RAM	RAM	RAM	RAM	DIA	DIPA

WEA	WEB	CLKA	CLKB	DIA	DIB	DIPA	DIPB	DOA	DOB	DOPA	DOPB	Data RAM	Parity Ram
0	1	↑	↑	DIA	DIB	DIPA	DIPB	X	DIB	X	DIPB	DIB	DIPB
1	1	↑	↑	DIA	DIB	DIPA	DIPB	X	DIB	X	DIPB	DIA	DIPA

Design Entry Method

This design element can be used in schematics.

Available Attributes

Attribute	Data Type	Allowed Values	Default	Description
INIT_00 to INIT_3F	Binary/ Hexadecimal	Any	All zeros	Specifies the initial contents of the data portion of the RAM array.
INIT_A	Binary/ Hexadecimal	Any	All zeros	Specifies the initial value of the DOA output port after completing configuration. For Type, the bit width is dependent on the width of the A port of the RAM.
INIT_B	Binary/ Hexadecimal	Any	All zeros	Specifies the initial value of the DOB output port after completing configuration. For Type, the bit width is dependent on the width of the B port of the RAM.
INITP_00 to INITP_07	Binary/ Hexadecimal	Any	All zeros	Specifies the initial contents of the parity portion of the RAM array.
SIM_COLLISION_CHECK	String	"ALL", "WARNING_ONLY", "GENERATE_X_ONLY", "NONE"	"ALL"	<p>Allows modification of the simulation behavior if a memory collision occurs. The output is affected as follows:</p> <ul style="list-style-type: none"> "ALL" - Warning produced and affected outputs/memory location go unknown (X). "WARNING_ONLY" - Warning produced and affected outputs/memory retain last value. "GENERATE_X_ONLY" - No warning. However, affected outputs/memory go unknown (X). "NONE" - No warning and affected outputs/memory retain last value. <p>Note Setting this to a value other than "ALL" can allow problems in the design go unnoticed during simulation. Care should be taken when changing the value of this attribute. Please see the <i>Synthesis and Simulation Design Guide</i> for more information.</p>
SRVAL_A	Binary/ Hexadecimal	Any	All zeros	Sets on a per-bit basis whether the DOA output port sets (goes to a one) or resets (goes to a zero) upon the assertion of the RSTA pin. For Type, the bit width is dependent on the width of the A port of the RAM. Default is all bits reset.
SRVAL_B	Binary/ Hexadecimal	Any	All zeros	Sets on a per-bit basis whether the DOB output port sets (goes to a one) or resets (goes to a zero) upon the assertion of the RSTB pin. For Type, the bit width is dependent on the width of the B port of the RAM. Default is all bits reset.

Attribute	Data Type	Allowed Values	Default	Description
WRITE_MODE_A	String	"WRITE_FIRST", "READ_FIRST", "NO_CHANGE"	"WRITE_FIRST"	<p>Specifies the behavior of the DOA port upon a write command to the port.</p> <ul style="list-style-type: none"> "WRITE_FIRST" - the same port that is written to displays the contents of the written data to the outputs upon completion of the operation. "READ_FIRST" - displays the prior contents of the RAM to the output port prior to writing the new data. "NO_CHANGE" - keeps the previous value on the output port and does not update the output port upon a write command. This is the suggested mode if not using the read data from a particular port of the RAM.
WRITE_MODE_B	String	"WRITE_FIRST", "READ_FIRST", "NO_CHANGE"	"WRITE_FIRST"	<p>Specifies the behavior of the DOB port upon a write command to the port.</p> <ul style="list-style-type: none"> "WRITE_FIRST" - the same port that is written to displays the contents of the written data to the outputs upon completion of the operation. "READ_FIRST" - displays the prior contents of the RAM to the output port prior to writing the new data. "NO_CHANGE" - keeps the previous value on the output port and does not update the output port upon a write command. This is the suggested mode if not using the read data from a particular port of the RAM.

For More Information

- See the [Spartan-3 Generation FPGA User Guide \(UG331\)](#).
- See the [Spartan-3E FPGA Family Data Sheet \(DS312\)](#).

RAMB16_S9_S9

Primitive: 16K-bit Data and 2K-bit Parity Dual-Port Synchronous Block RAM with 9-bit Ports

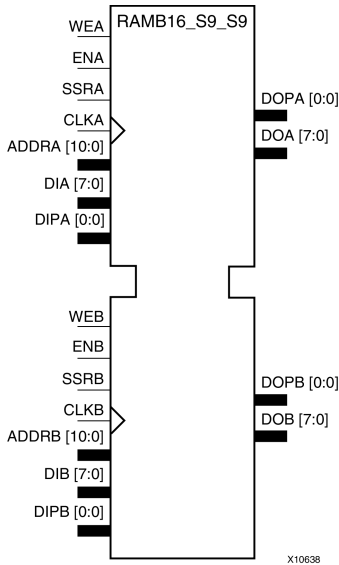

Introduction

This design element is a dual-ported dedicated random access memory block with synchronous write capability. Each block RAM port has 16384 bits of data memory. Ports configured as 9, 18, or 36 bits wide have an additional 2048 bits of parity memory. Each port is independent of the other while accessing the same set of 16384 data memory cells. Each port is independently configured to a specific data width. The possible port and cell configurations for this element are listed in the "Port Descriptions" section.

Logic Table

Truth Table A

Inputs								Outputs			
GSR	ENA	SSRA	WEA	CLKA	ADDRa	DIA	DIPA	DOA	DOPA	RAM Contents	
										Data RAM	Parity RAM
1	X	X	X	X	X	X	X	INIT_A	INIT_A	No Change	No Change
0	0	X	X	X	X	X	X	No Change	No Change	No Change	No Change
0	1	1	0	↑	X	X	X	SRVAL_A	SRVAL_A	No Change	No Change
0	1	1	1	↑	addr	data	pdata	SRVAL_A	SRVAL_A	RAM(addr) =>data	RAM(addr) =>pdata
0	1	0	0	↑	addr	X	X	RAM(addr)	RAM(addr)	No Change	No Change
0	1	0	1	↑	addr	data	pdata	No Change ¹ , RAM(addr) ² , data ³	No Change ¹ , RAM(addr) ² , pdata ³	RAM(addr) =>data	RAM(addr) =>pdata

GSR=Global Set Reset.

INIT_A=Value specified by the INIT_A attribute for output register. Default is all zeros.

SRVAL_A=register value.

Inputs								Outputs				
GSR	ENA	SSRA	WEA	CLKA	ADDRA	DIA	DIPA	DOA	DOPA	RAM Contents		
											Data RAM	Parity RAM
<p>addr=RAM address. RAM(addr)=RAM contents at address ADDR. data=RAM input data. pdata=RAM parity data. ¹WRITE_MODE_A=NO_CHANGE. ²WRITE_MODE_A=READ_FIRST. ³WRITE_MODE_A=WRITE_FIRST.</p>												

Truth Table B

Inputs								Outputs			
GSR	ENB	SSRB	WEB	CLKB	ADDRB	DIB	DIPB	DOB	DOPB	RAM Contents	
										Data RAM	Parity RAM
1	X	X	X	X	X	X	X	INIT_B	INIT_B	No Change	No Change
0	0	X	X	X	X	X	X	No Change	No Change	No Change	No Change
0	1	1	0	↑	X	X	X	SRVAL_B	SRVAL_B	No Change	No Change
0	1	1	1	↑	addr	data	pdata	SRVAL_B	SRVAL_B	RAM(addr) =>data	RAM(addr) =>pdata
0	1	0	0	↑	addr	X	X	RAM(addr)	RAM(addr)	No Change	No Change
0	1	0	1	↑	addr	data	pdata	No Change ¹ , RAM(addr) ² , data ³	No Change ¹ , RAM(addr) ² , pdata ³	RAM(addr) =>data	RAM(addr) =>pdata

GSR=Global Set Reset.

INIT_B=Value specified by the INIT_B attribute for output registers. Default is all zeros.

SRVAL_B=register value.

addr=RAM address.

RAM(addr)=RAM contents at address ADDR.

data=RAM input data.

pdata=RAM parity data.

¹WRITE_MODE_B=NO_CHANGE.

²WRITE_MODE_B=READ_FIRST.

³WRITE_MODE_B=WRITE_FIRST.

Port Descriptions

Port A						Port B				
Design Element	Data Cells ¹	Parity Cells ¹	Address Bus	Data Bus	Parity Bus	Data Cells ¹	Parity Cells ¹	Address Bus	Data Bus	Parity Bus
RAMB16_S9_S9	2048 x 8	2048 x 1	(10:0)	(7:0)	(0:0)	2048 x 8	2048 x 1	(10:0)	(7:0)	(0:0)

¹Depth x Width

Each port is fully synchronous with independent clock pins. All Port A input pins have setup time referenced to the CLKA pin and its data output bus DOA has a clock-to-out time referenced to the CLKA. All Port B input pins have setup time referenced to the CLKB pin and its data output bus DOB has a clock-to-out time referenced to the CLKB. The enable ENA pin controls read, write, and reset for Port A. When ENA is Low, no data is written and the outputs (DOA and DOPA) retain the last state. When ENA is High and reset (SSRA) is High, DOA and DOPA are set to SRVAL_A during the Low-to-High clock (CLKA) transition; if write enable (WEA) is High, the memory contents reflect the data at DIA and DIPA. When ENA is High and WEA is Low, the data stored in the RAM address (ADDRA) is read during the Low-to-High clock transition. By default, WRITE_MODE_A=WRITE_FIRST, when ENA and WEA are High, the data on the data inputs (DIA and DIPA) is loaded into the word selected by the write address (ADDRA) during the Low-to-High clock transition and the data outputs (DOA and DOPA) reflect the selected (addressed) word.

Initializing the Output Register of a Dual-Port RAMB16

In Spartan®-3A and above devices, each bit in an output register can be initialized at power on (when GSR is high) to either a 0 or 1. In addition, the initial state specified for power on can be different than the state that results from assertion of a set/reset. Four properties control initialization of the output register for a dual-port RAMB16: INIT_A, INIT_B, SRVAL_A, and SRVAL_B. The INIT_A attribute specifies the output register value at power on for Port A and the INIT_B attribute specifies the value for Port B. You can use the SRVAL_A attribute to define the state resulting from assertion of the SSR (set/reset) input on Port A. You can use the SRVAL_B attribute to define the state resulting from assertion of the SSR input on Port B.

The INIT_A, INIT_B, SRVAL_A, and SRVAL_B attributes specify the initialization value as a hexadecimal String. The value is dependent upon the port width. For example, for a RAMB16_S1_S4 with Port A width equal to 1 and Port B width equal to 4, the Port A output register contains 1 bit and the Port B output register contains 4 bits. Therefore, the INIT_A or SRVAL_A value can only be specified as a 1 or 0. For Port B, the output register contains 4 bits. In this case, you can use INIT_B or SRVAL_B to specify a hexadecimal value from 0 through F to initialize the 4 bits of the output register.

For those ports that include parity bits, the parity portion of the output register is specified in the high order bit position of the INIT_A, INIT_B, SRVAL_A, or SRVAL_B value.

The INIT and SRVAL attributes default to zero if they are not set by you.

Write Mode Selection

The WRITE_MODE_A attribute controls the memory and output contents of Port A for a dual-port RAMB16. The WRITE_MODE_B attribute does the same for Port B. By default, both WRITE_MODE_A and WRITE_MODE_B are set to WRITE_FIRST. This means that input is read, written to memory, and then passed to output. You can set the write mode for Port A and Port B to READ_FIRST to read the memory contents, pass the memory contents to the outputs, and then write the input to memory. Or, you can set the write mode to NO_CHANGE to have the input written to memory without changing the output. The Port A and Port B Conflict Resolution section describes how read/write conflicts are resolved when both Port A and Port B are attempting to read/write to the same memory cells.

Port A and Port B Conflict Resolution

Spartan-3A block SelectRAM™ is True Dual-Port RAM that allows both ports to simultaneously access the same memory cell. When one port writes to a given memory cell, the other port must not address that memory cell (for a write or a read) within the clock-to-clock setup window.

The following tables summarize the collision detection behavior of the dual-port RAMB16 based on the WRITE_MODE_A and WRITE_MODE_B settings.

WRITE_MODE_A=NO_CHANGE and WRITE_MODE_B=NO_CHANGE

WEA	WEB	CLKA	CLKB	DIA	DIB	DIPA	DIPB	DOA	DOB	DOPA	DOPB	Data RAM	Parity Ram
0	0	↑	↑	DIA	DIB	DIPA	DIPB	RAM	RAM	RAM	RAM	No Change	No Change
1	0	↑	↑	DIA	DIB	DIPA	DIPB	No Change	X	No Change	X	DIA	DIPA
0	1	↑	↑	DIA	DIB	DIPA	DIPB	X	No Change	X	No Change	DIB	DIPB
1	1	↑	↑	DIA	DIB	DIPA	DIPB	No Change	No Change	No Change	No Change	X	X

WRITE_MODE_A=READ_FIRST and WRITE_MODE_B=READ_FIRST

WEA	WEB	CLKA	CLKB	DIA	DIB	DIPA	DIPB	DOA	DOB	DOPA	DOPB	Data RAM	Parity Ram
0	0	↑	↑	DIA	DIB	DIPA	DIPB	RAM	RAM	RAM	RAM	No Change	No Change
1	0	↑	↑	DIA	DIB	DIPA	DIPB	RAM	RAM	RAM	RAM	DIA	DIPA
0	1	↑	↑	DIA	DIB	DIPA	DIPB	RAM	RAM	RAM	RAM	DIB	DIPB
1	1	↑	↑	DIA	DIB	DIPA	DIPB	RAM	RAM	RAM	RAM	X	X

WRITE_MODE_A= WRITE_FIRST and WRITE_MODE_B=WRITE_FIRST

WEA	WEB	CLKA	CLKB	DIA	DIB	DIPA	DIPB	DOA	DOB	DOPA	DOPB	Data RAM	Parity Ram
0	0	↑	↑	DIA	DIB	DIPA	DIPB	RAM	RAM	RAM	RAM	No Change	No Change
1	0	↑	↑	DIA	DIB	DIPA	DIPB	DIA	X	DIPA	X	DIA	DIPA
0	1	↑	↑	DIA	DIB	DIPA	DIPB	X	DIB	X	DIPB	DIB	DIPB
1	1	↑	↑	DIA	DIB	DIPA	DIPB	X	X	X	X	X	X

WRITE_MODE_A=NO_CHANGE and WRITE_MODE_B=READ_FIRST

WEA	WEB	CLKA	CLKB	DIA	DIB	DIPA	DIPB	DOA	DOB	DOPA	DOPB	Data RAM	Parity Ram
0	0	↑	↑	DIA	DIB	DIPA	DIPB	RAM	RAM	RAM	RAM	No Change	No Change
1	0	↑	↑	DIA	DIB	DIPA	DIPB	No Change	X	No Change	X	DIA	DIPA
0	1	↑	↑	DIA	DIB	DIPA	DIPB	RAM	RAM	RAM	RAM	DIB	DIPB
1	1	↑	↑	DIA	DIB	DIPA	DIPB	No Change	X	No Change	X	DIB	DIPB

WRITE_MODE_A=NO_CHANGE and WRITE_MODE_B=WRITE_FIRST

WEA	WEB	CLKA	CLKB	DIA	DIB	DIPA	DIPB	DOA	DOB	DOPA	DOPB	Data RAM	Parity Ram
0	0	↑	↑	DIA	DIB	DIPA	DIPB	RAM	RAM	RAM	RAM	No Change	No Change
1	0	↑	↑	DIA	DIB	DIPA	DIPB	No Change	X	No Change	X	DIA	DIPA
0	1	↑	↑	DIA	DIB	DIPA	DIPB	X	DIB	X	DIPB	DIB	DIPB
1	1	↑	↑	DIA	DIB	DIPA	DIPB	No Change	X	No Change	X	X	X

WRITE_MODE_A=READ_FIRST and WRITE_MODE_B=WRITE_FIRST

WEA	WEB	CLKA	CLKB	DIA	DIB	DIPA	DIPB	DOA	DOB	DOPA	DOPB	Data RAM	Parity Ram
0	0	↑	↑	DIA	DIB	DIPA	DIPB	RAM	RAM	RAM	RAM	No Change	No Change
1	0	↑	↑	DIA	DIB	DIPA	DIPB	RAM	RAM	RAM	RAM	DIA	DIPA

WEA	WEB	CLKA	CLKB	DIA	DIB	DIPA	DIPB	DOA	DOB	DOPA	DOPB	Data RAM	Parity Ram
0	1	↑	↑	DIA	DIB	DIPA	DIPB	X	DIB	X	DIPB	DIB	DIPB
1	1	↑	↑	DIA	DIB	DIPA	DIPB	X	DIB	X	DIPB	DIA	DIPA

Design Entry Method

This design element can be used in schematics.

Available Attributes

Attribute	Data Type	Allowed Values	Default	Description
INIT_00 to INIT_3F	Binary/Hexadecimal	Any	All zeros	Specifies the initial contents of the data portion of the RAM array.
INIT_A	Binary/Hexadecimal	Any	All zeros	Specifies the initial value of the DOA output port after completing configuration. For Type, the bit width is dependent on the width of the A port of the RAM.
INIT_B	Binary/Hexadecimal	Any	All zeros	Specifies the initial value of the DOB output port after completing configuration. For Type, the bit width is dependent on the width of the B port of the RAM.
INITP_00 to INITP_07	Binary/Hexadecimal	Any	All zeros	Specifies the initial contents of the parity portion of the RAM array.
SIM_COLLISION_CHECK	String	"ALL", "WARNING_ONLY", "GENERATE_X_ONLY", "NONE"	"ALL"	<p>Allows modification of the simulation behavior if a memory collision occurs. The output is affected as follows:</p> <ul style="list-style-type: none"> "ALL" - Warning produced and affected outputs/memory location go unknown (X). "WARNING_ONLY" - Warning produced and affected outputs/memory retain last value. "GENERATE_X_ONLY" - No warning. However, affected outputs/memory go unknown (X). "NONE" - No warning and affected outputs/memory retain last value. <p>Note Setting this to a value other than "ALL" can allow problems in the design go unnoticed during simulation. Care should be taken when changing the value of this attribute. Please see the <i>Synthesis and Simulation Design Guide</i> for more information.</p>
SRVAL_A	Binary/Hexadecimal	Any	All zeros	Sets on a per-bit basis whether the DOA output port sets (goes to a one) or resets (goes to a zero) upon the assertion of the RSTA pin. For Type, the bit width is dependent on the width of the A port of the RAM. Default is all bits reset.
SRVAL_B	Binary/Hexadecimal	Any	All zeros	Sets on a per-bit basis whether the DOB output port sets (goes to a one) or resets (goes to a zero) upon the assertion of the RSTB pin. For Type, the bit width is dependent on the width of the B port of the RAM. Default is all bits reset.

Attribute	Data Type	Allowed Values	Default	Description
WRITE_MODE_A	String	"WRITE_FIRST", "READ_FIRST", "NO_CHANGE"	"WRITE_FIRST"	<p>Specifies the behavior of the DOA port upon a write command to the port.</p> <ul style="list-style-type: none"> "WRITE_FIRST" - the same port that is written to displays the contents of the written data to the outputs upon completion of the operation. "READ_FIRST" - displays the prior contents of the RAM to the output port prior to writing the new data. "NO_CHANGE" - keeps the previous value on the output port and does not update the output port upon a write command. This is the suggested mode if not using the read data from a particular port of the RAM.
WRITE_MODE_B	String	"WRITE_FIRST", "READ_FIRST", "NO_CHANGE"	"WRITE_FIRST"	<p>Specifies the behavior of the DOB port upon a write command to the port.</p> <ul style="list-style-type: none"> "WRITE_FIRST" - the same port that is written to displays the contents of the written data to the outputs upon completion of the operation. "READ_FIRST" - displays the prior contents of the RAM to the output port prior to writing the new data. "NO_CHANGE" - keeps the previous value on the output port and does not update the output port upon a write command. This is the suggested mode if not using the read data from a particular port of the RAM.

For More Information

- See the [Spartan-3 Generation FPGA User Guide \(UG331\)](#).
- See the [Spartan-3E FPGA Family Data Sheet \(DS312\)](#).

ROM128X1

Primitive: 128-Deep by 1-Wide ROM

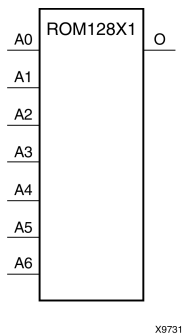

Introduction

This design element is a 128-word by 1-bit read-only memory. The data output (O) reflects the word selected by the 7-bit address (A6:A0). The ROM is initialized to a known value during configuration with the INIT=value parameter. The value consists of 32 hexadecimal digits that are written into the ROM from the most-significant digit A=FH to the least-significant digit A=0H. An error occurs if the INIT=value is not specified.

Logic Table

Input				Output
I0	I1	I2	I3	O
0	0	0	0	INIT(0)
0	0	0	1	INIT(1)
0	0	1	0	INIT(2)
0	0	1	1	INIT(3)
0	1	0	0	INIT(4)
0	1	0	1	INIT(5)
0	1	1	0	INIT(6)
0	1	1	1	INIT(7)
1	0	0	0	INIT(8)
1	0	0	1	INIT(9)
1	0	1	0	INIT(10)
1	0	1	1	INIT(11)
1	1	0	0	INIT(12)
1	1	0	1	INIT(13)
1	1	1	0	INIT(14)
1	1	1	1	INIT(15)

Design Entry Method

This design element can be used in schematics.

Available Attributes

Attribute	Data Type	Allowed Values	Default	Description
INIT	Hexadecimal	Any 128-Bit Value	All zeros	Specifies the contents of the ROM.

For More Information

- See the [Spartan-3 Generation FPGA User Guide \(UG331\)](#).
- See the [Spartan-3E FPGA Family Data Sheet \(DS312\)](#).

ROM16X1

Primitive: 16-Deep by 1-Wide ROM

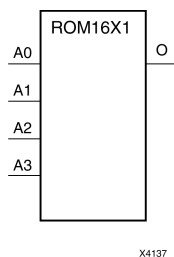

Introduction

This design element is a 16-word by 1-bit read-only memory. The data output (O) reflects the word selected by the 4-bit address (A3:A0). The ROM is initialized to a known value during configuration with the INIT=value parameter. The value consists of four hexadecimal digits that are written into the ROM from the most-significant digit A=FH to the least-significant digit A=0H. For example, the INIT=10A7 parameter produces the data stream: 0001 0000 1010 0111. An error occurs if the INIT=value is not specified.

Logic Table

Input				Output
I0	I1	I2	I3	O
0	0	0	0	INIT(0)
0	0	0	1	INIT(1)
0	0	1	0	INIT(2)
0	0	1	1	INIT(3)
0	1	0	0	INIT(4)
0	1	0	1	INIT(5)
0	1	1	0	INIT(6)
0	1	1	1	INIT(7)
1	0	0	0	INIT(8)
1	0	0	1	INIT(9)
1	0	1	0	INIT(10)
1	0	1	1	INIT(11)
1	1	0	0	INIT(12)
1	1	0	1	INIT(13)
1	1	1	0	INIT(14)
1	1	1	1	INIT(15)

Design Entry Method

This design element can be used in schematics.

Available Attributes

Attribute	Data Type	Allowed Values	Default	Description
INIT	Hexadecimal	Any 16-Bit Value	All zeros	Specifies the contents of the ROM.

For More Information

- See the [Spartan-3 Generation FPGA User Guide \(UG331\)](#).
- See the [Spartan-3E FPGA Family Data Sheet \(DS312\)](#).

ROM256X1

Primitive: 256-Deep by 1-Wide ROM

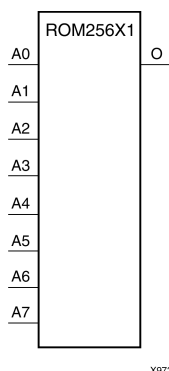

Introduction

This design element is a 256-word by 1-bit read-only memory. The data output (O) reflects the word selected by the 8-bit address (A7:A0). The ROM is initialized to a known value during configuration with the INIT=value parameter. The value consists of 64 hexadecimal digits that are written into the ROM from the most-significant digit A=FH to the least-significant digit A=0H.

An error occurs if the INIT=value is not specified.

Logic Table

Input				Output
I0	I1	I2	I3	O
0	0	0	0	INIT(0)
0	0	0	1	INIT(1)
0	0	1	0	INIT(2)
0	0	1	1	INIT(3)
0	1	0	0	INIT(4)
0	1	0	1	INIT(5)
0	1	1	0	INIT(6)
0	1	1	1	INIT(7)
1	0	0	0	INIT(8)
1	0	0	1	INIT(9)
1	0	1	0	INIT(10)
1	0	1	1	INIT(11)
1	1	0	0	INIT(12)
1	1	0	1	INIT(13)
1	1	1	0	INIT(14)
1	1	1	1	INIT(15)

Design Entry Method

This design element can be used in schematics.

Available Attributes

Attribute	Data Type	Allowed Values	Default	Description
INIT	Hexadecimal	Any 256-Bit Value	All zeros	Specifies the contents of the ROM.

For More Information

- See the [Spartan-3 Generation FPGA User Guide \(UG331\)](#).
- See the [Spartan-3E FPGA Family Data Sheet \(DS312\)](#).

ROM32X1

Primitive: 32-Deep by 1-Wide ROM

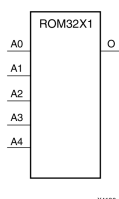

Introduction

This design element is a 32-word by 1-bit read-only memory. The data output (O) reflects the word selected by the 5-bit address (A4:A0). The ROM is initialized to a known value during configuration with the INIT=value parameter. The value consists of eight hexadecimal digits that are written into the ROM from the most-significant digit A=1FH to the least-significant digit A=00H.

For example, the INIT=10A78F39 parameter produces the data stream: 0001 0000 1010 0111 1000 1111 0011 1001. An error occurs if the INIT=value is not specified.

Logic Table

Input				Output
I0	I1	I2	I3	O
0	0	0	0	INIT(0)
0	0	0	1	INIT(1)
0	0	1	0	INIT(2)
0	0	1	1	INIT(3)
0	1	0	0	INIT(4)
0	1	0	1	INIT(5)
0	1	1	0	INIT(6)
0	1	1	1	INIT(7)
1	0	0	0	INIT(8)
1	0	0	1	INIT(9)
1	0	1	0	INIT(10)
1	0	1	1	INIT(11)
1	1	0	0	INIT(12)
1	1	0	1	INIT(13)
1	1	1	0	INIT(14)
1	1	1	1	INIT(15)

Design Entry Method

This design element can be used in schematics.

Available Attributes

Attribute	Type	Allowed Values	Default	Description
INIT	Hexadecimal	Any 32-Bit Value	All zeros	Specifies the contents of the ROM.

For More Information

- See the [Spartan-3 Generation FPGA User Guide \(UG331\)](#).
- See the [Spartan-3E FPGA Family Data Sheet \(DS312\)](#).

ROM64X1

Primitive: 64-Deep by 1-Wide ROM

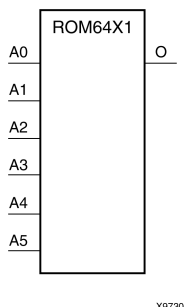

Introduction

This design element is a 64-word by 1-bit read-only memory. The data output (O) reflects the word selected by the 6-bit address (A5:A0). The ROM is initialized to a known value during configuration with the INIT=value parameter. The value consists of 16 hexadecimal digits that are written into the ROM from the most-significant digit A=FH to the least-significant digit A=0H. An error occurs if the INIT=value is not specified.

Logic Table

Input				Output
I0	I1	I2	I3	O
0	0	0	0	INIT(0)
0	0	0	1	INIT(1)
0	0	1	0	INIT(2)
0	0	1	1	INIT(3)
0	1	0	0	INIT(4)
0	1	0	1	INIT(5)
0	1	1	0	INIT(6)
0	1	1	1	INIT(7)
1	0	0	0	INIT(8)
1	0	0	1	INIT(9)
1	0	1	0	INIT(10)
1	0	1	1	INIT(11)
1	1	0	0	INIT(12)
1	1	0	1	INIT(13)
1	1	1	0	INIT(14)
1	1	1	1	INIT(15)

Design Entry Method

This design element can be used in schematics.

Available Attributes

Attribute	Data Type	Allowed Values	Default	Description
INIT	Hexadecimal	Any 64-Bit Value	All zeros	Specifies the contents of the ROM.

For More Information

- See the [Spartan-3 Generation FPGA User Guide \(UG331\)](#).
- See the [Spartan-3E FPGA Family Data Sheet \(DS312\)](#).

SOP3

Macro: 3-Input Sum of Products

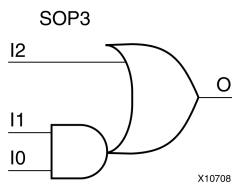

Introduction

Three input Sum of Products (SOP) macros provide common logic functions by OR gating the output of one AND function with one direct input. Variations of inverting and non-inverting inputs are available.

Design Entry Method

This design element is only for use in schematics.

For More Information

- See the [Spartan-3 Generation FPGA User Guide \(UG331\)](#).
- See the [Spartan-3E FPGA Family Data Sheet \(DS312\)](#).

SOP3B1A

Macro: 3–Input Sum of Products with One Inverted Input (Option A)

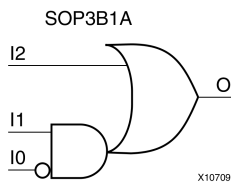

Introduction

Three input Sum of Products (SOP) macros provide common logic functions by OR gating the output of one AND function with one direct input. Variations of inverting and non-inverting inputs are available.

Design Entry Method

This design element is only for use in schematics.

For More Information

- See the [Spartan-3 Generation FPGA User Guide \(UG331\)](#).
- See the [Spartan-3E FPGA Family Data Sheet \(DS312\)](#).

SOP3B1B

Macro: 3-Input Sum of Products with One Inverted Input (Option B)

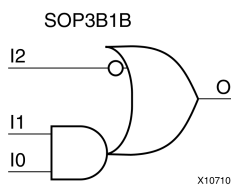

Introduction

Three input Sum of Products (SOP) macros provide common logic functions by OR gating the output of one AND function with one direct input. Variations of inverting and non-inverting inputs are available.

Design Entry Method

This design element is only for use in schematics.

For More Information

- See the [Spartan-3 Generation FPGA User Guide \(UG331\)](#).
- See the [Spartan-3E FPGA Family Data Sheet \(DS312\)](#).

SOP3B2A

Macro: 3-Input Sum of Products with Two Inverted Inputs (Option A)

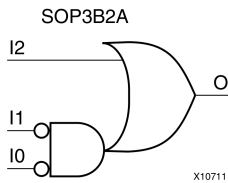

Introduction

Three input Sum of Products (SOP) macros provide common logic functions by OR gating the output of one AND function with one direct input. Variations of inverting and non-inverting inputs are available.

Design Entry Method

This design element is only for use in schematics.

For More Information

- See the [Spartan-3 Generation FPGA User Guide \(UG331\)](#).
- See the [Spartan-3E FPGA Family Data Sheet \(DS312\)](#).

SOP3B2B

Macro: 3–Input Sum of Products with Two Inverted Inputs (Option B)

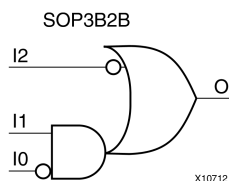

Introduction

Three input Sum of Products (SOP) macros provide common logic functions by OR gating the output of one AND function with one direct input. Variations of inverting and non-inverting inputs are available.

Design Entry Method

This design element is only for use in schematics.

For More Information

- See the [Spartan-3 Generation FPGA User Guide \(UG331\)](#).
- See the [Spartan-3E FPGA Family Data Sheet \(DS312\)](#).

SOP3B3

Macro: 3-Input Sum of Products with Inverted Inputs

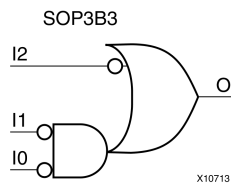

Introduction

Three input Sum of Products (SOP) macros provide common logic functions by OR gating the output of one AND function with one direct input. Variations of inverting and non-inverting inputs are available.

Design Entry Method

This design element is only for use in schematics.

For More Information

- See the [Spartan-3 Generation FPGA User Guide \(UG331\)](#).
- See the [Spartan-3E FPGA Family Data Sheet \(DS312\)](#).

SOP4

Macro: 4-Input Sum of Products

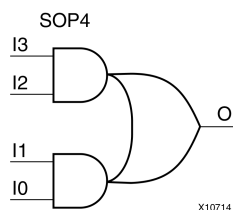

Introduction

Four input Sum of Products (SOP) macros provide common logic functions by OR gating the outputs of two AND functions. Variations of inverting and non-inverting inputs are available.

Design Entry Method

This design element is only for use in schematics.

For More Information

- See the [Spartan-3 Generation FPGA User Guide \(UG331\)](#).
- See the [Spartan-3E FPGA Family Data Sheet \(DS312\)](#).

SOP4B1

Macro: 4–Input Sum of Products with One Inverted Input

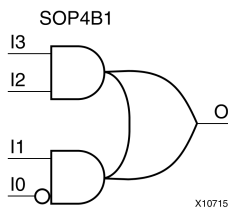

Introduction

Four input Sum of Products (SOP) macros provide common logic functions by OR gating the outputs of two AND functions. Variations of inverting and non-inverting inputs are available.

Design Entry Method

This design element is only for use in schematics.

For More Information

- See the [Spartan-3 Generation FPGA User Guide \(UG331\)](#).
- See the [Spartan-3E FPGA Family Data Sheet \(DS312\)](#).

SOP4B2A

Macro: 4–Input Sum of Products with Two Inverted Inputs (Option A)

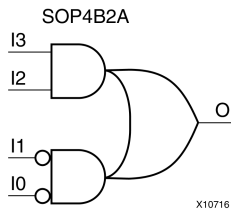

Introduction

Four input Sum of Products (SOP) macros provide common logic functions by OR gating the outputs of two AND functions. Variations of inverting and non-inverting inputs are available.

Design Entry Method

This design element is only for use in schematics.

For More Information

- See the [Spartan-3 Generation FPGA User Guide \(UG331\)](#).
- See the [Spartan-3E FPGA Family Data Sheet \(DS312\)](#).

SOP4B2B

Macro: 4–Input Sum of Products with Two Inverted Inputs (Option B)

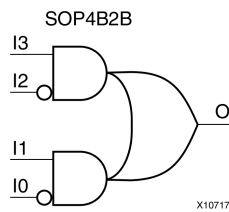

Introduction

Four input Sum of Products (SOP) macros provide common logic functions by OR gating the outputs of two AND functions. Variations of inverting and non-inverting inputs are available.

Design Entry Method

This design element is only for use in schematics.

For More Information

- See the [Spartan-3 Generation FPGA User Guide \(UG331\)](#).
- See the [Spartan-3E FPGA Family Data Sheet \(DS312\)](#).

SOP4B3

Macro: 4–Input Sum of Products with Three Inverted Inputs

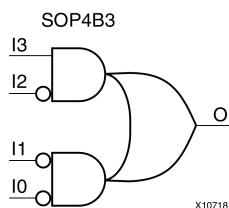

Introduction

Four input Sum of Products (SOP) macros provide common logic functions by OR gating the outputs of two AND functions. Variations of inverting and non-inverting inputs are available.

Design Entry Method

This design element is only for use in schematics.

For More Information

- See the [Spartan-3 Generation FPGA User Guide \(UG331\)](#).
- See the [Spartan-3E FPGA Family Data Sheet \(DS312\)](#).

SOP4B4

Macro: 4-Input Sum of Products with Inverted Inputs

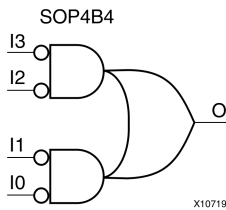

Introduction

Four input Sum of Products (SOP) macros provide common logic functions by OR gating the outputs of two AND functions. Variations of inverting and non-inverting inputs are available.

Design Entry Method

This design element is only for use in schematics.

For More Information

- See the [Spartan-3 Generation FPGA User Guide \(UG331\)](#).
- See the [Spartan-3E FPGA Family Data Sheet \(DS312\)](#).

SR16CE

Macro: 16-Bit Serial-In Parallel-Out Shift Register with Clock Enable and Asynchronous Clear

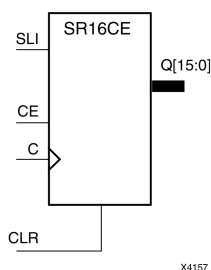

Introduction

This design element is a shift register with a shift-left serial input (SLI), parallel outputs (Q), and clock enable (CE) and asynchronous clear (CLR) inputs. The (CLR) input, when High, overrides all other inputs and resets the data outputs (Q) Low. When (CE) is High and (CLR) is Low, the data on the SLI input is loaded into the first bit of the shift register during the Low-to-High clock (C) transition and appears on the (Q0) output. During subsequent Low-to-High clock transitions, when (CE) is High and (CLR) is Low, data shifts to the next highest bit position as new data is loaded into (Q0) (SLI into Q0, Q0 into Q1, Q1 into Q2, and so forth). The register ignores clock transitions when (CE) is Low.

Registers can be cascaded by connecting the last (Q) output of one stage to the SLI input of the next stage and connecting clock, (CE), and (CLR) in parallel.

This register is asynchronously cleared, outputs Low, when power is applied. For FPGA devices, power-on conditions are simulated when global set/reset (GSR) is active. GSR defaults to active-High but can be inverted by adding an inverter in front of the GSR input of the appropriate `STARTUP_architecture` symbol.

Logic Table

Inputs				Outputs	
CLR	CE	SLI	C	Q0	Qz : Q1
1	X	X	X	0	0
0	0	X	X	No Change	No Change
0	1	SLI	↑	SLI	qn-1

z = bit width - 1
qn-1 = state of referenced output one setup time prior to active clock transition

Design Entry Method

This design element is only for use in schematics.

For More Information

- See the [Spartan-3 Generation FPGA User Guide \(UG331\)](#).
- See the [Spartan-3E FPGA Family Data Sheet \(DS312\)](#).

SR16CLE

Macro: 16-Bit Loadable Serial/Parallel-In Parallel-Out Shift Register with Clock Enable and Asynchronous Clear

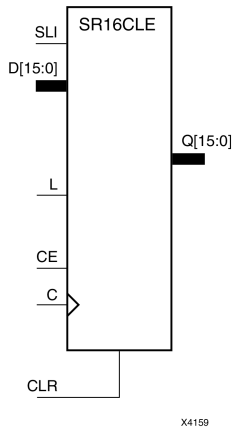

Introduction

This design element is a shift register with a shift-left serial input (SLI), parallel inputs (D), parallel outputs (Q), and three control inputs: clock enable (CE), load enable (L), and asynchronous clear (CLR). The register ignores clock transitions when (L) and (CE) are Low. The asynchronous (CLR), when High, overrides all other inputs and resets the data outputs (Q) Low. When (L) is High and (CLR) is Low, data on the Dn -D0 inputs is loaded into the corresponding Qn -(Q0) bits of the register.

When (CE) is High and (L) and (CLR) are Low, data on the SLI input is loaded into the first bit of the shift register during the Low-to-High clock (C) transition and appears on the (Q0) output. During subsequent clock transitions, when (CE) is High and (L) and (CLR) are Low, the data shifts to the next highest bit position as new data is loaded into (Q)0 (SLI into Q0, Q0 into Q1, Q1 into Q2, and so forth).

Registers can be cascaded by connecting the last (Q) output of one stage to the SLI input of the next stage and connecting clock, (CE), (L), and (CLR) inputs in parallel.

This register is asynchronously cleared, outputs Low, when power is applied. For FPGA devices, power-on conditions are simulated when global set/reset (GSR) is active. GSR defaults to active-High but can be inverted by adding an inverter in front of the GSR input of the appropriate STARTUP_architecture symbol.

Logic Table

Inputs						Outputs	
CLR	L	CE	SLI	Dn : D0	C	Q0	Qz : Q1
1	X	X	X	X	X	0	0
0	1	X	X	Dn : D0	↑	D0	Dn
0	0	1	SLI	X	↑	SLI	qn-1
0	0	0	X	X	X	No Change	No Change

z = bitwidth -1
qn-1 = state of referenced output one setup time prior to active clock transition

Design Entry Method

This design element is only for use in schematics.

For More Information

- See the [Spartan-3 Generation FPGA User Guide \(UG331\)](#).
- See the [Spartan-3E FPGA Family Data Sheet \(DS312\)](#).

SR16CLED

Macro: 16-Bit Shift Register with Clock Enable and Asynchronous Clear

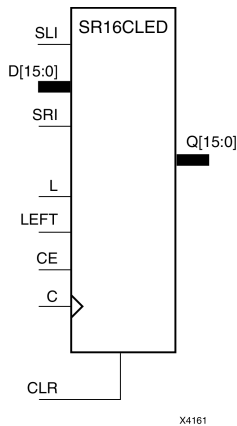

Introduction

This design element is a shift register with shift-left (SLI) and shift-right (SRI) serial inputs, parallel inputs (D), parallel outputs (Q), and four control inputs: clock enable (CE), load enable (L), shift left/right (LEFT), and asynchronous clear (CLR). The register ignores clock transitions when (CE) and (L) are Low. The asynchronous clear, when High, overrides all other inputs and resets the data outputs (Qn) Low.

When (L) is High and (CLR) is Low, the data on the (D) inputs is loaded into the corresponding (Q) bits of the register. When (CE) is High and (L) and (CLR) are Low, data is shifted right or left, depending on the state of the LEFT input. If LEFT is High, data on the SLI is loaded into (Q0) during the Low-to-High clock transition and shifted left (for example, to Q1 or Q2) during subsequent clock transitions. If LEFT is Low, data on the SRI is loaded into the last (Q) output during the Low-to-High clock transition and shifted right during subsequent clock transitions. The logic tables indicate the state of the (Q) outputs under all input conditions.

This register is asynchronously cleared, outputs Low, when power is applied. For FPGA devices, power-on conditions are simulated when global set/reset (GSR) is active. GSR defaults to active-High but can be inverted by adding an inverter in front of the GSR input of the appropriate STARTUP_architecture symbol.

Logic Table

Inputs								Outputs		
CLR	L	CE	LEFT	SLI	SRI	D15 : D0	C	Q0	Q15	Q14 : Q1
1	X	X	X	X	X	X	X	0	0	0
0	1	X	X	X	X	D15 : D0	↑	D0	D15	Dn
0	0	0	X	X	X	X	X	No Change	No Change	No Change
0	0	1	1	SLI	X	X	↑	SLI	q14	qn-1
0	0	1	0	X	SRI	X	↑	q1	SRI	qn+1

qn-1 or qn+1 = state of referenced output one setup time prior to active clock transition.

Design Entry Method

This design element is only for use in schematics.

For More Information

- See the [Spartan-3 Generation FPGA User Guide \(UG331\)](#).
- See the [Spartan-3E FPGA Family Data Sheet \(DS312\)](#).

SR16RE

Macro: 16-Bit Serial-In Parallel-Out Shift Register with Clock Enable and Synchronous Reset

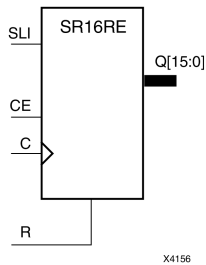

Introduction

This design element is a shift register with shift-left serial input (SLI), parallel outputs (Qn), clock enable (CE), and synchronous reset (R) inputs. The R input, when High, overrides all other inputs during the Low-to-High clock (C) transition and resets the data outputs (Q) Low.

When (CE) is High and (R) is Low, the data on the (SLI) is loaded into the first bit of the shift register during the Low-to-High clock (C) transition and appears on the (Q0) output. During subsequent Low-to-High clock transitions, when (CE) is High and R is Low, data shifts to the next highest bit position as new data is loaded into (Q0) (SLI into Q0, Q0 into Q1, Q1 into Q2, and so forth). The register ignores clock transitions when (CE) is Low.

Registers can be cascaded by connecting the last (Q) output of one stage to the SLI input of the next stage and connecting clock, (CE), and (R) in parallel.

This register is asynchronously cleared, outputs Low, when power is applied. For FPGA devices, power-on conditions are simulated when global set/reset (GSR) is active. GSR defaults to active-High but can be inverted by adding an inverter in front of the GSR input of the appropriate `STARTUP_architecture` symbol.

Logic Table

Inputs				Outputs	
R	CE	SLI	C	Q0	Qz : Q1
1	X	X	↑	0	0
0	0	X	X	No Change	No Change
0	1	SLI	↑	SLI	qn-1

z = bitwidth -1
qn-1 = state of referenced output one setup time prior to active clock transition

Design Entry Method

This design element is only for use in schematics.

For More Information

- See the [Spartan-3 Generation FPGA User Guide \(UG331\)](#).
- See the [Spartan-3E FPGA Family Data Sheet \(DS312\)](#).

SR16RLE

Macro: 16-Bit Loadable Serial/Parallel-In Parallel-Out Shift Register with Clock Enable and Synchronous Reset

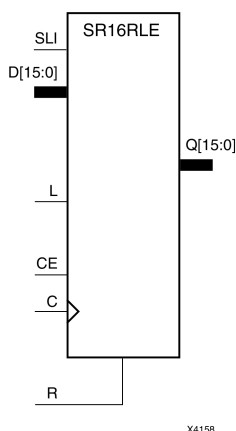

Introduction

This design element is a shift register with shift-left serial input (SLI), parallel inputs (D), parallel outputs (Q), and three control inputs: clock enable (CE), load enable (L), and synchronous reset (R). The register ignores clock transitions when (L) and (CE) are Low. The synchronous (R), when High, overrides all other inputs during the Low-to-High clock (C) transition and resets the data outputs (Q) Low. When (L) is High and (R) is Low during the Low-to-High clock transition, data on the (D) inputs is loaded into the corresponding Q bits of the register.

When (CE) is High and (L) and (R) are Low, data on the (SLI) input is loaded into the first bit of the shift register during the Low-to-High clock (C) transition and appears on the Q0 output. During subsequent clock transitions, when (CE) is High and (L) and (R) are Low, the data shifts to the next highest bit position as new data is loaded into Q0.

Registers can be cascaded by connecting the last Q output of one stage to the SLI input of the next stage and connecting clock, (CE), (L), and (R) inputs in parallel.

This register is asynchronously cleared, outputs Low, when power is applied. For FPGA devices, power-on conditions are simulated when global set/reset (GSR) is active. GSR defaults to active-High but can be inverted by adding an inverter in front of the GSR input of the appropriate `STARTUP_architecture` symbol.

Logic Table

Inputs						Outputs	
R	L	CE	SLI	Dz : D0	C	Q0	Qz : Q1
1	X	X	X	X	↑	0	0
0	1	X	X	Dz : D0	↑	D0	Dn
0	0	1	SLI	X	↑	SLI	qn-1
0	0	0	X	X	X	No Change	No Change

z = bitwidth -1
qn-1 = state of referenced output one setup time prior to active clock transition

Design Entry Method

This design element is only for use in schematics.

For More Information

- See the [Spartan-3 Generation FPGA User Guide \(UG331\)](#).
- See the [Spartan-3E FPGA Family Data Sheet \(DS312\)](#).

SR16RLED

Macro: 16-Bit Shift Register with Clock Enable and Synchronous Reset

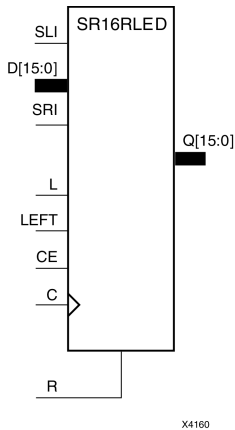

Introduction

This design element is a shift register with shift-left (SLI) and shift-right (SRI) serial inputs, parallel inputs (D), parallel outputs (Q) and four control inputs - clock enable (CE), load enable (L), shift left/right (LEFT), and synchronous reset (R). The register ignores clock transitions when (CE) and (L) are Low. The synchronous (R), when High, overrides all other inputs during the Low-to-High clock (C) transition and resets the data outputs (Q) Low. When (L) is High and (R) is Low during the Low-to-High clock transition, the data on the (D) inputs is loaded into the corresponding (Q) bits of the register.

When (CE) is High and (L) and (R) are Low, data shifts right or left, depending on the state of the LEFT input. If LEFT is High, data on (SLI) is loaded into (Q0) during the Low-to-High clock transition and shifted left (for example, to Q1 and Q2) during subsequent clock transitions. If LEFT is Low, data on the (SRI) is loaded into the last (Q) output during the Low-to-High clock transition and shifted right) during subsequent clock transitions. The logic tables below indicates the state of the (Q) outputs under all input conditions.

This register is asynchronously cleared, outputs Low, when power is applied. For FPGA devices, power-on conditions are simulated when global set/reset (GSR) is active. GSR defaults to active-High but can be inverted by adding an inverter in front of the GSR input of the appropriate STARTUP_architecture symbol.

Logic Table

Inputs								Outputs		
R	L	CE	LEFT	SLI	SRI	D15:D0	C	Q0	Q15	Q14:Q1
1	X	X	X	X	X	X	↑	0	0	0
0	1	X	X	X	X	D15:D0	↓	D0	D15	Dn
0	0	0	X	X	X	X	X	No Change	No Change	No Change
0	0	1	1	SLI	X	X	↑	SLI	q14	qn-1
0	0	1	0	X	SRI	X	↓	q1	SRI	qn+1

qn-1 or qn+1 = state of referenced output one setup time prior to active clock transition

Design Entry Method

This design element is only for use in schematics.

For More Information

- See the [Spartan-3 Generation FPGA User Guide \(UG331\)](#).
- See the [Spartan-3E FPGA Family Data Sheet \(DS312\)](#).

SR4CE

Macro: 4-Bit Serial-In Parallel-Out Shift Register with Clock Enable and Asynchronous Clear

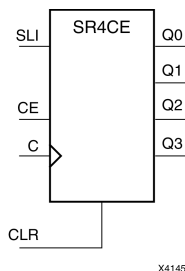

Introduction

This design element is a shift register with a shift-left serial input (SLI), parallel outputs (Q), and clock enable (CE) and asynchronous clear (CLR) inputs. The (CLR) input, when High, overrides all other inputs and resets the data outputs (Q) Low. When (CE) is High and (CLR) is Low, the data on the SLI input is loaded into the first bit of the shift register during the Low-to-High clock (C) transition and appears on the (Q0) output. During subsequent Low-to-High clock transitions, when (CE) is High and (CLR) is Low, data shifts to the next highest bit position as new data is loaded into (Q0) (SLI into Q0, Q0 into Q1, Q1 into Q2, and so forth). The register ignores clock transitions when (CE) is Low.

Registers can be cascaded by connecting the last (Q) output of one stage to the SLI input of the next stage and connecting clock, (CE), and (CLR) in parallel.

This register is asynchronously cleared, outputs Low, when power is applied. For FPGA devices, power-on conditions are simulated when global set/reset (GSR) is active. GSR defaults to active-High but can be inverted by adding an inverter in front of the GSR input of the appropriate `STARTUP_architecture` symbol.

Logic Table

Inputs				Outputs	
CLR	CE	SLI	C	Q0	Qz : Q1
1	X	X	X	0	0
0	0	X	X	No Change	No Change
0	1	SLI	↑	SLI	qn-1

z = bit width - 1
qn-1 = state of referenced output one setup time prior to active clock transition

Design Entry Method

This design element is only for use in schematics.

For More Information

- See the [Spartan-3 Generation FPGA User Guide \(UG331\)](#).
- See the [Spartan-3E FPGA Family Data Sheet \(DS312\)](#).

SR4CLE

Macro: 4-Bit Loadable Serial/Parallel-In Parallel-Out Shift Register with Clock Enable and Asynchronous Clear

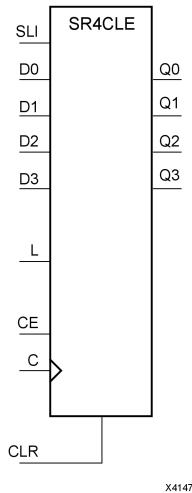

Introduction

This design element is a shift register with a shift-left serial input (SLI), parallel inputs (D), parallel outputs (Q), and three control inputs: clock enable (CE), load enable (L), and asynchronous clear (CLR). The register ignores clock transitions when (L) and (CE) are Low. The asynchronous (CLR), when High, overrides all other inputs and resets the data outputs (Q) Low. When (L) is High and (CLR) is Low, data on the Dn -D0 inputs is loaded into the corresponding Qn -(Q0) bits of the register.

When (CE) is High and (L) and (CLR) are Low, data on the SLI input is loaded into the first bit of the shift register during the Low-to-High clock (C) transition and appears on the (Q0) output. During subsequent clock transitions, when (CE) is High and (L) and (CLR) are Low, the data shifts to the next highest bit position as new data is loaded into (Q)0 (SLI into Q0, Q0 into Q1, Q1 into Q2, and so forth).

Registers can be cascaded by connecting the last (Q) output of one stage to the SLI input of the next stage and connecting clock, (CE), (L), and (CLR) inputs in parallel.

This register is asynchronously cleared, outputs Low, when power is applied. For FPGA devices, power-on conditions are simulated when global set/reset (GSR) is active. GSR defaults to active-High but can be inverted by adding an inverter in front of the GSR input of the appropriate STARTUP_architecture symbol.

Logic Table

Inputs						Outputs	
CLR	L	CE	SLI	Dn : D0	C	Q0	Qz : Q1
1	X	X	X	X	X	0	0
0	1	X	X	Dn : D0	↑	D0	Dn
0	0	1	SLI	X	↑	SLI	qn-1
0	0	0	X	X	X	No Change	No Change

z = bitwidth -1
qn-1 = state of referenced output one setup time prior to active clock transition

Design Entry Method

This design element is only for use in schematics.

For More Information

- See the [Spartan-3 Generation FPGA User Guide \(UG331\)](#).
- See the [Spartan-3E FPGA Family Data Sheet \(DS312\)](#).

SR4CLED

Macro: 4-Bit Shift Register with Clock Enable and Asynchronous Clear

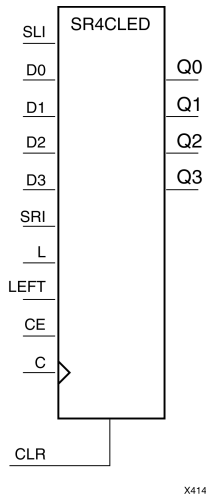

Introduction

This design element is a shift register with shift-left (SLI) and shift-right (SRI) serial inputs, parallel inputs (D), parallel outputs (Q), and four control inputs: clock enable (CE), load enable (L), shift left/right (LEFT), and asynchronous clear (CLR). The register ignores clock transitions when (CE) and (L) are Low. The asynchronous clear, when High, overrides all other inputs and resets the data outputs (Qn) Low.

When (L) is High and (CLR) is Low, the data on the (D) inputs is loaded into the corresponding (Q) bits of the register. When (CE) is High and (L) and (CLR) are Low, data is shifted right or left, depending on the state of the LEFT input. If LEFT is High, data on the SLI is loaded into (Q0) during the Low-to-High clock transition and shifted left (for example, to Q1 or Q2) during subsequent clock transitions. If LEFT is Low, data on the SRI is loaded into the last (Q) output during the Low-to-High clock transition and shifted right during subsequent clock transitions. The logic tables indicate the state of the (Q) outputs under all input conditions.

This register is asynchronously cleared, outputs Low, when power is applied. For FPGA devices, power-on conditions are simulated when global set/reset (GSR) is active. GSR defaults to active-High but can be inverted by adding an inverter in front of the GSR input of the appropriate STARTUP_architecture symbol.

Logic Table

Inputs								Outputs		
CLR	L	CE	LEFT	SLI	SRI	D3 : D0	C	Q0	Q3	Q2 : Q1
1	X	X	X	X	X	X	X	0	0	0
0	1	X	X	X	X	D3– D0	↑	D0	D3	Dn
0	0	0	X	X	X	X	X	No Change	No Change	No Change
0	0	1	1	SLI	X	X	↑	SLI	q2	qn-1
0	0	1	0	X	SRI	X	↑	q1	SRI	qn+1

qn-1 and qn+1 = state of referenced output one setup time prior to active clock transition.

Design Entry Method

This design element is only for use in schematics.

For More Information

- See the [Spartan-3 Generation FPGA User Guide \(UG331\)](#).
- See the [Spartan-3E FPGA Family Data Sheet \(DS312\)](#).

SR4RE

Macro: 4-Bit Serial-In Parallel-Out Shift Register with Clock Enable and Synchronous Reset

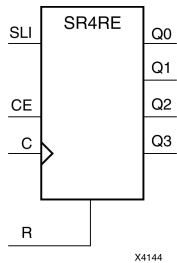

Introduction

This design element is a shift register with shift-left serial input (SLI), parallel outputs (Qn), clock enable (CE), and synchronous reset (R) inputs. The R input, when High, overrides all other inputs during the Low-to-High clock (C) transition and resets the data outputs (Q) Low.

When (CE) is High and (R) is Low, the data on the (SLI) is loaded into the first bit of the shift register during the Low-to-High clock (C) transition and appears on the (Q0) output. During subsequent Low-to-High clock transitions, when (CE) is High and R is Low, data shifts to the next highest bit position as new data is loaded into (Q0) (SLI into Q0, Q0 into Q1, Q1 into Q2, and so forth). The register ignores clock transitions when (CE) is Low.

Registers can be cascaded by connecting the last (Q) output of one stage to the SLI input of the next stage and connecting clock, (CE), and (R) in parallel.

This register is asynchronously cleared, outputs Low, when power is applied. For FPGA devices, power-on conditions are simulated when global set/reset (GSR) is active. GSR defaults to active-High but can be inverted by adding an inverter in front of the GSR input of the appropriate *STARTUP_architecture* symbol.

Logic Table

Inputs				Outputs	
R	CE	SLI	C	Q0	Qz : Q1
1	X	X	↑	0	0
0	0	X	X	No Change	No Change
0	1	SLI	↑	SLI	qn-1

z = bitwidth -1
qn-1 = state of referenced output one setup time prior to active clock transition

Design Entry Method

This design element is only for use in schematics.

For More Information

- See the [Spartan-3 Generation FPGA User Guide \(UG331\)](#).
- See the [Spartan-3E FPGA Family Data Sheet \(DS312\)](#).

SR4RLE

Macro: 4-Bit Loadable Serial/Parallel-In Parallel-Out Shift Register with Clock Enable and Synchronous Reset

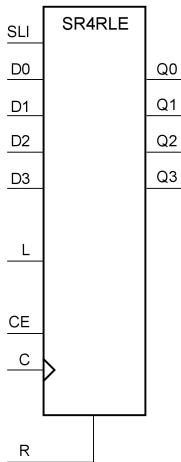

X4146

Introduction

This design element is a shift register with shift-left serial input (SLI), parallel inputs (D), parallel outputs (Q), and three control inputs: clock enable (CE), load enable (L), and synchronous reset (R). The register ignores clock transitions when (L) and (CE) are Low. The synchronous (R), when High, overrides all other inputs during the Low-to-High clock (C) transition and resets the data outputs (Q) Low. When (L) is High and (R) is Low during the Low-to-High clock transition, data on the (D) inputs is loaded into the corresponding Q bits of the register.

When (CE) is High and (L) and (R) are Low, data on the (SLI) input is loaded into the first bit of the shift register during the Low-to-High clock (C) transition and appears on the Q0 output. During subsequent clock transitions, when (CE) is High and (L) and (R) are Low, the data shifts to the next highest bit position as new data is loaded into Q0.

Registers can be cascaded by connecting the last Q output of one stage to the SLI input of the next stage and connecting clock, (CE), (L), and (R) inputs in parallel.

This register is asynchronously cleared, outputs Low, when power is applied. For FPGA devices, power-on conditions are simulated when global set/reset (GSR) is active. GSR defaults to active-High but can be inverted by adding an inverter in front of the GSR input of the appropriate *STARTUP_architecture* symbol.

Logic Table

Inputs						Outputs	
R	L	CE	SLI	Dz : D0	C	Q0	Qz : Q1
1	X	X	X	X	↑	0	0
0	1	X	X	Dz : D0	↑	D0	Dn
0	0	1	SLI	X	↑	SLI	qn-1
0	0	0	X	X	X	No Change	No Change

z = bitwidth -1
qn-1 = state of referenced output one setup time prior to active clock transition

Design Entry Method

This design element is only for use in schematics.

For More Information

- See the [Spartan-3 Generation FPGA User Guide \(UG331\)](#).
- See the [Spartan-3E FPGA Family Data Sheet \(DS312\)](#).

SR4RLED

Macro: 4-Bit Shift Register with Clock Enable and Synchronous Reset

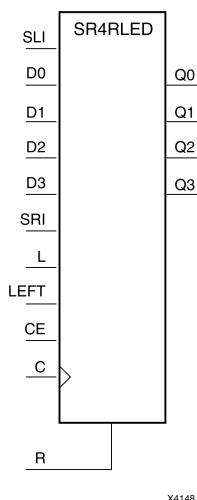

Introduction

This design element is a shift register with shift-left (SLI) and shift-right (SRI) serial inputs, parallel inputs (D), parallel outputs (Q) and four control inputs - clock enable (CE), load enable (L), shift left/right (LEFT), and synchronous reset (R). The register ignores clock transitions when (CE) and (L) are Low. The synchronous (R), when High, overrides all other inputs during the Low-to-High clock (C) transition and resets the data outputs (Q) Low. When (L) is High and (R) is Low during the Low-to-High clock transition, the data on the (D) inputs is loaded into the corresponding (Q) bits of the register.

When (CE) is High and (L) and (R) are Low, data shifts right or left, depending on the state of the LEFT input. If LEFT is High, data on (SLI) is loaded into (Q0) during the Low-to-High clock transition and shifted left (for example, to Q1 and Q2) during subsequent clock transitions. If LEFT is Low, data on the (SRI) is loaded into the last (Q) output during the Low-to-High clock transition and shifted right) during subsequent clock transitions. The logic tables below indicates the state of the (Q) outputs under all input conditions.

This register is asynchronously cleared, outputs Low, when power is applied. For FPGA devices, power-on conditions are simulated when global set/reset (GSR) is active. GSR defaults to active-High but can be inverted by adding an inverter in front of the GSR input of the appropriate STARTUP_architecture symbol.

Logic Table

Inputs								Outputs		
R	L	CE	LEFT	SLI	SRI	D3 : D0	C	Q0	Q3	Q2 : Q1
1	X	X	X	X	X	X	↑	0	0	0
0	1	X	X	X	X	D3 : D0	↑	D0	D3	Dn
0	0	0	X	X	X	X	X	No Change	No Change	No Change
0	0	1	1	SLI	X	X	↑	SLI	q2	qn-1
0	0	1	0	X	SRI	X	↑	q1	SRI	qn+1

qn-1 or qn+1 = state of referenced output one setup time prior to active clock transition

Design Entry Method

This design element is only for use in schematics.

For More Information

- See the [Spartan-3 Generation FPGA User Guide \(UG331\)](#).
- See the [Spartan-3E FPGA Family Data Sheet \(DS312\)](#).

SR8CE

Macro: 8-Bit Serial-In Parallel-Out Shift Register with Clock Enable and Asynchronous Clear

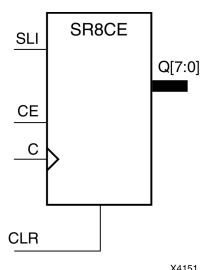

Introduction

This design element is a shift register with a shift-left serial input (SLI), parallel outputs (Q), and clock enable (CE) and asynchronous clear (CLR) inputs. The (CLR) input, when High, overrides all other inputs and resets the data outputs (Q) Low. When (CE) is High and (CLR) is Low, the data on the SLI input is loaded into the first bit of the shift register during the Low-to-High clock (C) transition and appears on the (Q0) output. During subsequent Low-to-High clock transitions, when (CE) is High and (CLR) is Low, data shifts to the next highest bit position as new data is loaded into (Q0) (SLI into Q0, Q0 into Q1, Q1 into Q2, and so forth). The register ignores clock transitions when (CE) is Low.

Registers can be cascaded by connecting the last (Q) output of one stage to the SLI input of the next stage and connecting clock, (CE), and (CLR) in parallel.

This register is asynchronously cleared, outputs Low, when power is applied. For FPGA devices, power-on conditions are simulated when global set/reset (GSR) is active. GSR defaults to active-High but can be inverted by adding an inverter in front of the GSR input of the appropriate `STARTUP_architecture` symbol.

Logic Table

Inputs				Outputs	
CLR	CE	SLI	C	Q0	Qz : Q1
1	X	X	X	0	0
0	0	X	X	No Change	No Change
0	1	SLI	↑	SLI	qn-1

z = bit width - 1
qn-1 = state of referenced output one setup time prior to active clock transition

Design Entry Method

This design element is only for use in schematics.

For More Information

- See the [Spartan-3 Generation FPGA User Guide \(UG331\)](#).
- See the [Spartan-3E FPGA Family Data Sheet \(DS312\)](#).

SR8CLE

Macro: 8-Bit Loadable Serial/Parallel-In Parallel-Out Shift Register with Clock Enable and Asynchronous Clear

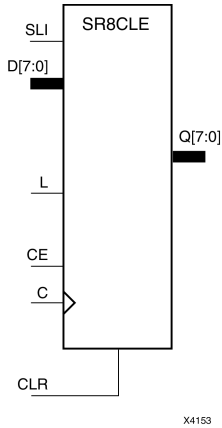

Introduction

This design element is a shift register with a shift-left serial input (SLI), parallel inputs (D), parallel outputs (Q), and three control inputs: clock enable (CE), load enable (L), and asynchronous clear (CLR). The register ignores clock transitions when (L) and (CE) are Low. The asynchronous (CLR), when High, overrides all other inputs and resets the data outputs (Q) Low. When (L) is High and (CLR) is Low, data on the Dn -D0 inputs is loaded into the corresponding Qn -(Q0) bits of the register.

When (CE) is High and (L) and (CLR) are Low, data on the SLI input is loaded into the first bit of the shift register during the Low-to-High clock (C) transition and appears on the (Q0) output. During subsequent clock transitions, when (CE) is High and (L) and (CLR) are Low, the data shifts to the next highest bit position as new data is loaded into (Q)0 (SLI into Q0, Q0 into Q1, Q1 into Q2, and so forth).

Registers can be cascaded by connecting the last (Q) output of one stage to the SLI input of the next stage and connecting clock, (CE), (L), and (CLR) inputs in parallel.

This register is asynchronously cleared, outputs Low, when power is applied. For FPGA devices, power-on conditions are simulated when global set/reset (GSR) is active. GSR defaults to active-High but can be inverted by adding an inverter in front of the GSR input of the appropriate STARTUP_architecture symbol.

Logic Table

Inputs						Outputs	
CLR	L	CE	SLI	Dn : D0	C	Q0	Qz : Q1
1	X	X	X	X	X	0	0
0	1	X	X	Dn : D0	↑	D0	Dn
0	0	1	SLI	X	↑	SLI	qn-1
0	0	0	X	X	X	No Change	No Change

z = bitwidth -1
qn-1 = state of referenced output one setup time prior to active clock transition

Design Entry Method

This design element is only for use in schematics.

For More Information

- See the [Spartan-3 Generation FPGA User Guide \(UG331\)](#).
- See the [Spartan-3E FPGA Family Data Sheet \(DS312\)](#).

SR8CLED

Macro: 8-Bit Shift Register with Clock Enable and Asynchronous Clear

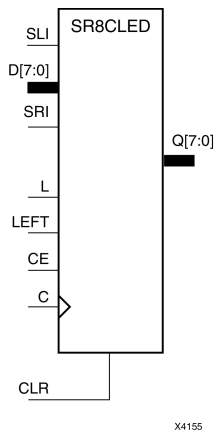

Introduction

This design element is a shift register with shift-left (SLI) and shift-right (SRI) serial inputs, parallel inputs (D), parallel outputs (Q), and four control inputs: clock enable (CE), load enable (L), shift left/right (LEFT), and asynchronous clear (CLR). The register ignores clock transitions when (CE) and (L) are Low. The asynchronous clear, when High, overrides all other inputs and resets the data outputs (Qn) Low.

When (L) is High and (CLR) is Low, the data on the (D) inputs is loaded into the corresponding (Q) bits of the register. When (CE) is High and (L) and (CLR) are Low, data is shifted right or left, depending on the state of the LEFT input. If LEFT is High, data on the SLI is loaded into (Q0) during the Low-to-High clock transition and shifted left (for example, to Q1 or Q2) during subsequent clock transitions. If LEFT is Low, data on the SRI is loaded into the last (Q) output during the Low-to-High clock transition and shifted right during subsequent clock transitions. The logic tables indicate the state of the (Q) outputs under all input conditions.

This register is asynchronously cleared, outputs Low, when power is applied. For FPGA devices, power-on conditions are simulated when global set/reset (GSR) is active. GSR defaults to active-High but can be inverted by adding an inverter in front of the GSR input of the appropriate STARTUP_architecture symbol.

Logic Table

Inputs								Outputs		
CLR	L	CE	LEFT	SLI	SRI	D7 : D0	C	Q0	Q7	Q6 : Q1
1	X	X	X	X	X	X	X	0	0	0
0	1	X	X	X	X	D7 : D0	↑	D0	D7	Dn
0	0	0	X	X	X	X	X	No Change	No Change	No Change
0	0	1	1	SLI	X	X	↑	SLI	q6	qn-1
0	0	1	0	X	SRI	X	↑	q1	SRI	qn+1

qn-1 or qn+1 = state of referenced output one setup time prior to active clock transition.

Design Entry Method

This design element is only for use in schematics.

For More Information

- See the [Spartan-3 Generation FPGA User Guide \(UG331\)](#).
- See the [Spartan-3E FPGA Family Data Sheet \(DS312\)](#).

SR8RE

Macro: 8-Bit Serial-In Parallel-Out Shift Register with Clock Enable and Synchronous Reset

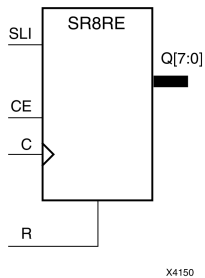

Introduction

This design element is a shift register with shift-left serial input (SLI), parallel outputs (Qn), clock enable (CE), and synchronous reset (R) inputs. The R input, when High, overrides all other inputs during the Low-to-High clock (C) transition and resets the data outputs (Q) Low.

When (CE) is High and (R) is Low, the data on the (SLI) is loaded into the first bit of the shift register during the Low-to-High clock (C) transition and appears on the (Q0) output. During subsequent Low-to-High clock transitions, when (CE) is High and R is Low, data shifts to the next highest bit position as new data is loaded into (Q0) (SLI into Q0, Q0 into Q1, Q1 into Q2, and so forth). The register ignores clock transitions when (CE) is Low.

Registers can be cascaded by connecting the last (Q) output of one stage to the SLI input of the next stage and connecting clock, (CE), and (R) in parallel.

This register is asynchronously cleared, outputs Low, when power is applied. For FPGA devices, power-on conditions are simulated when global set/reset (GSR) is active. GSR defaults to active-High but can be inverted by adding an inverter in front of the GSR input of the appropriate `STARTUP_architecture` symbol.

Logic Table

Inputs				Outputs	
R	CE	SLI	C	Q0	Qz : Q1
1	X	X	↑	0	0
0	0	X	X	No Change	No Change
0	1	SLI	↑	SLI	qn-1

z = bitwidth -1
qn-1 = state of referenced output one setup time prior to active clock transition

Design Entry Method

This design element is only for use in schematics.

For More Information

- See the [Spartan-3 Generation FPGA User Guide \(UG331\)](#).
- See the [Spartan-3E FPGA Family Data Sheet \(DS312\)](#).

SR8RLE

Macro: 8-Bit Loadable Serial/Parallel-In Parallel-Out Shift Register with Clock Enable and Synchronous Reset

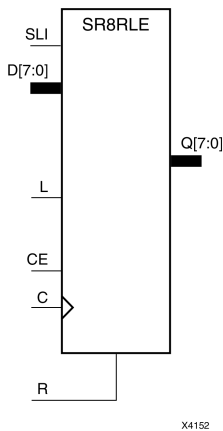

Introduction

This design element is a shift register with shift-left serial input (SLI), parallel inputs (D), parallel outputs (Q), and three control inputs: clock enable (CE), load enable (L), and synchronous reset (R). The register ignores clock transitions when (L) and (CE) are Low. The synchronous (R), when High, overrides all other inputs during the Low-to-High clock (C) transition and resets the data outputs (Q) Low. When (L) is High and (R) is Low during the Low-to-High clock transition, data on the (D) inputs is loaded into the corresponding Q bits of the register.

When (CE) is High and (L) and (R) are Low, data on the (SLI) input is loaded into the first bit of the shift register during the Low-to-High clock (C) transition and appears on the Q0 output. During subsequent clock transitions, when (CE) is High and (L) and (R) are Low, the data shifts to the next highest bit position as new data is loaded into Q0.

Registers can be cascaded by connecting the last Q output of one stage to the SLI input of the next stage and connecting clock, (CE), (L), and (R) inputs in parallel.

This register is asynchronously cleared, outputs Low, when power is applied. For FPGA devices, power-on conditions are simulated when global set/reset (GSR) is active. GSR defaults to active-High but can be inverted by adding an inverter in front of the GSR input of the appropriate `STARTUP_architecture` symbol.

Logic Table

Inputs						Outputs	
R	L	CE	SLI	Dz : D0	C	Q0	Qz : Q1
1	X	X	X	X	↑	0	0
0	1	X	X	Dz : D0	↑	D0	Dn
0	0	1	SLI	X	↑	SLI	qn-1
0	0	0	X	X	X	No Change	No Change

z = bitwidth -1
qn-1 = state of referenced output one setup time prior to active clock transition

Design Entry Method

This design element is only for use in schematics.

For More Information

- See the [Spartan-3 Generation FPGA User Guide \(UG331\)](#).
- See the [Spartan-3E FPGA Family Data Sheet \(DS312\)](#).

SR8RLED

Macro: 8-Bit Shift Register with Clock Enable and Synchronous Reset

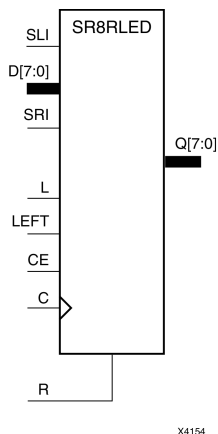

Introduction

This design element is a shift register with shift-left (SLI) and shift-right (SRI) serial inputs, parallel inputs (D), parallel outputs (Q) and four control inputs - clock enable (CE), load enable (L), shift left/right (LEFT), and synchronous reset (R). The register ignores clock transitions when (CE) and (L) are Low. The synchronous (R), when High, overrides all other inputs during the Low-to-High clock (C) transition and resets the data outputs (Q) Low. When (L) is High and (R) is Low during the Low-to-High clock transition, the data on the (D) inputs is loaded into the corresponding (Q) bits of the register.

When (CE) is High and (L) and (R) are Low, data shifts right or left, depending on the state of the LEFT input. If LEFT is High, data on (SLI) is loaded into (Q0) during the Low-to-High clock transition and shifted left (for example, to Q1 and Q2) during subsequent clock transitions. If LEFT is Low, data on the (SRI) is loaded into the last (Q) output during the Low-to-High clock transition and shifted right) during subsequent clock transitions. The logic tables below indicates the state of the (Q) outputs under all input conditions.

This register is asynchronously cleared, outputs Low, when power is applied. For FPGA devices, power-on conditions are simulated when global set/reset (GSR) is active. GSR defaults to active-High but can be inverted by adding an inverter in front of the GSR input of the appropriate *STARTUP_architecture* symbol.

Logic Table

Inputs								Outputs		
R	L	CE	LEFT	SLI	SRI	D7 : D0	C	Q0	Q7	Q6 : Q1
1	X	X	X	X	X	X	↑	0	0	0
0	1	X	X	X	X	D7 : D0	↓	D0	D7	Dn
0	0	0	X	X	X	X	X	No Change	No Change	No Change
0	0	1	1	SLI	X	X	↑	SLI	q6	qn-1
0	0	1	0	X	SRI	X	↓	q1	SRI	qn+1

qn-1 or qn+1 = state of referenced output one setup time prior to active clock transition

Design Entry Method

This design element is only for use in schematics.

For More Information

- See the [Spartan-3 Generation FPGA User Guide \(UG331\)](#).
- See the [Spartan-3E FPGA Family Data Sheet \(DS312\)](#).

SRL16

Primitive: 16-Bit Shift Register Look-Up Table (LUT)

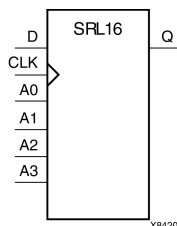

Introduction

This design element is a shift register look-up table (LUT). The inputs A3, A2, A1, and A0 select the output length of the shift register.

The shift register can be of a fixed, static length or it can be dynamically adjusted.

- **To create a fixed-length shift register** - Drive the A3 through A0 inputs with static values. The length of the shift register can vary from 1 bit to 16 bits, as determined by the following formula: Length = $(8 \times A3) + (4 \times A2) + (2 \times A1) + A0 + 1$. If A3, A2, A1, and A0 are all zeros (0000), the shift register is one bit long. If they are all ones (1111), it is 16 bits long.
- **To change the length of the shift register dynamically** - Change the values driving the A3 through A0 inputs. For example, if A2, A1, and A0 are all ones (111) and A3 toggles between a one (1) and a zero (0), the length of the shift register changes from 16 bits to 8 bits. Internally, the length of the shift register is always 16 bits and the input lines A3 through A0 select which of the 16 bits reach the output.

The shift register LUT contents are initialized by assigning a four-digit hexadecimal number to an INIT attribute. The first, or the left-most, hexadecimal digit is the most significant bit. If an INIT value is not specified, it defaults to a value of four zeros (0000) so that the shift register LUT is cleared during configuration.

The data (D) is loaded into the first bit of the shift register during the Low-to-High clock (CLK) transition. During subsequent Low-to-High clock transitions data shifts to the next highest bit position while new data is loaded. The data appears on the Q output when the shift register length determined by the address inputs is reached.

Logic Table

Inputs			Output
A _m	CLK	D	Q
A _m	X	X	Q(A _m)
A _m	↑	D	Q(A _m - 1)
m = 0, 1, 2, 3			

Design Entry Method

This design element can be used in schematics.

Available Attributes

Attribute	Data Type	Allowed Values	Default	Description
INIT	Hexadecimal	Any 16-Bit Value	All zeros	Sets the initial value of Q output after configuration.

For More Information

- See the [Spartan-3 Generation FPGA User Guide \(UG331\)](#).
- See the [Spartan-3E FPGA Family Data Sheet \(DS312\)](#).

SRL16_1

Primitive: 16-Bit Shift Register Look-Up Table (LUT) with Negative-Edge Clock

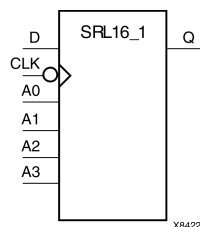

Introduction

This design element is a shift register look-up table (LUT). The inputs A3, A2, A1, and A0 select the output length of the shift register.

The shift register can be of a fixed, static length or it can be dynamically adjusted.

- **To create a fixed-length shift register** -Drive the A3 through A0 inputs with static values. The length of the shift register can vary from 1 bit to 16 bits, as determined by the following formula: $\text{Length} = (8 \times A3) + (4 \times A2) + (2 \times A1) + A0 + 1$. If A3, A2, A1, and A0 are all zeros (0000), the shift register is one bit long. If they are all ones (1111), it is 16 bits long.
- **To change the length of the shift register dynamically** -Change the values driving the A3 through A0 inputs. For example, if A2, A1, and A0 are all ones (111) and A3 toggles between a one (1) and a zero (0), the length of the shift register changes from 16 bits to 8 bits. Internally, the length of the shift register is always 16 bits and the input lines A3 through A0 select which of the 16 bits reach the output.

The shift register LUT contents are initialized by assigning a four-digit hexadecimal number to an INIT attribute. The first, or the left-most, hexadecimal digit is the most significant bit. If an INIT value is not specified, it defaults to a value of four zeros (0000) so that the shift register LUT is cleared during configuration.

The data (D) is loaded into the first bit of the shift register during the High-to-Low clock (CLK) transition. During subsequent High-to-Low clock transitions data shifts to the next highest bit position as new data is loaded. The data appears on the Q output when the shift register length determined by the address inputs is reached.

Logic Table

Inputs			Output
A _m	CLK	D	Q
A _m	X	X	Q(A _m)
A _m	↓	D	Q(A _m - 1)
m = 0, 1, 2, 3			

Design Entry Method

This design element can be used in schematics.

Available Attributes

Attribute	Data Type	Allowed Values	Default	Description
INIT	Hexadecimal	Any 16-Bit Value	All zeros	Sets the initial value of Q output after configuration

For More Information

- See the [Spartan-3 Generation FPGA User Guide \(UG331\)](#).
- See the [Spartan-3E FPGA Family Data Sheet \(DS312\)](#).

SRL16E

Primitive: 16-Bit Shift Register Look-Up Table (LUT) with Clock Enable

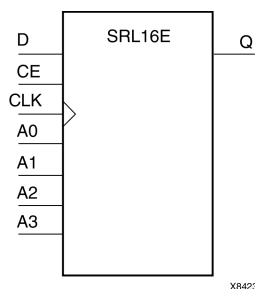

Introduction

This design element is a shift register look-up table (LUT). The inputs A3, A2, A1, and A0 select the output length of the shift register.

The shift register can be of a fixed, static length or it can be dynamically adjusted.

- **To create a fixed-length shift register** -Drive the A3 through A0 inputs with static values. The length of the shift register can vary from 1 bit to 16 bits, as determined by the following formula: Length = $(8 \times A3) + (4 \times A2) + (2 \times A1) + A0 + 1$. If A3, A2, A1, and A0 are all zeros (0000), the shift register is one bit long. If they are all ones (1111), it is 16 bits long.
- **To change the length of the shift register dynamically** -Change the values driving the A3 through A0 inputs. For example, if A2, A1, and A0 are all ones (111) and A3 toggles between a one (1) and a zero (0), the length of the shift register changes from 16 bits to 8 bits. Internally, the length of the shift register is always 16 bits and the input lines A3 through A0 select which of the 16 bits reach the output.

The shift register LUT contents are initialized by assigning a four-digit hexadecimal number to an INIT attribute. The first, or the left-most, hexadecimal digit is the most significant bit. If an INIT value is not specified, it defaults to a value of four zeros (0000) so that the shift register LUT is cleared during configuration.

When CE is High, the data (D) is loaded into the first bit of the shift register during the Low-to-High clock (CLK) transition. During subsequent Low-to-High clock transitions, when CE is High, data shifts to the next highest bit position as new data is loaded. The data appears on the Q output when the shift register length determined by the address inputs is reached. When CE is Low, the register ignores clock transitions.

Logic Table

Inputs				Output
A _m	CE	CLK	D	Q
A _m	0	X	X	Q(A _m)
A _m	1	↑	D	Q(A _m - 1)
m = 0, 1, 2, 3				

Port Descriptions

Port	Direction	Width	Function
Q	Output	1	Shift register data output
D	Input	1	Shift register data input
CLK	Input	1	Clock
CE	Input	1	Active high clock enable
A	Input	4	Dynamic depth selection of the SRL <ul style="list-style-type: none"> A=0000 ==> 1-bit shift length A=1111 ==> 16-bit shift length

Design Entry Method

This design element can be used in schematics.

Available Attributes

Attribute	Data Type	Allowed Values	Default	Description
INIT	Hexa-decimal	Any 16-Bit Value	All zeros	Sets the initial value of content and output of shift register after configuration.

For More Information

- See the [Spartan-3 Generation FPGA User Guide \(UG331\)](#).
- See the [Spartan-3E FPGA Family Data Sheet \(DS312\)](#).

SRL16E_1

Primitive: 16-Bit Shift Register Look-Up Table (LUT) with Negative-Edge Clock and Clock Enable

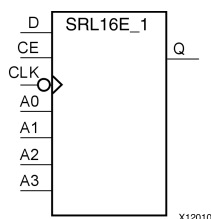

Introduction

This design element is a shift register look-up table (LUT) with clock enable (CE). The inputs A3, A2, A1, and A0 select the output length of the shift register.

The shift register can be of a fixed, static length or it can be dynamically adjusted.

- **To create a fixed-length shift register** -Drive the A3 through A0 inputs with static values. The length of the shift register can vary from 1 bit to 16 bits, as determined by the following formula: $\text{Length} = (8 \times A3) + (4 \times A2) + (2 \times A1) + A0 + 1$. If A3, A2, A1, and A0 are all zeros (0000), the shift register is one bit long. If they are all ones (1111), it is 16 bits long.
- **To change the length of the shift register dynamically** -Change the values driving the A3 through A0 inputs. For example, if A2, A1, and A0 are all ones (111) and A3 toggles between a one (1) and a zero (0), the length of the shift register changes from 16 bits to 8 bits. Internally, the length of the shift register is always 16 bits and the input lines A3 through A0 select which of the 16 bits reach the output.

The shift register LUT contents are initialized by assigning a four-digit hexadecimal number to an INIT attribute. The first, or the left-most, hexadecimal digit is the most significant bit. If an INIT value is not specified, it defaults to a value of four zeros (0000) so that the shift register LUT is cleared during configuration.

When CE is High, the data (D) is loaded into the first bit of the shift register during the High-to-Low clock (CLK) transition. During subsequent High-to-Low clock transitions, when CE is High, data is shifted to the next highest bit position as new data is loaded. The data appears on the Q output when the shift register length determined by the address inputs is reached. When CE is Low, the register ignores clock transitions.

Logic Table

Inputs				Output
A _m	CE	CLK	D	Q
A _m	0	X	X	Q(A _m)
A _m	1	↓	D	Q(A _m - 1)
m = 0, 1, 2, 3				

Design Entry Method

This design element can be used in schematics.

Available Attributes

Attribute	Type	Allowed Values	Default	Description
INIT	Hexadecimal	Any 16-Bit Value	All zeros	Sets the initial value of content and output of shift register after configuration.

For More Information

- See the [Spartan-3 Generation FPGA User Guide \(UG331\)](#).
- See the [Spartan-3E FPGA Family Data Sheet \(DS312\)](#).

SRLC16

Primitive: 16-Bit Shift Register Look-Up Table (LUT) with Carry

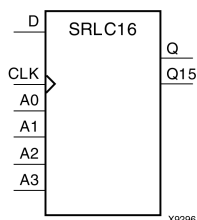

Introduction

This design element is a shift register look-up table (LUT) with Carry. The inputs A3, A2, A1, and A0 select the output length of the shift register.

The shift register can be of a fixed, static length or it can be dynamically adjusted.

- **To create a fixed-length shift register** -Drive the A3 through A0 inputs with static values. The length of the shift register can vary from 1 bit to 16 bits, as determined by the following formula: $\text{Length} = (8 \times A3) + (4 \times A2) + (2 \times A1) + A0 + 1$. If A3, A2, A1, and A0 are all zeros (0000), the shift register is one bit long. If they are all ones (1111), it is 16 bits long.
- **To change the length of the shift register dynamically** -Change the values driving the A3 through A0 inputs. For example, if A2, A1, and A0 are all ones (111) and A3 toggles between a one (1) and a zero (0), the length of the shift register changes from 16 bits to 8 bits. Internally, the length of the shift register is always 16 bits and the input lines A3 through A0 select which of the 16 bits reach the output.

The shift register LUT contents are initialized by assigning a four-digit hexadecimal number to an INIT attribute. The first, or the left-most, hexadecimal digit is the most significant bit. If an INIT value is not specified, it defaults to a value of four zeros (0000) so that the shift register LUT is cleared during configuration.

The data (D) is loaded into the first bit of the shift register during the Low-to-High clock (CLK) transition. During subsequent Low-to-High clock transitions data shifts to the next highest bit position as new data is loaded. The data appears on the Q output when the shift register length determined by the address inputs is reached.

Note The Q15 output is available for you in cascading to multiple shift register LUTs to create larger shift registers.

Logic Table

Inputs			Output
A _m	CLK	D	Q
A _m	X	X	Q(A _m)
A _m	↑	D	Q(A _m - 1)
m = 0, 1, 2, 3			

Design Entry Method

This design element can be used in schematics.

Available Attributes

Attribute	Data Type	Allowed Values	Default	Description
INIT	Hexadecimal	Any 16-Bit Value	All zeros	Sets the initial value of content and output of shift register after configuration.

For More Information

- See the [Spartan-3 Generation FPGA User Guide \(UG331\)](#).
- See the [Spartan-3E FPGA Family Data Sheet \(DS312\)](#).

SRLC16_1

Primitive: 16-Bit Shift Register Look-Up Table (LUT) with Carry and Negative-Edge Clock

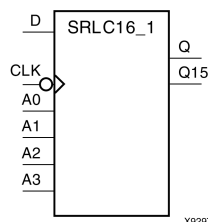

Introduction

This design element is a shift register look-up table (LUT) with carry and a negative-edge clock. The inputs A3, A2, A1, and A0 select the output length of the shift register.

The shift register can be of a fixed, static length or it can be dynamically adjusted.

- **To create a fixed-length shift register** -Drive the A3 through A0 inputs with static values. The length of the shift register can vary from 1 bit to 16 bits, as determined by the following formula: $\text{Length} = (8 \times A3) + (4 \times A2) + (2 \times A1) + A0 + 1$. If A3, A2, A1, and A0 are all zeros (0000), the shift register is one bit long. If they are all ones (1111), it is 16 bits long.
- **To change the length of the shift register dynamically** -Change the values driving the A3 through A0 inputs. For example, if A2, A1, and A0 are all ones (111) and A3 toggles between a one (1) and a zero (0), the length of the shift register changes from 16 bits to 8 bits. Internally, the length of the shift register is always 16 bits and the input lines A3 through A0 select which of the 16 bits reach the output.

The shift register LUT contents are initialized by assigning a four-digit hexadecimal number to an INIT attribute. The first, or the left-most, hexadecimal digit is the most significant bit. If an INIT value is not specified, it defaults to a value of four zeros (0000) so that the shift register LUT is cleared during configuration.

Note The Q15 output is available for your use in cascading multiple shift register LUTs to create larger shift registers.

Logic Table

Inputs			Output	
Am	CLK	D	Q	Q15
Am	X	X	Q(Am)	No Change
Am	↓	D	Q(Am - 1)	Q14
m= 0, 1, 2, 3				

Design Entry Method

This design element can be used in schematics.

Available Attributes

Attribute	Data Type	Allowed Values	Default	Description
INIT	Hexadecimal	Any 16-Bit Value	All zeros	Sets the initial value of content and output of shift register after configuration.

For More Information

- See the [Spartan-3 Generation FPGA User Guide \(UG331\)](#).
- See the [Spartan-3E FPGA Family Data Sheet \(DS312\)](#).

SRLC16E

Primitive: 16-Bit Shift Register Look-Up Table (LUT) with Carry and Clock Enable

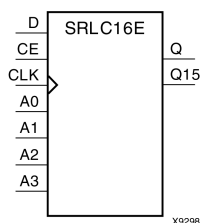

Introduction

This design element is a shift register look-up table (LUT) with carry and clock enable. The inputs A3, A2, A1, and A0 select the output length of the shift register.

The shift register can be of a fixed, static length or it can be dynamically adjusted.

- **To create a fixed-length shift register** -Drive the A3 through A0 inputs with static values. The length of the shift register can vary from 1 bit to 16 bits, as determined by the following formula: Length = $(8 \times A3) + (4 \times A2) + (2 \times A1) + A0 + 1$. If A3, A2, A1, and A0 are all zeros (0000), the shift register is one bit long. If they are all ones (1111), it is 16 bits long.
- **To change the length of the shift register dynamically** -Change the values driving the A3 through A0 inputs. For example, if A2, A1, and A0 are all ones (111) and A3 toggles between a one (1) and a zero (0), the length of the shift register changes from 16 bits to 8 bits. Internally, the length of the shift register is always 16 bits and the input lines A3 through A0 select which of the 16 bits reach the output.

The shift register LUT contents are initialized by assigning a four-digit hexadecimal number to an INIT attribute. The first, or the left-most, hexadecimal digit is the most significant bit. If an INIT value is not specified, it defaults to a value of four zeros (0000) so that the shift register LUT is cleared during configuration.

The data (D) is loaded into the first bit of the shift register during the Low-to-High clock (CLK) transition. When CE is High, during subsequent Low-to-High clock transitions, data shifts to the next highest bit position as new data is loaded. The data appears on the Q output when the shift register length determined by the address inputs is reached.

Note The Q15 output is available for you in cascading to multiple shift register LUTs to create larger shift registers.

Logic Table

Inputs				Output	
Am	CLK	CE	D	Q	Q15
Am	X	0	X	Q(Am)	Q(15)
Am	X	1	X	Q(Am)	Q(15)
Am	↑	1	D	Q(Am - 1)	Q15
m= 0, 1, 2, 3					

Design Entry Method

This design element can be used in schematics.

Available Attributes

Attribute	Data Type	Allowed Values	Default	Description
INIT	Hexadecimal	Any 16-Bit Value	All zeros	Sets the initial value of content and output of shift register after configuration.

For More Information

- See the [Spartan-3 Generation FPGA User Guide \(UG331\)](#).
- See the [Spartan-3E FPGA Family Data Sheet \(DS312\)](#).

SRLC16E_1

Primitive: 16-Bit Shift Register Look-Up Table (LUT) with Carry, Negative-Edge Clock, and Clock Enable

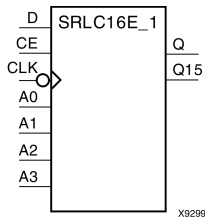

Introduction

This design element is a shift register look-up table (LUT) with carry, clock enable, and negative-edge clock. The inputs A3, A2, A1, and A0 select the output length of the shift register.

The shift register can be of a fixed, static length or it can be dynamically adjusted.

- **To create a fixed-length shift register** -Drive the A3 through A0 inputs with static values. The length of the shift register can vary from 1 bit to 16 bits, as determined by the following formula: Length = $(8 \times A3) + (4 \times A2) + (2 \times A1) + A0 + 1$. If A3, A2, A1, and A0 are all zeros (0000), the shift register is one bit long. If they are all ones (1111), it is 16 bits long.
- **To change the length of the shift register dynamically** -Change the values driving the A3 through A0 inputs. For example, if A2, A1, and A0 are all ones (111) and A3 toggles between a one (1) and a zero (0), the length of the shift register changes from 16 bits to 8 bits. Internally, the length of the shift register is always 16 bits and the input lines A3 through A0 select which of the 16 bits reach the output.

The shift register LUT contents are initialized by assigning a four-digit hexadecimal number to an INIT attribute. The first, or the left-most, hexadecimal digit is the most significant bit. If an INIT value is not specified, it defaults to a value of four zeros (0000) so that the shift register LUT is cleared during configuration.

When CE is High, the data (D) is loaded into the first bit of the shift register during the High-to-Low clock (CLK) transition. During subsequent High-to-Low clock transitions data shifts to the next highest bit position as new data is loaded when CE is High. The data appears on the Q output when the shift register length determined by the address inputs is reached.

Note The Q15 output is available for your use in cascading multiple shift register LUTs to create larger shift registers.

Logic Table

Inputs				Output	
A _m	CE	CLK	D	Q	Q15
A _m	0	X	X	Q(A _m)	No Change
A _m	1	X	X	Q(A _m)	No Change
A _m	1	↓	D	Q(A _m - 1)	Q14
m = 0, 1, 2, 3					

Design Entry Method

This design element can be used in schematics.

Available Attributes

Attribute	Data Type	Allowed Values	Default	Description
INIT	Hexadecimal	Any 16-Bit Value	All zeros	Sets the initial value of content and output of shift register after configuration.

For More Information

- See the [Spartan-3 Generation FPGA User Guide \(UG331\)](#).
- See the [Spartan-3E FPGA Family Data Sheet \(DS312\)](#).

STARTUP_SPARTAN3E

Primitive: Spartan®-3E User Interface to the GSR, GTS, Configuration Startup Sequence and Multi-Boot Trigger Circuitry

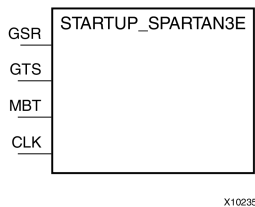

Introduction

This design element allows the connection of ports, or your circuitry, to control certain dedicated circuitry and routes within the FPGA. Signals connected the GSR port of this component can control the global set/reset (referred to as GSR) of the device. The GSR net connects to all registers in the device and places the registers into their initial value state. Connecting a signal to the GTS port connects to the dedicated route controlling the three-state outputs of every pin in the device. Connecting a clock signal to the CLK input allows the startup sequence after configuration to be synchronized to a user-defined clock. The MBT (Multi-Boot Trigger) pin allows the triggering of a new configuration when the device is properly set up for this feature.

Design Entry Method

This design element can be used in schematics.

For More Information

- See the [Spartan-3 Generation FPGA User Guide \(UG331\)](#).
- See the [Spartan-3E FPGA Family Data Sheet \(DS312\)](#).

VCC

Primitive: VCC-Connection Signal Tag



Introduction

This design element serves as a signal tag, or parameter, that forces a net or input function to a logic High level. A net tied to this element cannot have any other source.

When the placement and routing software encounters a net or input function tied to this element, it removes any logic that is disabled by the Vcc signal, which is only implemented when the disabled logic cannot be removed.

Design Entry Method

This design element is only for use in schematics.

For More Information

- See the [Spartan-3 Generation FPGA User Guide \(UG331\)](#).
- See the [Spartan-3E FPGA Family Data Sheet \(DS312\)](#).

XNOR2

Primitive: 2-Input XNOR Gate with Non-Inverted Inputs

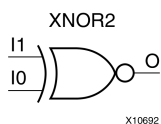

Introduction

XNOR elements implement Negated XOR. A High (1) output results if there are an even number of High (1) inputs. A Low (0) output results if there is an odd number of High (1) inputs.

XNOR functions of up to nine inputs are available. All inputs are non-inverting. Because each input uses a CLB resource, replace functions with unused inputs with functions having the necessary number of inputs.

Logic Table

Input	Output
I0 ... Iz	O
Odd number of 1	0
Even number of 1	1

Design Entry Method

This design element is only for use in schematics.

For More Information

- See the [Spartan-3 Generation FPGA User Guide \(UG331\)](#).
- See the [Spartan-3E FPGA Family Data Sheet \(DS312\)](#).

XNOR3

Primitive: 3-Input XNOR Gate with Non-Inverted Inputs

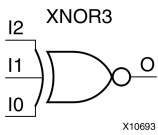

Introduction

XNOR elements implement Negated XOR. A High (1) output results if there are an even number of High (1) inputs. A Low (0) output results if there is an odd number of High (1) inputs.

XNOR functions of up to nine inputs are available. All inputs are non-inverting. Because each input uses a CLB resource, replace functions with unused inputs with functions having the necessary number of inputs.

Logic Table

Input	Output
I0 ... Iz	O
Odd number of 1	0
Even number of 1	1

Design Entry Method

This design element is only for use in schematics.

For More Information

- See the [Spartan-3 Generation FPGA User Guide \(UG331\)](#).
- See the [Spartan-3E FPGA Family Data Sheet \(DS312\)](#).

XNOR4

Primitive: 4-Input XNOR Gate with Non-Inverted Inputs

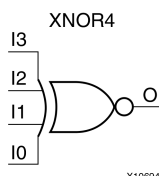

Introduction

XNOR elements implement Negated XOR. A High (1) output results if there are an even number of High (1) inputs. A Low (0) output results if there is an odd number of High (1) inputs.

XNOR functions of up to nine inputs are available. All inputs are non-inverting. Because each input uses a CLB resource, replace functions with unused inputs with functions having the necessary number of inputs.

Logic Table

Input	Output
I0 ... Iz	O
Odd number of 1	0
Even number of 1	1

Design Entry Method

This design element is only for use in schematics.

For More Information

- See the [Spartan-3 Generation FPGA User Guide \(UG331\)](#).
- See the [Spartan-3E FPGA Family Data Sheet \(DS312\)](#).

XNOR5

Primitive: 5-Input XNOR Gate with Non-Inverted Inputs

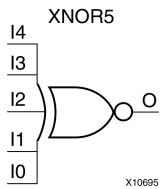

Introduction

XNOR elements implement Negated XOR. A High (1) output results if there are an even number of High (1) inputs. A Low (0) output results if there is an odd number of High (1) inputs.

XNOR functions of up to nine inputs are available. All inputs are non-inverting. Because each input uses a CLB resource, replace functions with unused inputs with functions having the necessary number of inputs.

Logic Table

Input	Output
I0 ... Iz	O
Odd number of 1	0
Even number of 1	1

Design Entry Method

This design element is only for use in schematics.

For More Information

- See the [Spartan-3 Generation FPGA User Guide \(UG331\)](#).
- See the [Spartan-3E FPGA Family Data Sheet \(DS312\)](#).

XNOR6

Macro: 6-Input XNOR Gate with Non-Inverted Inputs

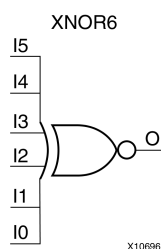

Introduction

XNOR elements implement Negated XOR. A High (1) output results if there are an even number of High (1) inputs. A Low (0) output results if there is an odd number of High (1) inputs.

XNOR functions of up to nine inputs are available. All inputs are non-inverting. Because each input uses a CLB resource, replace functions with unused inputs with functions having the necessary number of inputs.

Logic Table

Input	Output
I0 ... Iz	O
Odd number of 1	0
Even number of 1	1

Design Entry Method

This design element is only for use in schematics.

For More Information

- See the [Spartan-3 Generation FPGA User Guide \(UG331\)](#).
- See the [Spartan-3E FPGA Family Data Sheet \(DS312\)](#).

XNOR7

Macro: 7-Input XNOR Gate with Non-Inverted Inputs

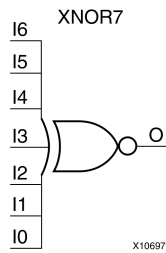

Introduction

XNOR elements implement Negated XOR. A High (1) output results if there are an even number of High (1) inputs. A Low (0) output results if there is an odd number of High (1) inputs.

XNOR functions of up to nine inputs are available. All inputs are non-inverting. Because each input uses a CLB resource, replace functions with unused inputs with functions having the necessary number of inputs.

Logic Table

Input	Output
I0 ... Iz	0
Odd number of 1	0
Even number of 1	1

Design Entry Method

This design element is only for use in schematics.

For More Information

- See the [Spartan-3 Generation FPGA User Guide \(UG331\)](#).
- See the [Spartan-3E FPGA Family Data Sheet \(DS312\)](#).

XNOR8

Macro: 8-Input XNOR Gate with Non-Inverted Inputs

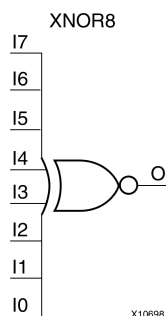

Introduction

XNOR elements implement Negated XOR. A High (1) output results if there are an even number of High (1) inputs. A Low (0) output results if there is an odd number of High (1) inputs.

XNOR functions of up to nine inputs are available. All inputs are non-inverting. Because each input uses a CLB resource, replace functions with unused inputs with functions having the necessary number of inputs.

Logic Table

Input	Output
I0 ... Iz	O
Odd number of 1	0
Even number of 1	1

Design Entry Method

This design element is only for use in schematics.

For More Information

- See the [Spartan-3 Generation FPGA User Guide \(UG331\)](#).
- See the [Spartan-3E FPGA Family Data Sheet \(DS312\)](#).

XNOR9

Macro: 9-Input XNOR Gate with Non-Inverted Inputs

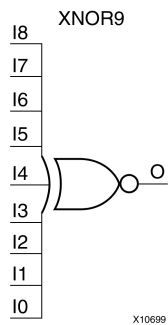

Introduction

XNOR elements implement Negated XOR. A High (1) output results if there are an even number of High (1) inputs. A Low (0) output results if there is an odd number of High (1) inputs.

XNOR functions of up to nine inputs are available. All inputs are non-inverting. Because each input uses a CLB resource, replace functions with unused inputs with functions having the necessary number of inputs.

Logic Table

Input	Output
I0 ... Iz	O
Odd number of 1	0
Even number of 1	1

Design Entry Method

This design element is only for use in schematics.

For More Information

- See the [Spartan-3 Generation FPGA User Guide \(UG331\)](#).
- See the [Spartan-3E FPGA Family Data Sheet \(DS312\)](#).

XOR2

Primitive: 2-Input XOR Gate with Non-Inverted Inputs

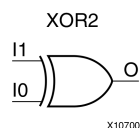

Introduction

XOR elements implement exclusive OR. A High (1) output results if there are an odd number of High (1) inputs. A Low (0) output results if there is an even number of High (1) inputs.

XOR functions of up to nine inputs are available. All inputs are non-inverting. Because each input uses a CLB resource, replace functions with unused inputs with functions having the necessary number of inputs.

Logic Table

Input	Output
I0 ... Iz	O
Odd number of 1	1
Even number of 1	0

Design Entry Method

This design element is only for use in schematics.

For More Information

- See the [Spartan-3 Generation FPGA User Guide \(UG331\)](#).
- See the [Spartan-3E FPGA Family Data Sheet \(DS312\)](#).

XOR3

Primitive: 3-Input XOR Gate with Non-Inverted Inputs

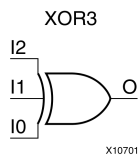

Introduction

XOR elements implement exclusive OR. A High (1) output results if there are an odd number of High (1) inputs. A Low (0) output results if there is an even number of High (1) inputs.

XOR functions of up to nine inputs are available. All inputs are non-inverting. Because each input uses a CLB resource, replace functions with unused inputs with functions having the necessary number of inputs.

Logic Table

Input	Output
I0 ... Iz	O
Odd number of 1	1
Even number of 1	0

Design Entry Method

This design element is only for use in schematics.

For More Information

- See the [Spartan-3 Generation FPGA User Guide \(UG331\)](#).
- See the [Spartan-3E FPGA Family Data Sheet \(DS312\)](#).

XOR4

Primitive: 4-Input XOR Gate with Non-Inverted Inputs

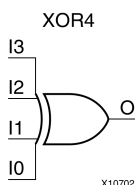

Introduction

XOR elements implement exclusive OR. A High (1) output results if there are an odd number of High (1) inputs. A Low (0) output results if there is an even number of High (1) inputs.

XOR functions of up to nine inputs are available. All inputs are non-inverting. Because each input uses a CLB resource, replace functions with unused inputs with functions having the necessary number of inputs.

Logic Table

Input	Output
I0 ... Iz	0
Odd number of 1	1
Even number of 1	0

Design Entry Method

This design element is only for use in schematics.

For More Information

- See the [Spartan-3 Generation FPGA User Guide \(UG331\)](#).
- See the [Spartan-3E FPGA Family Data Sheet \(DS312\)](#).

XOR5

Primitive: 5-Input XOR Gate with Non-Inverted Inputs

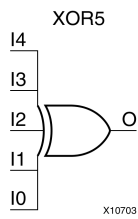

Introduction

XOR elements implement exclusive OR. A High (1) output results if there are an odd number of High (1) inputs. A Low (0) output results if there is an even number of High (1) inputs.

XOR functions of up to nine inputs are available. All inputs are non-inverting. Because each input uses a CLB resource, replace functions with unused inputs with functions having the necessary number of inputs.

Logic Table

Input	Output
I0 ... Iz	O
Odd number of 1	1
Even number of 1	0

Design Entry Method

This design element is only for use in schematics.

For More Information

- See the [Spartan-3 Generation FPGA User Guide \(UG331\)](#).
- See the [Spartan-3E FPGA Family Data Sheet \(DS312\)](#).

XOR6

Macro: 6-Input XOR Gate with Non-Inverted Inputs

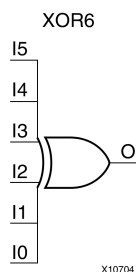

Introduction

XOR elements implement exclusive OR. A High (1) output results if there are an odd number of High (1) inputs. A Low (0) output results if there is an even number of High (1) inputs.

XOR functions of up to nine inputs are available. All inputs are non-inverting. Because each input uses a CLB resource, replace functions with unused inputs with functions having the necessary number of inputs.

Logic Table

Input	Output
I0 ... Iz	0
Odd number of 1	1
Even number of 1	0

Design Entry Method

This design element is only for use in schematics.

For More Information

- See the [Spartan-3 Generation FPGA User Guide \(UG331\)](#).
- See the [Spartan-3E FPGA Family Data Sheet \(DS312\)](#).

XOR7

Macro: 7-Input XOR Gate with Non-Inverted Inputs

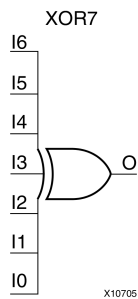

Introduction

XOR elements implement exclusive OR. A High (1) output results if there are an odd number of High (1) inputs. A Low (0) output results if there is an even number of High (1) inputs.

XOR functions of up to nine inputs are available. All inputs are non-inverting. Because each input uses a CLB resource, replace functions with unused inputs with functions having the necessary number of inputs.

Logic Table

Input	Output
I0 ... Iz	O
Odd number of 1	1
Even number of 1	0

Design Entry Method

This design element is only for use in schematics.

For More Information

- See the [Spartan-3 Generation FPGA User Guide \(UG331\)](#).
- See the [Spartan-3E FPGA Family Data Sheet \(DS312\)](#).

XOR8

Macro: 8-Input XOR Gate with Non-Inverted Inputs

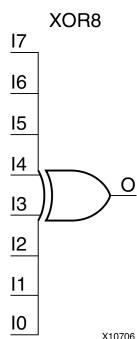

Introduction

XOR elements implement exclusive OR. A High (1) output results if there are an odd number of High (1) inputs. A Low (0) output results if there is an even number of High (1) inputs.

XOR functions of up to nine inputs are available. All inputs are non-inverting. Because each input uses a CLB resource, replace functions with unused inputs with functions having the necessary number of inputs.

Logic Table

Input	Output
I0 ... Iz	O
Odd number of 1	1
Even number of 1	0

Design Entry Method

This design element is only for use in schematics.

For More Information

- See the [Spartan-3 Generation FPGA User Guide \(UG331\)](#).
- See the [Spartan-3E FPGA Family Data Sheet \(DS312\)](#).

XOR9

Macro: 9-Input XOR Gate with Non-Inverted Inputs

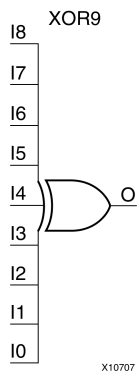

Introduction

XOR elements implement exclusive OR. A High (1) output results if there are an odd number of High (1) inputs. A Low (0) output results if there is an even number of High (1) inputs.

XOR functions of up to nine inputs are available. All inputs are non-inverting. Because each input uses a CLB resource, replace functions with unused inputs with functions having the necessary number of inputs.

Logic Table

Input	Output
I0 ... Iz	O
Odd number of 1	1
Even number of 1	0

Design Entry Method

This design element is only for use in schematics.

For More Information

- See the [Spartan-3 Generation FPGA User Guide \(UG331\)](#).
- See the [Spartan-3E FPGA Family Data Sheet \(DS312\)](#).

XORCY

Primitive: XOR for Carry Logic with General Output

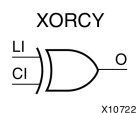

Introduction

This design element is a special XOR with general O output that generates faster and smaller arithmetic functions. The XORCY primitive is a dedicated XOR function within the carry-chain logic of the slice. It allows for fast and efficient creation of arithmetic (add/subtract) or wide logic functions (large AND/OR gate).

Logic Table

Input		Output
LI	CI	O
0	0	0
0	1	1
1	0	1
1	1	0

Design Entry Method

This design element can be used in schematics.

For More Information

- See the [Spartan-3 Generation FPGA User Guide \(UG331\)](#).
- See the [Spartan-3E FPGA Family Data Sheet \(DS312\)](#).

XORCY_D

Primitive: XOR for Carry Logic with Dual Output

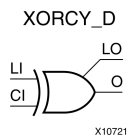

Introduction

This design element is a special XOR that generates faster and smaller arithmetic functions.

Logic Table

Input		Output
LI	CI	O and LO
0	0	0
0	1	1
1	0	1
1	1	0

Design Entry Method

This design element can be used in schematics.

For More Information

- See the [Spartan-3 Generation FPGA User Guide \(UG331\)](#).
- See the [Spartan-3E FPGA Family Data Sheet \(DS312\)](#).

XORCY_L

Primitive: XOR for Carry Logic with Local Output

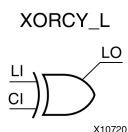

Introduction

This design element is a special XOR with local LO output that generates faster and smaller arithmetic functions.

Logic Table

Input		Output
LI	CI	LO
0	0	0
0	1	1
1	0	1
1	1	0

Design Entry Method

This design element can be used in schematics.

For More Information

- See the [Spartan-3 Generation FPGA User Guide \(UG331\)](#).
- See the [Spartan-3E FPGA Family Data Sheet \(DS312\)](#).