

ENGR-435 Digital Design II

Lecture 1: Introduction IC Technology

Introduction

- Integrated circuits: many transistors on one chip.
- *Very Large Scale Integration (VLSI)*: bucketloads!
- *Complementary Metal Oxide Semiconductor*
 - Fast, cheap, low power transistors
- Today: How to build your own simple CMOS chip
 - CMOS transistors
 - Building logic gates from transistors
 - Transistor layout and fabrication

Silicon Lattice

- Silicon is a Group IV material
- Forms crystal lattice with bonds to four neighbors
- Transistors are built on a silicon substrate

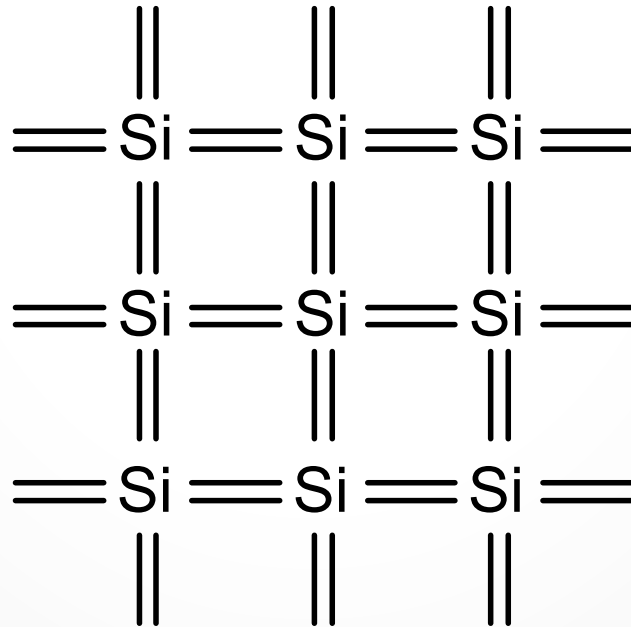

Dopants

- Silicon is a semiconductor
- Pure silicon has no free carriers and conducts poorly

Adding dopants increases the conductivity

- Group V: extra electron (n-type)
- Group III: missing electron, called hole (p-type)

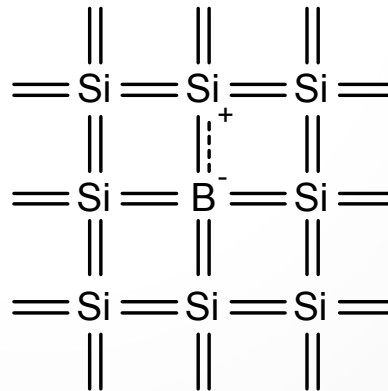
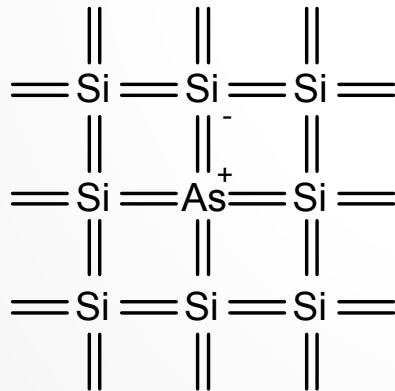

p-n Junctions

- A junction between p-type and n-type semiconductor forms a diode.
- Current flows only in one direction

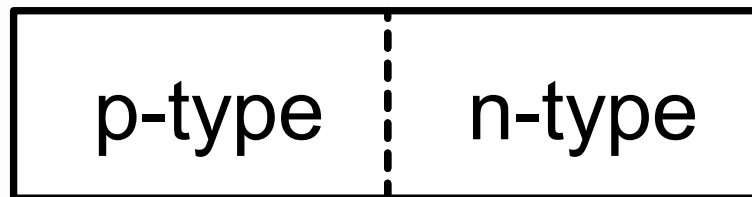

anode

cathode

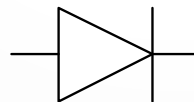

nMOS Transistor

- Four terminals: gate, source, drain, body
- Gate – oxide – body stack looks like a capacitor
 - Gate and body are conductors
 - SiO_2 (oxide) is a very good insulator
 - Called metal – oxide – semiconductor (MOS) capacitor
 - Even though gate is no longer made of metal

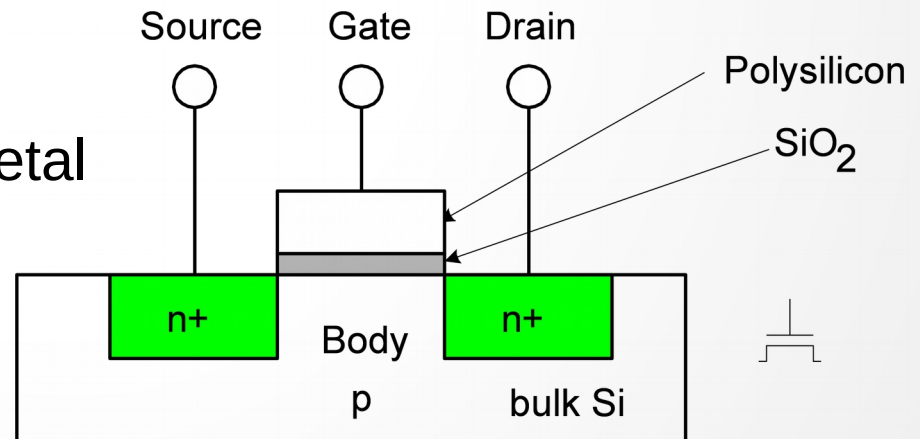

nMOS Operation

- Body is usually tied to ground (0 V)
- When the gate is at a low voltage:
 - P-type body is at low voltage
 - Source-body and drain-body diodes are OFF
 - No current flows, transistor is OFF

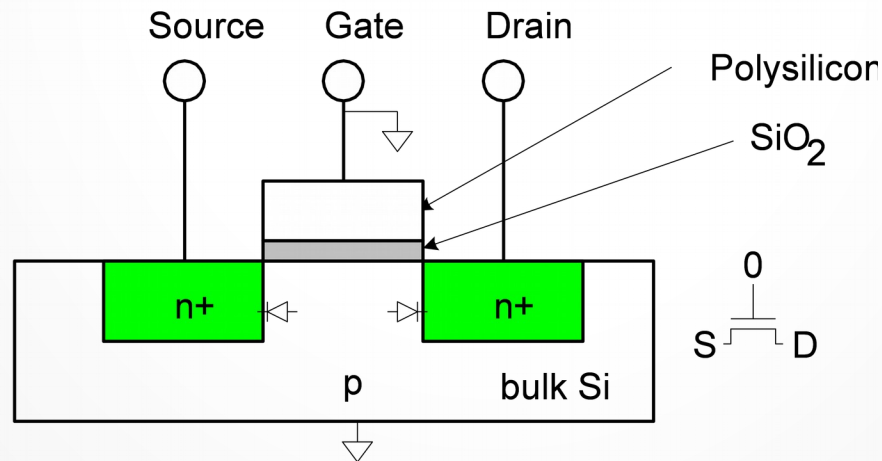

nMOS Operation Cont.

- When the gate is at a high voltage:
 - Positive charge on gate of MOS capacitor
 - Negative charge attracted to body
 - Inverts a channel under gate to n-type
 - Now current can flow through n-type silicon from source through channel to drain, transistor is ON

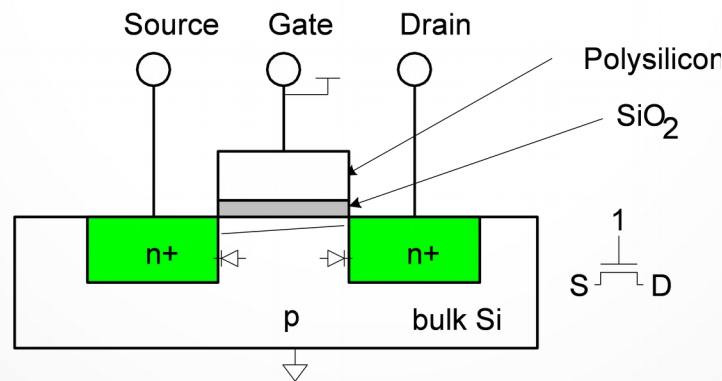

pMOS Transistor

- Similar, but doping and voltages reversed
 - Body tied to high voltage (V_{DD})
 - Gate low: transistor ON
 - Gate high: transistor OFF
 - Bubble indicates inverted behavior

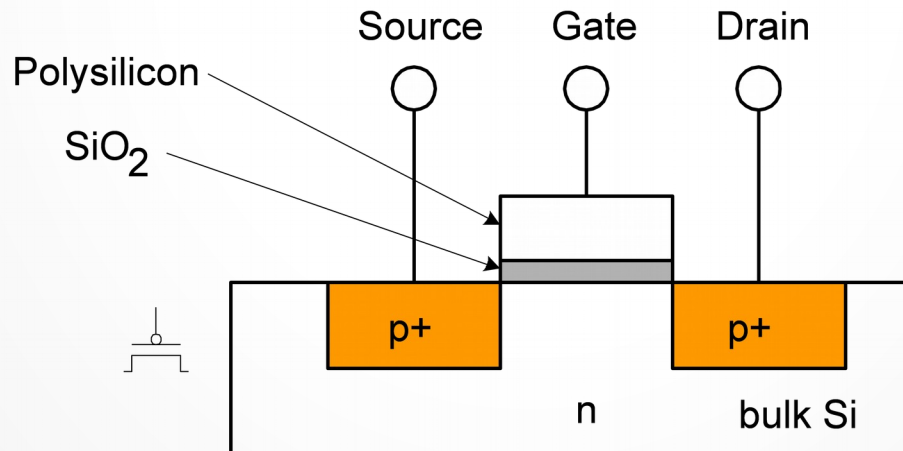

Power Supply Voltage

- $GND = 0\text{ V}$
- In 1980's, $V_{DD} = 5\text{V}$
- V_{DD} has decreased in modern processes
 - High V_{DD} would damage modern tiny transistors
 - Lower V_{DD} saves power
- $V_{DD} = 3.3, 2.5, 1.8, 1.5, 1.2, 1.0, \dots$

Transistors as Switches

- We can view MOS transistors as electrically controlled switches
- Voltage at gate controls path from source to drain

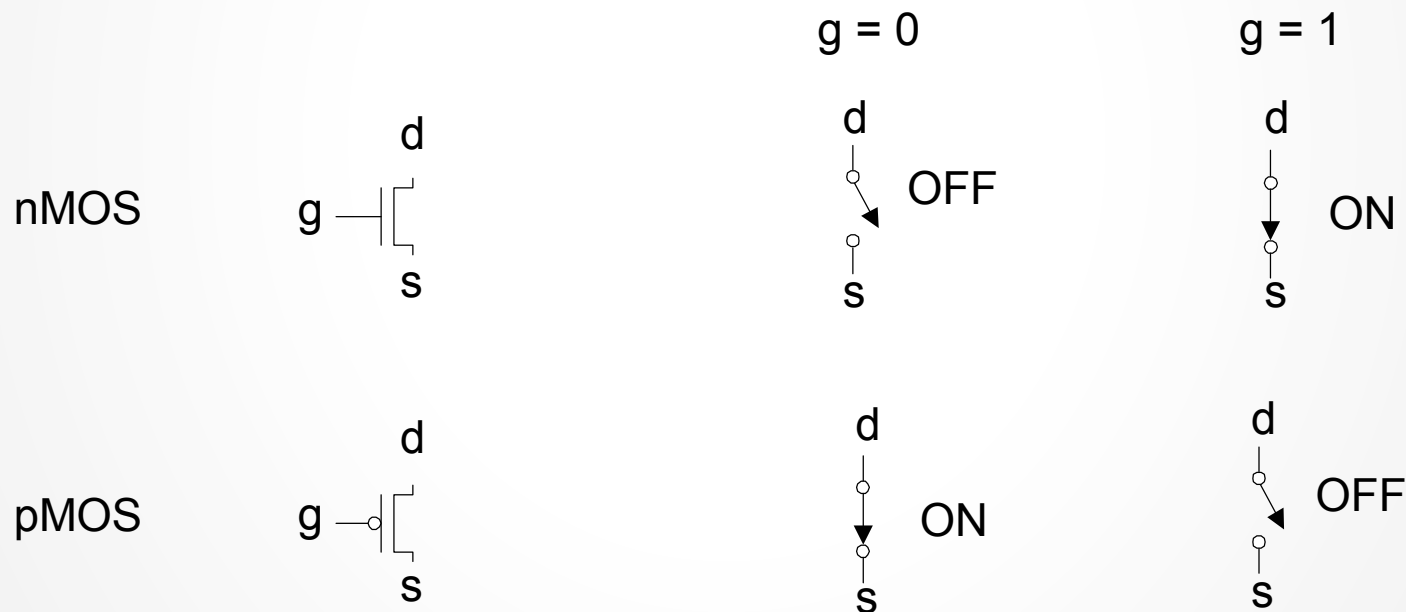

CMOS Inverter

A	Y

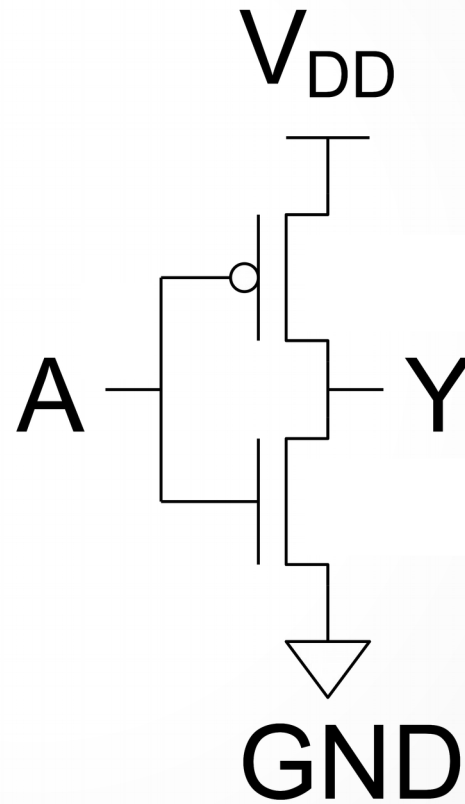
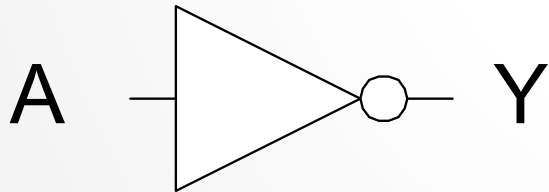

CMOS NAND Gate

A	B	Y
0	0	
0	1	
1	0	
1	1	

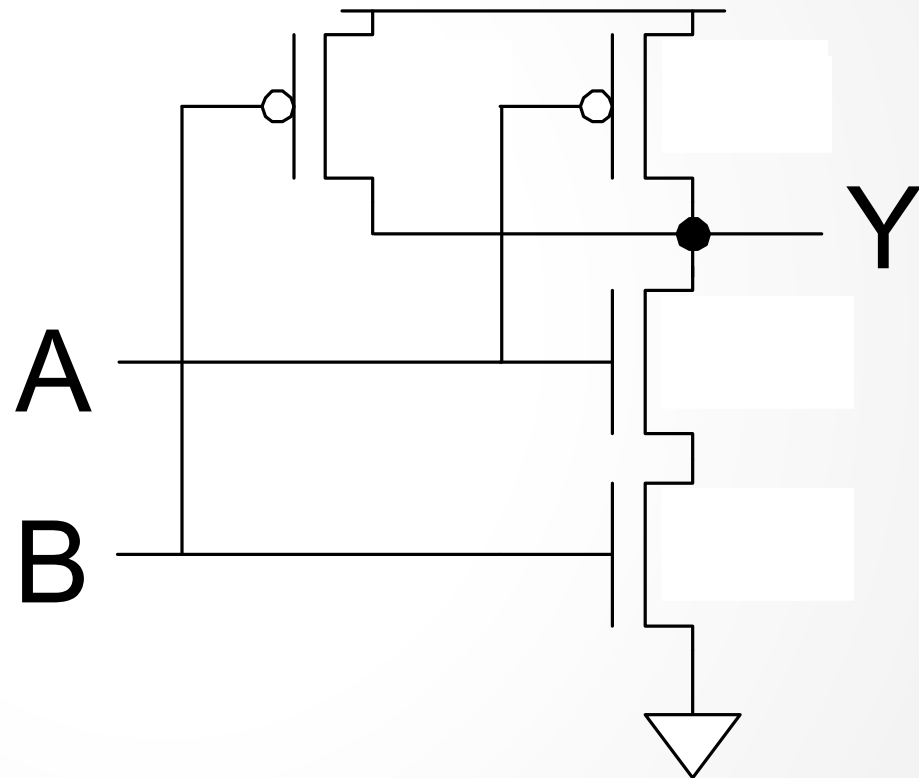
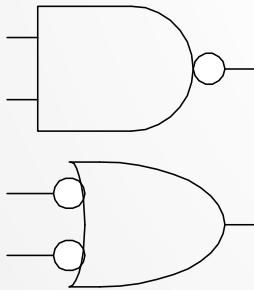

CMOS NOR Gate

A	B	Y
0	0	1
0	1	0
1	0	0
1	1	0

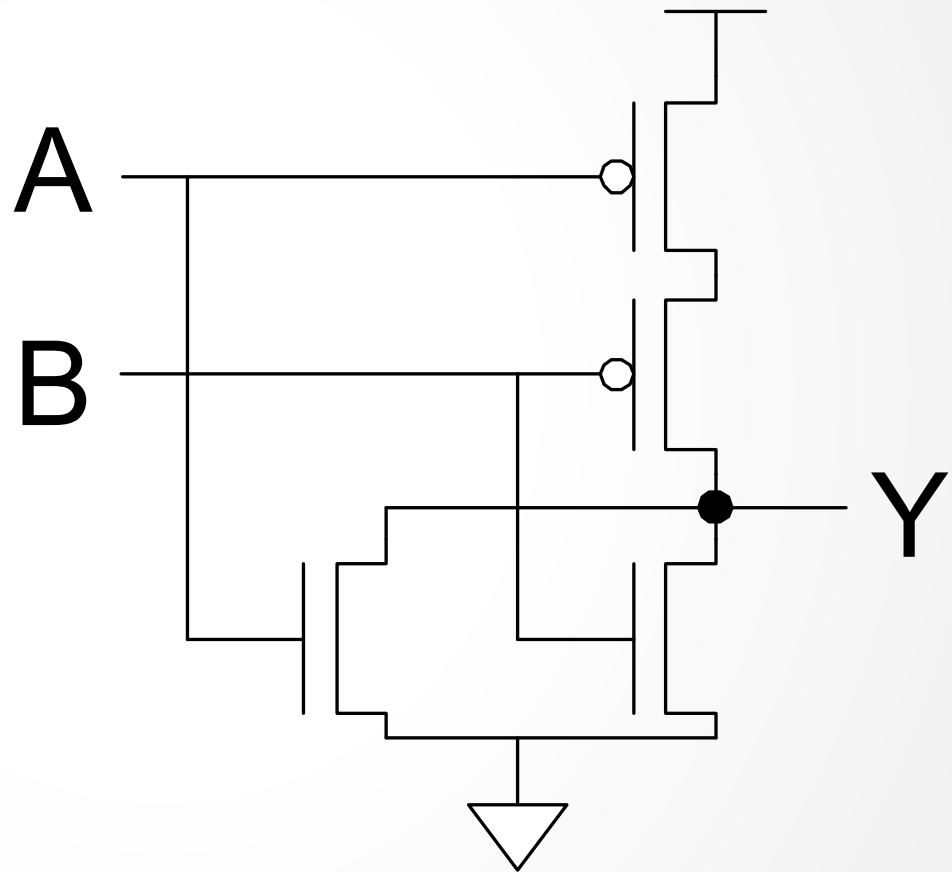
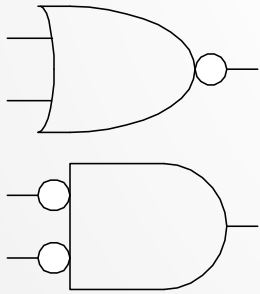

3-input NAND Gate

- Y pulls low if ALL inputs are 1
- Y pulls high if ANY input is 0

CMOS Fabrication

- CMOS transistors are fabricated on silicon wafer
- Lithography process similar to printing press
- On each step, different materials are deposited or etched
- Easiest to understand by viewing both top and cross-section of wafer in a simplified manufacturing process

Inverter Cross-section

- Typically use p-type substrate for nMOS transistors
- Requires n-well for body of pMOS transistors

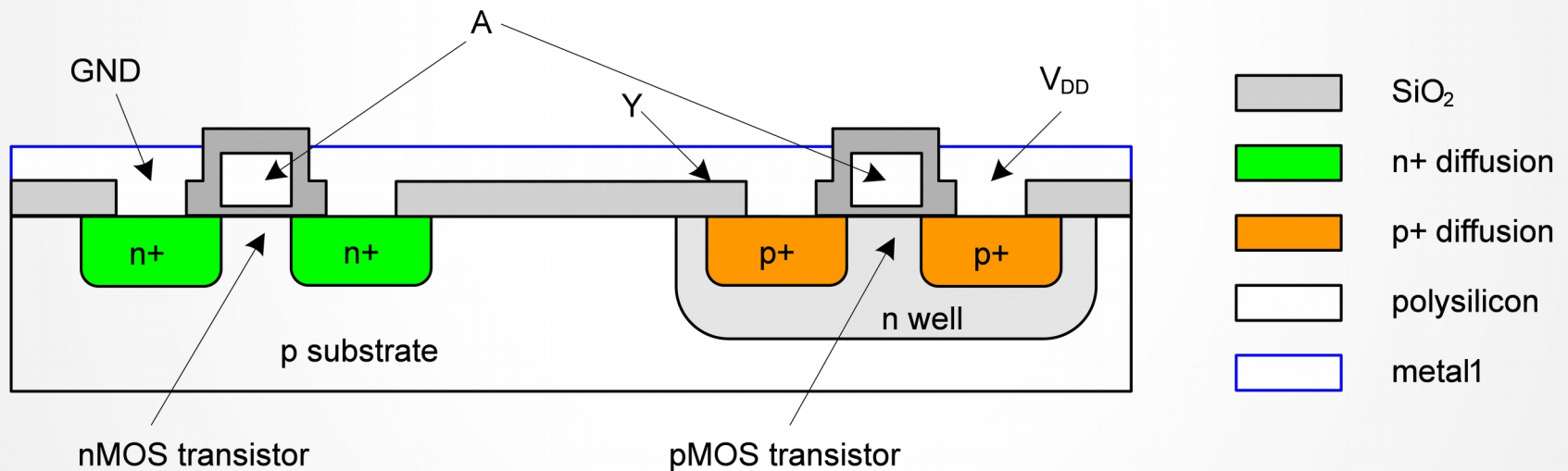

Well and Substrate Taps

- Substrate must be tied to GND and n-well to V_{DD}
- Metal to lightly-doped semiconductor forms poor connection called Schottky Diode
- Use heavily doped well and substrate contacts / taps

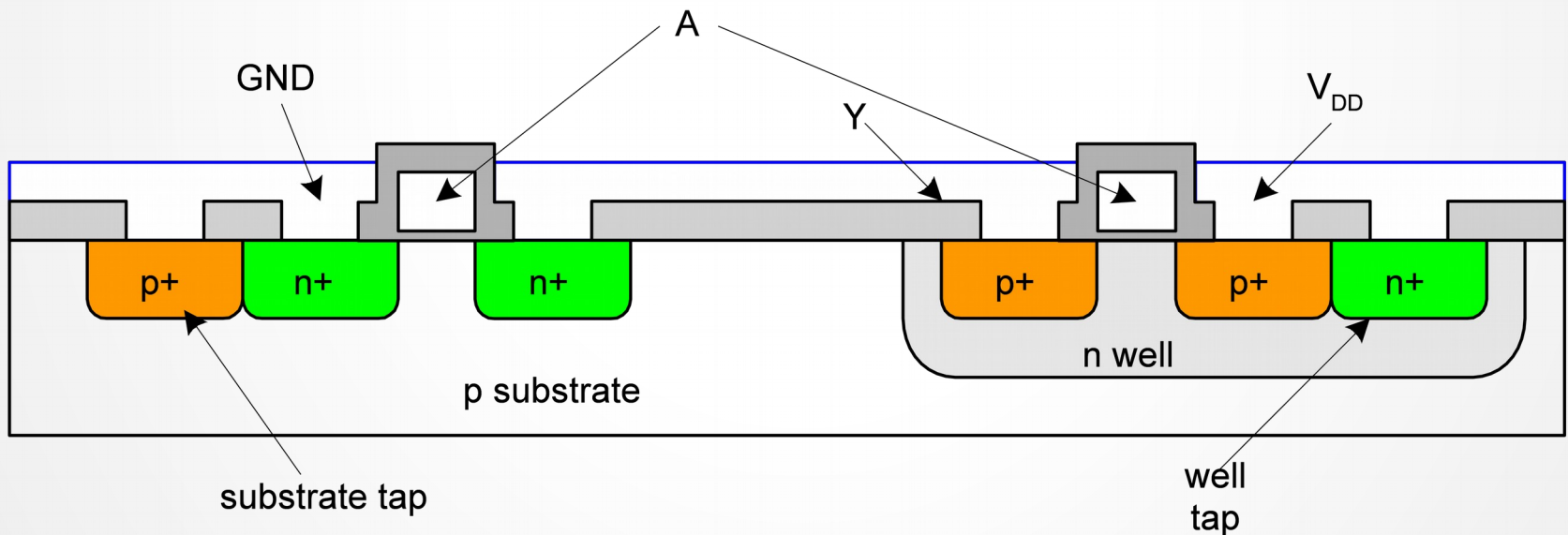

Inverter Mask Set

- Transistors and wires are defined by *masks*
- Cross-section taken along dashed line

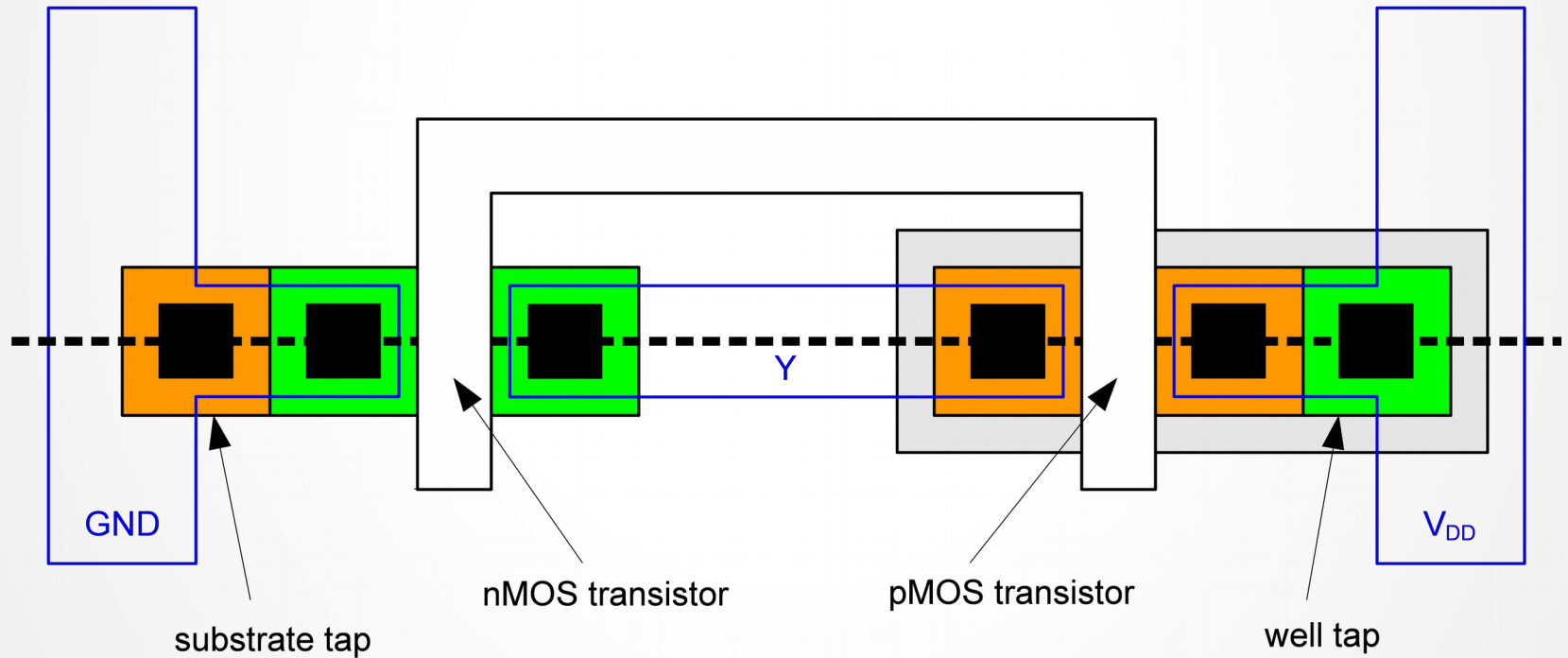

Detailed Mask Views

- Six masks
 - n-well
 - Polysilicon
 - n+ diffusion
 - p+ diffusion
 - Contact
 - Metal

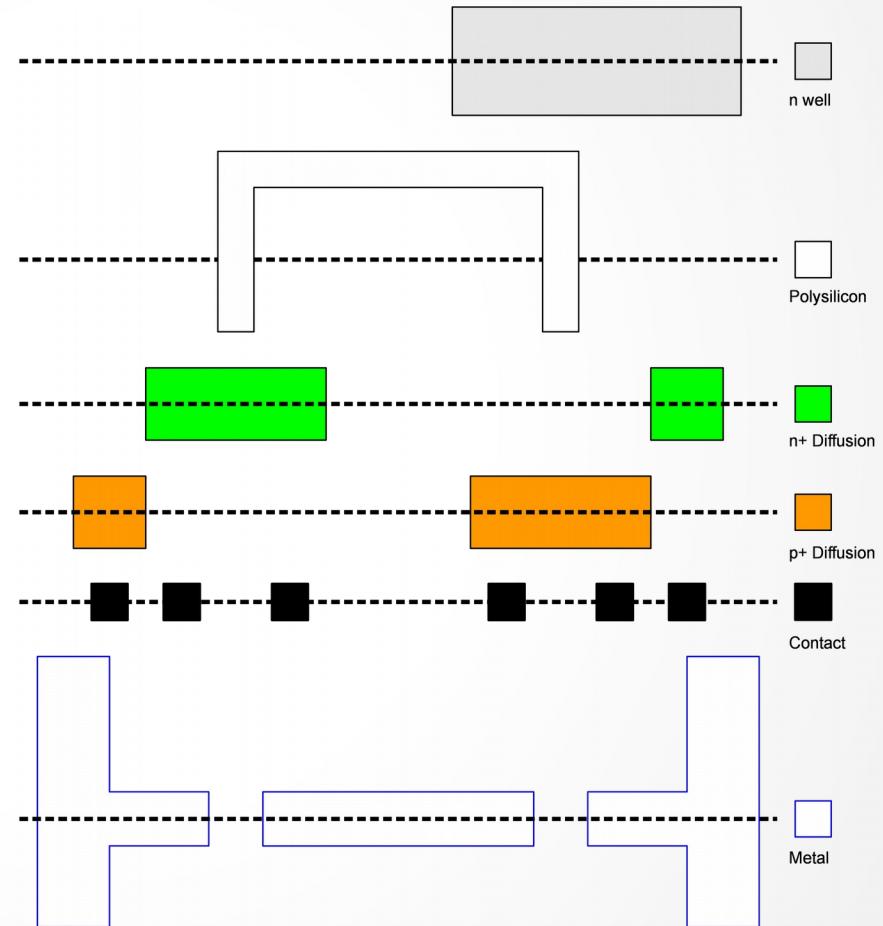

Fabrication

- Chips are built in huge factories called fabs
- Contain clean rooms as large as football fields



Courtesy of International
Business Machines Corporation.
Unauthorized use not permitted.

Fabrication Steps

- Start with blank wafer
- Build inverter from the bottom up
- First step will be to form the n-well
 - Cover wafer with protective layer of SiO_2 (oxide)
 - Remove layer where n-well should be built
 - Implant or diffuse n dopants into exposed wafer
 - Strip off SiO_2



p substrate

Oxidation

- Grow SiO_2 on top of Si wafer
 - 900 – 1200 C with H_2O or O_2 in oxidation furnace

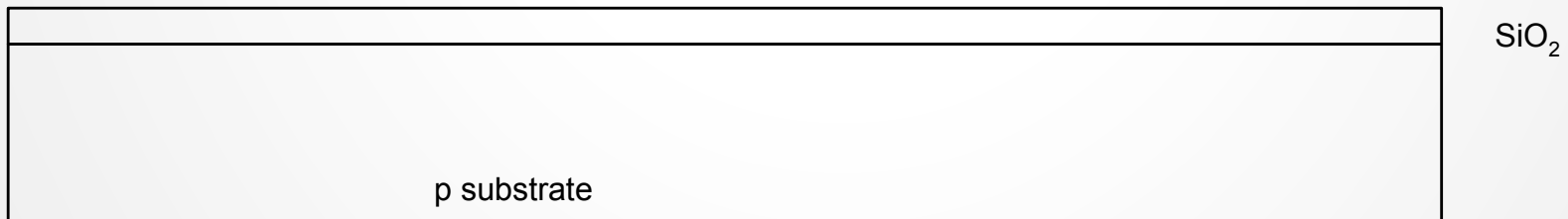

Photoresist

- Spin on photoresist
 - Photoresist is a light-sensitive organic polymer
 - Softens where exposed to light

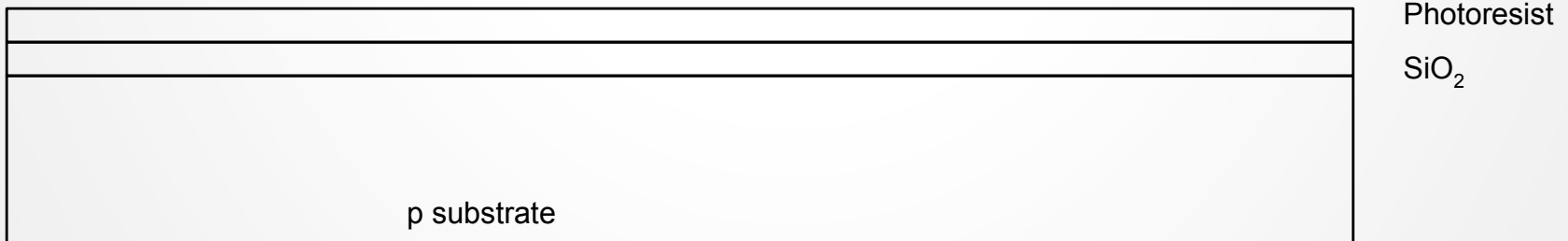

Lithography

- Expose photoresist through n-well mask
- Strip off exposed photoresist

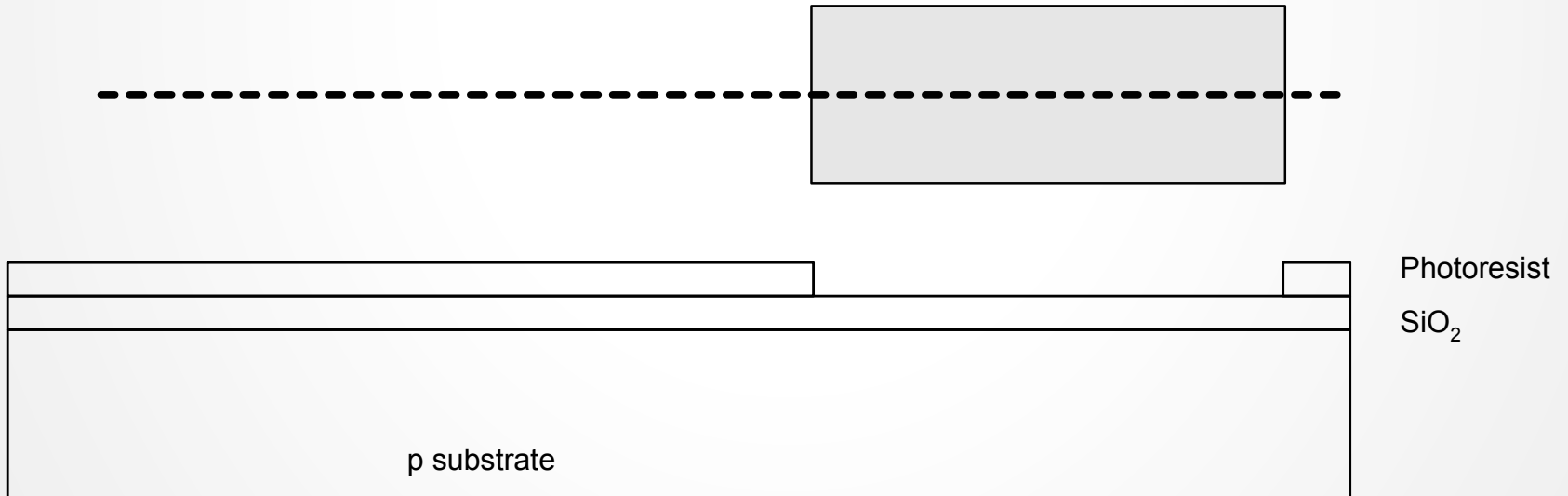

Etch

- Etch oxide with hydrofluoric acid (HF)
 - Seeps through skin and eats bone; nasty stuff!!!
- Only attacks oxide where resist has been exposed

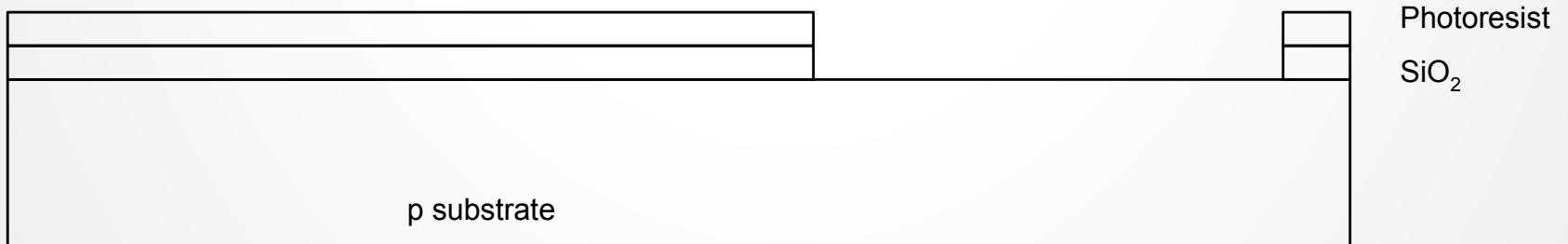

Strip Photoresist

- Strip off remaining photoresist
 - Use mixture of acids called piranha etch
- Necessary so resist doesn't melt in next step

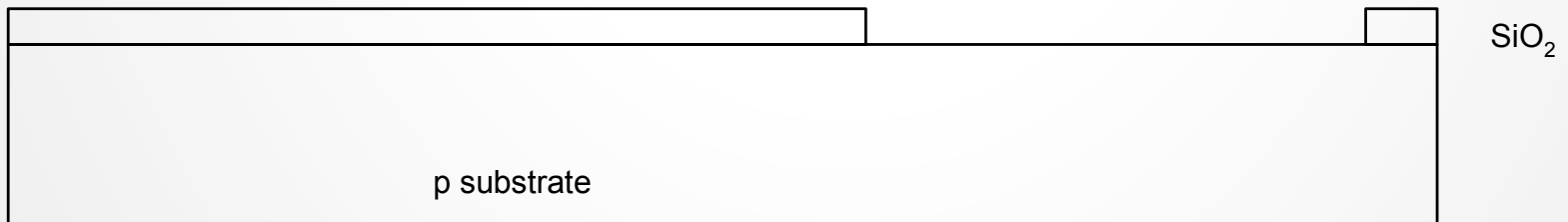

n-well

- n-well is formed with diffusion or ion implantation
- Diffusion
 - Place wafer in furnace with arsenic gas
 - Heat until As atoms diffuse into exposed Si
- Ion Implantation
 - Blast wafer with beam of As ions
 - Ions blocked by SiO_2 , only enter exposed Si

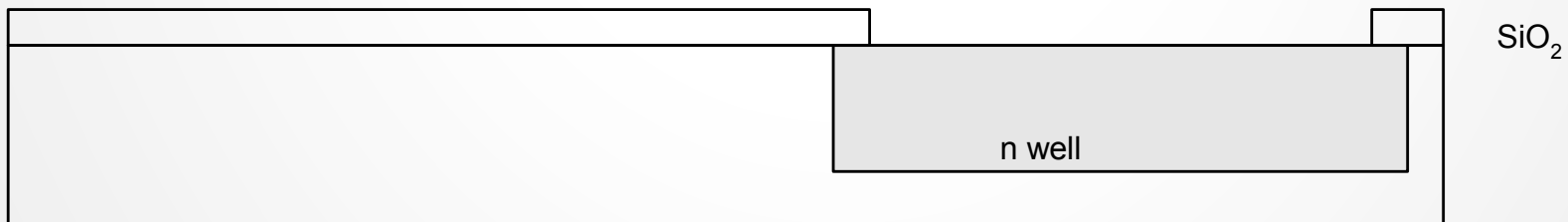

Strip Oxide

- Strip off the remaining oxide using HF
- Back to bare wafer with n-well
- Subsequent steps involve similar series of steps



Polysilicon

- Deposit very thin layer of gate oxide
 - $< 20 \text{ \AA}$ (6-7 atomic layers)
- Chemical Vapor Deposition (CVD) of silicon layer
 - Place wafer in furnace with Silane gas (SiH_4)
 - Forms many small crystals called polysilicon
 - Heavily doped to be good conductor

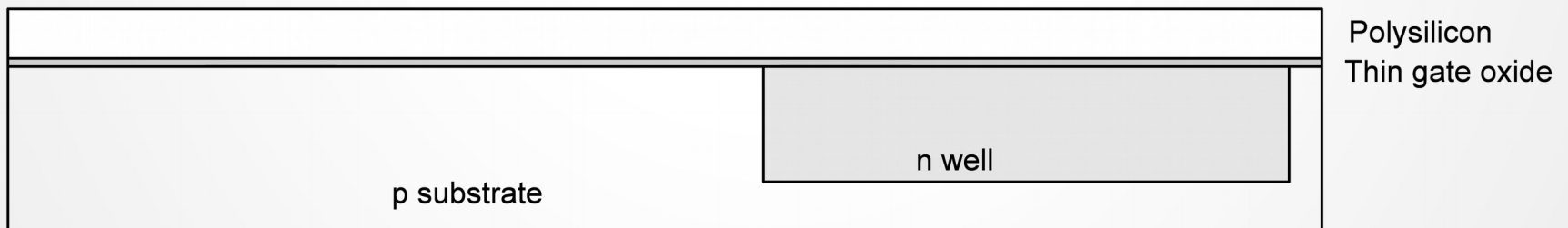

Polysilicon Patterning

- Use same lithography process to pattern polysilicon

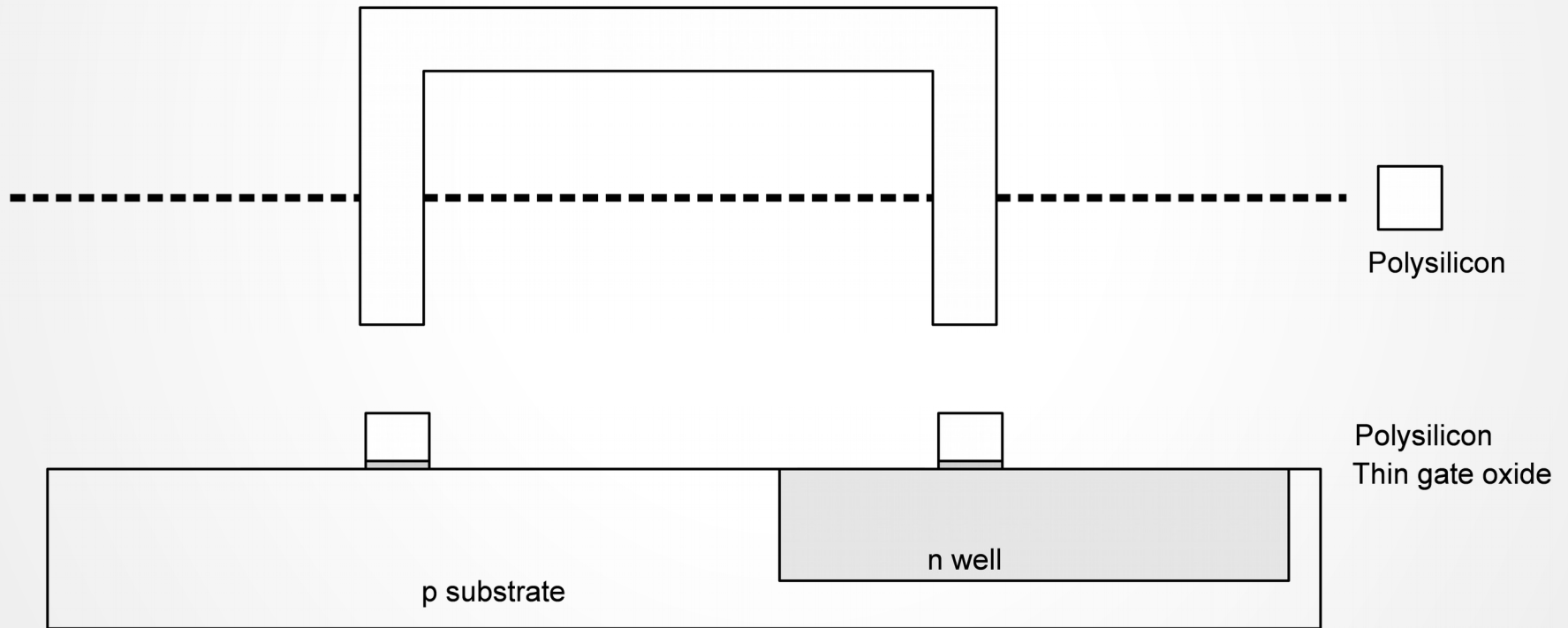

Self-Aligned Process

- Use oxide and masking to expose where n+ dopants should be diffused or implanted
- N-diffusion forms nMOS source, drain, and n-well contact

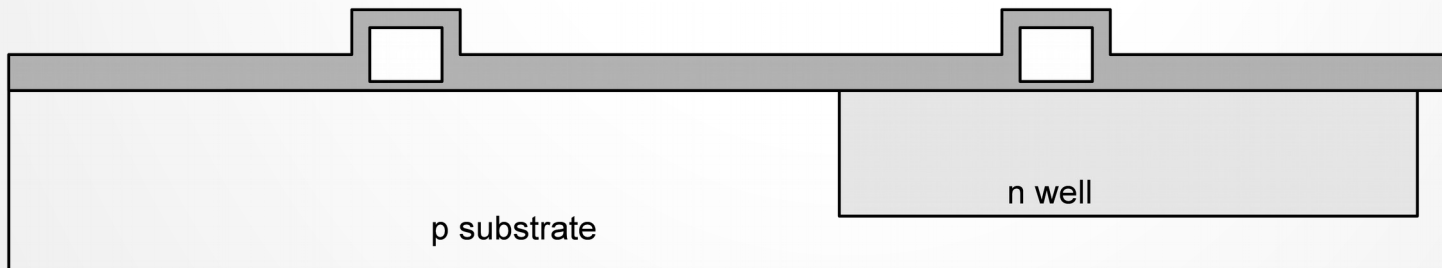

N-diffusion

- Pattern oxide and form n+ regions
- *Self-aligned process* where gate blocks diffusion
- Polysilicon is better than metal for self-aligned gates because it doesn't melt during later processing

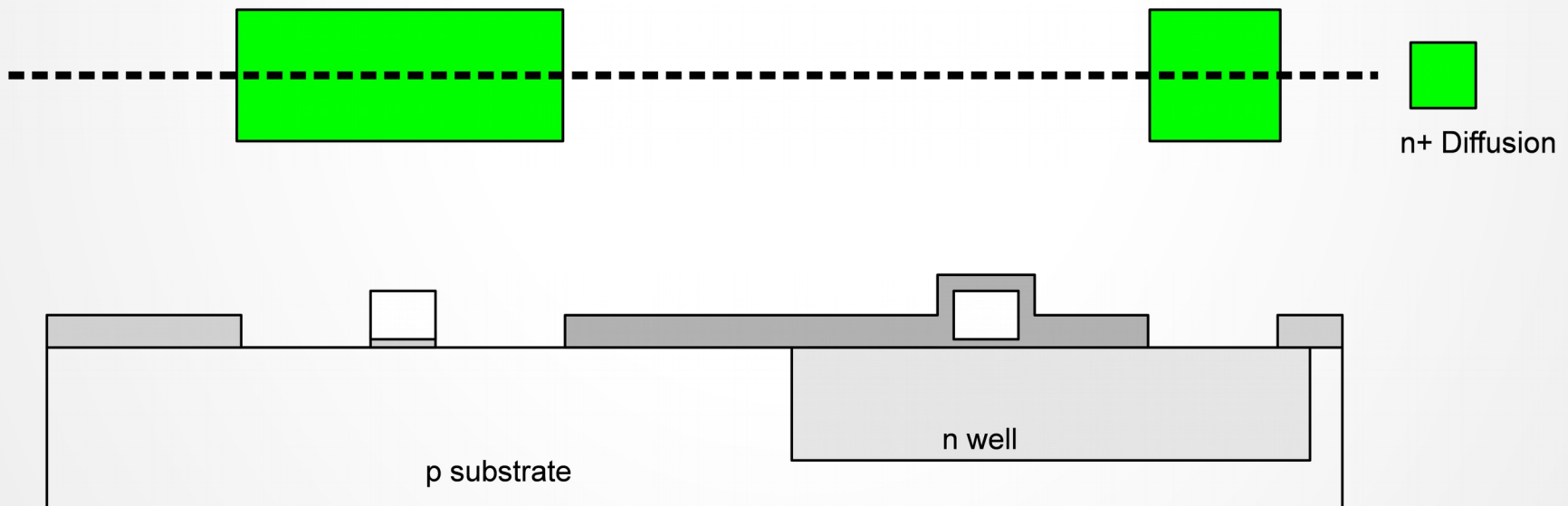

N-diffusion cont.

- Historically dopants were diffused
- Usually ion implantation today
- But regions are still called diffusion

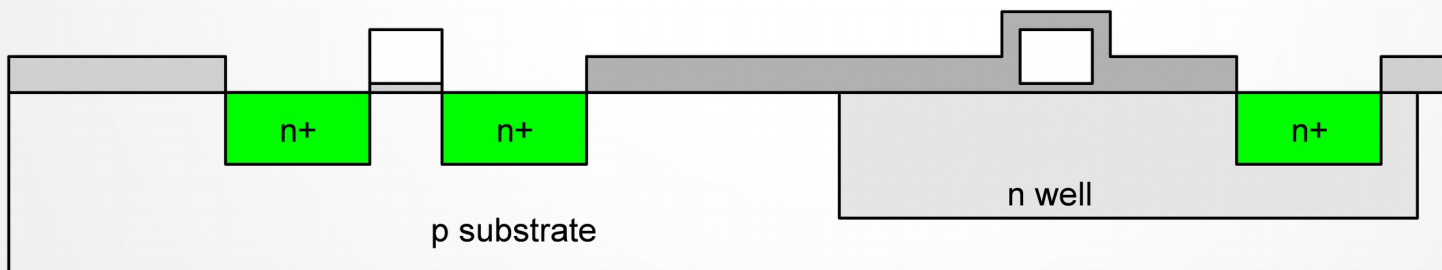

N-diffusion cont.

- Strip off oxide to complete patterning step

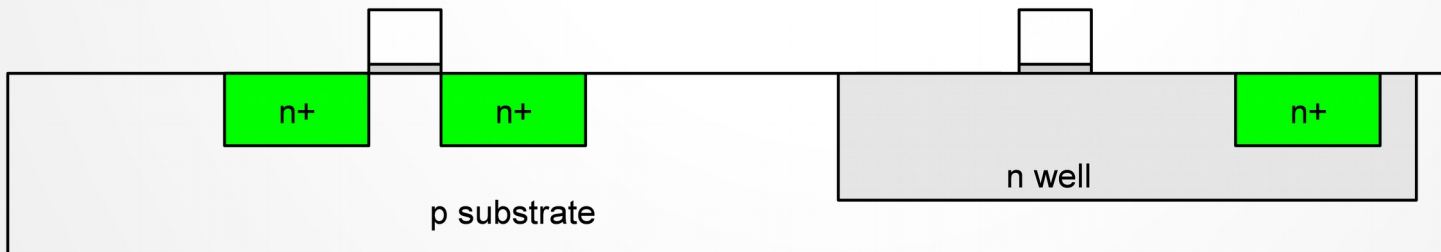

P-Diffusion

- Similar set of steps form p+ diffusion regions for pMOS source and drain and substrate contact

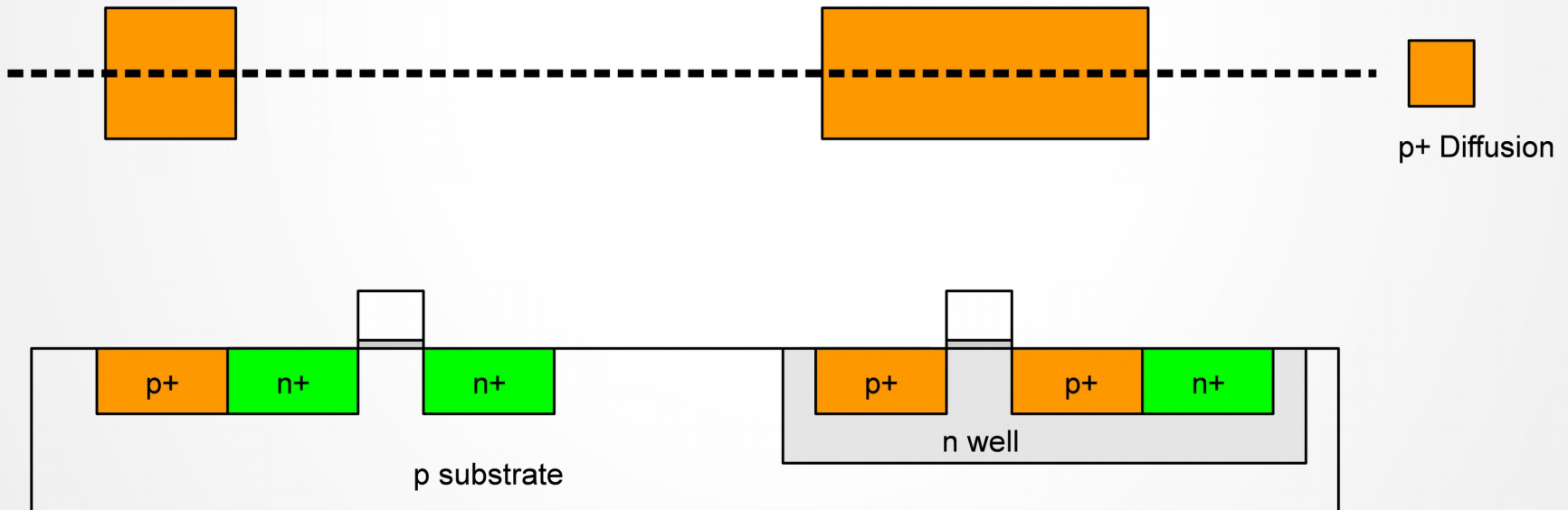

Contacts

- Now we need to wire together the devices
- Cover chip with thick field oxide
- Etch oxide where contact cuts are needed

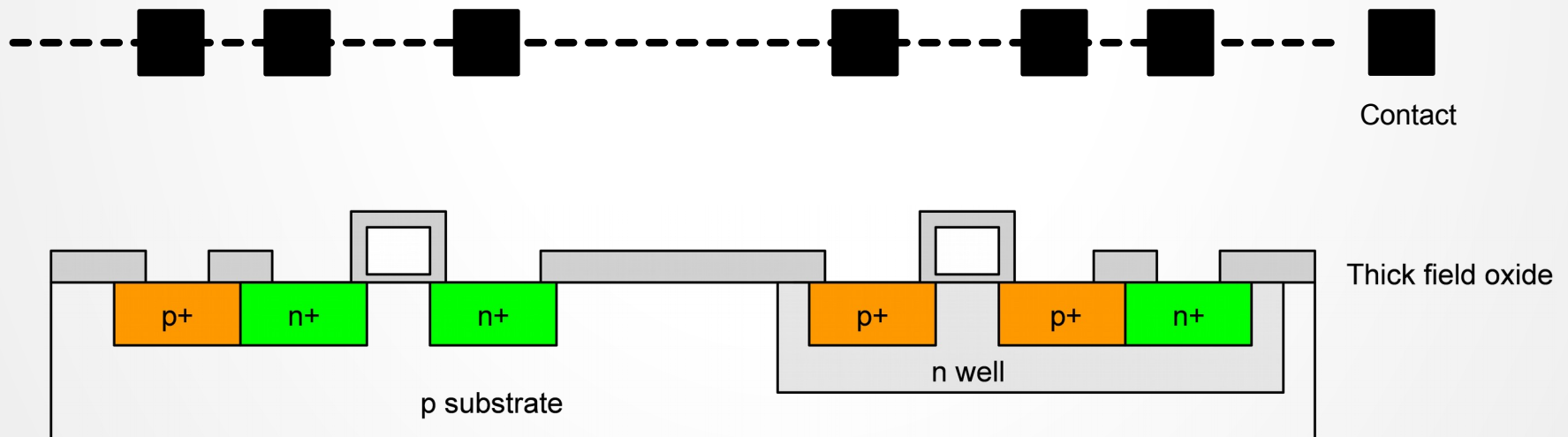

Metalization

- Sputter on aluminum over whole wafer
- Pattern to remove excess metal, leaving wires

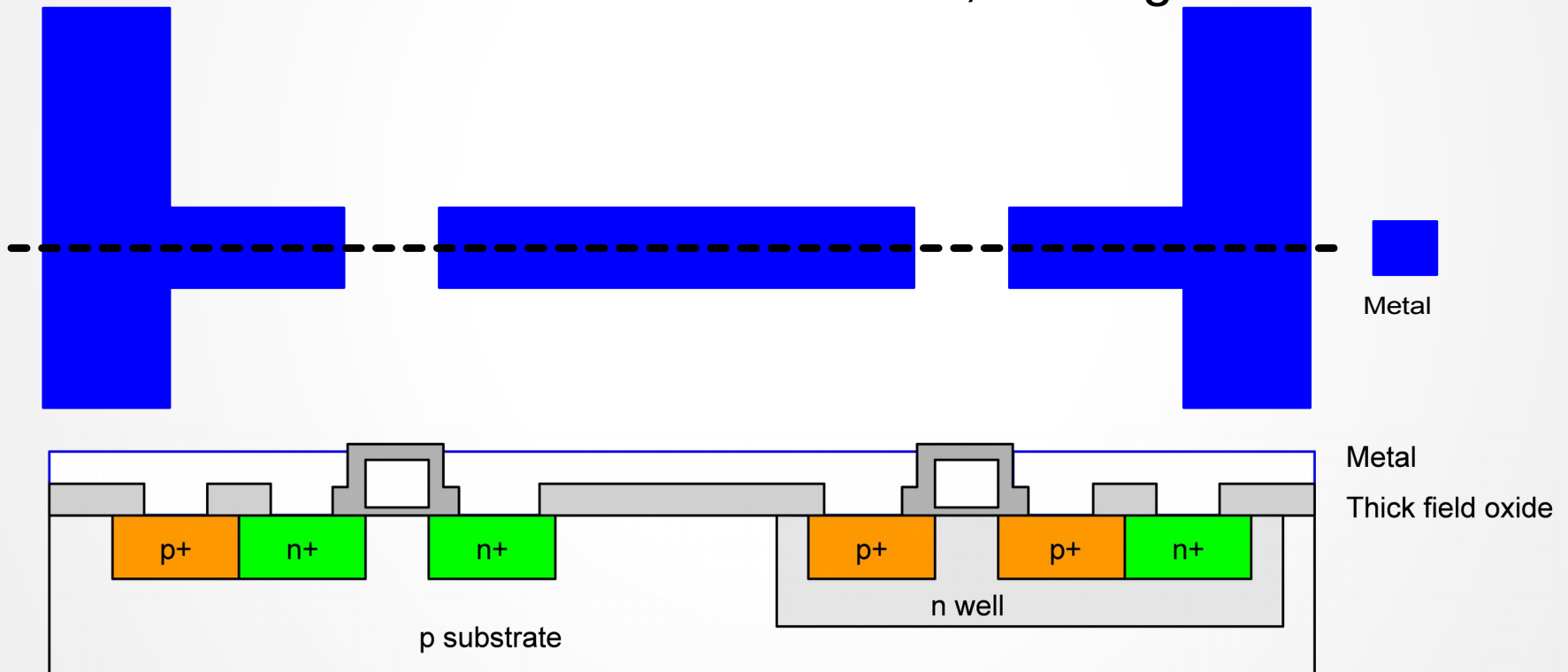

Layout

- Chips are specified with set of masks
- Minimum dimensions of masks determine transistor size (and hence speed, cost, and power)
- Feature size f = distance between source and drain
 - Set by minimum width of polysilicon
- Feature size improves 30% every 3 years or so
- Normalize for feature size when describing design rules
- Express rules in terms of $\lambda = f/2$
 - E.g. $\lambda = 0.3 \mu\text{m}$ in $0.6 \mu\text{m}$ process

Simplified Design Rules

- Conservative rules to get you started

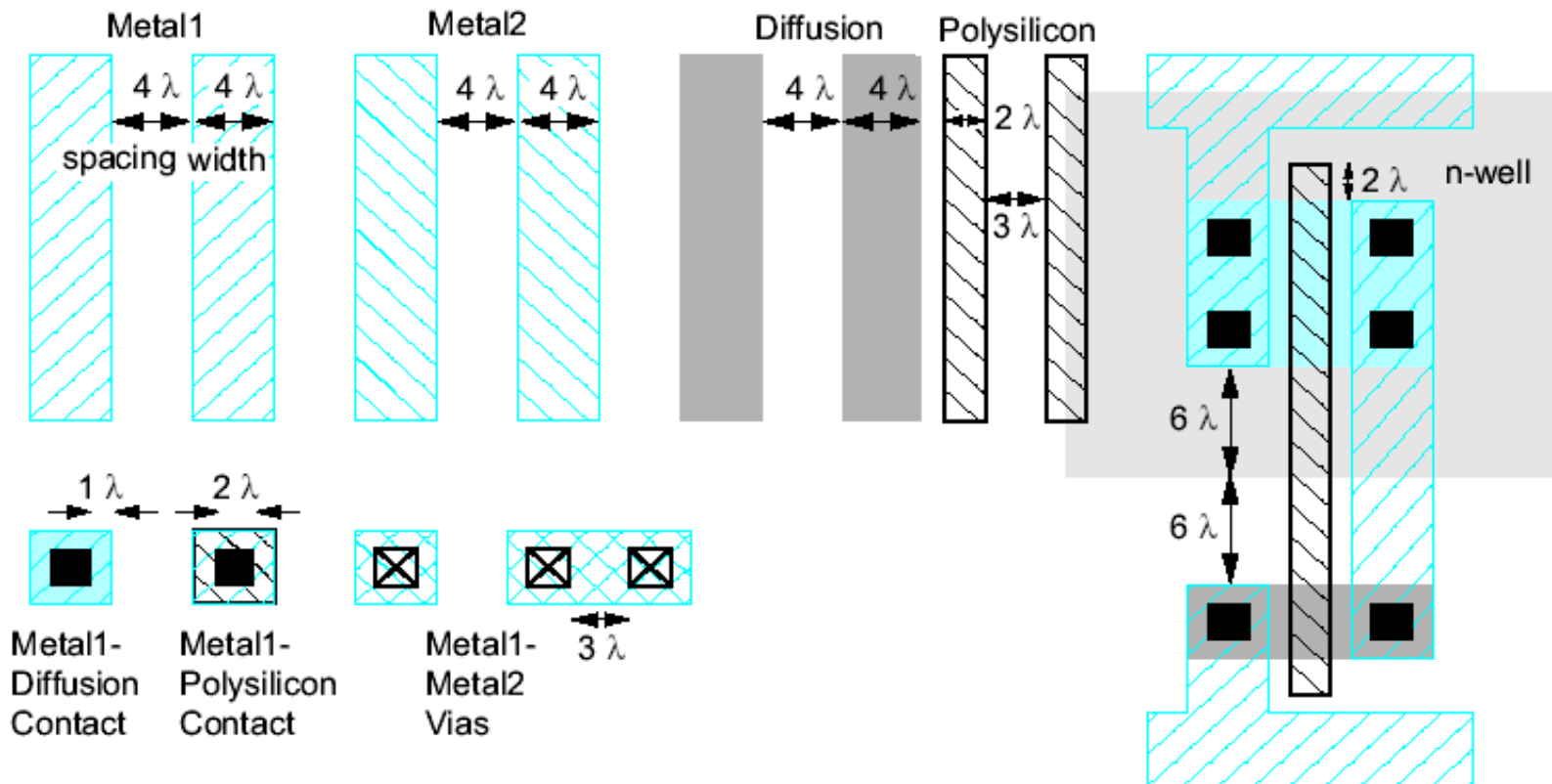

Inverter Layout

- Transistor dimensions specified as Width / Length
 - Minimum size is $4\lambda / 2\lambda$, sometimes called 1 unit
 - In $f = 0.6 \mu\text{m}$ process, this is $1.2 \mu\text{m}$ wide, $0.6 \mu\text{m}$ long

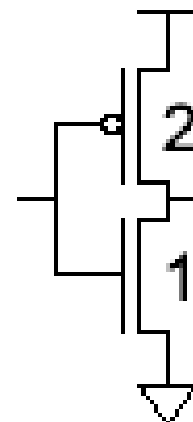
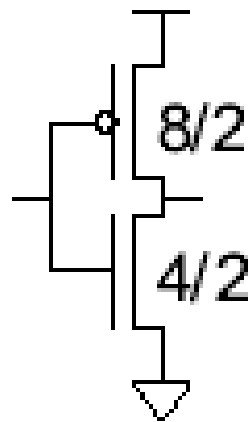
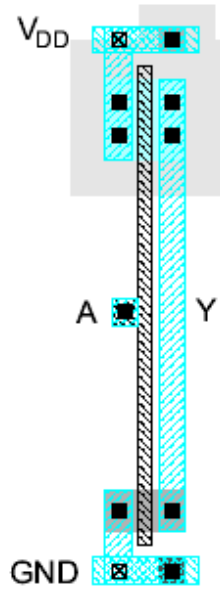

Silicon boule creation



Silicon Boule cut into slices => Wafers

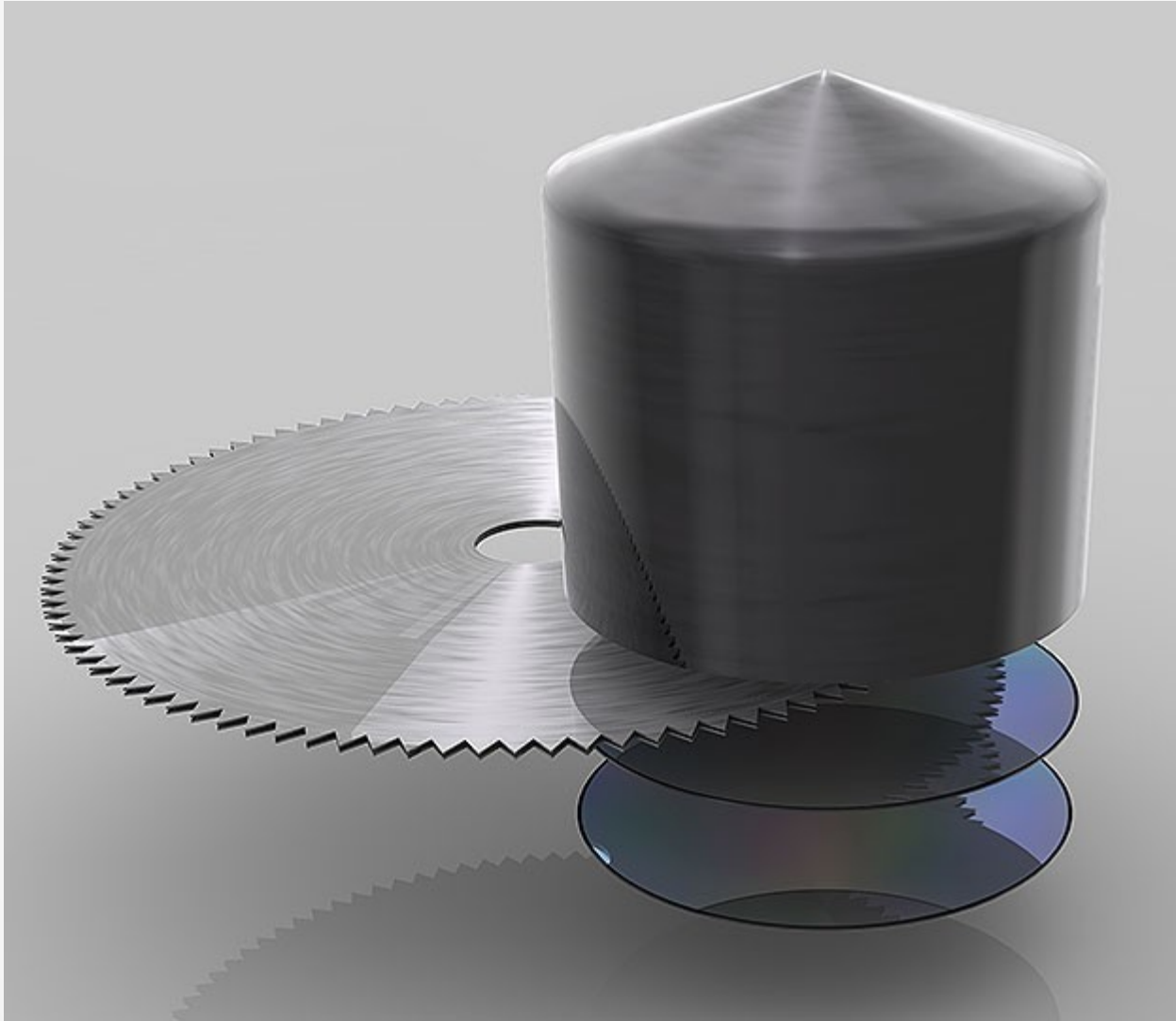

Exposing the Photoresist

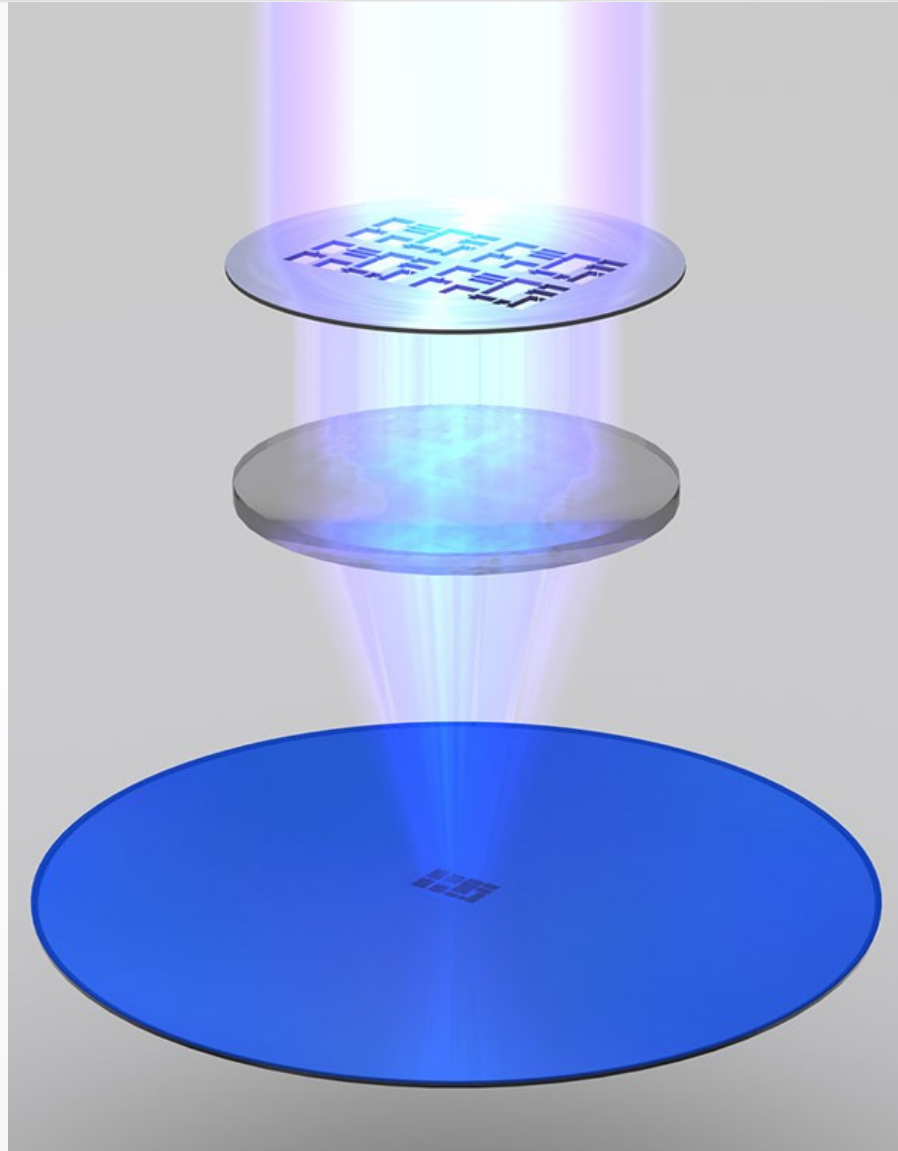

晶片的大小

- 晶圓的照片 (Wafer photo)

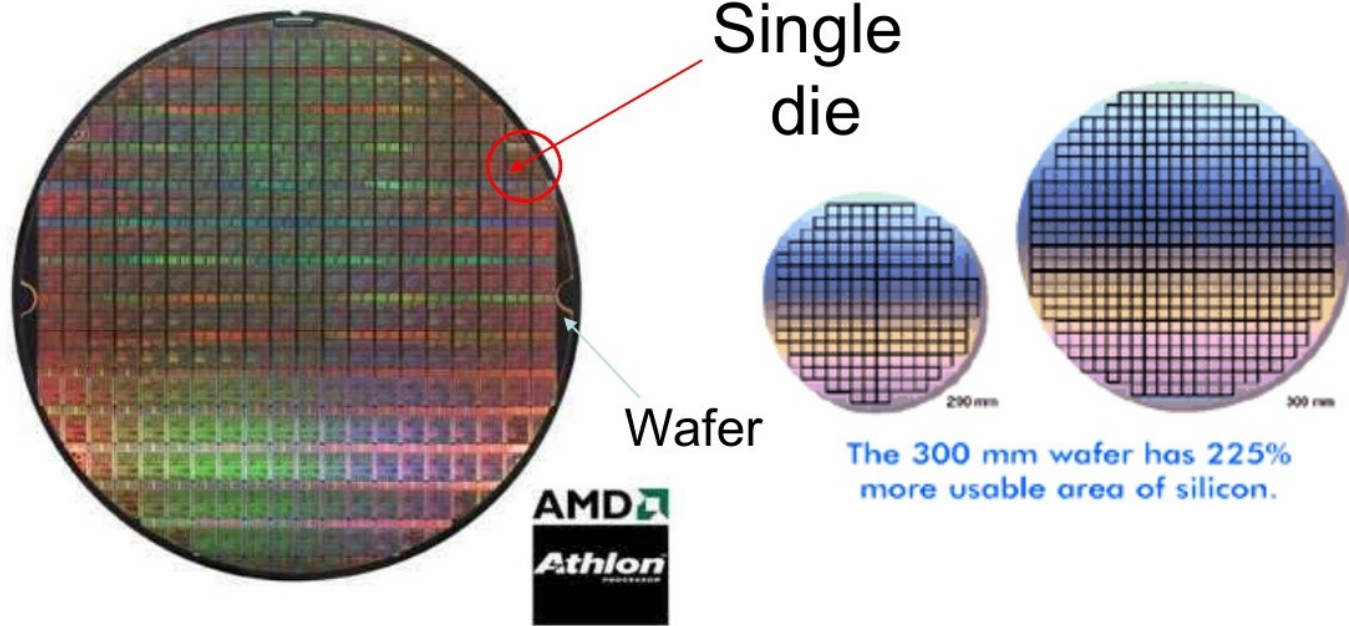

From <http://www.amd.com>

已提昇至 12" (30cm)

Wafer, Die, and IC

- Yield
- Defect density

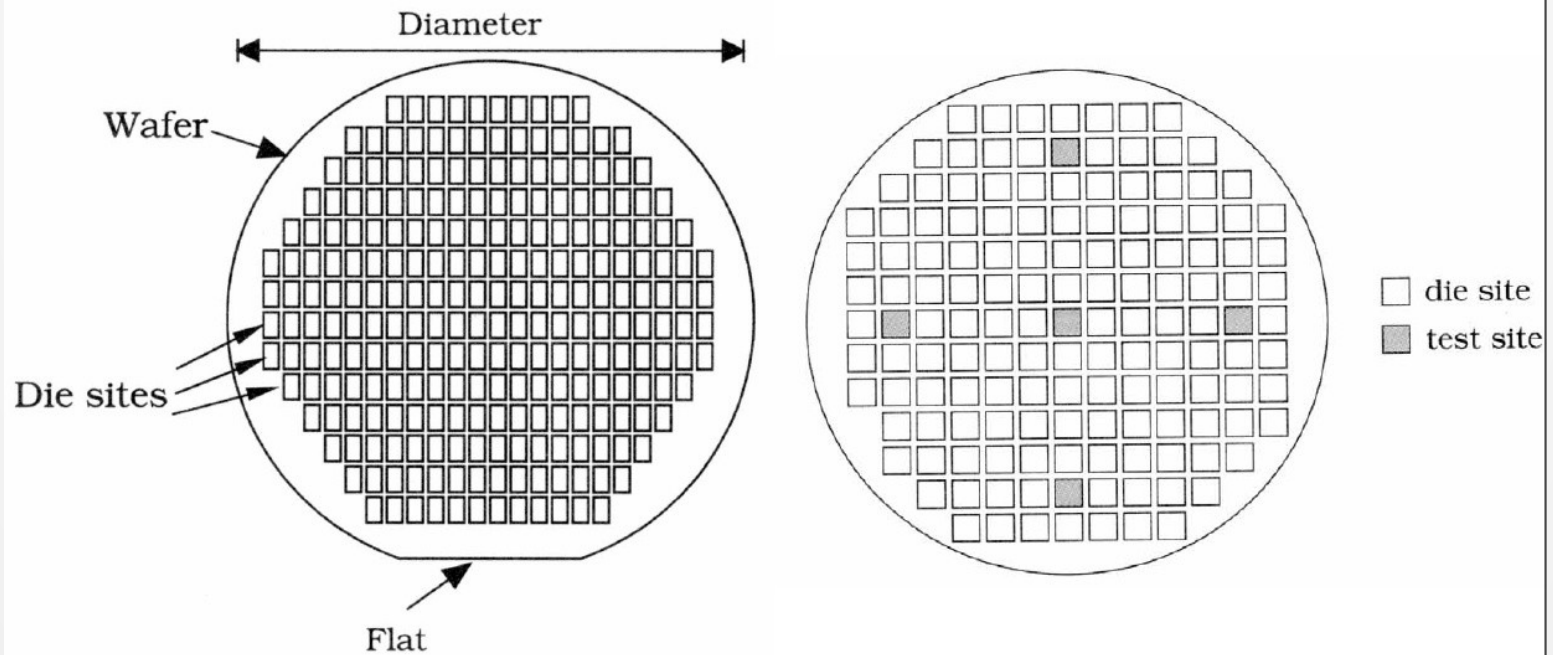

Summary

- MOS transistors are stacks of gate, oxide, silicon
- Act as electrically controlled switches
- Build logic gates out of switches
- Draw masks to specify layout of transistors

- Now you know everything necessary to start designing schematics and layout for a simple chip!

About these Notes

- Lecture notes © 2010 David Money Harris
- These notes may be used and modified for educational and/or non-commercial purposes so long as the source is attributed.