

# Spartan-6 Libraries Guide for Schematic Designs

UG616 (v14.7) October 2, 2013



## Notice of Disclaimer

The information disclosed to you hereunder (the "Materials") is provided solely for the selection and use of Xilinx products. To the maximum extent permitted by applicable law: (1) Materials are made available "AS IS" and with all faults, Xilinx hereby DISCLAIMS ALL WARRANTIES AND CONDITIONS, EXPRESS, IMPLIED, OR STATUTORY, INCLUDING BUT NOT LIMITED TO WARRANTIES OF MERCHANTABILITY, NON-INFRINGEMENT, OR FITNESS FOR ANY PARTICULAR PURPOSE; and (2) Xilinx shall not be liable (whether in contract or tort, including negligence, or under any other theory of liability) for any loss or damage of any kind or nature related to, arising under, or in connection with, the Materials (including your use of the Materials), including for any direct, indirect, special, incidental, or consequential loss or damage (including loss of data, profits, goodwill, or any type of loss or damage suffered as a result of any action brought by a third party) even if such damage or loss was reasonably foreseeable or Xilinx had been advised of the possibility of the same. Xilinx assumes no obligation to correct any errors contained in the Materials or to notify you of updates to the Materials or to product specifications. You may not reproduce, modify, distribute, or publicly display the Materials without prior written consent. Certain products are subject to the terms and conditions of the Limited Warranties which can be viewed at <http://www.xilinx.com/warranty.htm>; IP cores may be subject to warranty and support terms contained in a license issued to you by Xilinx. Xilinx products are not designed or intended to be fail-safe or for use in any application requiring fail-safe performance; you assume sole risk and liability for use of Xilinx products in Critical Applications: <http://www.xilinx.com/warranty.htm#critapps>.

© Copyright 2002-2013 Xilinx Inc. All rights reserved. Xilinx, the Xilinx logo, Artix, ISE, Kintex, Spartan, Virtex, Vivado, Zynq, and other designated brands included herein are trademarks of Xilinx in the United States and other countries. All other trademarks are the property of their respective owners.

# Introduction

---

This schematic guide is part of the ISE documentation collection. A separate version of this guide is available if you prefer to work with HDL.

This guide contains the following:

- Introduction.
- A list of design elements supported in this architecture, organized by functional categories.
- Individual descriptions of each available primitive.

## About Design Elements

This version of the Libraries Guide describes design elements available for Spartan®-6 devices. There are several categories of design elements:

- **Primitives** - The simplest design elements in the Xilinx libraries. Primitives are the design element "atoms." Examples of Xilinx primitives are the simple buffer, BUF, and the D flip-flop with clock enable and clear, FDCE.
- **Macros** - The design element "molecules" of the Xilinx libraries. Macros can be created from the design element primitives or macros. For example, the FD4CE flip-flop macro is a composite of 4 FDCE primitives.

Xilinx maintains software libraries with hundreds of functional design elements (macros and primitives) for different device architectures. New functional elements are assembled with each release of development system software. This guide is one in a series of architecture-specific libraries.





## Functional Categories

This section categorizes, by function, the circuit design elements described in detail later in this guide. The elements (*primitives* and *macros*) are listed in alphanumeric order under each functional category.

Advanced	Decoder	Logic
Arithmetic	Flip Flop	LUT
Buffer	General	Memory
Carry Logic	Input/Output Functions	Mux
Clocking Resources	IO	Shift Register
Comparator	IO FlipFlop	Shifter
Counter	IO Latch	
DDR Flip Flop	Latch	

### Advanced

Design Element	Description
<a href="#">GTPA1_DUAL</a>	Primitive: Dual Gigabit Transceiver
<a href="#">PCIE_A1</a>	Primitive: PCI Express

### Arithmetic

Design Element	Description
<a href="#">ACC16</a>	Macro: 16-Bit Loadable Cascadable Accumulator with Carry-In, Carry-Out, and Synchronous Reset
<a href="#">ACC4</a>	Macro: 4-Bit Loadable Cascadable Accumulator with Carry-In, Carry-Out, and Synchronous Reset
<a href="#">ACC8</a>	Macro: 8-Bit Loadable Cascadable Accumulator with Carry-In, Carry-Out, and Synchronous Reset
<a href="#">ADD16</a>	Macro: 16-Bit Cascadable Full Adder with Carry-In, Carry-Out, and Overflow
<a href="#">ADD4</a>	Macro: 4-Bit Cascadable Full Adder with Carry-In, Carry-Out, and Overflow
<a href="#">ADD8</a>	Macro: 8-Bit Cascadable Full Adder with Carry-In, Carry-Out, and Overflow

Design Element	Description
<a href="#">ADSU16</a>	Macro: 16-Bit Cascadable Adder/Subtractor with Carry-In, Carry-Out, and Overflow
<a href="#">ADSU4</a>	Macro: 4-Bit Cascadable Adder/Subtractor with Carry-In, Carry-Out, and Overflow
<a href="#">ADSU8</a>	Macro: 8-Bit Cascadable Adder/Subtractor with Carry-In, Carry-Out, and Overflow
<a href="#">DSP48A1</a>	Primitive: Multi-Functional, Cascadable, 48-bit Output, Arithmetic Block
<a href="#">MULT18X18SIO</a>	Primitive: 18 x 18 Cascadable Signed Multiplier with Optional Input and Output Registers, Clock Enable, and Synchronous Reset

### Buffer

Design Element	Description
<a href="#">BUF</a>	Primitive: General Purpose Buffer
<a href="#">BUFCF</a>	Primitive: Fast Connect Buffer
<a href="#">BUFG</a>	Primitive: Global Clock Buffer
<a href="#">BUFGCE</a>	Primitive: Global Clock Buffer with Clock Enable
<a href="#">BUFGCE_1</a>	Primitive: Global Clock Buffer with Clock Enable and Output State 1
<a href="#">BUFGMUX</a>	Primitive: Global Clock MUX Buffer
<a href="#">BUFGMUX_1</a>	Primitive: Global Clock MUX Buffer with Output State 1
<a href="#">BUFGP</a>	Primitive: Global Buffer for Driving Clocks

### Carry Logic

Design Element	Description
<a href="#">CARRY4</a>	Primitive: Fast Carry Logic with Look Ahead
<a href="#">MUXCY</a>	Primitive: 2-to-1 Multiplexer for Carry Logic with General Output
<a href="#">MUXCY_D</a>	Primitive: 2-to-1 Multiplexer for Carry Logic with Dual Output
<a href="#">MUXCY_L</a>	Primitive: 2-to-1 Multiplexer for Carry Logic with Local Output
<a href="#">XORCY</a>	Primitive: XOR for Carry Logic with General Output
<a href="#">XORCY_D</a>	Primitive: XOR for Carry Logic with Dual Output
<a href="#">XORCY_L</a>	Primitive: XOR for Carry Logic with Local Output

### Clocking Resources

Design Element	Description
<a href="#">BUFIO2</a>	Primitive: Dual Clock Buffer and Strobe Pulse
<a href="#">BUFIO2_2CLK</a>	Primitive: Dual Clock Buffer and Strobe Pulse with Differential Input
<a href="#">BUFIO2FB</a>	Primitive: Feedback Clock Buffer
<a href="#">BUFH</a>	Primitive: Clock buffer for a single clocking region
<a href="#">BUFPLL</a>	Primitive: PLL Buffer
<a href="#">DCM_SP</a>	Primitive: Digital Clock Manager
<a href="#">DCM_CLKGEN</a>	Primitive: Digital Clock Manager.
<a href="#">PLL_BASE</a>	Primitive: Basic Phase Locked Loop Clock Circuit

### Comparator

Design Element	Description
<a href="#">COMP16</a>	Macro: 16-Bit Identity Comparator
<a href="#">COMP2</a>	Macro: 2-Bit Identity Comparator
<a href="#">COMP4</a>	Macro: 4-Bit Identity Comparator
<a href="#">COMP8</a>	Macro: 8-Bit Identity Comparator
<a href="#">COMPM16</a>	Macro: 16-Bit Magnitude Comparator
<a href="#">COMPM2</a>	Macro: 2-Bit Magnitude Comparator
<a href="#">COMPM4</a>	Macro: 4-Bit Magnitude Comparator
<a href="#">COMPM8</a>	Macro: 8-Bit Magnitude Comparator
<a href="#">COMPMC16</a>	Macro: 16-Bit Magnitude Comparator
<a href="#">COMPMC8</a>	Macro: 8-Bit Magnitude Comparator

### Counter

Design Element	Description
<a href="#">CB2CE</a>	Macro: 2-Bit Cascadable Binary Counter with Clock Enable and Asynchronous Clear
<a href="#">CB2CLE</a>	Macro: 2-Bit Loadable Cascadable Binary Counters with Clock Enable and Asynchronous Clear
<a href="#">CB2CLED</a>	Macro: 2-Bit Loadable Cascadable Bidirectional Binary Counters with Clock Enable and Asynchronous Clear
<a href="#">CB2RE</a>	Macro: 2-Bit Cascadable Binary Counter with Clock Enable and Synchronous Reset
<a href="#">CB4CE</a>	Macro: 4-Bit Cascadable Binary Counter with Clock Enable and Asynchronous Clear
<a href="#">CB4CLE</a>	Macro: 4-Bit Loadable Cascadable Binary Counters with Clock Enable and Asynchronous Clear
<a href="#">CB4CLED</a>	Macro: 4-Bit Loadable Cascadable Bidirectional Binary Counters with Clock Enable and Asynchronous Clear

Design Element	Description
CB4RE	Macro: 4-Bit Cascadable Binary Counter with Clock Enable and Synchronous Reset
CB8CE	Macro: 8-Bit Cascadable Binary Counter with Clock Enable and Asynchronous Clear
CB8CLE	Macro: 8-Bit Loadable Cascadable Binary Counters with Clock Enable and Asynchronous Clear
CB8CLED	Macro: 8-Bit Loadable Cascadable Bidirectional Binary Counters with Clock Enable and Asynchronous Clear
CB8RE	Macro: 8-Bit Cascadable Binary Counter with Clock Enable and Synchronous Reset
CB16CE	Macro: 16-Bit Cascadable Binary Counter with Clock Enable and Asynchronous Clear
CB16CLE	Macro: 16-Bit Loadable Cascadable Binary Counters with Clock Enable and Asynchronous Clear
CB16CLED	Macro: 16-Bit Loadable Cascadable Bidirectional Binary Counters with Clock Enable and Asynchronous Clear
CB16RE	Macro: 16-Bit Cascadable Binary Counter with Clock Enable and Synchronous Reset
CC16CE	Macro: 16-Bit Cascadable Binary Counter with Clock Enable and Asynchronous Clear
CC16CLE	Macro: 16-Bit Loadable Cascadable Binary Counter with Clock Enable and Asynchronous Clear
CC16CLED	Macro: 16-Bit Loadable Cascadable Bidirectional Binary Counter with Clock Enable and Asynchronous Clear
CC16RE	Macro: 16-Bit Cascadable Binary Counter with Clock Enable and Synchronous Reset
CC8CE	Macro: 8-Bit Cascadable Binary Counter with Clock Enable and Asynchronous Clear
CC8CLE	Macro: 8-Bit Loadable Cascadable Binary Counter with Clock Enable and Asynchronous Clear
CC8CLED	Macro: 8-Bit Loadable Cascadable Bidirectional Binary Counter with Clock Enable and Asynchronous Clear
CC8RE	Macro: 8-Bit Cascadable Binary Counter with Clock Enable and Synchronous Reset
CD4CE	Macro: 4-Bit Cascadable BCD Counter with Clock Enable and Asynchronous Clear
CD4CLE	Macro: 4-Bit Loadable Cascadable BCD Counter with Clock Enable and Asynchronous Clear
CD4RE	Macro: 4-Bit Cascadable BCD Counter with Clock Enable and Synchronous Reset
CD4RLE	Macro: 4-Bit Loadable Cascadable BCD Counter with Clock Enable and Synchronous Reset
CJ4CE	Macro: 4-Bit Johnson Counter with Clock Enable and Asynchronous Clear
CJ4RE	Macro: 4-Bit Johnson Counter with Clock Enable and Synchronous Reset
CJ5CE	Macro: 5-Bit Johnson Counter with Clock Enable and Asynchronous Clear

Design Element	Description
CJ5RE	Macro: 5-Bit Johnson Counter with Clock Enable and Synchronous Reset
CJ8CE	Macro: 8-Bit Johnson Counter with Clock Enable and Asynchronous Clear
CJ8RE	Macro: 8-Bit Johnson Counter with Clock Enable and Synchronous Reset
CR16CE	Macro: 16-Bit Negative-Edge Binary Ripple Counter with Clock Enable and Asynchronous Clear
CR8CE	Macro: 8-Bit Negative-Edge Binary Ripple Counter with Clock Enable and Asynchronous Clear

### DDR Flip Flop

Design Element	Description
IDDR2	Primitive: Double Data Rate Input D Flip-Flop with Optional Data Alignment, Clock Enable and Programmable Synchronous or Asynchronous Set/Reset
ODDR2	Primitive: Dual Data Rate Output D Flip-Flop with Optional Data Alignment, Clock Enable and Programmable Synchronous or Asynchronous Set/Reset

### Decoder

Design Element	Description
D2_4E	Macro: 2- to 4-Line Decoder/Demultiplexer with Enable
D3_8E	Macro: 3- to 8-Line Decoder/Demultiplexer with Enable
D4_16E	Macro: 4- to 16-Line Decoder/Demultiplexer with Enable
DEC_CC16	Macro: 16-Bit Active Low Decoder
DEC_CC4	Macro: 4-Bit Active Low Decoder
DEC_CC8	Macro: 8-Bit Active Low Decoder
DECODE16	Macro: 16-Bit Active-Low Decoder
DECODE32	Macro: 32-Bit Active-Low Decoder
DECODE4	Macro: 4-Bit Active-Low Decoder
DECODE64	Macro: 64-Bit Active-Low Decoder
DECODE8	Macro: 8-Bit Active-Low Decoder

### Flip Flop

Design Element	Description
FD	Primitive: D Flip-Flop
FD_1	Primitive: D Flip-Flop with Negative-Edge Clock
FD16CE	Macro: 16-Bit Data Register with Clock Enable and Asynchronous Clear
FD16RE	Macro: 16-Bit Data Register with Clock Enable and Synchronous Reset

Design Element	Description
FD4CE	Macro: 4-Bit Data Register with Clock Enable and Asynchronous Clear
FD4RE	Macro: 4-Bit Data Register with Clock Enable and Synchronous Reset
FD8CE	Macro: 8-Bit Data Register with Clock Enable and Asynchronous Clear
FD8RE	Macro: 8-Bit Data Register with Clock Enable and Synchronous Reset
FDC	Primitive: D Flip-Flop with Asynchronous Clear
FDC_1	Primitive: D Flip-Flop with Negative-Edge Clock and Asynchronous Clear
FDCE	Primitive: D Flip-Flop with Clock Enable and Asynchronous Clear
FDCE_1	Primitive: D Flip-Flop with Negative-Edge Clock, Clock Enable, and Asynchronous Clear
FDE	Primitive: D Flip-Flop with Clock Enable
FDE_1	Primitive: D Flip-Flop with Negative-Edge Clock and Clock Enable
FDP	Primitive: D Flip-Flop with Asynchronous Preset
FDP_1	Primitive: D Flip-Flop with Negative-Edge Clock and Asynchronous Preset
FDPE	Primitive: D Flip-Flop with Clock Enable and Asynchronous Preset
FDPE_1	Primitive: D Flip-Flop with Negative-Edge Clock, Clock Enable, and Asynchronous Preset
FDR	Primitive: D Flip-Flop with Synchronous Reset
FDR_1	Primitive: D Flip-Flop with Negative-Edge Clock and Synchronous Reset
FDRE	Primitive: D Flip-Flop with Clock Enable and Synchronous Reset
FDRE_1	Primitive: D Flip-Flop with Negative-Clock Edge, Clock Enable, and Synchronous Reset
FDS	Primitive: D Flip-Flop with Synchronous Set
FDS_1	Primitive: D Flip-Flop with Negative-Edge Clock and Synchronous Set
FDSE	Primitive: D Flip-Flop with Clock Enable and Synchronous Set
FDSE_1	Primitive: D Flip-Flop with Negative-Edge Clock, Clock Enable, and Synchronous Set
FJKC	Macro: J-K Flip-Flop with Asynchronous Clear
FJKCE	Macro: J-K Flip-Flop with Clock Enable and Asynchronous Clear
FJKP	Macro: J-K Flip-Flop with Asynchronous Preset
FJKPE	Macro: J-K Flip-Flop with Clock Enable and Asynchronous Preset
FTC	Macro: Toggle Flip-Flop with Asynchronous Clear

Design Element	Description
FTCE	Macro: Toggle Flip-Flop with Clock Enable and Asynchronous Clear
FTCLE	Macro: Toggle/Loadable Flip-Flop with Clock Enable and Asynchronous Clear
FTCLEX	Macro: Toggle/Loadable Flip-Flop with Clock Enable and Asynchronous Clear
FTP	Macro: Toggle Flip-Flop with Asynchronous Preset
FTPE	Macro: Toggle Flip-Flop with Clock Enable and Asynchronous Preset
FTPLE	Macro: Toggle/Loadable Flip-Flop with Clock Enable and Asynchronous Preset

### General

Design Element	Description
BSCAN_SPARTAN6	Primitive: Spartan®-6 JTAG Boundary Scan Logic Control Circuit
DNA_PORT	Primitive: Device DNA Data Access Port
GND	Primitive: Ground-Connection Signal Tag
ICAP_SPARTAN6	Primitive: Internal Configuration Access Port
KEEPER	Primitive: KEEPER Symbol
POST_CRC_INTERNAL	Primitive: Post-configuration CRC error detection
PULLDOWN	Primitive: Resistor to GND for Input Pads, Open-Drain, and 3-State Outputs
PULLUP	Primitive: Resistor to VCC for Input PADS, Open-Drain, and 3-State Outputs
STARTUP_SPARTAN6	Primitive: Spartan®-6 Global Set/Reset, Global 3-State and Configuration Start-Up Clock Interface
SUSPEND_SYNC	Primitive: Suspend Mode Access
VCC	Primitive: VCC-Connection Signal Tag

### Input/Output Functions

Design Element	Description
IODELAY2	Primitive: Input and Output Fixed or Variable Delay Element
IODRP2	Primitive: I/O Control Port
ISERDES2	Primitive: Input SERIAL/DESerializer.
OSERDES2	Primitive: Dedicated IOB Output Serializer

## IO

Design Element	Description
IBUF	Primitive: Input Buffer
IBUFDS	Primitive: Differential Signaling Input Buffer
IBUFDS_DIFF_OUT	Primitive: Signaling Input Buffer with Differential Output
IBUFDS_DLY_ADJ	Primitive: Dynamically Adjustable Differential Input Delay Buffer
IBUF16	Macro: 16-Bit Input Buffer
IBUF4	Macro: 4-Bit Input Buffer
IBUF8	Macro: 8-Bit Input Buffer
IBUFG	Primitive: Dedicated Input Clock Buffer
IBUFGDS	Primitive: Differential Signaling Dedicated Input Clock Buffer and Optional Delay
IBUFGDS_DIFF_OUT	Primitive: Differential Signaling Input Buffer with Differential Output
IOBUF	Primitive: Bi-Directional Buffer
IOBUFDS	Primitive: 3-State Differential Signaling I/O Buffer with Active Low Output Enable
OBUF	Primitive: Output Buffer
OBUF16	Macro: 16-Bit Output Buffer
OBUF8	Macro: 8-Bit Output Buffer
OBUF4	Macro: 4-Bit Output Buffer
OBUFDS	Primitive: Differential Signaling Output Buffer
OBUFT	Primitive: 3-State Output Buffer with Active Low Output Enable
OBUFT4	Macro: 4-Bit 3-State Output Buffers with Active-Low Output Enable
OBUFT8	Macro: 8-Bit 3-State Output Buffers with Active-Low Output Enable
OBUFT16	Macro: 16-Bit 3-State Output Buffer with Active Low Output Enable
OBUFTDS	Primitive: 3-State Output Buffer with Differential Signaling, Active-Low Output Enable

## IO FlipFlop

Design Element	Description
IFD	Macro: Input D Flip-Flop
IFD_1	Macro: Input D Flip-Flop with Inverted Clock (Asynchronous Preset)
IFD16	Macro: 16-Bit Input D Flip-Flop
IFD4	Macro: 4-Bit Input D Flip-Flop
IFD8	Macro: 8-Bit Input D Flip-Flop
IFDI	Macro: Input D Flip-Flop (Asynchronous Preset)



Design Element	Description
IFDI_1	Macro: Input D Flip-Flop with Inverted Clock (Asynchronous Preset)
IFDX	Macro: Input D Flip-Flop with Clock Enable
IFDX_1	Macro: Input D Flip-Flop with Inverted Clock and Clock Enable
IFDX16	Macro: 16-Bit Input D Flip-Flops with Clock Enable
IFDX4	Macro: 4-Bit Input D Flip-Flop with Clock Enable
IFDX8	Macro: 8-Bit Input D Flip-Flop with Clock Enable
IFDXI	Macro: Input D Flip-Flop with Clock Enable (Asynchronous Preset)
IFDXI_1	Macro: Input D Flip-Flop with Inverted Clock and Clock Enable (Asynchronous Preset)
OFD	Macro: Output D Flip-Flop
OFD_1	Macro: Output D Flip-Flop with Inverted Clock
OFD16	Macro: 16-Bit Output D Flip-Flop
OFD4	Macro: 4-Bit Output D Flip-Flop
OFD8	Macro: 8-Bit Output D Flip-Flop
OFDE	Macro: D Flip-Flop with Active-High Enable Output Buffers
OFDE_1	Macro: D Flip-Flop with Active-High Enable Output Buffer and Inverted Clock
OFDE16	Macro: 16-Bit D Flip-Flop with Active-High Enable Output Buffers
OFDE4	Macro: 4-Bit D Flip-Flop with Active-High Enable Output Buffers
OFDE8	Macro: 8-Bit D Flip-Flop with Active-High Enable Output Buffers
OFDI	Macro: Output D Flip-Flop (Asynchronous Preset)
OFDI_1	Macro: Output D Flip-Flop with Inverted Clock (Asynchronous Preset)
OFDT	Macro: D Flip-Flop with Active-Low 3-State Output Buffer
OFDT_1	Macro: D Flip-Flop with Active-Low 3-State Output Buffer and Inverted Clock
OFDT16	Macro: 16-Bit D Flip-Flop with Active-Low 3-State Output Buffers
OFDT4	Macro: 4-Bit D Flip-Flop with Active-Low 3-State Output Buffers
OFDT8	Macro: 8-Bit D Flip-Flop with Active-Low 3-State Output Buffers
OFDX	Macro: Output D Flip-Flop with Clock Enable
OFDX_1	Macro: Output D Flip-Flop with Inverted Clock and Clock Enable
OFDX16	Macro: 16-Bit Output D Flip-Flop with Clock Enable
OFDX4	Macro: 4-Bit Output D Flip-Flop with Clock Enable

Design Element	Description
OFDX8	Macro: 8-Bit Output D Flip-Flop with Clock Enable
OFDXI	Macro: Output D Flip-Flop with Clock Enable (Asynchronous Preset)
OFDXI_1	Macro: Output D Flip-Flop with Inverted Clock and Clock Enable (Asynchronous Preset)

### IO Latch

Design Element	Description
ILD	Macro: Transparent Input Data Latch
ILD_1	Macro: Transparent Input Data Latch with Inverted Gate
ILD16	Macro: Transparent Input Data Latch
ILD4	Macro: Transparent Input Data Latch
ILD8	Macro: Transparent Input Data Latch
ILDI	Macro: Transparent Input Data Latch (Asynchronous Preset)
ILDI_1	Macro: Transparent Input Data Latch with Inverted Gate (Asynchronous Preset)
ILDY	Macro: Transparent Input Data Latch
ILDY_1	Macro: Transparent Input Data Latch with Inverted Gate
ILDY16	Macro: Transparent Input Data Latch
ILDY4	Macro: Transparent Input Data Latch
ILDY8	Macro: Transparent Input Data Latch
ILDYI	Macro: Transparent Input Data Latch (Asynchronous Preset)
ILDYI_1	Macro: Transparent Input Data Latch with Inverted Gate (Asynchronous Preset)

### Latch

Design Element	Description
LD	Primitive: Transparent Data Latch
LD_1	Primitive: Transparent Data Latch with Inverted Gate
LD16	Macro: Multiple Transparent Data Latch
LD4	Macro: Multiple Transparent Data Latch
LD8	Macro: Multiple Transparent Data Latch
LD16CE	Macro: Transparent Data Latch with Asynchronous Clear and Gate Enable
LD4CE	Macro: Transparent Data Latch with Asynchronous Clear and Gate Enable
LD8CE	Macro: Transparent Data Latch with Asynchronous Clear and Gate Enable
LDC	Primitive: Transparent Data Latch with Asynchronous Clear

Design Element	Description
LDC_1	Primitive: Transparent Data Latch with Asynchronous Clear and Inverted Gate
LDCE	Primitive: Transparent Data Latch with Asynchronous Clear and Gate Enable
LDCE_1	Primitive: Transparent Data Latch with Asynchronous Clear, Gate Enable, and Inverted Gate
LDE	Primitive: Transparent Data Latch with Gate Enable
LDE_1	Primitive: Transparent Data Latch with Gate Enable and Inverted Gate
LDP	Primitive: Transparent Data Latch with Asynchronous Preset
LDP_1	Primitive: Transparent Data Latch with Asynchronous Preset and Inverted Gate
LDPE	Primitive: Transparent Data Latch with Asynchronous Preset and Gate Enable
LDPE_1	Primitive: Transparent Data Latch with Asynchronous Preset, Gate Enable, and Inverted Gate

### Logic

Design Element	Description
AND12	Macro: 12- Input AND Gate with Non-Inverted Inputs
AND16	16- Input AND Gate with Non-Inverted Inputs
AND2	Primitive: 2-Input AND Gate with Non-Inverted Inputs
AND2B1	Primitive: 2-Input AND Gate with 1 Inverted and 1 Non-Inverted Inputs
AND2B1L	Primitive: Two input AND gate implemented in place of a Slice Latch
AND2B2	Primitive: 2-Input AND Gate with Inverted Inputs
AND3	Primitive: 3-Input AND Gate with Non-Inverted Inputs
AND3B1	Primitive: 3-Input AND Gate with 1 Inverted and 2 Non-Inverted Inputs
AND3B2	Primitive: 3-Input AND Gate with 2 Inverted and 1 Non-Inverted Inputs
AND3B3	Primitive: 3-Input AND Gate with Inverted Inputs
AND4	Primitive: 4-Input AND Gate with Non-Inverted Inputs
AND4B1	Primitive: 4-Input AND Gate with 1 Inverted and 3 Non-Inverted Inputs
AND4B2	Primitive: 4-Input AND Gate with 2 Inverted and 2 Non-Inverted Inputs
AND4B3	Primitive: 4-Input AND Gate with 3 Inverted and 1 Non-Inverted Inputs
AND4B4	Primitive: 4-Input AND Gate with Inverted Inputs
AND5	Primitive: 5-Input AND Gate with Non-Inverted Inputs

Design Element	Description
AND5B1	Primitive: 5-Input AND Gate with 1 Inverted and 4 Non-Inverted Inputs
AND5B2	Primitive: 5-Input AND Gate with 2 Inverted and 3 Non-Inverted Inputs
AND5B3	Primitive: 5-Input AND Gate with 3 Inverted and 2 Non-Inverted Inputs
AND5B4	Primitive: 5-Input AND Gate with 4 Inverted and 1 Non-Inverted Inputs
AND5B5	Primitive: 5-Input AND Gate with Inverted Inputs
AND6	Macro: 6-Input AND Gate with Non-Inverted Inputs
AND7	Macro: 7-Input AND Gate with Non-Inverted Inputs
AND8	Macro: 8-Input AND Gate with Non-Inverted Inputs
AND9	Macro: 9-Input AND Gate with Non-Inverted Inputs
INV	Primitive: Inverter
INV16	Macro: 16 Inverters
INV4	Macro: Four Inverters
INV8	Macro: Eight Inverters
MULT_AND	Primitive: Fast Multiplier AND
NAND12	Macro: 12- Input NAND Gate with Non-Inverted Inputs
NAND16	Macro: 16- Input NAND Gate with Non-Inverted Inputs
NAND2	Primitive: 2-Input NAND Gate with Non-Inverted Inputs
NAND2B1	Primitive: 2-Input NAND Gate with 1 Inverted and 1 Non-Inverted Inputs
NAND2B2	Primitive: 2-Input NAND Gate with Inverted Inputs
NAND3	Primitive: 3-Input NAND Gate with Non-Inverted Inputs
NAND3B1	Primitive: 3-Input NAND Gate with 1 Inverted and 2 Non-Inverted Inputs
NAND3B2	Primitive: 3-Input NAND Gate with 2 Inverted and 1 Non-Inverted Inputs
NAND3B3	Primitive: 3-Input NAND Gate with Inverted Inputs
NAND4	Primitive: 4-Input NAND Gate with Non-Inverted Inputs
NAND4B1	Primitive: 4-Input NAND Gate with 1 Inverted and 3 Non-Inverted Inputs
NAND4B2	Primitive: 4-Input NAND Gate with 2 Inverted and 2 Non-Inverted Inputs
NAND4B3	Primitive: 4-Input NAND Gate with 3 Inverted and 1 Non-Inverted Inputs
NAND4B4	Primitive: 4-Input NAND Gate with Inverted Inputs
NAND5	Primitive: 5-Input NAND Gate with Non-Inverted Inputs
NAND5B1	Primitive: 5-Input NAND Gate with 1 Inverted and 4 Non-Inverted Inputs
NAND5B2	Primitive: 5-Input NAND Gate with 2 Inverted and 3 Non-Inverted Inputs

Design Element	Description
NAND5B3	Primitive: 5-Input NAND Gate with 3 Inverted and 2 Non-Inverted Inputs
NAND5B4	Primitive: 5-Input NAND Gate with 4 Inverted and 1 Non-Inverted Inputs
NAND5B5	Primitive: 5-Input NAND Gate with Inverted Inputs
NAND6	Macro: 6-Input NAND Gate with Non-Inverted Inputs
NAND7	Macro: 7-Input NAND Gate with Non-Inverted Inputs
NAND8	Macro: 8-Input NAND Gate with Non-Inverted Inputs
NAND9	Macro: 9-Input NAND Gate with Non-Inverted Inputs
NOR12	Macro: 12-Input NOR Gate with Non-Inverted Inputs
NOR16	Macro: 16-Input NOR Gate with Non-Inverted Inputs
NOR2	Primitive: 2-Input NOR Gate with Non-Inverted Inputs
NOR2B1	Primitive: 2-Input NOR Gate with 1 Inverted and 1 Non-Inverted Inputs
NOR2B2	Primitive: 2-Input NOR Gate with Inverted Inputs
NOR3	Primitive: 3-Input NOR Gate with Non-Inverted Inputs
NOR3B1	Primitive: 3-Input NOR Gate with 1 Inverted and 2 Non-Inverted Inputs
NOR3B2	Primitive: 3-Input NOR Gate with 2 Inverted and 1 Non-Inverted Inputs
NOR3B3	Primitive: 3-Input NOR Gate with Inverted Inputs
NOR4	Primitive: 4-Input NOR Gate with Non-Inverted Inputs
NOR4B1	Primitive: 4-Input NOR Gate with 1 Inverted and 3 Non-Inverted Inputs
NOR4B2	Primitive: 4-Input NOR Gate with 2 Inverted and 2 Non-Inverted Inputs
NOR4B3	Primitive: 4-Input NOR Gate with 3 Inverted and 1 Non-Inverted Inputs
NOR4B4	Primitive: 4-Input NOR Gate with Inverted Inputs
NOR5	Primitive: 5-Input NOR Gate with Non-Inverted Inputs
NOR5B1	Primitive: 5-Input NOR Gate with 1 Inverted and 4 Non-Inverted Inputs
NOR5B2	Primitive: 5-Input NOR Gate with 2 Inverted and 3 Non-Inverted Inputs
NOR5B3	Primitive: 5-Input NOR Gate with 3 Inverted and 2 Non-Inverted Inputs
NOR5B4	Primitive: 5-Input NOR Gate with 4 Inverted and 1 Non-Inverted Inputs
NOR5B5	Primitive: 5-Input NOR Gate with Inverted Inputs
NOR6	Macro: 6-Input NOR Gate with Non-Inverted Inputs
NOR7	Macro: 7-Input NOR Gate with Non-Inverted Inputs
NOR8	Macro: 8-Input NOR Gate with Non-Inverted Inputs
NOR9	Macro: 9-Input NOR Gate with Non-Inverted Inputs

Design Element	Description
OR12	Macro: 12-Input OR Gate with Non-Inverted Inputs
OR16	Macro: 16-Input OR Gate with Non-Inverted Inputs
OR2	Primitive: 2-Input OR Gate with Non-Inverted Inputs
OR2L	Primitive: Two input OR gate implemented in place of a Slice Latch
OR2B1	Primitive: 2-Input OR Gate with 1 Inverted and 1 Non-Inverted Inputs
OR2B2	Primitive: 2-Input OR Gate with Inverted Inputs
OR3	Primitive: 3-Input OR Gate with Non-Inverted Inputs
OR3B1	Primitive: 3-Input OR Gate with 1 Inverted and 2 Non-Inverted Inputs
OR3B2	Primitive: 3-Input OR Gate with 2 Inverted and 1 Non-Inverted Inputs
OR3B3	Primitive: 3-Input OR Gate with Inverted Inputs
OR4	Primitive: 4-Input OR Gate with Non-Inverted Inputs
OR4B1	Primitive: 4-Input OR Gate with 1 Inverted and 3 Non-Inverted Inputs
OR4B2	Primitive: 4-Input OR Gate with 2 Inverted and 2 Non-Inverted Inputs
OR4B3	Primitive: 4-Input OR Gate with 3 Inverted and 1 Non-Inverted Inputs
OR4B4	Primitive: 4-Input OR Gate with Inverted Inputs
OR5	Primitive: 5-Input OR Gate with Non-Inverted Inputs
OR5B1	Primitive: 5-Input OR Gate with 1 Inverted and 4 Non-Inverted Inputs
OR5B2	Primitive: 5-Input OR Gate with 2 Inverted and 3 Non-Inverted Inputs
OR5B3	Primitive: 5-Input OR Gate with 3 Inverted and 2 Non-Inverted Inputs
OR5B4	Primitive: 5-Input OR Gate with 4 Inverted and 1 Non-Inverted Inputs
OR5B5	Primitive: 5-Input OR Gate with Inverted Inputs
OR6	Macro: 6-Input OR Gate with Non-Inverted Inputs
OR7	Macro: 7-Input OR Gate with Non-Inverted Inputs
OR8	Macro: 8-Input OR Gate with Non-Inverted Inputs
OR9	Macro: 9-Input OR Gate with Non-Inverted Inputs
SOP3	Macro: 3-Input Sum of Products
SOP3B1A	Macro: 3-Input Sum of Products with One Inverted Input (Option A)
SOP3B1B	Macro: 3-Input Sum of Products with One Inverted Input (Option B)
SOP3B2A	Macro: 3-Input Sum of Products with Two Inverted Inputs (Option A)

Design Element	Description
SOP3B2B	Macro: 3-Input Sum of Products with Two Inverted Inputs (Option B)
SOP3B3	Macro: 3-Input Sum of Products with Inverted Inputs
SOP4	Macro: 4-Input Sum of Products
SOP4B1	Macro: 4-Input Sum of Products with One Inverted Input
SOP4B2A	Macro: 4-Input Sum of Products with Two Inverted Inputs (Option A)
SOP4B2B	Macro: 4-Input Sum of Products with Two Inverted Inputs (Option B)
SOP4B3	Macro: 4-Input Sum of Products with Three Inverted Inputs
SOP4B4	Macro: 4-Input Sum of Products with Inverted Inputs
XNOR2	Primitive: 2-Input XNOR Gate with Non-Inverted Inputs
XNOR3	Primitive: 3-Input XNOR Gate with Non-Inverted Inputs
XNOR4	Primitive: 4-Input XNOR Gate with Non-Inverted Inputs
XNOR5	Primitive: 5-Input XNOR Gate with Non-Inverted Inputs
XNOR6	Macro: 6-Input XNOR Gate with Non-Inverted Inputs
XNOR7	Macro: 7-Input XNOR Gate with Non-Inverted Inputs
XNOR8	Macro: 8-Input XNOR Gate with Non-Inverted Inputs
XNOR9	Macro: 9-Input XNOR Gate with Non-Inverted Inputs
XOR2	Primitive: 2-Input XOR Gate with Non-Inverted Inputs
XOR3	Primitive: 3-Input XOR Gate with Non-Inverted Inputs
XOR4	Primitive: 4-Input XOR Gate with Non-Inverted Inputs
XOR5	Primitive: 5-Input XOR Gate with Non-Inverted Inputs
XOR6	Macro: 6-Input XOR Gate with Non-Inverted Inputs
XOR7	Macro: 7-Input XOR Gate with Non-Inverted Inputs
XOR8	Macro: 8-Input XOR Gate with Non-Inverted Inputs
XOR9	Macro: 9-Input XOR Gate with Non-Inverted Inputs

### LUT

Design Element	Description
CFGLUT5	Primitive: 5-input Dynamically Reconfigurable Look-Up Table (LUT)
LUT1	Macro: 1-Bit Look-Up Table with General Output
LUT1_D	Macro: 1-Bit Look-Up Table with Dual Output
LUT1_L	Macro: 1-Bit Look-Up Table with Local Output
LUT2	Macro: 2-Bit Look-Up Table with General Output
LUT2_D	Macro: 2-Bit Look-Up Table with Dual Output
LUT2_L	Macro: 2-Bit Look-Up Table with Local Output
LUT3	Macro: 3-Bit Look-Up Table with General Output

Design Element	Description
LUT3_D	Macro: 3-Bit Look-Up Table with Dual Output
LUT3_L	Macro: 3-Bit Look-Up Table with Local Output
LUT4	Macro: 4-Bit Look-Up-Table with General Output
LUT4_D	Macro: 4-Bit Look-Up Table with Dual Output
LUT4_L	Macro: 4-Bit Look-Up Table with Local Output
LUT5	Primitive: 5-Input Lookup Table with General Output
LUT5_D	Primitive: 5-Input Lookup Table with General and Local Outputs
LUT5_L	Primitive: 5-Input Lookup Table with Local Output
LUT6	Primitive: 6-Input Lookup Table with General Output
LUT6_D	Primitive: 6-Input Lookup Table with General and Local Outputs
LUT6_L	Primitive: 6-Input Lookup Table with Local Output
LUT6_2	Primitive: Six-input, 2-output, Look-Up Table

### Memory

Design Element	Description
RAM16X1D	Primitive: 16-Deep by 1-Wide Static Dual Port Synchronous RAM
RAM16X1D_1	Primitive: 16-Deep by 1-Wide Static Dual Port Synchronous RAM with Negative-Edge Clock
RAM16X1S	Primitive: 16-Deep by 1-Wide Static Synchronous RAM
RAM16X1S_1	Primitive: 16-Deep by 1-Wide Static Synchronous RAM with Negative-Edge Clock
RAM16X2S	Primitive: 16-Deep by 2-Wide Static Synchronous RAM
RAM16X4S	Primitive: 16-Deep by 4-Wide Static Synchronous RAM
RAM16X8S	Primitive: 16-Deep by 8-Wide Static Synchronous RAM
RAM32M	Primitive: 32-Deep by 8-bit Wide Multi Port Random Access Memory (Select RAM)
RAM32X1D	Primitive: 32-Deep by 1-Wide Static Dual Port Synchronous RAM
RAM32X1S	Primitive: 32-Deep by 1-Wide Static Synchronous RAM
RAM32X1S_1	Primitive: 32-Deep by 1-Wide Static Synchronous RAM with Negative-Edge Clock
RAM32X2S	Primitive: 32-Deep by 2-Wide Static Synchronous RAM
RAM32X4S	Primitive: 32-Deep by 4-Wide Static Synchronous RAM
RAM32X8S	Primitive: 32-Deep by 8-Wide Static Synchronous RAM
RAM64M	Primitive: 64-Deep by 4-bit Wide Multi Port Random Access Memory (Select RAM)
RAM64X1D	Primitive: 64-Deep by 1-Wide Dual Port Static Synchronous RAM
RAM64X1S	Primitive: 64-Deep by 1-Wide Static Synchronous RAM



Design Element	Description
RAM64X1S_1	Primitive: 64-Deep by 1-Wide Static Synchronous RAM with Negative-Edge Clock
RAM64X2S	Primitive: 64-Deep by 2-Wide Static Synchronous RAM
RAM128X1D	Primitive: 128-Deep by 1-Wide Dual Port Random Access Memory (Select RAM)
RAM256X1S	Primitive: 256-Deep by 1-Wide Random Access Memory (Select RAM)
RAMB8BWVER	Primitive: 8K-bit Data and 1K-bit Parity Configurable Synchronous Dual Port Block RAM with Optional Output Registers
RAMB16BWVER	Primitive: 16K-bit Data and 2K-bit Parity Configurable Synchronous Dual Port Block RAM with Optional Output Registers
ROM32X1	Primitive: 32-Deep by 1-Wide ROM
ROM64X1	Primitive: 64-Deep by 1-Wide ROM
ROM128X1	Primitive: 128-Deep by 1-Wide ROM
ROM256X1	Primitive: 256-Deep by 1-Wide ROM

### Mux

Design Element	Description
M16_1E	Macro: 16-to-1 Multiplexer with Enable
M2_1	Macro: 2-to-1 Multiplexer
M2_1B1	Macro: 2-to-1 Multiplexer with D0 Inverted
M2_1B2	Macro: 2-to-1 Multiplexer with D0 and D1 Inverted
M2_1E	Macro: 2-to-1 Multiplexer with Enable
M4_1E	Macro: 4-to-1 Multiplexer with Enable
M8_1E	Macro: 8-to-1 Multiplexer with Enable
MUXF5	Primitive: 2-to-1 Look-Up Table Multiplexer with General Output
MUXF5_D	Primitive: 2-to-1 Look-Up Table Multiplexer with Dual Output
MUXF5_L	Primitive: 2-to-1 Look-Up Table Multiplexer with Local Output
MUXF6	Primitive: 2-to-1 Look-Up Table Multiplexer with General Output
MUXF6_D	Primitive: 2-to-1 Look-Up Table Multiplexer with Dual Output
MUXF6_L	Primitive: 2-to-1 Look-Up Table Multiplexer with Local Output
MUXF7	Primitive: 2-to-1 Look-Up Table Multiplexer with General Output
MUXF7_D	Primitive: 2-to-1 Look-Up Table Multiplexer with Dual Output

Design Element	Description
<a href="#">MUXF7_L</a>	Primitive: 2-to-1 look-up table Multiplexer with Local Output
<a href="#">MUXF8</a>	Primitive: 2-to-1 Look-Up Table Multiplexer with General Output
<a href="#">MUXF8_D</a>	Primitive: 2-to-1 Look-Up Table Multiplexer with Dual Output
<a href="#">MUXF8_L</a>	Primitive: 2-to-1 Look-Up Table Multiplexer with Local Output

### Shift Register

Design Element	Description
<a href="#">SR16CE</a>	Macro: 16-Bit Serial-In Parallel-Out Shift Register with Clock Enable and Asynchronous Clear
<a href="#">SR16CLE</a>	Macro: 16-Bit Loadable Serial/Parallel-In Parallel-Out Shift Register with Clock Enable and Asynchronous Clear
<a href="#">SR16CLED</a>	Macro: 16-Bit Shift Register with Clock Enable and Asynchronous Clear
<a href="#">SR16RE</a>	Macro: 16-Bit Serial-In Parallel-Out Shift Register with Clock Enable and Synchronous Reset
<a href="#">SR16RLE</a>	Macro: 16-Bit Loadable Serial/Parallel-In Parallel-Out Shift Register with Clock Enable and Synchronous Reset
<a href="#">SR16RLED</a>	Macro: 16-Bit Shift Register with Clock Enable and Synchronous Reset
<a href="#">SR4CE</a>	Macro: 4-Bit Serial-In Parallel-Out Shift Register with Clock Enable and Asynchronous Clear
<a href="#">SR4CLE</a>	Macro: 4-Bit Loadable Serial/Parallel-In Parallel-Out Shift Register with Clock Enable and Asynchronous Clear
<a href="#">SR4CLED</a>	Macro: 4-Bit Shift Register with Clock Enable and Asynchronous Clear
<a href="#">SR4RE</a>	Macro: 4-Bit Serial-In Parallel-Out Shift Register with Clock Enable and Synchronous Reset
<a href="#">SR4RLE</a>	Macro: 4-Bit Loadable Serial/Parallel-In Parallel-Out Shift Register with Clock Enable and Synchronous Reset
<a href="#">SR4RLED</a>	Macro: 4-Bit Shift Register with Clock Enable and Synchronous Reset
<a href="#">SR8CE</a>	Macro: 8-Bit Serial-In Parallel-Out Shift Register with Clock Enable and Asynchronous Clear
<a href="#">SR8CLE</a>	Macro: 8-Bit Loadable Serial/Parallel-In Parallel-Out Shift Register with Clock Enable and Asynchronous Clear
<a href="#">SR8CLED</a>	Macro: 8-Bit Shift Register with Clock Enable and Asynchronous Clear
<a href="#">SR8RE</a>	Macro: 8-Bit Serial-In Parallel-Out Shift Register with Clock Enable and Synchronous Reset
<a href="#">SR8RLE</a>	Macro: 8-Bit Loadable Serial/Parallel-In Parallel-Out Shift Register with Clock Enable and Synchronous Reset
<a href="#">SR8RLED</a>	Macro: 8-Bit Shift Register with Clock Enable and Synchronous Reset

Design Element	Description
<a href="#">SRL16</a>	Primitive: 16-Bit Shift Register Look-Up Table (LUT)
<a href="#">SRL16_1</a>	Primitive: 16-Bit Shift Register Look-Up Table (LUT) with Negative-Edge Clock
<a href="#">SRL16E</a>	Primitive: 16-Bit Shift Register Look-Up Table (LUT) with Clock Enable
<a href="#">SRL16E_1</a>	Primitive: 16-Bit Shift Register Look-Up Table (LUT) with Negative-Edge Clock and Clock Enable
<a href="#">SRLC16</a>	Primitive: 16-Bit Shift Register Look-Up Table (LUT) with Carry
<a href="#">SRLC16_1</a>	Primitive: 16-Bit Shift Register Look-Up Table (LUT) with Carry and Negative-Edge Clock
<a href="#">SRLC16E</a>	Primitive: 16-Bit Shift Register Look-Up Table (LUT) with Carry and Clock Enable
<a href="#">SRLC16E_1</a>	Primitive: 16-Bit Shift Register Look-Up Table (LUT) with Carry, Negative-Edge Clock, and Clock Enable
<a href="#">SRLC32E</a>	Primitive: 32 Clock Cycle, Variable Length Shift Register Look-Up Table (LUT) with Clock Enable

### Shifter

Design Element	Description
<a href="#">BRLSHFT4</a>	Macro: 4-Bit Barrel Shifter
<a href="#">BRLSHFT8</a>	Macro: 8-Bit Barrel Shifter



## About Design Elements

---

This section describes the design elements that can be used with Spartan®-6 devices. The design elements are organized alphabetically.

The following information is provided for each design element, where applicable:

- Name of element
- Brief description
- Schematic symbol (if any)
- Logic Table (if any)
- Port Descriptions (if any)
- Design Entry Method
- Available Attributes (if any)
- For more information

You can find examples of VHDL and Verilog instantiation code in the ISE software (in the main menu, select **Edit > Language Templates** or in the *Libraries Guide for HDL Designs* for this architecture.

## ACC16

### Macro: 16-Bit Loadable Cascadable Accumulator with Carry-In, Carry-Out, and Synchronous Reset

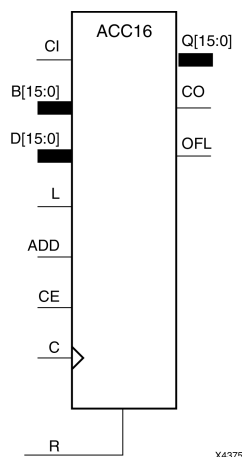

## Introduction

This design element can add or subtract a 16-bit unsigned-binary, respectively or two's-complement word to or from the contents of a 16-bit data register and store the results in the register. The register can be loaded with the 16-bit word.

When the load input (L) is High, CE is ignored and the data on the D inputs is loaded into the register during the Low-to-High clock (C) transition. ACC16 loads the data on inputs D15 : D0 into the 16-bit register.

This design element operates on either 16-bit unsigned binary numbers or 16-bit two's-complement numbers. If the inputs are interpreted as unsigned binary, the result can be interpreted as unsigned binary. If the inputs are interpreted as two's complement, the output can be interpreted as two's complement. The only functional difference between an unsigned binary operation and a two's-complement operation is how they determine when "overflow" occurs. Unsigned binary uses carry-out (CO), while two's complement uses OFL to determine when "overflow" occurs.

- For unsigned binary operation, ACC16 can represent numbers between 0 and 15, inclusive. In add mode, CO is active (High) when the sum exceeds the bounds of the adder/subtractor. In subtract mode, CO is an active-Low borrow-out and goes Low when the difference exceeds the bounds. The carry-out (CO) is not registered synchronously with the data outputs. CO always reflects the accumulation of the B inputs (B15 : B0 for ACC16). This allows the cascading of ACC16s by connecting CO of one stage to CI of the next stage. An unsigned binary "overflow" that is always active-High can be generated by gating the ADD signal and CO as follows:

```
unsigned overflow = CO XOR ADD
```

Ignore OFL in unsigned binary operation.

- For two's-complement operation, ACC16 represents numbers between -8 and +7, inclusive. If an addition or subtraction operation result exceeds this range, the OFL output goes High. The overflow (OFL) is not registered synchronously with the data outputs. OFL always reflects the accumulation of the B inputs (B15 : B0 for ACC16) and the contents of the register, which allows cascading of ACC4s by connecting OFL of one stage to CI of the next stage.

Ignore CO in two's-complement operation.

The synchronous reset (R) has priority over all other inputs, and when set to High, causes all outputs to go to logic level zero during the Low-to-High clock (C) transition. Clock (C) transitions are ignored when clock enable (CE) is Low.

This design element is asynchronously cleared, outputs Low, when power is applied. For FPGA devices, power-on conditions are simulated when global set/reset (GSR) is active. GSR defaults to active-High but can be inverted by adding an inverter in front of the GSR input of the appropriate `STARTUP_architecture` symbol.

## Logic Table

Input						Output
R	L	CE	ADD	D	C	Q
1	x	x	x	x	↑	0
0	1	x	x	Dn	↑	Dn
0	0	1	1	x	↑	Q0+Bn+CI
0	0	1	0	x	↑	Q0-Bn-CI
0	0	0	x	x	↑	No Change
Q0: Previous value of Q Bn: Value of Data input B CI: Value of input CI						

## Design Entry Method

This design element is only for use in schematics.

## For More Information

See the [Spartan-6 FPGA User Documentation \(User Guides and Data Sheets\)](#).

## ACC4

### Macro: 4-Bit Loadable Cascadable Accumulator with Carry-In, Carry-Out, and Synchronous Reset

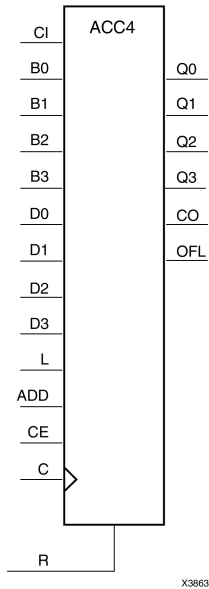

## Introduction

This design element can add or subtract a 4-bit unsigned-binary, respectively or two's-complement word to or from the contents of a 4-bit data register and store the results in the register. The register can be loaded with the 4-bit word.

When the load input (L) is High, CE is ignored and the data on the D inputs is loaded into the register during the Low-to-High clock (C) transition. ACC4 loads the data on inputs D3 : D0 into the 4-bit register.

This design element operates on either 4-bit unsigned binary numbers or 4-bit two's-complement numbers. If the inputs are interpreted as unsigned binary, the result can be interpreted as unsigned binary. If the inputs are interpreted as two's complement, the output can be interpreted as two's complement. The only functional difference between an unsigned binary operation and a two's-complement operation is how they determine when "overflow" occurs. Unsigned binary uses carry-out (CO), while two's complement uses OFL to determine when "overflow" occurs.

- For unsigned binary operation, ACC4 can represent numbers between 0 and 15, inclusive. In add mode, CO is active (High) when the sum exceeds the bounds of the adder/subtractor. In subtract mode, CO is an active-Low borrow-out and goes Low when the difference exceeds the bounds. The carry-out (CO) is not registered synchronously with the data outputs. CO always reflects the accumulation of the B inputs (B3 : B0 for ACC4). This allows the cascading of ACC4s by connecting CO of one stage to CI of the next stage. An unsigned binary "overflow" that is always active-High can be generated by gating the ADD signal and CO as follows:

```
unsigned overflow = CO XOR ADD
```

Ignore OFL in unsigned binary operation.

- For two's-complement operation, ACC4 represents numbers between -8 and +7, inclusive. If an addition or subtraction operation result exceeds this range, the OFL output goes High. The overflow (OFL) is not registered synchronously with the data outputs. OFL always reflects the accumulation of the B inputs (B3 : B0 for ACC4) and the contents of the register, which allows cascading of ACC4s by connecting OFL of one stage to CI of the next stage.

Ignore CO in two's-complement operation.



The synchronous reset (R) has priority over all other inputs, and when set to High, causes all outputs to go to logic level zero during the Low-to-High clock (C) transition. Clock (C) transitions are ignored when clock enable (CE) is Low.

This design element is asynchronously cleared, outputs Low, when power is applied. For FPGA devices, power-on conditions are simulated when global set/reset (GSR) is active. GSR defaults to active-High but can be inverted by adding an inverter in front of the GSR input of the appropriate STARTUP\_architecture symbol.

### Logic Table

Input						Output
R	L	CE	ADD	D	C	Q
1	x	x	x	x	↑	0
0	1	x	x	Dn	↑	Dn
0	0	1	1	x	↑	Q0+Bn+CI
0	0	1	0	x	↑	Q0-Bn-CI
0	0	0	x	x	↑	No Change
Q0: Previous value of Q Bn: Value of Data input B CI: Value of input CI						

### Design Entry Method

This design element is only for use in schematics.

### For More Information

See the [Spartan-6 FPGA User Documentation \(User Guides and Data Sheets\)](#).

## ACC8

### Macro: 8-Bit Loadable Cascadable Accumulator with Carry-In, Carry-Out, and Synchronous Reset

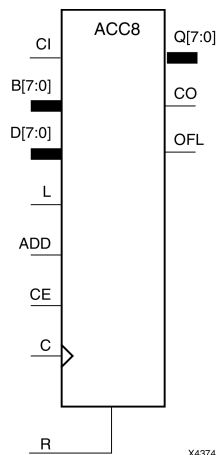

## Introduction

This design element can add or subtract a 8-bit unsigned-binary, respectively or two's-complement word to or from the contents of a 8-bit data register and store the results in the register. The register can be loaded with the 8-bit word.

When the load input (L) is High, CE is ignored and the data on the D inputs is loaded into the register during the Low-to-High clock (C) transition. ACC8 loads the data on inputs D7 : D0 into the 8-bit register.

This design element operates on either 8-bit unsigned binary numbers or 8-bit two's-complement numbers. If the inputs are interpreted as unsigned binary, the result can be interpreted as unsigned binary. If the inputs are interpreted as two's complement, the output can be interpreted as two's complement. The only functional difference between an unsigned binary operation and a two's-complement operation is how they determine when "overflow" occurs. Unsigned binary uses carry-out (CO), while two's complement uses OFL to determine when "overflow" occurs.

- For unsigned binary operation, ACC8 can represent numbers between 0 and 255, inclusive. In add mode, CO is active (High) when the sum exceeds the bounds of the adder/subtractor. In subtract mode, CO is an active-Low borrow-out and goes Low when the difference exceeds the bounds. The carry-out (CO) is not registered synchronously with the data outputs. CO always reflects the accumulation of the B inputs (B3 : B0 for ACC4). This allows the cascading of ACC8s by connecting CO of one stage to CI of the next stage. An unsigned binary "overflow" that is always active-High can be generated by gating the ADD signal and CO as follows:

`unsigned overflow = CO XOR ADD`

Ignore OFL in unsigned binary operation.

- For two's-complement operation, ACC8 represents numbers between -128 and +127, inclusive. If an addition or subtraction operation result exceeds this range, the OFL output goes High. The overflow (OFL) is not registered synchronously with the data outputs. OFL always reflects the accumulation of the B inputs (B3 : B0 for ACC8) and the contents of the register, which allows cascading of ACC8s by connecting OFL of one stage to CI of the next stage.

Ignore CO in two's-complement operation.

The synchronous reset (R) has priority over all other inputs, and when set to High, causes all outputs to go to logic level zero during the Low-to-High clock (C) transition. Clock (C) transitions are ignored when clock enable (CE) is Low.

This design element is asynchronously cleared, outputs Low, when power is applied. For FPGA devices, power-on conditions are simulated when global set/reset (GSR) is active. GSR defaults to active-High but can be inverted by adding an inverter in front of the GSR input of the appropriate STARTUP\_architecture symbol.

### Logic Table

Input						Output
R	L	CE	ADD	D	C	Q
1	x	x	x	x	↑	0
0	1	x	x	Dn	↑	Dn
0	0	1	1	x	↑	Q0+Bn+CI
0	0	1	0	x	↑	Q0-Bn-CI
0	0	0	x	x	↑	No Change

Q0: Previous value of Q  
 Bn: Value of Data input B  
 CI: Value of input CI

### Design Entry Method

This design element is only for use in schematics.

### For More Information

See the [Spartan-6 FPGA User Documentation \(User Guides and Data Sheets\)](#).

## ADD16

Macro: 16-Bit Cascadable Full Adder with Carry-In, Carry-Out, and Overflow

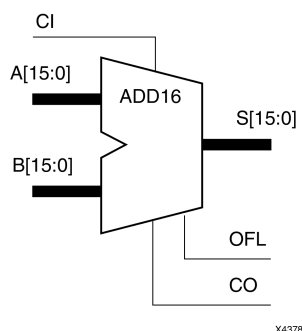

### Introduction

This design element adds two words and a carry-in (CI), producing a sum output and carry-out (CO) or overflow (OFL). The factors added are A15:A0, B15:B0 and CI, producing the sum output S15:S0 and CO (or OFL).

### Logic Table

Input		Output
<b>A</b>	<b>B</b>	<b>S</b>
A <sub>n</sub>	B <sub>n</sub>	A <sub>n</sub> +B <sub>n</sub> +CI
CI: Value of input CI.		

**Unsigned Binary Versus Two's Complement** -This design element can operate on either 16-bit unsigned binary numbers or 16-bit two's-complement numbers, respectively. If the inputs are interpreted as unsigned binary, the result can be interpreted as unsigned binary. If the inputs are interpreted as two's complement, the output can be interpreted as two's complement. The only functional difference between an unsigned binary operation and a two's-complement operation is the way they determine when "overflow" occurs. Unsigned binary uses CO, while two's-complement uses OFL to determine when "overflow" occurs. To interpret the inputs as unsigned binary, follow the CO output. To interpret the inputs as two's complement, follow the OFL output.

**Unsigned Binary Operation** -For unsigned binary operation, this element represents numbers between 0 and 65535, inclusive. OFL is ignored in unsigned binary operation.

**Two's-Complement Operation** -For two's-complement operation, this element can represent numbers between -32768 and +32767, inclusive. OFL is active (High) when the sum exceeds the bounds of the adder. CO is ignored in two's-complement operation.

### Design Entry Method

This design element is only for use in schematics.

### For More Information

See the [Spartan-6 FPGA User Documentation \(User Guides and Data Sheets\)](#).

# ADD4

## Macro: 4-Bit Cascadable Full Adder with Carry-In, Carry-Out, and Overflow

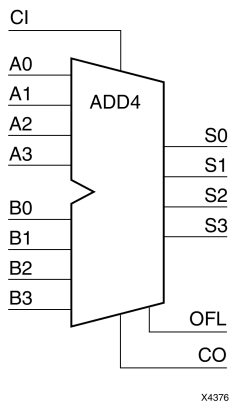

### Introduction

This design element adds two words and a carry-in (CI), producing a sum output and carry-out (CO) or overflow (OFL). The factors added are A3:A0, B3:B0, and CI producing the sum output S3:S0 and CO (or OFL).

### Logic Table

Input		Output
<b>A</b>	<b>B</b>	<b>S</b>
A <sub>n</sub>	B <sub>n</sub>	A <sub>n</sub> +B <sub>n</sub> +CI
CI: Value of input CI.		

**Unsigned Binary Versus Two's Complement** -This design element can operate on either 4-bit unsigned binary numbers or 4-bit two's-complement numbers, respectively. If the inputs are interpreted as unsigned binary, the result can be interpreted as unsigned binary. If the inputs are interpreted as two's complement, the output can be interpreted as two's complement. The only functional difference between an unsigned binary operation and a two's-complement operation is the way they determine when "overflow" occurs. Unsigned binary uses CO, while two's-complement uses OFL to determine when "overflow" occurs. To interpret the inputs as unsigned binary, follow the CO output. To interpret the inputs as two's complement, follow the OFL output.

**Unsigned Binary Operation** -For unsigned binary operation, this element represents numbers from 0 to 15, inclusive. OFL is ignored in unsigned binary operation.

**Two's-Complement Operation** -For two's-complement operation, this element can represent numbers between -8 and +7, inclusive. OFL is active (High) when the sum exceeds the bounds of the adder. CO is ignored in two's-complement operation.

### Design Entry Method

This design element is only for use in schematics.

### For More Information

See the [Spartan-6 FPGA User Documentation \(User Guides and Data Sheets\)](#).

## ADD8

Macro: 8-Bit Cascadable Full Adder with Carry-In, Carry-Out, and Overflow

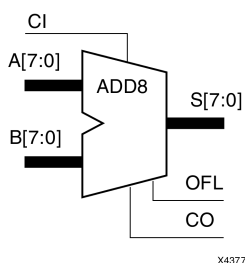

### Introduction

This design element adds two words and a carry-in (CI), producing a sum output and carry-out (CO) or overflow (OFL). The factors added are A7:A0, B7:B0, and CI, producing the sum output S7:S0 and CO (or OFL).

### Logic Table

Input		Output
<b>A</b>	<b>B</b>	<b>S</b>
A <sub>n</sub>	B <sub>n</sub>	A <sub>n</sub> +B <sub>n</sub> +CI
CI: Value of input CI.		

**Unsigned Binary Versus Two's Complement** -This design element can operate on either 8-bit unsigned binary numbers or 8-bit two's-complement numbers, respectively. If the inputs are interpreted as unsigned binary, the result can be interpreted as unsigned binary. If the inputs are interpreted as two's complement, the output can be interpreted as two's complement. The only functional difference between an unsigned binary operation and a two's-complement operation is the way they determine when "overflow" occurs. Unsigned binary uses CO, while two's-complement uses OFL to determine when "overflow" occurs. To interpret the inputs as unsigned binary, follow the CO output. To interpret the inputs as two's complement, follow the OFL output.

**Unsigned Binary Operation** -For unsigned binary operation, this element represents numbers between 0 and 255, inclusive. OFL is ignored in unsigned binary operation.

**Two's-Complement Operation** -For two's-complement operation, this element can represent numbers between -128 and +127, inclusive. OFL is active (High) when the sum exceeds the bounds of the adder. CO is ignored in two's-complement operation.

### Design Entry Method

This design element is only for use in schematics.

### For More Information

See the [Spartan-6 FPGA User Documentation \(User Guides and Data Sheets\)](#).

# ADSU16

## Macro: 16-Bit Cascadable Adder/Subtractor with Carry-In, Carry-Out, and Overflow

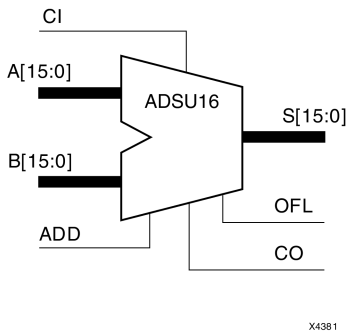

### Introduction

When the ADD input is High, this element adds two 16-bit words (A15:A0 and B15:B0) and a carry-in (CI), producing a 16-bit sum output (S15:S0) and carry-out (CO) or overflow (OFL).

When the ADD input is Low, this element subtracts B15:B0 from A15:A0, producing a difference output and a carry-out (CO) or an overflow (OFL).

In add mode, CO and CI are active-High. In subtract mode, CO and CI are active-Low. OFL is active-High in add and subtract modes.

### Logic Table

Input			Output
ADD	A	B	S
1	A <sub>n</sub>	B <sub>n</sub>	A <sub>n</sub> +B <sub>n</sub> +CI*
0	A <sub>n</sub>	B <sub>n</sub>	A <sub>n</sub> -B <sub>n</sub> -CI*
CI*: ADD = 0, CI, CO active LOW			
CI*: ADD = 1, CI, CO active HIGH			

**Unsigned Binary Versus Two's Complement** -This design element can operate on either 16-bit unsigned binary numbers or 16-bit two's-complement numbers. If the inputs are interpreted as unsigned binary, the result can be interpreted as unsigned binary. If the inputs are interpreted as two's complement, the output can be interpreted as two's complement. The only functional difference between an unsigned binary operation and a two's-complement operation is the way they determine when "overflow" occurs. Unsigned binary uses CO, while two's complement uses OFL to determine when "overflow" occurs.

With adder/subtractors, either unsigned binary or two's-complement operations cause an overflow. If the result crosses the overflow boundary, an overflow is generated. Similarly, when the result crosses the carry-out boundary, a carry-out is generated.

**Unsigned Binary Operation** -For unsigned binary operation, this element can represent numbers between 0 and 65535, inclusive. In add mode, CO is active (High) when the sum exceeds the bounds of the adder/subtractor. In subtract mode, CO is an active-Low borrow-out and goes Low when the difference exceeds the bounds.

An unsigned binary "overflow" that is always active-High can be generated by gating the ADD signal and CO as follows:

$$\text{unsigned overflow} = \text{CO XOR ADD}$$

OFL is ignored in unsigned binary operation.

**Two's-Complement Operation** -For two's-complement operation, this element can represent numbers between -32768 and +32767, inclusive.

If an addition or subtraction operation result exceeds this range, the OFL output goes High. CO is ignored in two's-complement operation.

## Design Entry Method

This design element is only for use in schematics.

## For More Information

See the [Spartan-6 FPGA User Documentation \(User Guides and Data Sheets\)](#).



# ADSU4

## Macro: 4-Bit Cascadable Adder/Subtractor with Carry-In, Carry-Out, and Overflow

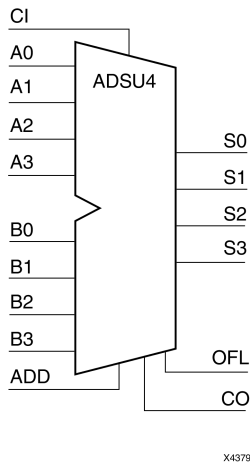

### Introduction

When the ADD input is High, this element adds two 4-bit words (A3:A0 and B3:B0) and a carry-in (CI), producing a 4-bit sum output (S3:S0) and a carry-out (CO) or an overflow (OFL).

When the ADD input is Low, this element subtracts B3:B0 from A3:A0, producing a 4-bit difference output (S3:S0) and a carry-out (CO) or an overflow (OFL).

In add mode, CO and CI are active-High. In subtract mode, CO and CI are active-Low. OFL is active-High in add and subtract modes.

### Logic Table

Input			Output
ADD	A	B	S
1	A <sub>n</sub>	B <sub>n</sub>	A <sub>n</sub> +B <sub>n</sub> +CI*
0	A <sub>n</sub>	B <sub>n</sub>	A <sub>n</sub> -B <sub>n</sub> -CI*

CI\*: ADD = 0, CI, CO active LOW  
 CI\*: ADD = 1, CI, CO active HIGH

**Unsigned Binary Versus Two's Complement** -This design element can operate on either 4-bit unsigned binary numbers or 4-bit two's-complement numbers. If the inputs are interpreted as unsigned binary, the result can be interpreted as unsigned binary. If the inputs are interpreted as two's complement, the output can be interpreted as two's complement. The only functional difference between an unsigned binary operation and a two's-complement operation is the way they determine when "overflow" occurs. Unsigned binary uses CO, while two's complement uses OFL to determine when "overflow" occurs.

With adder/subtractors, either unsigned binary or two's-complement operations cause an overflow. If the result crosses the overflow boundary, an overflow is generated. Similarly, when the result crosses the carry-out boundary, a carry-out is generated.

**Unsigned Binary Operation** -For unsigned binary operation, ADSU4 can represent numbers between 0 and 15, inclusive. In add mode, CO is active (High) when the sum exceeds the bounds of the adder/subtractor. In subtract mode, CO is an active-Low borrow-out and goes Low when the difference exceeds the bounds.

An unsigned binary "overflow" that is always active-High can be generated by gating the ADD signal and CO as follows:

unsigned overflow = CO XOR ADD

OFL is ignored in unsigned binary operation.

**Two's-Complement Operation** -For two's-complement operation, this element can represent numbers between -8 and +7, inclusive.

If an addition or subtraction operation result exceeds this range, the OFL output goes High. CO is ignored in two's-complement operation.

## Design Entry Method

This design element is only for use in schematics.

## For More Information

See the [Spartan-6 FPGA User Documentation \(User Guides and Data Sheets\)](#).

# ADSU8

## Macro: 8-Bit Cascadable Adder/Subtractor with Carry-In, Carry-Out, and Overflow

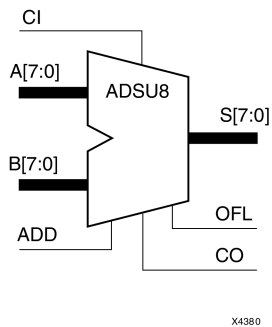

### Introduction

When the ADD input is High, this element adds two 8-bit words (A7:A0 and B7:B0) and a carry-in (CI), producing an 8-bit sum output (S7:S0) and carry-out (CO) or an overflow (OFL).

When the ADD input is Low, this element subtracts B7:B0 from A7:A0, producing an 8-bit difference output (S7:S0) and a carry-out (CO) or an overflow (OFL).

In add mode, CO and CI are active-High. In subtract mode, CO and CI are active-Low. OFL is active-High in add and subtract modes.

### Logic Table

Input			Output
ADD	A	B	S
1	A <sub>n</sub>	B <sub>n</sub>	A <sub>n</sub> +B <sub>n</sub> +CI*
0	A <sub>n</sub>	B <sub>n</sub>	A <sub>n</sub> -B <sub>n</sub> -CI*
CI*: ADD = 0, CI, CO active LOW			
CI*: ADD = 1, CI, CO active HIGH			

**Unsigned Binary Versus Two's Complement** -This design element can operate on either 8-bit unsigned binary numbers or 8-bit two's-complement numbers. If the inputs are interpreted as unsigned binary, the result can be interpreted as unsigned binary. If the inputs are interpreted as two's complement, the output can be interpreted as two's complement. The only functional difference between an unsigned binary operation and a two's-complement operation is the way they determine when "overflow" occurs. Unsigned binary uses CO, while two's complement uses OFL to determine when "overflow" occurs.

With adder/subtractors, either unsigned binary or two's-complement operations cause an overflow. If the result crosses the overflow boundary, an overflow is generated. Similarly, when the result crosses the carry-out boundary, a carry-out is generated.

**Unsigned Binary Operation** -For unsigned binary operation, this element can represent numbers between 0 and 255, inclusive. In add mode, CO is active (High) when the sum exceeds the bounds of the adder/subtractor. In subtract mode, CO is an active-Low borrow-out and goes Low when the difference exceeds the bounds.

An unsigned binary "overflow" that is always active-High can be generated by gating the ADD signal and CO as follows:

$$\text{unsigned overflow} = \text{CO XOR ADD}$$

OFL is ignored in unsigned binary operation.

**Two's-Complement Operation** -For two's-complement operation, this element can represent numbers between -128 and +127, inclusive.

If an addition or subtraction operation result exceeds this range, the OFL output goes High. CO is ignored in two's-complement operation.

## Design Entry Method

This design element is only for use in schematics.

## For More Information

See the [Spartan-6 FPGA User Documentation \(User Guides and Data Sheets\)](#).

## AND12

### Macro: 12- Input AND Gate with Non-Inverted Inputs

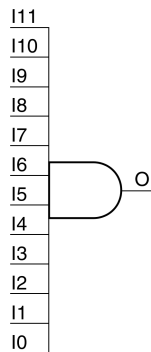

AND12

X9459

## Introduction

AND elements implement logical conjunction. A High output (1) results only if all inputs are High (1). A Low (0) output results if any inputs are Low (0).

AND functions of up to five inputs are available in any combination of inverting and non-inverting inputs. AND functions of six to nine inputs, 12 inputs, and 16 inputs are available with noninverting inputs. To make some or all inputs inverting, use external inverters. Because each input uses a CLB resource, replace functions with unused inputs with functions having the appropriate number of inputs.

## Logic Table

Input	Output
I0 ... Iz	O
All inputs are 1	1
Any single input is 0	0

## Design Entry Method

This design element is only for use in schematics.

## For More Information

See the [Spartan-6 FPGA User Documentation \(User Guides and Data Sheets\)](#).

## AND16

### 16- Input AND Gate with Non-Inverted Inputs

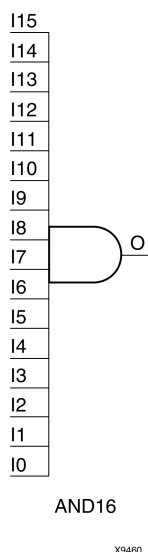

## Introduction

AND elements implement logical conjunction. A High output (1) results only if all inputs are High (1). A Low (0) output results if any inputs are Low (0).

AND functions of up to five inputs are available in any combination of inverting and non-inverting inputs. AND functions of six to nine inputs, 12 inputs, and 16 inputs are available with noninverting inputs. To make some or all inputs inverting, use external inverters. Because each input uses a CLB resource, replace functions with unused inputs with functions having the appropriate number of inputs.

## Logic Table

Input	Output
I0 ... Iz	O
All inputs are 1	1
Any single input is 0	0

## Design Entry Method

This design element is only for use in schematics.

## For More Information

See the [Spartan-6 FPGA User Documentation \(User Guides and Data Sheets\)](#).

## AND2

### Primitive: 2-Input AND Gate with Non-Inverted Inputs

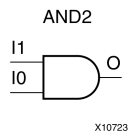

## Introduction

AND elements implement logical conjunction. A High output (1) results only if all inputs are High (1). A Low (0) output results if any inputs are Low (0).

AND functions of up to five inputs are available in any combination of inverting and non-inverting inputs. AND functions of six to nine inputs, 12 inputs, and 16 inputs are available with noninverting inputs. To make some or all inputs inverting, use external inverters. Because each input uses a CLB resource, replace functions with unused inputs with functions having the appropriate number of inputs.

## Logic Table

Input	Output
I0 ... Iz	0
All inputs are 1	1
Any single input is 0	0

## Design Entry Method

This design element is only for use in schematics.

## For More Information

See the [Spartan-6 FPGA User Documentation \(User Guides and Data Sheets\)](#).

## AND2B1

Primitive: 2-Input AND Gate with 1 Inverted and 1 Non-Inverted Inputs

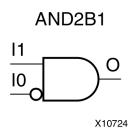

### Introduction

AND elements implement logical conjunction. A High output (1) results only if all inputs are High (1). A Low (0) output results if any inputs are Low (0).

AND functions of up to five inputs are available in any combination of inverting and non-inverting inputs. AND functions of six to nine inputs, 12 inputs, and 16 inputs are available with noninverting inputs. To make some or all inputs inverting, use external inverters. Because each input uses a CLB resource, replace functions with unused inputs with functions having the appropriate number of inputs.

### Design Entry Method

This design element is only for use in schematics.

### For More Information

See the [Spartan-6 FPGA User Documentation \(User Guides and Data Sheets\)](#).



## AND2B1L

Primitive: Two input AND gate implemented in place of a Slice Latch

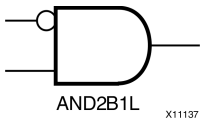

### Introduction

This element allows the specification of a configurable Slice latch to take the function of a two input AND gate with one input inverted (see Logic Table). The use of this element can reduce logic levels and increase logic density of the part by trading off register/latch resources for logic. Xilinx suggests caution when using this component as it can affect register packing and density since specifying one or more AND2B1L or OR2L components in a Slice disallows the use of the remaining registers and latches.

### Logic Table

Inputs		Outputs
DI	SRI	O
0	0	0
0	1	0
1	0	1
1	1	0

### Port Descriptions

Port	Direction	Width	Function
O	Output	1	Output of the AND gate.
DI	Input	1	Active high input that is generally connected to sourcing LUT located in the same Slice.
SRI	Input	1	Active low input that is generally source from outside of the Slice. <b>Note</b> To allow more than one AND2B1L or OR2B1L to be packed into a single Slice, a common signal must be connected to this input.

### Design Entry Method

This design element can be used in schematics.

### For More Information

- See the [Spartan-6 FPGA Configurable Logic Block User Guide \(UG384\)](#).
- See the [Spartan-6 FPGA Data Sheet: DC and Switching Characteristics \(DS162\)](#).

## AND2B2

### Primitive: 2-Input AND Gate with Inverted Inputs

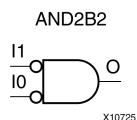

## Introduction

AND elements implement logical conjunction. A High output (1) results only if all inputs are High (1). A Low (0) output results if any inputs are Low (0).

AND functions of up to five inputs are available in any combination of inverting and non-inverting inputs. AND functions of six to nine inputs, 12 inputs, and 16 inputs are available with noninverting inputs. To make some or all inputs inverting, use external inverters. Because each input uses a CLB resource, replace functions with unused inputs with functions having the appropriate number of inputs.

## Design Entry Method

This design element is only for use in schematics.

## For More Information

See the [Spartan-6 FPGA User Documentation \(User Guides and Data Sheets\)](#).

## AND3

### Primitive: 3-Input AND Gate with Non-Inverted Inputs

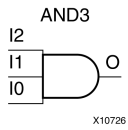

## Introduction

AND elements implement logical conjunction. A High output (1) results only if all inputs are High (1). A Low (0) output results if any inputs are Low (0).

AND functions of up to five inputs are available in any combination of inverting and non-inverting inputs. AND functions of six to nine inputs, 12 inputs, and 16 inputs are available with noninverting inputs. To make some or all inputs inverting, use external inverters. Because each input uses a CLB resource, replace functions with unused inputs with functions having the appropriate number of inputs.

## Logic Table

Input	Output
I0 ... Iz	0
All inputs are 1	1
Any single input is 0	0

## Design Entry Method

This design element is only for use in schematics.

## For More Information

See the [Spartan-6 FPGA User Documentation \(User Guides and Data Sheets\)](#).

## AND3B1

Primitive: 3-Input AND Gate with 1 Inverted and 2 Non-Inverted Inputs

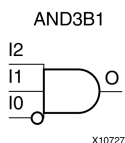

### Introduction

AND elements implement logical conjunction. A High output (1) results only if all inputs are High (1). A Low (0) output results if any inputs are Low (0).

AND functions of up to five inputs are available in any combination of inverting and non-inverting inputs. AND functions of six to nine inputs, 12 inputs, and 16 inputs are available with noninverting inputs. To make some or all inputs inverting, use external inverters. Because each input uses a CLB resource, replace functions with unused inputs with functions having the appropriate number of inputs.

### Design Entry Method

This design element is only for use in schematics.

### For More Information

See the [Spartan-6 FPGA User Documentation \(User Guides and Data Sheets\)](#).

## AND3B2

Primitive: 3-Input AND Gate with 2 Inverted and 1 Non-Inverted Inputs

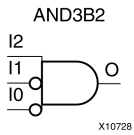

### Introduction

AND elements implement logical conjunction. A High output (1) results only if all inputs are High (1). A Low (0) output results if any inputs are Low (0).

AND functions of up to five inputs are available in any combination of inverting and non-inverting inputs. AND functions of six to nine inputs, 12 inputs, and 16 inputs are available with noninverting inputs. To make some or all inputs inverting, use external inverters. Because each input uses a CLB resource, replace functions with unused inputs with functions having the appropriate number of inputs.

### Design Entry Method

This design element is only for use in schematics.

### For More Information

See the [Spartan-6 FPGA User Documentation \(User Guides and Data Sheets\)](#).

## AND3B3

### Primitive: 3-Input AND Gate with Inverted Inputs

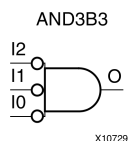

## Introduction

AND elements implement logical conjunction. A High output (1) results only if all inputs are High (1). A Low (0) output results if any inputs are Low (0).

AND functions of up to five inputs are available in any combination of inverting and non-inverting inputs. AND functions of six to nine inputs, 12 inputs, and 16 inputs are available with noninverting inputs. To make some or all inputs inverting, use external inverters. Because each input uses a CLB resource, replace functions with unused inputs with functions having the appropriate number of inputs.

## Design Entry Method

This design element is only for use in schematics.

## For More Information

See the [Spartan-6 FPGA User Documentation \(User Guides and Data Sheets\)](#).

## AND4

### Primitive: 4-Input AND Gate with Non-Inverted Inputs

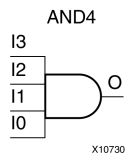

## Introduction

AND elements implement logical conjunction. A High output (1) results only if all inputs are High (1). A Low (0) output results if any inputs are Low (0).

AND functions of up to five inputs are available in any combination of inverting and non-inverting inputs. AND functions of six to nine inputs, 12 inputs, and 16 inputs are available with noninverting inputs. To make some or all inputs inverting, use external inverters. Because each input uses a CLB resource, replace functions with unused inputs with functions having the appropriate number of inputs.

## Logic Table

Input	Output
I0 ... Iz	0
All inputs are 1	1
Any single input is 0	0

## Design Entry Method

This design element is only for use in schematics.

## For More Information

See the [Spartan-6 FPGA User Documentation \(User Guides and Data Sheets\)](#).

## AND4B1

Primitive: 4-Input AND Gate with 1 Inverted and 3 Non-Inverted Inputs

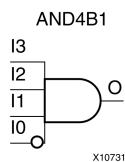

### Introduction

AND elements implement logical conjunction. A High output (1) results only if all inputs are High (1). A Low (0) output results if any inputs are Low (0).

AND functions of up to five inputs are available in any combination of inverting and non-inverting inputs. AND functions of six to nine inputs, 12 inputs, and 16 inputs are available with noninverting inputs. To make some or all inputs inverting, use external inverters. Because each input uses a CLB resource, replace functions with unused inputs with functions having the appropriate number of inputs.

### Design Entry Method

This design element is only for use in schematics.

### For More Information

See the [Spartan-6 FPGA User Documentation \(User Guides and Data Sheets\)](#).



## AND4B2

Primitive: 4-Input AND Gate with 2 Inverted and 2 Non-Inverted Inputs

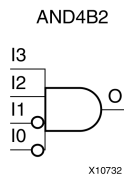

### Introduction

AND elements implement logical conjunction. A High output (1) results only if all inputs are High (1). A Low (0) output results if any inputs are Low (0).

AND functions of up to five inputs are available in any combination of inverting and non-inverting inputs. AND functions of six to nine inputs, 12 inputs, and 16 inputs are available with noninverting inputs. To make some or all inputs inverting, use external inverters. Because each input uses a CLB resource, replace functions with unused inputs with functions having the appropriate number of inputs.

### Design Entry Method

This design element is only for use in schematics.

### For More Information

See the [Spartan-6 FPGA User Documentation \(User Guides and Data Sheets\)](#).

## AND4B3

Primitive: 4-Input AND Gate with 3 Inverted and 1 Non-Inverted Inputs

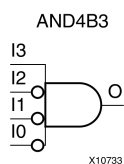

### Introduction

AND elements implement logical conjunction. A High output (1) results only if all inputs are High (1). A Low (0) output results if any inputs are Low (0).

AND functions of up to five inputs are available in any combination of inverting and non-inverting inputs. AND functions of six to nine inputs, 12 inputs, and 16 inputs are available with noninverting inputs. To make some or all inputs inverting, use external inverters. Because each input uses a CLB resource, replace functions with unused inputs with functions having the appropriate number of inputs.

### Design Entry Method

This design element is only for use in schematics.

### For More Information

See the [Spartan-6 FPGA User Documentation \(User Guides and Data Sheets\)](#).

## AND4B4

### Primitive: 4-Input AND Gate with Inverted Inputs

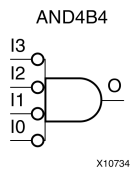

## Introduction

AND elements implement logical conjunction. A High output (1) results only if all inputs are High (1). A Low (0) output results if any inputs are Low (0).

AND functions of up to five inputs are available in any combination of inverting and non-inverting inputs. AND functions of six to nine inputs, 12 inputs, and 16 inputs are available with noninverting inputs. To make some or all inputs inverting, use external inverters. Because each input uses a CLB resource, replace functions with unused inputs with functions having the appropriate number of inputs.

## Design Entry Method

This design element is only for use in schematics.

## For More Information

See the [Spartan-6 FPGA User Documentation \(User Guides and Data Sheets\)](#).

## AND5

### Primitive: 5-Input AND Gate with Non-Inverted Inputs

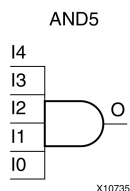

## Introduction

AND elements implement logical conjunction. A High output (1) results only if all inputs are High (1). A Low (0) output results if any inputs are Low (0).

AND functions of up to five inputs are available in any combination of inverting and non-inverting inputs. AND functions of six to nine inputs, 12 inputs, and 16 inputs are available with noninverting inputs. To make some or all inputs inverting, use external inverters. Because each input uses a CLB resource, replace functions with unused inputs with functions having the appropriate number of inputs.

## Logic Table

Input	Output
I0 ... Iz	0
All inputs are 1	1
Any single input is 0	0

## Design Entry Method

This design element is only for use in schematics.

## For More Information

See the [Spartan-6 FPGA User Documentation \(User Guides and Data Sheets\)](#).

## AND5B1

Primitive: 5-Input AND Gate with 1 Inverted and 4 Non-Inverted Inputs

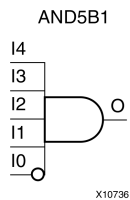

### Introduction

AND elements implement logical conjunction. A High output (1) results only if all inputs are High (1). A Low (0) output results if any inputs are Low (0).

AND functions of up to five inputs are available in any combination of inverting and non-inverting inputs. AND functions of six to nine inputs, 12 inputs, and 16 inputs are available with noninverting inputs. To make some or all inputs inverting, use external inverters. Because each input uses a CLB resource, replace functions with unused inputs with functions having the appropriate number of inputs.

### Design Entry Method

This design element is only for use in schematics.

### For More Information

See the [Spartan-6 FPGA User Documentation \(User Guides and Data Sheets\)](#).

## AND5B2

### Primitive: 5-Input AND Gate with 2 Inverted and 3 Non-Inverted Inputs

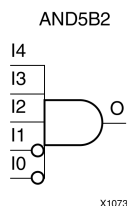

## Introduction

AND elements implement logical conjunction. A High output (1) results only if all inputs are High (1). A Low (0) output results if any inputs are Low (0).

AND functions of up to five inputs are available in any combination of inverting and non-inverting inputs. AND functions of six to nine inputs, 12 inputs, and 16 inputs are available with noninverting inputs. To make some or all inputs inverting, use external inverters. Because each input uses a CLB resource, replace functions with unused inputs with functions having the appropriate number of inputs.

## Design Entry Method

This design element is only for use in schematics.

## For More Information

See the [Spartan-6 FPGA User Documentation \(User Guides and Data Sheets\)](#).

## AND5B3

Primitive: 5-Input AND Gate with 3 Inverted and 2 Non-Inverted Inputs

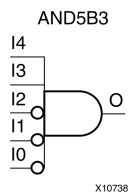

### Introduction

AND elements implement logical conjunction. A High output (1) results only if all inputs are High (1). A Low (0) output results if any inputs are Low (0).

AND functions of up to five inputs are available in any combination of inverting and non-inverting inputs. AND functions of six to nine inputs, 12 inputs, and 16 inputs are available with noninverting inputs. To make some or all inputs inverting, use external inverters. Because each input uses a CLB resource, replace functions with unused inputs with functions having the appropriate number of inputs.

### Design Entry Method

This design element is only for use in schematics.

### For More Information

See the [Spartan-6 FPGA User Documentation \(User Guides and Data Sheets\)](#).

## AND5B4

Primitive: 5-Input AND Gate with 4 Inverted and 1 Non-Inverted Inputs

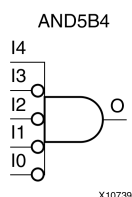

### Introduction

AND elements implement logical conjunction. A High output (1) results only if all inputs are High (1). A Low (0) output results if any inputs are Low (0).

AND functions of up to five inputs are available in any combination of inverting and non-inverting inputs. AND functions of six to nine inputs, 12 inputs, and 16 inputs are available with noninverting inputs. To make some or all inputs inverting, use external inverters. Because each input uses a CLB resource, replace functions with unused inputs with functions having the appropriate number of inputs.

### Design Entry Method

This design element is only for use in schematics.

### For More Information

See the [Spartan-6 FPGA User Documentation \(User Guides and Data Sheets\)](#).



## AND5B5

### Primitive: 5-Input AND Gate with Inverted Inputs

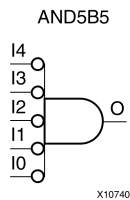

## Introduction

AND elements implement logical conjunction. A High output (1) results only if all inputs are High (1). A Low (0) output results if any inputs are Low (0).

AND functions of up to five inputs are available in any combination of inverting and non-inverting inputs. AND functions of six to nine inputs, 12 inputs, and 16 inputs are available with noninverting inputs. To make some or all inputs inverting, use external inverters. Because each input uses a CLB resource, replace functions with unused inputs with functions having the appropriate number of inputs.

## Design Entry Method

This design element is only for use in schematics.

## For More Information

See the [Spartan-6 FPGA User Documentation \(User Guides and Data Sheets\)](#).

## AND6

### Macro: 6-Input AND Gate with Non-Inverted Inputs

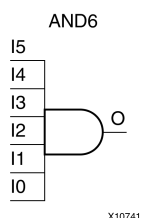

## Introduction

AND elements implement logical conjunction. A High output (1) results only if all inputs are High (1). A Low (0) output results if any inputs are Low (0).

AND functions of up to five inputs are available in any combination of inverting and non-inverting inputs. AND functions of six to nine inputs, 12 inputs, and 16 inputs are available with noninverting inputs. To make some or all inputs inverting, use external inverters. Because each input uses a CLB resource, replace functions with unused inputs with functions having the appropriate number of inputs.

## Logic Table

Input	Output
I0 ... Iz	O
All inputs are 1	1
Any single input is 0	0

## Design Entry Method

This design element is only for use in schematics.

## For More Information

See the [Spartan-6 FPGA User Documentation \(User Guides and Data Sheets\)](#).

## AND7

### Macro: 7-Input AND Gate with Non-Inverted Inputs

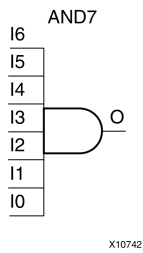

## Introduction

AND elements implement logical conjunction. A High output (1) results only if all inputs are High (1). A Low (0) output results if any inputs are Low (0).

AND functions of up to five inputs are available in any combination of inverting and non-inverting inputs. AND functions of six to nine inputs, 12 inputs, and 16 inputs are available with noninverting inputs. To make some or all inputs inverting, use external inverters. Because each input uses a CLB resource, replace functions with unused inputs with functions having the appropriate number of inputs.

## Logic Table

Input	Output
I0 ... Iz	O
All inputs are 1	1
Any single input is 0	0

## Design Entry Method

This design element is only for use in schematics.

## For More Information

See the [Spartan-6 FPGA User Documentation \(User Guides and Data Sheets\)](#).

## AND8

### Macro: 8-Input AND Gate with Non-Inverted Inputs

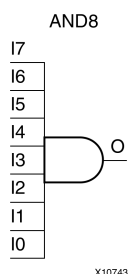

## Introduction

AND elements implement logical conjunction. A High output (1) results only if all inputs are High (1). A Low (0) output results if any inputs are Low (0).

AND functions of up to five inputs are available in any combination of inverting and non-inverting inputs. AND functions of six to nine inputs, 12 inputs, and 16 inputs are available with noninverting inputs. To make some or all inputs inverting, use external inverters. Because each input uses a CLB resource, replace functions with unused inputs with functions having the appropriate number of inputs.

## Logic Table

Input	Output
I0 ... Iz	O
All inputs are 1	1
Any single input is 0	0

## Design Entry Method

This design element is only for use in schematics.

## For More Information

See the [Spartan-6 FPGA User Documentation \(User Guides and Data Sheets\)](#).

## AND9

### Macro: 9-Input AND Gate with Non-Inverted Inputs

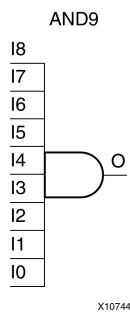

## Introduction

AND elements implement logical conjunction. A High output (1) results only if all inputs are High (1). A Low (0) output results if any inputs are Low (0).

AND functions of up to five inputs are available in any combination of inverting and non-inverting inputs. AND functions of six to nine inputs, 12 inputs, and 16 inputs are available with noninverting inputs. To make some or all inputs inverting, use external inverters. Because each input uses a CLB resource, replace functions with unused inputs with functions having the appropriate number of inputs.

## Logic Table

Input	Output
I0 ... Iz	0
All inputs are 1	1
Any single input is 0	0

## Design Entry Method

This design element is only for use in schematics.

## For More Information

See the [Spartan-6 FPGA User Documentation \(User Guides and Data Sheets\)](#).

## BRLSHFT4

### Macro: 4-Bit Barrel Shifter

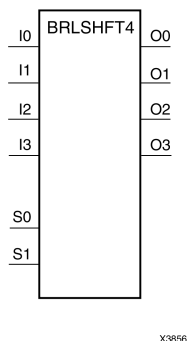

## Introduction

This design element is a 4-bit barrel shifter that can rotate four inputs (I3 : I0) up to four places. The control inputs (S1 and S0) determine the number of positions, from one to four, that the data is rotated. The four outputs (O3 : O0) reflect the shifted data inputs.

## Logic Table

Inputs						Outputs			
S1	S0	I0	I1	I2	I3	O0	O1	O2	O3
0	0	a	b	c	d	a	b	c	d
0	1	a	b	c	d	b	c	d	a
1	0	a	b	c	d	c	d	a	b
1	1	a	b	c	d	d	a	b	c

## Design Entry Method

This design element is only for use in schematics.

## For More Information

See the [Spartan-6 FPGA User Documentation \(User Guides and Data Sheets\)](#).

# BRLSHFT8

## Macro: 8-Bit Barrel Shifter

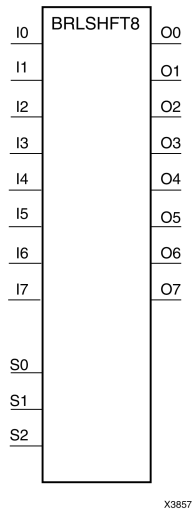

## Introduction

This design element is an 8-bit barrel shifter, can rotate the eight inputs (I7 : I0) up to eight places. The control inputs (S2 : S0) determine the number of positions, from one to eight, that the data is rotated. The eight outputs (O7 : O0) reflect the shifted data inputs.

## Logic Table

Inputs											Outputs							
S2	S1	S0	I0	I1	I2	I3	I4	I5	I6	I7	O0	O1	O2	O3	O4	O5	O6	O7
0	0	0	a	b	c	d	e	f	g	h	a	b	c	d	e	f	g	h
0	0	1	a	b	c	d	e	f	g	h	b	c	d	e	f	g	h	a
0	1	0	a	b	c	d	e	f	g	h	c	d	e	f	g	h	a	b
0	1	1	a	b	c	d	e	f	g	h	d	e	f	g	h	a	b	c
1	0	0	a	b	c	d	e	f	g	h	e	f	g	h	a	b	c	d
1	0	1	a	b	c	d	e	f	g	h	f	g	h	a	b	c	d	e
1	1	0	a	b	c	d	e	f	g	h	g	h	a	b	c	d	e	f
1	1	1	a	b	c	d	e	f	g	h	h	a	b	c	d	e	f	g

## Design Entry Method

This design element is only for use in schematics.

## For More Information

See the [Spartan-6 FPGA User Documentation \(User Guides and Data Sheets\)](#).

## BSCAN\_SPARTAN6

### Primitive: Spartan®-6 JTAG Boundary Scan Logic Control Circuit

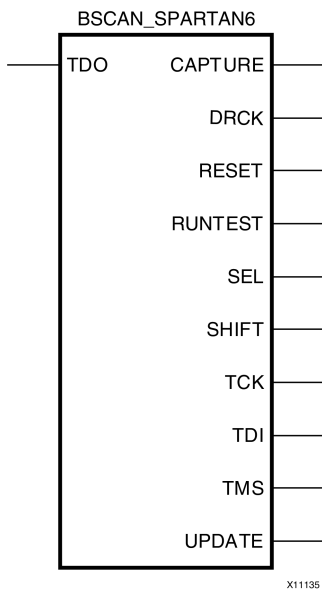

## Introduction

This design element allows access to and from internal logic by the JTAG Boundary Scan logic controller. This allows for communication between the internal running design and the dedicated JTAG pins of the FPGA.

Each instance of this design element will handle one JTAG USER instruction (USER1 through USER4) as set with the JTAG\_CHAIN attribute. To handle all four USER instructions, instantiate four of these elements and set the JTAG\_CHAIN attribute appropriately.

**Note** For specific information on boundary scan for an architecture, see the *Spartan-6 Configuration User Guide* for this element.

## Port Descriptions

Port	Direction	Width	Function
CAPTURE	Output	1	CAPTURE output from TAP controller.
DRCK	Output	1	Data register output for USER functions.
RESET	Output	1	Reset output for TAP controller.
RUNTEST	Output	1	Output signal that gets asserted when TAP controller is in Run Test Idle state.
SEL	Output	1	USER active output.
SHIFT	Output	1	SHIFT output from TAP controller.
TCK	Output	1	Scan Clock output. Fabric connection to TAP Clock pin.
TDI	Output	1	TDI output from TAP controller.
TDO	Input	1	Data input for USER function.
TMS	Output	1	Test Mode Select output. Fabric connection to TAP.
UPDATE	Output	1	UPDATE output from TAP controller.



## Design Entry Method

This design element can be used in schematics.

### Available Attributes

Attribute	Data Type	Allowed Values	Default	Description
JTAG_CHAIN	Integer	1, 2, 3, 4	1	Sets the JTAG USER instruction number that this instance of the element will handle.

### For More Information

- See the [Spartan-6 FPGA Configuration User Guide \(UG380\)](#).
- See the [Spartan-6 FPGA Data Sheet: DC and Switching Characteristics \(DS162\)](#).

## BUF

Primitive: General Purpose Buffer

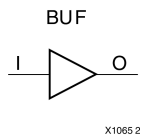

### Introduction

This is a general-purpose, non-inverting buffer.

This element is not necessary and is removed by the partitioning software (MAP).

### Design Entry Method

This design element is only for use in schematics.

### For More Information

See the [Spartan-6 FPGA User Documentation \(User Guides and Data Sheets\)](#).

## BUFCF

### Primitive: Fast Connect Buffer

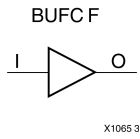

## Introduction

This design element is a single fast connect buffer used to connect the outputs of the LUTs and some dedicated logic directly to the input of another LUT. Using this buffer implies CLB packing. No more than four LUTs may be connected together as a group.

## Design Entry Method

This design element can be used in schematics.

## For More Information

See the [Spartan-6 FPGA User Documentation \(User Guides and Data Sheets\)](#).

## BUFG

Primitive: Global Clock Buffer

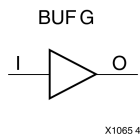

### Introduction

This design element is a high-fanout buffer that connects signals to the global routing resources for low skew distribution of the signal. BUFs are typically used on clock nets as well other high fanout nets like sets/resets and clock enables.

### Port Descriptions

Port	Direction	Width	Function
I	Input	1	Clock buffer input
O	Output	1	Clock buffer output

### Design Entry Method

This design element can be used in schematics.

### For More Information

- See the [Spartan-6 FPGA Clocking Resources User Guide \(UG382\)](#).
- See the [Spartan-6 FPGA Data Sheet: DC and Switching Characteristics \(DS162\)](#).

## BUFGCE

Primitive: Global Clock Buffer with Clock Enable

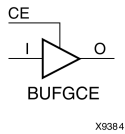

### Introduction

This design element is a global clock buffer with a single gated input. Its O output is "0" when clock enable (CE) is Low (inactive). When clock enable (CE) is High, the I input is transferred to the O output.

### Logic Table

Inputs		Outputs
I	CE	O
X	0	0
I	1	I

### Port Descriptions

Port	Direction	Width	Function
I	Input	1	Clock buffer input
CE	Input	1	Clock enable input
O	Output	1	Clock buffer output

### Design Entry Method

This design element can be used in schematics.

### For More Information

- See the [Spartan-6 FPGA Clocking Resources User Guide \(UG382\)](#).
- See the [Spartan-6 FPGA Data Sheet: DC and Switching Characteristics \(DS162\)](#).

## BUFGCE\_1

Primitive: Global Clock Buffer with Clock Enable and Output State 1

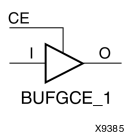

### Introduction

This design element is a multiplexed global clock buffer with a single gated input. Its O output is High (1) when clock enable (CE) is Low (inactive). When clock enable (CE) is High, the I input is transferred to the O output.

### Logic Table

Inputs		Outputs
I	CE	O
X	0	1
I	1	I

### Port Descriptions

Port	Direction	Width	Function
I	Input	1	Clock buffer input
CE	Input	1	Clock enable input
O	Output	1	Clock buffer output

### Design Entry Method

This design element can be used in schematics.

### For More Information

- See the [Spartan-6 FPGA Clocking Resources User Guide \(UG382\)](#).
- See the [Spartan-6 FPGA Data Sheet: DC and Switching Characteristics \(DS162\)](#).

# BUFGMUX

## Primitive: Global Clock MUX Buffer

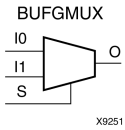

## Introduction

BUFGMUX is a multiplexed global clock buffer that can select between two input clocks: I0 and I1. When the select input (S) is Low, the signal on I0 is selected for output (O). When the select input (S) is High, the signal on I1 is selected for output.

BUFGMUX and BUFGMUX\_1 are distinguished by the state the output assumes when that output switches between clocks in response to a change in its select input. BUFGMUX assumes output state 0 and BUFGMUX\_1 assumes output state 1.

**Note** BUFGMUX guarantees that when S is toggled, the state of the output remains in the inactive state until the next active clock edge (either I0 or I1) occurs.

## Logic Table

Inputs			Outputs
I0	I1	S	O
I0	X	0	I0
X	I1	1	I1
X	X	↑	0
X	X	↓	0

## Port Descriptions

Port	Direction	Width	Function
I0	Input	1	Clock0 input
I1	Input	1	Clock1 input
O	Output	1	Clock MUX output
S	Input	1	Clock select input

## Design Entry Method

This design element can be used in schematics.

## Available Attributes

Attribute	Data Type	Allowed Values	Default	Description
CLK_SEL_TYPE	String	"SYNC", "ASYNC"	"SYNC"	Specifies synchronous or asynchronous clock.

## For More Information

- See the [Spartan-6 FPGA Clocking Resources User Guide \(UG382\)](#).
- See the [Spartan-6 FPGA Data Sheet: DC and Switching Characteristics \(DS162\)](#).



## BUFGMUX\_1

### Primitive: Global Clock MUX Buffer with Output State 1

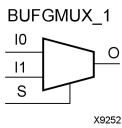

## Introduction

This design element is a multiplexed global clock buffer that can select between two input clocks: I0 and I1. When the select input (S) is Low, the signal on I0 is selected for output (O). When the select input (S) is High, the signal on I1 is selected for output.

This design element is distinguished from BUFGMUX by the state the output assumes when that output switches between clocks in response to a change in its select input. BUFGMUX assumes output state 0 and BUFGMUX\_1 assumes output state 1.

## Logic Table

Inputs			Outputs
I0	I1	S	O
I0	X	0	I0
X	I1	1	I1
X	X	↑	1
X	X	↓	1

## Port Descriptions

Port	Direction	Width	Function
I0	Input	1	Clock0 input
I1	Input	1	Clock1 input
O	Output	1	Clock MUX output
S	Input	1	Clock select input

## Design Entry Method

This design element can be used in schematics.

## For More Information

- See the [Spartan-6 FPGA Clocking Resources User Guide \(UG382\)](#).
- See the [Spartan-6 FPGA Data Sheet: DC and Switching Characteristics \(DS162\)](#).

## BUFGP

### Primitive: Global Buffer for Driving Clocks

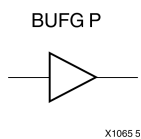

## Introduction

This design element is a primary global buffer that is used to distribute high fan-out clock or control signals throughout in FPGA devices. It is equivalent to an IBUFG driving a BUFG.

This design element provides a low-skew, global resource to internal logic and I/O clock, clock enable, and logic resources. There are some restrictions in using the global buffers for clocking and/or logic. Please see the [Spartan-6 FPGA Clocking Resources User Guide](#) for details.

## Design Entry Method

This design element is only for use in schematics.

## For More Information

See the [Spartan-6 FPGA User Documentation \(User Guides and Data Sheets\)](#).

## BUFH

Primitive: Clock buffer for a single clocking region

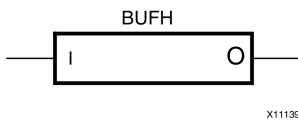

### Introduction

The BUFH primitive is provided to allow instantiation capability to access the HCLK clock buffer resources. The use of this component requires manual placement and special consideration and thus is recommended for more advanced users. Please refer to the [Spartan-6 FPGA Clocking Resources User Guide \(UG382\)](#) for details about using this component.

### Port Descriptions

Port	Direction	Width	Function
I	Input	1	Clock Input
O	Output	1	Clock Output

### Design Entry Method

This design element can be used in schematics.

### For More Information

See the [Spartan-6 FPGA User Documentation \(User Guides and Data Sheets\)](#).

## BUFIO2

### Primitive: Dual Clock Buffer and Strobe Pulse

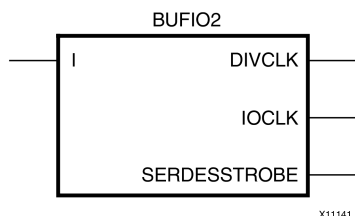

## Introduction

This primitive provides high-speed I/O clocking resources from an off-chip source intended to drive the synchronous I/O resources (ISERDES2, OSERDES2) and associated fabric resources via a BUFG with low skew. Please refer to the [Spartan-6 FPGA Clocking Resources User Guide \(UG382\)](#) for details about using this component.

## Port Descriptions

Port	Direction	Width	Function
DIVCLK	Output	1	Divided clock output
I	Input	1	Clock input
IOCLK	Output	1	Clock output
SERDESSTROBE	Output	1	Output SERDES Strobe (connect to ISERDES/OSERDES)

## Design Entry Method

This design element can be used in schematics.

## Available Attributes

Attribute	Data Type	Allowed Values	Default	Description
DIVIDE	Decimal	1, 3, 4, 5, 6, 7, 8	1	DIVCLK divider
DIVIDE_BYPASS	Boolean	TRUE, FALSE	TRUE	Bypass the divider circuitry
I_INVERT	Boolean	FALSE, TRUE	FALSE	Invert clock
USE_DOUBLER	Boolean	FALSE, TRUE	FALSE	Use doubler circuitry

## For More Information

- See the [Spartan-6 FPGA Clocking Resources User Guide \(UG382\)](#).
- See the [Spartan-6 FPGA Data Sheet: DC and Switching Characteristics \(DS162\)](#).

## BUFIO2\_2CLK

Primitive: Dual Clock Buffer and Strobe Pulse with Differential Input

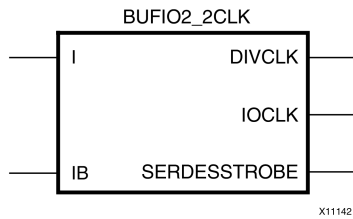

### Introduction

The BUFIO2\_2CLK resource provides high-speed I/O clocking resources from an off-chip source intended to drive the synchronous I/O resources (ISERDES2, OSERDES2) and associated fabric resources via a BUFG with low skew. Please refer to the [Spartan-6 FPGA Clocking Resources User Guide \(UG382\)](#) for details about using this component.

### Design Entry Method

This design element can be used in schematics.

### For More Information

- See the [Spartan-6 FPGA Clocking Resources User Guide \(UG382\)](#).
- See the [Spartan-6 FPGA Data Sheet: DC and Switching Characteristics \(DS162\)](#).

## BUFIO2FB

Primitive: Feedback Clock Buffer

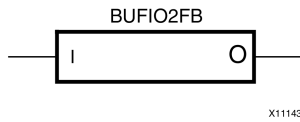

### Introduction

This element is a simple buffer that is delay matched to an associated BUFIO2 which is used for the feedback path for proper phase compensation of the feedback when using a DLL or PLL.

### Port Descriptions

Port	Direction	Width	Function
I	Input	1	Input feedback clock.
O	Output	1	Output feedback clock (Connect to feedback input of DCM/PLL).

### Design Entry Method

This design element can be used in schematics.

### Available Attributes

Attribute	Data Type	Allowed Values	Default	Description
DIVIDE_BYPASS	Boolean	TRUE, FALSE	TRUE	Bypass Divider (TRUE/FALSE) Set the same as associated BUFIO2.

### For More Information

- See the [Spartan-6 FPGA Clocking Resources User Guide \(UG382\)](#).
- See the [Spartan-6 FPGA Data Sheet: DC and Switching Characteristics \(DS162\)](#).

# BUFPLL

## Primitive: PLL Buffer

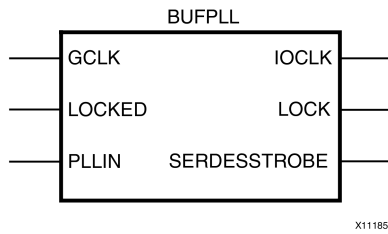

## Introduction

High-speed I/O clock buffer sourced from the PLL component.

## Port Descriptions

Port	Direction	Width	Function
GCLK	Input	1	BUFG Clock Input.
IOCLK	Output	1	Output I/O Clock.
LOCK	Output	1	Synchronized LOCK output.
LOCKED	Input	1	LOCKED Input from PLL.
PLLIN	Input	1	Clock Input from PLL.
SERDESSTROBE	Output	1	SERDES strobe (connect to ISERDES/OSERDES).

## Design Entry Method

This design element can be used in schematics.

## Available Attributes

Attribute	Data Type	Allowed Values	Default	Description
DIVIDE	Integer	1, 2, 3, 4, 5, 6, 7, 8	1	DIVCLK Divider (1-8)
ENABLE_SYNC	Boolean	TRUE, FALSE	TRUE	Enable synchronization between PLL and GCLK (TRUE/FALSE).

## For More Information

- See the [Spartan-6 FPGA Clocking Resources User Guide \(UG382\)](#).
- See the [Spartan-6 FPGA Data Sheet: DC and Switching Characteristics \(DS162\)](#).

## CARRY4

### Primitive: Fast Carry Logic with Look Ahead

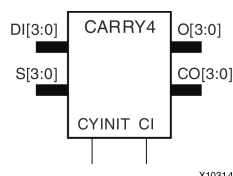

## Introduction

This circuit design represents the fast carry logic for a slice. The carry chain consists of a series of four MUXes and four XORs that connect to the other logic (LUTs) in the slice via dedicated routes to form more complex functions. The fast carry logic is useful for building arithmetic functions like adders, counters, subtractors and add/subs, as well as such other logic functions as wide comparators, address decoders, and some logic gates (specifically, AND and OR).

## Port Descriptions

Port	Direction	Width	Function
O	Output	4	Carry chain XOR general data out
CO	Output	4	Carry-out of each stage of the carry chain
DI	Input	4	Carry-MUX data input
S	Input	4	Carry-MUX select line
CYINIT	Input	1	Carry-in initialization input
CI	Input	1	Carry cascade input

## Design Entry Method

This design element can be used in schematics.

## For More Information

- See the [Spartan-6 FPGA Configurable Logic Block User Guide \(UG384\)](#).
- See the [Spartan-6 FPGA Data Sheet: DC and Switching Characteristics \(DS162\)](#).



# CB16CE

## Macro: 16-Bit Cascadable Binary Counter with Clock Enable and Asynchronous Clear

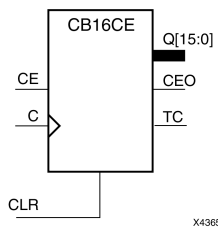

### Introduction

This design element is an asynchronously clearable, cascadable binary counter. The asynchronous clear (CLR) input, when High, overrides all other inputs and forces the Q outputs, terminal count (TC), and clock enable out (CEO) to logic level zero, independent of clock transitions. The Q outputs increment when the clock enable input (CE) is High during the Low-to-High clock (C) transition. The counter ignores clock transitions when CE is Low. The TC output is High when all Q outputs are High.

Create larger counters by connecting the CEO output of each stage to the CE input of the next stage and connecting the C and CLR inputs in parallel. CEO is active (High) when TC and CE are High. The maximum length of the counter is determined by the accumulated CE-to-TC propagation delays versus the clock period. The clock period must be greater than  $n(t_{CE-TC})$ , where  $n$  is the number of stages and the time  $t_{CE-TC}$  is the CE-to-TC propagation delay of each stage. When cascading counters, use the CEO output if the counter uses the CE input or use the TC output if it does not.

This counter is asynchronously cleared, outputs Low, when power is applied. For FPGA devices, power-on conditions are simulated when global set/reset (GSR) is active. GSR defaults to active-High but can be inverted by adding an inverter in front of the GSR input of the appropriate `STARTUP_architecture` symbol.

### Logic Table

Inputs			Outputs		
CLR	CE	C	Qz-Q0	TC	CEO
1	X	X	0	0	0
0	0	X	No change	No change	0
0	1	↑	Inc	TC	CEO

z = bit width - 1  
 $TC = Q_z \cdot Q_{(z-1)} \cdot Q_{(z-2)} \cdot \dots \cdot Q_0$   
 $CEO = TC \cdot CE$

### Design Entry Method

This design element is only for use in schematics.

### For More Information

See the [Spartan-6 FPGA User Documentation \(User Guides and Data Sheets\)](#).



## CB16CLE

### Macro: 16-Bit Loadable Cascadable Binary Counters with Clock Enable and Asynchronous Clear

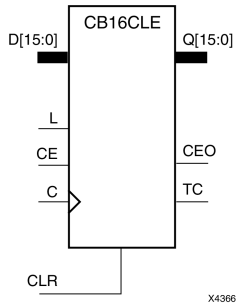

## Introduction

This element is a synchronously loadable, asynchronously clearable, cascadable binary counter. The asynchronous clear (CLR) input, when High, overrides all other inputs and forces the Q outputs, terminal count (TC), and clock enable out (CEO) to logic level zero, independent of clock transitions. The data on the D inputs is loaded into the counter when the load enable input (L) is High during the Low-to-High clock transition, independent of the state of clock enable (CE). The Q outputs increment when CE is High during the Low-to-High clock transition. The counter ignores clock transitions when CE is Low. The TC output is High when all Q outputs are High.

Create larger counters by connecting the CEO output of each stage to the CE input of the next stage and connecting the C, L, and CLR inputs in parallel. CEO is active (High) when TC and CE are High. The maximum length of the counter is determined by the accumulated CE-to-TC propagation delays versus the clock period. The clock period must be greater than  $n(t_{CE-TC})$ , where  $n$  is the number of stages and the time  $t_{CE-TC}$  is the CE-to-TC propagation delay of each stage. When cascading counters, use the CEO output if the counter uses the CE input or use the TC output if it does not.

This counter is asynchronously cleared, outputs Low, when power is applied. For FPGA devices, power-on conditions are simulated when global set/reset (GSR) is active. GSR defaults to active-High but can be inverted by adding an inverter in front of the GSR input of the appropriate `STARTUP_architecture` symbol.

## Logic Table

Inputs					Outputs		
CLR	L	CE	C	Dz-D0	Qz-Q0	TC	CEO
1	X	X	X	X	0	0	0
0	1	X	↑	Dn	Dn	TC	CEO
0	0	0	X	X	No change	No change	0
0	0	1	↑	X	Inc	TC	CEO

$z = \text{bit width} - 1$   
 $TC = Qz \cdot Q(z-1) \cdot Q(z-2) \cdot \dots \cdot Q0$   
 $CEO = TC \cdot CE$

## Design Entry Method

This design element is only for use in schematics.

## For More Information

See the [Spartan-6 FPGA User Documentation \(User Guides and Data Sheets\)](#).

## CB16CLED

Macro: 16-Bit Loadable Cascadable Bidirectional Binary Counters with Clock Enable and Asynchronous Clear

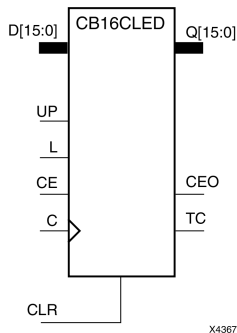

### Introduction

This design element is a synchronously loadable, asynchronously clearable, cascadable, bidirectional binary counter. The asynchronous clear (CLR) input, when High, overrides all other inputs and forces the Q outputs, terminal count (TC), and clock enable out (CEO) to logic level zero, independent of clock transitions. The data on the D inputs is loaded into the counter when the load enable input (L) is High during the Low-to-High clock (C) transition, independent of the state of clock enable (CE). The Q outputs decrement when CE is High and UP is Low during the Low-to-High clock transition. The Q outputs increment when CE and UP are High. The counter ignores clock transitions when CE is Low.

For counting up, the TC output is High when all Q outputs and UP are High. For counting down, the TC output is High when all Q outputs and UP are Low.

Create larger counters by connecting the CEO output of each stage to the CE input of the next stage and connecting the C, UP, L, and CLR inputs in parallel. CEO is active (High) when TC and CE are High. The maximum length of the counter is determined by the accumulated CE-to-TC propagation delays versus the clock period. The clock period must be greater than  $n(t_{CE-TC})$ , where  $n$  is the number of stages and the time  $t_{CE-TC}$  is the CE-to-TC propagation delay of each stage. When cascading counters, use the CEO output if the counter uses the CE input or use the TC output if it does not.

For CPLD parts, see CB2X1, CB4X1, CB8X1, CB16X1 for high-performance cascadable, bidirectional counters.

This counter is asynchronously cleared, outputs Low, when power is applied. For FPGA devices, power-on conditions are simulated when global set/reset (GSR) is active. GSR defaults to active-High but can be inverted by adding an inverter in front of the GSR input of the appropriate `STARTUP_architecture` symbol.

## Logic Table

Inputs						Outputs		
CLR	L	CE	C	UP	Dz-D0	Qz-Q0	TC	CEO
1	X	X	X	X	X	0	0	0
0	1	X	↑	X	Dn	Dn	TC	CEO
0	0	0	X	X	X	No change	No change	0
0	0	1	↑	1	X	Inc	TC	CEO
0	0	1	↑	0	X	Dec	TC	CEO

z = bit width - 1

$$TC = (Qz \cdot Q(z-1) \cdot Q(z-2) \cdot \dots \cdot Q0 \cdot UP) + (Qz \cdot Q(z-1) \cdot Q(z-2) \cdot \dots \cdot Q0 \cdot \overline{UP})$$

$$CEO = TC \cdot CE$$

## Design Entry Method

This design element is only for use in schematics.

## For More Information

See the [Spartan-6 FPGA User Documentation \(User Guides and Data Sheets\)](#).

# CB16RE

## Macro: 16-Bit Cascadable Binary Counter with Clock Enable and Synchronous Reset

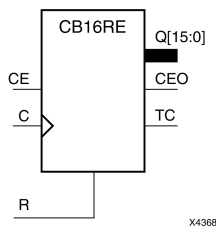

### Introduction

This design element is a synchronous, resettable, cascadable binary counter. The synchronous reset (R), when High, overrides all other inputs and forces the Q outputs, terminal count (TC), and clock enable out (CEO) to zero on the Low-to-High clock transition. The Q outputs increment when the clock enable input (CE) is High during the Low-to-High clock (C) transition. The counter ignores clock transitions when CE is Low. The TC output is High when both Q outputs are High.

Create larger counters by connecting the CEO output of each stage to the CE input of the next stage and connecting the C and R inputs in parallel. CEO is active (High) when TC and CE are High. The maximum length of the counter is determined by the accumulated CE-to-TC propagation delays versus the clock period. The clock period must be greater than  $n (t_{CE-TC})$ , where  $n$  is the number of stages and the time  $t_{CE-TC}$  is the CE-to-TC propagation delay of each stage. When cascading counters, use the CEO output if the counter uses the CE input or use the TC output if it does not.

This counter is asynchronously cleared, outputs Low, when power is applied. For FPGA devices, power-on conditions are simulated when global set/reset (GSR) is active. GSR defaults to active-High but can be inverted by adding an inverter in front of the GSR input of the appropriate `STARTUP_architecture` symbol.

### Logic Table

Inputs			Outputs		
R	CE	C	Qz-Q0	TC	CEO
1	X	↑	0	0	0
0	0	X	No change	No change	0
0	1	↑	Inc	TC	CEO
$z = \text{bit width} - 1$ $TC = Qz \cdot Q(z-1) \cdot Q(z-2) \cdot \dots \cdot Q0$ $CEO = TC \cdot CE$					

### Design Entry Method

This design element is only for use in schematics.

### For More Information

See the [Spartan-6 FPGA User Documentation \(User Guides and Data Sheets\)](#).

## CB2CE

### Macro: 2-Bit Cascadable Binary Counter with Clock Enable and Asynchronous Clear

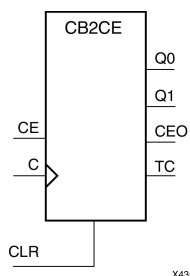

## Introduction

This design element is an asynchronously clearable, cascadable binary counter. The asynchronous clear (CLR) input, when High, overrides all other inputs and forces the Q outputs, terminal count (TC), and clock enable out (CEO) to logic level zero, independent of clock transitions. The Q outputs increment when the clock enable input (CE) is High during the Low-to-High clock (C) transition. The counter ignores clock transitions when CE is Low. The TC output is High when all Q outputs are High.

Create larger counters by connecting the CEO output of each stage to the CE input of the next stage and connecting the C and CLR inputs in parallel. CEO is active (High) when TC and CE are High. The maximum length of the counter is determined by the accumulated CE-to-TC propagation delays versus the clock period. The clock period must be greater than  $n(t_{CE-TC})$ , where  $n$  is the number of stages and the time  $t_{CE-TC}$  is the CE-to-TC propagation delay of each stage. When cascading counters, use the CEO output if the counter uses the CE input or use the TC output if it does not.

This counter is asynchronously cleared, outputs Low, when power is applied. For FPGA devices, power-on conditions are simulated when global set/reset (GSR) is active. GSR defaults to active-High but can be inverted by adding an inverter in front of the GSR input of the appropriate `STARTUP_architecture` symbol.

## Logic Table

Inputs			Outputs		
CLR	CE	C	Qz-Q0	TC	CEO
1	X	X	0	0	0
0	0	X	No change	No change	0
0	1	↑	Inc	TC	CEO
$z = \text{bit width} - 1$ $TC = Qz \cdot Q(z-1) \cdot Q(z-2) \cdot \dots \cdot Q0$ $CEO = TC \cdot CE$					

## Design Entry Method

This design element is only for use in schematics.

## For More Information

See the [Spartan-6 FPGA User Documentation \(User Guides and Data Sheets\)](#).



# CB2CLE

## Macro: 2-Bit Loadable Cascadable Binary Counters with Clock Enable and Asynchronous Clear

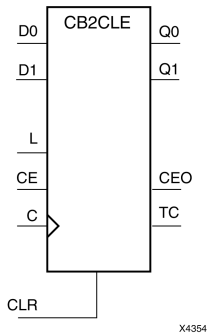

### Introduction

This element is a synchronously loadable, asynchronously clearable, cascadable binary counter. The asynchronous clear (CLR) input, when High, overrides all other inputs and forces the Q outputs, terminal count (TC), and clock enable out (CEO) to logic level zero, independent of clock transitions. The data on the D inputs is loaded into the counter when the load enable input (L) is High during the Low-to-High clock transition, independent of the state of clock enable (CE). The Q outputs increment when CE is High during the Low-to-High clock transition. The counter ignores clock transitions when CE is Low. The TC output is High when all Q outputs are High.

Create larger counters by connecting the CEO output of each stage to the CE input of the next stage and connecting the C, L, and CLR inputs in parallel. CEO is active (High) when TC and CE are High. The maximum length of the counter is determined by the accumulated CE-to-TC propagation delays versus the clock period. The clock period must be greater than  $n(t_{CE-TC})$ , where  $n$  is the number of stages and the time  $t_{CE-TC}$  is the CE-to-TC propagation delay of each stage. When cascading counters, use the CEO output if the counter uses the CE input or use the TC output if it does not.

This counter is asynchronously cleared, outputs Low, when power is applied. For FPGA devices, power-on conditions are simulated when global set/reset (GSR) is active. GSR defaults to active-High but can be inverted by adding an inverter in front of the GSR input of the appropriate `STARTUP_architecture` symbol.

### Logic Table

Inputs					Outputs		
CLR	L	CE	C	Dz-D0	Qz-Q0	TC	CEO
1	X	X	X	X	0	0	0
0	1	X	↑	Dn	Dn	TC	CEO
0	0	0	X	X	No change	No change	0
0	0	1	↑	X	Inc	TC	CEO

z = bit width - 1  
 $TC = Qz \cdot Q(z-1) \cdot Q(z-2) \cdot \dots \cdot Q0$   
 $CEO = TC \cdot CE$

### Design Entry Method

This design element is only for use in schematics.

## For More Information

See the [Spartan-6 FPGA User Documentation \(User Guides and Data Sheets\)](#).

## CB2CLEDD

### Macro: 2-Bit Loadable Cascadable Bidirectional Binary Counters with Clock Enable and Asynchronous Clear

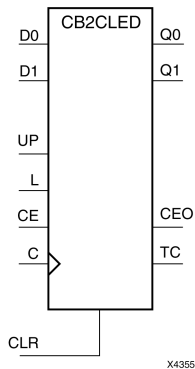

## Introduction

This design element is a synchronously loadable, asynchronously clearable, cascadable, bidirectional binary counter. The asynchronous clear (CLR) input, when High, overrides all other inputs and forces the Q outputs, terminal count (TC), and clock enable out (CEO) to logic level zero, independent of clock transitions. The data on the D inputs is loaded into the counter when the load enable input (L) is High during the Low-to-High clock (C) transition, independent of the state of clock enable (CE). The Q outputs decrement when CE is High and UP is Low during the Low-to-High clock transition. The Q outputs increment when CE and UP are High. The counter ignores clock transitions when CE is Low.

For counting up, the TC output is High when all Q outputs and UP are High. For counting down, the TC output is High when all Q outputs and UP are Low.

Create larger counters by connecting the CEO output of each stage to the CE input of the next stage and connecting the C, UP, L, and CLR inputs in parallel. CEO is active (High) when TC and CE are High. The maximum length of the counter is determined by the accumulated CE-to-TC propagation delays versus the clock period. The clock period must be greater than  $n(t_{CE-TC})$ , where  $n$  is the number of stages and the time  $t_{CE-TC}$  is the CE-to-TC propagation delay of each stage. When cascading counters, use the CEO output if the counter uses the CE input or use the TC output if it does not.

For CPLD parts, see CB2X1, CB4X1, CB8X1, CB16X1 for high-performance cascadable, bidirectional counters.

This counter is asynchronously cleared, outputs Low, when power is applied. For FPGA devices, power-on conditions are simulated when global set/reset (GSR) is active. GSR defaults to active-High but can be inverted by adding an inverter in front of the GSR input of the appropriate `STARTUP_architecture` symbol.

## Logic Table

Inputs						Outputs		
CLR	L	CE	C	UP	Dz-D0	Qz-Q0	TC	CEO
1	X	X	X	X	X	0	0	0
0	1	X	↑	X	Dn	Dn	TC	CEO
0	0	0	X	X	X	No change	No change	0
0	0	1	↑	1	X	Inc	TC	CEO
0	0	1	↑	0	X	Dec	TC	CEO

$z = \text{bit width} - 1$   
 $TC = (Qz \cdot Q(z-1) \cdot Q(z-2) \cdot \dots \cdot Q0 \cdot UP) + (Qz \cdot Q(z-1) \cdot Q(z-2) \cdot \dots \cdot Q0 \cdot \overline{UP})$   
 $CEO = TC \cdot CE$

## Design Entry Method

This design element is only for use in schematics.

## For More Information

See the [Spartan-6 FPGA User Documentation \(User Guides and Data Sheets\)](#).

## CB2RE

### Macro: 2-Bit Cascadable Binary Counter with Clock Enable and Synchronous Reset

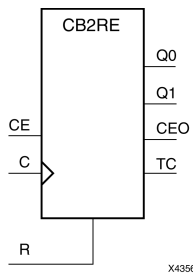

## Introduction

This design element is a synchronous, resettable, cascadable binary counter. The synchronous reset (R), when High, overrides all other inputs and forces the Q outputs, terminal count (TC), and clock enable out (CEO) to zero on the Low-to-High clock transition. The Q outputs increment when the clock enable input (CE) is High during the Low-to-High clock (C) transition. The counter ignores clock transitions when CE is Low. The TC output is High when both Q outputs are High.

Create larger counters by connecting the CEO output of each stage to the CE input of the next stage and connecting the C and R inputs in parallel. CEO is active (High) when TC and CE are High. The maximum length of the counter is determined by the accumulated CE-to-TC propagation delays versus the clock period. The clock period must be greater than  $n (t_{CE-TC})$ , where  $n$  is the number of stages and the time  $t_{CE-TC}$  is the CE-to-TC propagation delay of each stage. When cascading counters, use the CEO output if the counter uses the CE input or use the TC output if it does not.

This counter is asynchronously cleared, outputs Low, when power is applied. For FPGA devices, power-on conditions are simulated when global set/reset (GSR) is active. GSR defaults to active-High but can be inverted by adding an inverter in front of the GSR input of the appropriate `STARTUP_architecture` symbol.

## Logic Table

Inputs			Outputs		
R	CE	C	Qz-Q0	TC	CEO
1	X	↑	0	0	0
0	0	X	No change	No change	0
0	1	↑	Inc	TC	CEO
$z = \text{bit width} - 1$ $TC = Qz \cdot Q(z-1) \cdot Q(z-2) \cdot \dots \cdot Q0$ $CEO = TC \cdot CE$					

## Design Entry Method

This design element is only for use in schematics.

## For More Information

See the [Spartan-6 FPGA User Documentation \(User Guides and Data Sheets\)](#).

## CB4CE

### Macro: 4-Bit Cascadable Binary Counter with Clock Enable and Asynchronous Clear

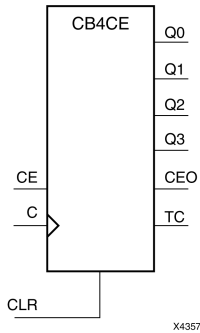

## Introduction

This design element is an asynchronously clearable, cascadable binary counter. The asynchronous clear (CLR) input, when High, overrides all other inputs and forces the Q outputs, terminal count (TC), and clock enable out (CEO) to logic level zero, independent of clock transitions. The Q outputs increment when the clock enable input (CE) is High during the Low-to-High clock (C) transition. The counter ignores clock transitions when CE is Low. The TC output is High when all Q outputs are High.

Create larger counters by connecting the CEO output of each stage to the CE input of the next stage and connecting the C and CLR inputs in parallel. CEO is active (High) when TC and CE are High. The maximum length of the counter is determined by the accumulated CE-to-TC propagation delays versus the clock period. The clock period must be greater than  $n (t_{CE-TC})$ , where  $n$  is the number of stages and the time  $t_{CE-TC}$  is the CE-to-TC propagation delay of each stage. When cascading counters, use the CEO output if the counter uses the CE input or use the TC output if it does not.

This counter is asynchronously cleared, outputs Low, when power is applied. For FPGA devices, power-on conditions are simulated when global set/reset (GSR) is active. GSR defaults to active-High but can be inverted by adding an inverter in front of the GSR input of the appropriate `STARTUP_architecture` symbol.

## Logic Table

Inputs			Outputs		
CLR	CE	C	Qz-Q0	TC	CEO
1	X	X	0	0	0
0	0	X	No change	No change	0
0	1	↑	Inc	TC	CEO

z = bit width - 1  
 $TC = Q_z \cdot Q_{(z-1)} \cdot Q_{(z-2)} \cdot \dots \cdot Q_0$   
 $CEO = TC \cdot CE$

## Design Entry Method

This design element is only for use in schematics.

## For More Information

See the [Spartan-6 FPGA User Documentation \(User Guides and Data Sheets\)](#).

# CB4CLE

## Macro: 4-Bit Loadable Cascadable Binary Counters with Clock Enable and Asynchronous Clear

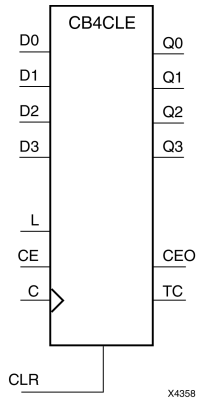

### Introduction

This element is a synchronously loadable, asynchronously clearable, cascadable binary counter. The asynchronous clear (CLR) input, when High, overrides all other inputs and forces the Q outputs, terminal count (TC), and clock enable out (CEO) to logic level zero, independent of clock transitions. The data on the D inputs is loaded into the counter when the load enable input (L) is High during the Low-to-High clock transition, independent of the state of clock enable (CE). The Q outputs increment when CE is High during the Low-to-High clock transition. The counter ignores clock transitions when CE is Low. The TC output is High when all Q outputs are High.

Create larger counters by connecting the CEO output of each stage to the CE input of the next stage and connecting the C, L, and CLR inputs in parallel. CEO is active (High) when TC and CE are High. The maximum length of the counter is determined by the accumulated CE-to-TC propagation delays versus the clock period. The clock period must be greater than  $n(t_{CE-TC})$ , where  $n$  is the number of stages and the time  $t_{CE-TC}$  is the CE-to-TC propagation delay of each stage. When cascading counters, use the CEO output if the counter uses the CE input or use the TC output if it does not.

This counter is asynchronously cleared, outputs Low, when power is applied. For FPGA devices, power-on conditions are simulated when global set/reset (GSR) is active. GSR defaults to active-High but can be inverted by adding an inverter in front of the GSR input of the appropriate *STARTUP\_architecture* symbol.

### Logic Table

Inputs					Outputs		
CLR	L	CE	C	Dz-D0	Qz-Q0	TC	CEO
1	X	X	X	X	0	0	0
0	1	X	↑	Dn	Dn	TC	CEO
0	0	0	X	X	No change	No change	0
0	0	1	↑	X	Inc	TC	CEO

z = bit width - 1  
 $TC = Qz \cdot Q(z-1) \cdot Q(z-2) \cdot \dots \cdot Q0$   
 $CEO = TC \cdot CE$

## Design Entry Method

This design element is only for use in schematics.

## For More Information

See the [Spartan-6 FPGA User Documentation \(User Guides and Data Sheets\)](#).



# CB4CLED

## Macro: 4-Bit Loadable Cascadable Bidirectional Binary Counters with Clock Enable and Asynchronous Clear

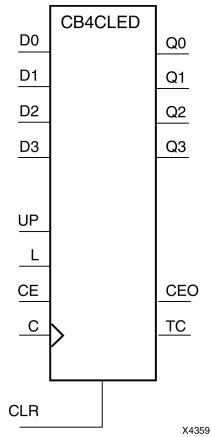

### Introduction

This design element is a synchronously loadable, asynchronously clearable, cascadable, bidirectional binary counter. The asynchronous clear (CLR) input, when High, overrides all other inputs and forces the Q outputs, terminal count (TC), and clock enable out (CEO) to logic level zero, independent of clock transitions. The data on the D inputs is loaded into the counter when the load enable input (L) is High during the Low-to-High clock (C) transition, independent of the state of clock enable (CE). The Q outputs decrement when CE is High and UP is Low during the Low-to-High clock transition. The Q outputs increment when CE and UP are High. The counter ignores clock transitions when CE is Low.

For counting up, the TC output is High when all Q outputs and UP are High. For counting down, the TC output is High when all Q outputs and UP are Low.

Create larger counters by connecting the CEO output of each stage to the CE input of the next stage and connecting the C, UP, L, and CLR inputs in parallel. CEO is active (High) when TC and CE are High. The maximum length of the counter is determined by the accumulated CE-to-TC propagation delays versus the clock period. The clock period must be greater than  $n(t_{CE-TC})$ , where  $n$  is the number of stages and the time  $t_{CE-TC}$  is the CE-to-TC propagation delay of each stage. When cascading counters, use the CEO output if the counter uses the CE input or use the TC output if it does not.

For CPLD parts, see CB2X1, CB4X1, CB8X1, CB16X1 for high-performance cascadable, bidirectional counters.

This counter is asynchronously cleared, outputs Low, when power is applied. For FPGA devices, power-on conditions are simulated when global set/reset (GSR) is active. GSR defaults to active-High but can be inverted by adding an inverter in front of the GSR input of the appropriate `STARTUP_architecture` symbol.

### Logic Table

Inputs						Outputs		
CLR	L	CE	C	UP	Dz-D0	Qz-Q0	TC	CEO
1	X	X	X	X	X	0	0	0
0	1	X	↑	X	Dn	Dn	TC	CEO
0	0	0	X	X	X	No change	No change	0
0	0	1	↑	1	X	Inc	TC	CEO

Inputs						Outputs		
CLR	L	CE	C	UP	Dz-D0	Qz-Q0	TC	CEO
0	0	1	↑	0	X	Dec	TC	CEO
$z = \text{bit width} - 1$ $TC = (Qz \cdot Q(z-1) \cdot Q(z-2) \cdot \dots \cdot Q0 \cdot UP) + (Qz \cdot Q(z-1) \cdot Q(z-2) \cdot \dots \cdot Q0 \cdot UP)$ $CEO = TC \cdot CE$								

## Design Entry Method

This design element is only for use in schematics.

## For More Information

See the [Spartan-6 FPGA User Documentation \(User Guides and Data Sheets\)](#).

## CB4RE

### Macro: 4-Bit Cascadable Binary Counter with Clock Enable and Synchronous Reset

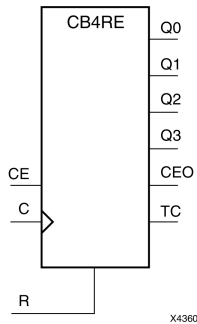

### Introduction

This design element is a synchronous, resettable, cascadable binary counter. The synchronous reset (R), when High, overrides all other inputs and forces the Q outputs, terminal count (TC), and clock enable out (CEO) to zero on the Low-to-High clock transition. The Q outputs increment when the clock enable input (CE) is High during the Low-to-High clock (C) transition. The counter ignores clock transitions when CE is Low. The TC output is High when both Q outputs are High.

Create larger counters by connecting the CEO output of each stage to the CE input of the next stage and connecting the C and R inputs in parallel. CEO is active (High) when TC and CE are High. The maximum length of the counter is determined by the accumulated CE-to-TC propagation delays versus the clock period. The clock period must be greater than  $n (t_{CE-TC})$ , where  $n$  is the number of stages and the time  $t_{CE-TC}$  is the CE-to-TC propagation delay of each stage. When cascading counters, use the CEO output if the counter uses the CE input or use the TC output if it does not.

This counter is asynchronously cleared, outputs Low, when power is applied. For FPGA devices, power-on conditions are simulated when global set/reset (GSR) is active. GSR defaults to active-High but can be inverted by adding an inverter in front of the GSR input of the appropriate `STARTUP_architecture` symbol.

### Logic Table

Inputs			Outputs		
R	CE	C	Qz-Q0	TC	CEO
1	X	↑	0	0	0
0	0	X	No change	No change	0
0	1	↑	Inc	TC	CEO

$z = \text{bit width} - 1$   
 $TC = Q_z \cdot Q_{(z-1)} \cdot Q_{(z-2)} \cdot \dots \cdot Q_0$   
 $CEO = TC \cdot CE$

### Design Entry Method

This design element is only for use in schematics.

### For More Information

See the [Spartan-6 FPGA User Documentation \(User Guides and Data Sheets\)](#).

## CB8CE

### Macro: 8-Bit Cascadable Binary Counter with Clock Enable and Asynchronous Clear

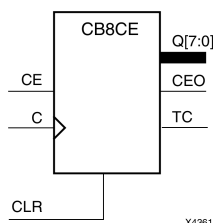

## Introduction

This design element is an asynchronously clearable, cascadable binary counter. The asynchronous clear (CLR) input, when High, overrides all other inputs and forces the Q outputs, terminal count (TC), and clock enable out (CEO) to logic level zero, independent of clock transitions. The Q outputs increment when the clock enable input (CE) is High during the Low-to-High clock (C) transition. The counter ignores clock transitions when CE is Low. The TC output is High when all Q outputs are High.

Create larger counters by connecting the CEO output of each stage to the CE input of the next stage and connecting the C and CLR inputs in parallel. CEO is active (High) when TC and CE are High. The maximum length of the counter is determined by the accumulated CE-to-TC propagation delays versus the clock period. The clock period must be greater than  $n(t_{CE-TC})$ , where  $n$  is the number of stages and the time  $t_{CE-TC}$  is the CE-to-TC propagation delay of each stage. When cascading counters, use the CEO output if the counter uses the CE input or use the TC output if it does not.

This counter is asynchronously cleared, outputs Low, when power is applied. For FPGA devices, power-on conditions are simulated when global set/reset (GSR) is active. GSR defaults to active-High but can be inverted by adding an inverter in front of the GSR input of the appropriate `STARTUP_architecture` symbol.

## Logic Table

Inputs			Outputs		
CLR	CE	C	Qz-Q0	TC	CEO
1	X	X	0	0	0
0	0	X	No change	No change	0
0	1	↑	Inc	TC	CEO

z = bit width - 1  
 $TC = Q_z \cdot Q_{(z-1)} \cdot Q_{(z-2)} \cdot \dots \cdot Q_0$   
 $CEO = TC \cdot CE$

## Design Entry Method

This design element is only for use in schematics.

## For More Information

See the [Spartan-6 FPGA User Documentation \(User Guides and Data Sheets\)](#).



## CB8CLE

### Macro: 8-Bit Loadable Cascadable Binary Counters with Clock Enable and Asynchronous Clear

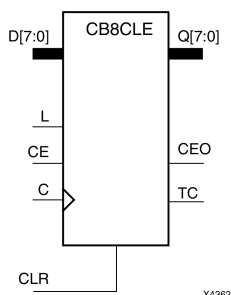

## Introduction

This element is a synchronously loadable, asynchronously clearable, cascadable binary counter. The asynchronous clear (CLR) input, when High, overrides all other inputs and forces the Q outputs, terminal count (TC), and clock enable out (CEO) to logic level zero, independent of clock transitions. The data on the D inputs is loaded into the counter when the load enable input (L) is High during the Low-to-High clock transition, independent of the state of clock enable (CE). The Q outputs increment when CE is High during the Low-to-High clock transition. The counter ignores clock transitions when CE is Low. The TC output is High when all Q outputs are High.

Create larger counters by connecting the CEO output of each stage to the CE input of the next stage and connecting the C, L, and CLR inputs in parallel. CEO is active (High) when TC and CE are High. The maximum length of the counter is determined by the accumulated CE-to-TC propagation delays versus the clock period. The clock period must be greater than  $n(t_{CE-TC})$ , where  $n$  is the number of stages and the time  $t_{CE-TC}$  is the CE-to-TC propagation delay of each stage. When cascading counters, use the CEO output if the counter uses the CE input or use the TC output if it does not.

This counter is asynchronously cleared, outputs Low, when power is applied. For FPGA devices, power-on conditions are simulated when global set/reset (GSR) is active. GSR defaults to active-High but can be inverted by adding an inverter in front of the GSR input of the appropriate `STARTUP_architecture` symbol.

## Logic Table

Inputs					Outputs		
CLR	L	CE	C	Dz-D0	Qz-Q0	TC	CEO
1	X	X	X	X	0	0	0
0	1	X	↑	Dn	Dn	TC	CEO
0	0	0	X	X	No change	No change	0
0	0	1	↑	X	Inc	TC	CEO

z = bit width - 1  
 $TC = Qz \cdot Q(z-1) \cdot Q(z-2) \cdot \dots \cdot Q0$   
 $CEO = TC \cdot CE$

## Design Entry Method

This design element is only for use in schematics.

## For More Information

See the [Spartan-6 FPGA User Documentation \(User Guides and Data Sheets\)](#).

## CB8CLED

Macro: 8-Bit Loadable Cascadable Bidirectional Binary Counters with Clock Enable and Asynchronous Clear

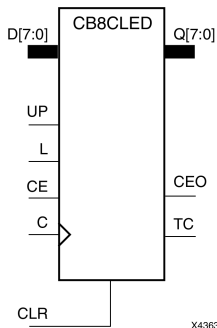

### Introduction

This design element is a synchronously loadable, asynchronously clearable, cascadable, bidirectional binary counter. The asynchronous clear (CLR) input, when High, overrides all other inputs and forces the Q outputs, terminal count (TC), and clock enable out (CEO) to logic level zero, independent of clock transitions. The data on the D inputs is loaded into the counter when the load enable input (L) is High during the Low-to-High clock (C) transition, independent of the state of clock enable (CE). The Q outputs decrement when CE is High and UP is Low during the Low-to-High clock transition. The Q outputs increment when CE and UP are High. The counter ignores clock transitions when CE is Low.

For counting up, the TC output is High when all Q outputs and UP are High. For counting down, the TC output is High when all Q outputs and UP are Low.

Create larger counters by connecting the CEO output of each stage to the CE input of the next stage and connecting the C, UP, L, and CLR inputs in parallel. CEO is active (High) when TC and CE are High. The maximum length of the counter is determined by the accumulated CE-to-TC propagation delays versus the clock period. The clock period must be greater than  $n(t_{CE-TC})$ , where  $n$  is the number of stages and the time  $t_{CE-TC}$  is the CE-to-TC propagation delay of each stage. When cascading counters, use the CEO output if the counter uses the CE input or use the TC output if it does not.

For CPLD parts, see CB2X1, CB4X1, CB8X1, CB16X1 for high-performance cascadable, bidirectional counters.

This counter is asynchronously cleared, outputs Low, when power is applied. For FPGA devices, power-on conditions are simulated when global set/reset (GSR) is active. GSR defaults to active-High but can be inverted by adding an inverter in front of the GSR input of the appropriate *STARTUP\_architecture* symbol.



## Logic Table

Inputs						Outputs		
CLR	L	CE	C	UP	Dz-D0	Qz-Q0	TC	CEO
1	X	X	X	X	X	0	0	0
0	1	X	↑	X	Dn	Dn	TC	CEO
0	0	0	X	X	X	No change	No change	0
0	0	1	↑	1	X	Inc	TC	CEO
0	0	1	↑	0	X	Dec	TC	CEO

z = bit width - 1

$$TC = (Qz \cdot Q(z-1) \cdot Q(z-2) \cdot \dots \cdot Q0 \cdot UP) + (Qz \cdot Q(z-1) \cdot Q(z-2) \cdot \dots \cdot Q0 \cdot \overline{UP})$$

$$CEO = TC \cdot CE$$

## Design Entry Method

This design element is only for use in schematics.

## For More Information

See the [Spartan-6 FPGA User Documentation \(User Guides and Data Sheets\)](#).

## CB8RE

### Macro: 8-Bit Cascadable Binary Counter with Clock Enable and Synchronous Reset

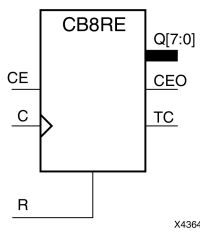

## Introduction

This design element is a synchronous, resettable, cascadable binary counter. The synchronous reset (R), when High, overrides all other inputs and forces the Q outputs, terminal count (TC), and clock enable out (CEO) to zero on the Low-to-High clock transition. The Q outputs increment when the clock enable input (CE) is High during the Low-to-High clock (C) transition. The counter ignores clock transitions when CE is Low. The TC output is High when both Q outputs are High.

Create larger counters by connecting the CEO output of each stage to the CE input of the next stage and connecting the C and R inputs in parallel. CEO is active (High) when TC and CE are High. The maximum length of the counter is determined by the accumulated CE-to-TC propagation delays versus the clock period. The clock period must be greater than  $n (t_{CE-TC})$ , where  $n$  is the number of stages and the time  $t_{CE-TC}$  is the CE-to-TC propagation delay of each stage. When cascading counters, use the CEO output if the counter uses the CE input or use the TC output if it does not.

This counter is asynchronously cleared, outputs Low, when power is applied. For FPGA devices, power-on conditions are simulated when global set/reset (GSR) is active. GSR defaults to active-High but can be inverted by adding an inverter in front of the GSR input of the appropriate `STARTUP_architecture` symbol.

## Logic Table

Inputs			Outputs		
R	CE	C	Qz-Q0	TC	CEO
1	X	↑	0	0	0
0	0	X	No change	No change	0
0	1	↑	Inc	TC	CEO

z = bit width - 1  
 $TC = Qz \cdot Q(z-1) \cdot Q(z-2) \cdot \dots \cdot Q0$   
 $CEO = TC \cdot CE$

## Design Entry Method

This design element is only for use in schematics.

## For More Information

See the [Spartan-6 FPGA User Documentation \(User Guides and Data Sheets\)](#).

# CC16CE

## Macro: 16-Bit Cascadable Binary Counter with Clock Enable and Asynchronous Clear

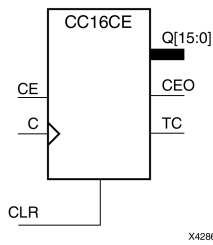

### Introduction

This design element is an asynchronously clearable, cascadable binary counter. It is implemented using carry logic with relative location constraints to ensure efficient logic placement. The asynchronous clear (CLR) is the highest priority input. When CLR is High, all other inputs are ignored; the Q outputs, terminal count (TC), and clock enable out (CEO) go to logic level zero, independent of clock transitions. The Q outputs increment when the clock enable input (CE) is High during the Low-to-High clock (C) transition. The counter ignores clock transitions when CE is Low. The TC output is High when all Q outputs are High.

Create larger counters by connecting the CEO output of each stage to the CE input of the next stage and connecting the C and CLR inputs in parallel. CEO is active (High) when TC and CE are High. The maximum length of the counter is determined by the accumulated CE-to-TC propagation delays versus the clock period. The clock period must be greater than  $n(t_{CE-TC})$ , where  $n$  is the number of stages and the time  $t_{CE-TC}$  is the CE-to-TC propagation delay of each stage. When cascading counters, use the CEO output if the counter uses the CE input or use the TC output if it does not.

This counter is asynchronously cleared, outputs Low, when power is applied. For FPGA devices, power-on conditions are simulated when global set/reset (GSR) is active. GSR defaults to active-High but can be inverted by adding an inverter in front of the GSR input of the appropriate *STARTUP\_architecture* symbol.

### Logic Table

Inputs			Outputs		
CLR	CE	C	Qz-Q0	TC	CEO
1	X	X	0	0	0
0	0	X	No change	No change	0
0	1	↑	Inc	TC	CEO

z = bit width - 1  
 $TC = Qz \cdot Q(z-1) \cdot Q(z-2) \cdot \dots \cdot Q0$   
 $CEO = TC \cdot CE$

### Design Entry Method

This design element is only for use in schematics.

### For More Information

See the [Spartan-6 FPGA User Documentation \(User Guides and Data Sheets\)](#).

## CC16CLE

### Macro: 16-Bit Loadable Cascadable Binary Counter with Clock Enable and Asynchronous Clear

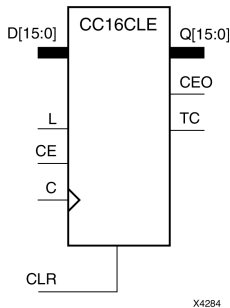

## Introduction

This design element is a synchronously loadable, asynchronously clearable, cascadable binary counter. It is implemented using carry logic with relative location constraints to ensure efficient logic placement. The asynchronous clear (CLR) is the highest priority input. When CLR is High, all other inputs are ignored; the Q outputs, terminal count (TC), and clock enable out (CEO) go to logic level zero, independent of clock transitions. The data on the D inputs is loaded into the counter when the load enable input (L) is High during the Low-to-High clock (C) transition, independent of the state of clock enable (CE). The Q outputs increment when CE is High during the Low-to-High clock transition. The counter ignores clock transitions when CE is Low. The TC output is High when all Q outputs are High.

Create larger counters by connecting the CEO output of each stage to the CE input of the next stage and connecting the C, L, and CLR inputs in parallel. CEO is active (High) when TC and CE are High. The maximum length of the counter is determined by the accumulated CE-to-TC propagation delays versus the clock period. The clock period must be greater than  $n(t_{CE-TC})$ , where  $n$  is the number of stages and the time  $t_{CE-TC}$  is the CE-to-TC propagation delay of each stage. When cascading counters, use the CEO output if the counter uses the CE input or use the TC output if it does not.

This counter is asynchronously cleared, outputs Low, when power is applied. For FPGA devices, power-on conditions are simulated when global set/reset (GSR) is active. GSR defaults to active-High but can be inverted by adding an inverter in front of the GSR input of the appropriate `STARTUP_architecture` symbol.

## Logic Table

Inputs					Outputs		
CLR	L	CE	C	Dz-D0	Qz-Q0	TC	CEO
1	X	X	X	X	0	0	0
0	1	X	↑	Dn	Dn	TC	CEO
0	0	0	X	X	No change	No change	0
0	0	1	↑	X	Inc	TC	CEO

z = bit width - 1  
 $TC = Qz \cdot Q(z-1) \cdot Q(z-2) \cdot \dots \cdot Q0$   
 $CEO = TC \cdot CE$

## Design Entry Method

This design element is only for use in schematics.

## For More Information

See the [Spartan-6 FPGA User Documentation \(User Guides and Data Sheets\)](#).

## CC16CLED

Macro: 16-Bit Loadable Cascadable Bidirectional Binary Counter with Clock Enable and Asynchronous Clear

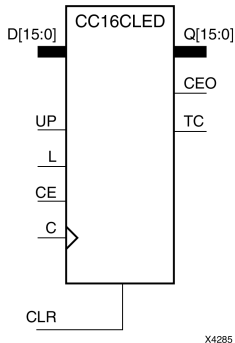

### Introduction

This design element is a synchronously loadable, asynchronously clearable, cascadable, bidirectional binary counter. It is implemented using carry logic with relative location constraints, which assures most efficient logic placement. The asynchronous clear (CLR) is the highest priority input. When CLR is High, all other inputs are ignored; the Q outputs, terminal count (TC), and clock enable out (CEO) go to logic level zero, independent of clock transitions. The data on the D inputs is loaded into the counter when the load enable input (L) is High during the Low-to-High clock (C) transition, independent of the state of clock enable (CE). The Q outputs decrement when CE is High and UP is Low during the Low-to-High clock transition. The Q outputs increment when CE and UP are High. The counter ignores clock transitions when CE is Low.

For counting up, the TC output is High when all Q outputs and UP are High. For counting down, the TC output is High when all Q outputs and UP are Low.

Create larger counters by connecting the CEO output of each stage to the CE input of the next stage and connecting the C, UP, L, and CLR inputs in parallel. CEO is active (High) when TC and CE are High. The maximum length of the counter is determined by the accumulated CE-to-TC propagation delays versus the clock period. The clock period must be greater than  $n (t_{CE-TC})$ , where  $n$  is the number of stages and the time  $t_{CE-TC}$  is the CE-to-TC propagation delay of each stage. When cascading counters, use the CEO output if the counter uses the CE input or use the TC output if it does not.

This counter is asynchronously cleared, outputs Low, when power is applied. For FPGA devices, power-on conditions are simulated when global set/reset (GSR) is active. GSR defaults to active-High but can be inverted by adding an inverter in front of the GSR input of the appropriate STARTUP\_ *architecture* symbol.

## Logic Table

Inputs						Outputs		
CLR	L	CE	C	UP	Dz-D0	Qz-Q0	TC	CEO
1	X	X	X	X	X	0	0	0
0	1	X	↑	X	Dn	Dn	TC	CEO
0	0	0	X	X	X	No change	No change	0
0	0	1	↑	1	X	Inc	TC	CEO
0	0	1	↑	0	X	Dec	TC	CEO

z = bit width - 1

$$TC = (Qz \cdot Q(z-1) \cdot Q(z-2) \cdot \dots \cdot Q0 \cdot UP) + (Qz \cdot Q(z-1) \cdot Q(z-2) \cdot \dots \cdot Q0 \cdot \overline{UP})$$

$$CEO = TC \cdot CE$$

## Design Entry Method

This design element is only for use in schematics.

## For More Information

See the [Spartan-6 FPGA User Documentation \(User Guides and Data Sheets\)](#).

## CC16RE

### Macro: 16-Bit Cascadable Binary Counter with Clock Enable and Synchronous Reset

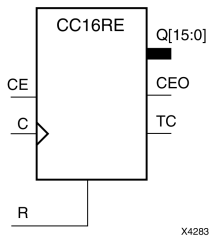

## Introduction

This design element is a synchronous resettable, cascadable binary counter. These counters are implemented using carry logic with relative location constraints to ensure efficient logic placement. The synchronous reset (R) is the highest priority input. When R is High, all other inputs are ignored; the Q outputs, terminal count (TC), and clock enable out (CEO) go to logic level zero on the Low-to-High clock (C) transition. The Q outputs increment when the clock enable input (CE) is High during the Low-to-High clock transition. The counter ignores clock transitions when CE is Low. The TC output is High when all Q outputs and CE are High.

Create larger counters by connecting the CEO output of each stage to the CE input of the next stage and connecting the C and R inputs in parallel. CEO is active (High) when TC and CE are High. The maximum length of the counter is determined by the accumulated CE-to-TC propagation delays versus the clock period. The clock period must be greater than  $n (t_{CE-TC})$ , where  $n$  is the number of stages and the time  $t_{CE-TC}$  is the CE-to-TC propagation delay of each stage. When cascading counters, use the CEO output if the counter uses the CE input or use the TC output if it does not.

This counter is asynchronously cleared, outputs Low, when power is applied. For FPGA devices, power-on conditions are simulated when global set/reset (GSR) is active. GSR defaults to active-High but can be inverted by adding an inverter in front of the GSR input of the appropriate `STARTUP_architecture` symbol.

## Logic Table

Inputs			Outputs		
R	CE	C	Q <sub>z</sub> -Q <sub>0</sub>	TC	CEO
1	X	↑	0	0	0
0	0	X	No change	No change	0
0	1	↑	Inc	TC	CEO
$z = \text{bit width} - 1$ $TC = Q_z \cdot Q_{(z-1)} \cdot Q_{(z-2)} \cdot \dots \cdot Q_0$ $CEO = TC \cdot CE$					

## Design Entry Method

This design element is only for use in schematics.

## For More Information

See the [Spartan-6 FPGA User Documentation \(User Guides and Data Sheets\)](#).



## CC8CE

### Macro: 8-Bit Cascadable Binary Counter with Clock Enable and Asynchronous Clear

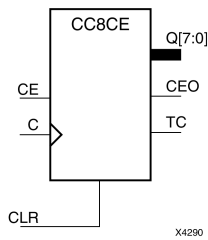

## Introduction

This design element is an asynchronously clearable, cascadable binary counter. It is implemented using carry logic with relative location constraints to ensure efficient logic placement. The asynchronous clear (CLR) is the highest priority input. When CLR is High, all other inputs are ignored; the Q outputs, terminal count (TC), and clock enable out (CEO) go to logic level zero, independent of clock transitions. The Q outputs increment when the clock enable input (CE) is High during the Low-to-High clock (C) transition. The counter ignores clock transitions when CE is Low. The TC output is High when all Q outputs are High.

Create larger counters by connecting the CEO output of each stage to the CE input of the next stage and connecting the C and CLR inputs in parallel. CEO is active (High) when TC and CE are High. The maximum length of the counter is determined by the accumulated CE-to-TC propagation delays versus the clock period. The clock period must be greater than  $n(t_{CE-TC})$ , where  $n$  is the number of stages and the time  $t_{CE-TC}$  is the CE-to-TC propagation delay of each stage. When cascading counters, use the CEO output if the counter uses the CE input or use the TC output if it does not.

This counter is asynchronously cleared, outputs Low, when power is applied. For FPGA devices, power-on conditions are simulated when global set/reset (GSR) is active. GSR defaults to active-High but can be inverted by adding an inverter in front of the GSR input of the appropriate `STARTUP_architecture` symbol.

## Logic Table

Inputs			Outputs		
CLR	CE	C	Q <sub>z</sub> -Q <sub>0</sub>	TC	CEO
1	X	X	0	0	0
0	0	X	No change	No change	0
0	1	↑	Inc	TC	CEO
$z = \text{bit width} - 1$ $TC = Q_z \cdot Q_{(z-1)} \cdot Q_{(z-2)} \cdot \dots \cdot Q_0$ $CEO = TC \cdot CE$					

## Design Entry Method

This design element is only for use in schematics.

## For More Information

See the [Spartan-6 FPGA User Documentation \(User Guides and Data Sheets\)](#).

## CC8CLE

### Macro: 8-Bit Loadable Cascadable Binary Counter with Clock Enable and Asynchronous Clear

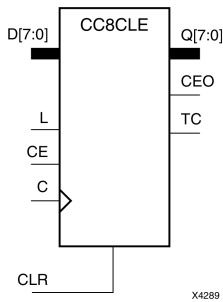

## Introduction

This design element is a synchronously loadable, asynchronously clearable, cascadable binary counter. It is implemented using carry logic with relative location constraints to ensure efficient logic placement. The asynchronous clear (CLR) is the highest priority input. When CLR is High, all other inputs are ignored; the Q outputs, terminal count (TC), and clock enable out (CEO) go to logic level zero, independent of clock transitions. The data on the D inputs is loaded into the counter when the load enable input (L) is High during the Low-to-High clock (C) transition, independent of the state of clock enable (CE). The Q outputs increment when CE is High during the Low-to-High clock transition. The counter ignores clock transitions when CE is Low. The TC output is High when all Q outputs are High.

Create larger counters by connecting the CEO output of each stage to the CE input of the next stage and connecting the C, L, and CLR inputs in parallel. CEO is active (High) when TC and CE are High. The maximum length of the counter is determined by the accumulated CE-to-TC propagation delays versus the clock period. The clock period must be greater than  $n(t_{CE-TC})$ , where  $n$  is the number of stages and the time  $t_{CE-TC}$  is the CE-to-TC propagation delay of each stage. When cascading counters, use the CEO output if the counter uses the CE input or use the TC output if it does not.

This counter is asynchronously cleared, outputs Low, when power is applied. For FPGA devices, power-on conditions are simulated when global set/reset (GSR) is active. GSR defaults to active-High but can be inverted by adding an inverter in front of the GSR input of the appropriate `STARTUP_architecture` symbol.

## Logic Table

Inputs					Outputs		
CLR	L	CE	C	Dz-D0	Qz-Q0	TC	CEO
1	X	X	X	X	0	0	0
0	1	X	↑	Dn	Dn	TC	CEO
0	0	0	X	X	No change	No change	0
0	0	1	↑	X	Inc	TC	CEO

z = bit width - 1  
 $TC = Qz \cdot Q(z-1) \cdot Q(z-2) \cdot \dots \cdot Q0$   
 $CEO = TC \cdot CE$

## Design Entry Method

This design element is only for use in schematics.

## For More Information

See the [Spartan-6 FPGA User Documentation \(User Guides and Data Sheets\)](#).

## CC8CLED

Macro: 8-Bit Loadable Cascadable Bidirectional Binary Counter with Clock Enable and Asynchronous Clear

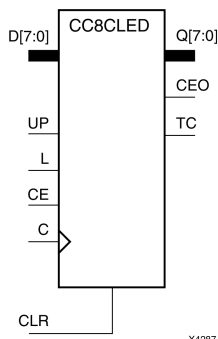

### Introduction

This design element is a synchronously loadable, asynchronously clearable, cascadable, bidirectional binary counter. It is implemented using carry logic with relative location constraints, which assures most efficient logic placement. The asynchronous clear (CLR) is the highest priority input. When CLR is High, all other inputs are ignored; the Q outputs, terminal count (TC), and clock enable out (CEO) go to logic level zero, independent of clock transitions. The data on the D inputs is loaded into the counter when the load enable input (L) is High during the Low-to-High clock (C) transition, independent of the state of clock enable (CE). The Q outputs decrement when CE is High and UP is Low during the Low-to-High clock transition. The Q outputs increment when CE and UP are High. The counter ignores clock transitions when CE is Low.

For counting up, the TC output is High when all Q outputs and UP are High. For counting down, the TC output is High when all Q outputs and UP are Low.

Create larger counters by connecting the CEO output of each stage to the CE input of the next stage and connecting the C, UP, L, and CLR inputs in parallel. CEO is active (High) when TC and CE are High. The maximum length of the counter is determined by the accumulated CE-to-TC propagation delays versus the clock period. The clock period must be greater than  $n (t_{CE-TC})$ , where  $n$  is the number of stages and the time  $t_{CE-TC}$  is the CE-to-TC propagation delay of each stage. When cascading counters, use the CEO output if the counter uses the CE input or use the TC output if it does not.

This counter is asynchronously cleared, outputs Low, when power is applied. For FPGA devices, power-on conditions are simulated when global set/reset (GSR) is active. GSR defaults to active-High but can be inverted by adding an inverter in front of the GSR input of the appropriate `STARTUP_architecture` symbol.

## Logic Table

Inputs						Outputs		
CLR	L	CE	C	UP	Dz-D0	Qz-Q0	TC	CEO
1	X	X	X	X	X	0	0	0
0	1	X	↑	X	Dn	Dn	TC	CEO
0	0	0	X	X	X	No change	No change	0
0	0	1	↑	1	X	Inc	TC	CEO
0	0	1	↑	0	X	Dec	TC	CEO

z = bit width - 1

$$TC = (Qz \cdot Q(z-1) \cdot Q(z-2) \cdot \dots \cdot Q0 \cdot UP) + (Qz \cdot Q(z-1) \cdot Q(z-2) \cdot \dots \cdot Q0 \cdot \overline{UP})$$

$$CEO = TC \cdot CE$$

## Design Entry Method

This design element is only for use in schematics.

## For More Information

See the [Spartan-6 FPGA User Documentation \(User Guides and Data Sheets\)](#).

## CC8RE

### Macro: 8-Bit Cascadable Binary Counter with Clock Enable and Synchronous Reset

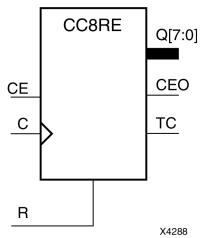

## Introduction

This design element is a synchronous resettable, cascadable binary counter. These counters are implemented using carry logic with relative location constraints to ensure efficient logic placement. The synchronous reset (R) is the highest priority input. When R is High, all other inputs are ignored; the Q outputs, terminal count (TC), and clock enable out (CEO) go to logic level zero on the Low-to-High clock (C) transition. The Q outputs increment when the clock enable input (CE) is High during the Low-to-High clock transition. The counter ignores clock transitions when CE is Low. The TC output is High when all Q outputs and CE are High.

Create larger counters by connecting the CEO output of each stage to the CE input of the next stage and connecting the C and R inputs in parallel. CEO is active (High) when TC and CE are High. The maximum length of the counter is determined by the accumulated CE-to-TC propagation delays versus the clock period. The clock period must be greater than  $n (t_{CE-TC})$ , where  $n$  is the number of stages and the time  $t_{CE-TC}$  is the CE-to-TC propagation delay of each stage. When cascading counters, use the CEO output if the counter uses the CE input or use the TC output if it does not.

This counter is asynchronously cleared, outputs Low, when power is applied. For FPGA devices, power-on conditions are simulated when global set/reset (GSR) is active. GSR defaults to active-High but can be inverted by adding an inverter in front of the GSR input of the appropriate `STARTUP_architecture` symbol.

## Logic Table

Inputs			Outputs		
R	CE	C	Q <sub>z</sub> -Q <sub>0</sub>	TC	CEO
1	X	↑	0	0	0
0	0	X	No change	No change	0
0	1	↑	Inc	TC	CEO
$z = \text{bit width} - 1$ $TC = Q_z \cdot Q_{(z-1)} \cdot Q_{(z-2)} \cdot \dots \cdot Q_0$ $CEO = TC \cdot CE$					

## Design Entry Method

This design element is only for use in schematics.

## For More Information

See the [Spartan-6 FPGA User Documentation \(User Guides and Data Sheets\)](#).

# CD4CE

## Macro: 4-Bit Cascadable BCD Counter with Clock Enable and Asynchronous Clear

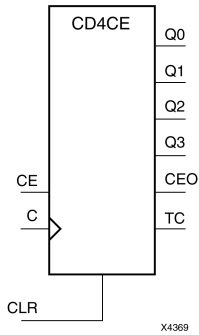

### Introduction

CD4CE is a 4-bit (stage), asynchronous clearable, cascadable binary-coded-decimal (BCD) counter. The asynchronous clear input (CLR) is the highest priority input. When CLR is High, all other inputs are ignored; the Q outputs, terminal count (TC), and clock enable out (CEO) go to logic level zero, independent of clock transitions. The Q outputs increment when clock enable (CE) is High during the Low-to-High clock (C) transition. The counter ignores clock transitions when CE is Low. The TC output is High when Q3 and Q0 are High and Q2 and Q1 are Low.

The counter recovers from any of six possible illegal states and returns to a normal count sequence within two clock cycles for Xilinx® devices, as shown in the following state diagram:

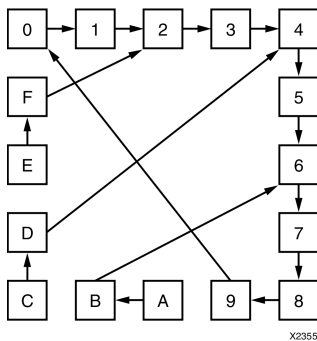

Create larger counters by connecting the CEO output of each stage to the CE input of the next stage and connecting the C and CLR inputs in parallel. CEO is active (High) when TC and CE are High. The maximum length of the counter is determined by the accumulated CE-to-TC propagation delays versus the clock period. The clock period must be greater than  $n(t_{CE-TC})$ , where  $n$  is the number of stages and the time  $t_{CE-TC}$  is the CE-to-TC propagation delay of each stage. When cascading counters, use the CEO output if the counter uses the CE input or use the TC output if it does not.

This counter is asynchronously cleared, outputs Low, when power is applied. For FPGA devices, power-on conditions are simulated when global set/reset (GSR) is active. GSR defaults to active-High but can be inverted by adding an inverter in front of the GSR input of the appropriate `STARTUP_architecture` symbol.

## Logic Table

Inputs			Outputs					
CLR	CE	C	Q3	Q2	Q1	Q0	TC	CEO
1	X	X	0	0	0	0	0	0
0	1	↑	Inc	Inc	Inc	Inc	TC	CEO
0	0	X	No Change	No Change	No Change	No Change	TC	0
0	1	X	1	0	0	1	1	1

$TC = Q3 \cdot !Q2 \cdot !Q1 \cdot Q0$   
 $CEO = TC \cdot CE$

## Design Entry Method

This design element is only for use in schematics.

## For More Information

See the [Spartan-6 FPGA User Documentation \(User Guides and Data Sheets\)](#).



# CD4CLE

## Macro: 4-Bit Loadable Cascadable BCD Counter with Clock Enable and Asynchronous Clear

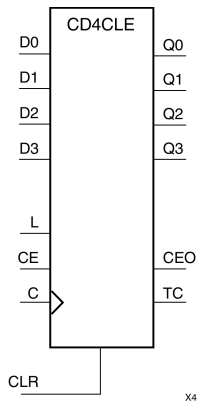

### Introduction

CD4CLE is a 4-bit (stage), synchronously loadable, asynchronously clearable, binarycoded- decimal (BCD) counter. The asynchronous clear input (CLR) is the highest priority input. When (CLR) is High, all other inputs are ignored; the (Q) outputs, terminal count (TC), and clock enable out (CEO) go to logic level zero, independent of clock transitions. The data on the (D) inputs is loaded into the counter when the load enable input (L) is High during the Low-to-High clock (C) transition. The (Q) outputs increment when clock enable input (CE) is High during the Low- to-High clock transition. The counter ignores clock transitions when (CE) is Low. The (TC) output is High when Q3 and Q0 are High and Q2 and Q1 are Low.

The counter recovers from any of six possible illegal states and returns to a normal count sequence within two clock cycles for Xilinx® devices, as shown in the following state diagram:

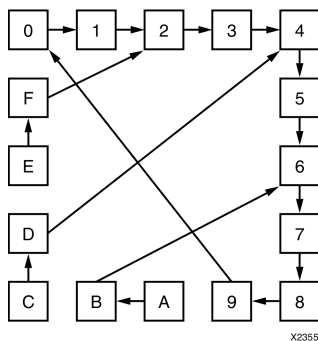

Create larger counters by connecting the CEO output of each stage to the CE input of the next stage and connecting the C, L, and CLR inputs in parallel. CEO is active (High) when TC and CE are High. The maximum length of the counter is determined by the accumulated CE-to-TC propagation delays versus the clock period. The clock period must be greater than  $n(t_{CE-TC})$ , where  $n$  is the number of stages and the time  $t_{CE-TC}$  is the CE-to-TC propagation delay of each stage. When cascading counters, use the CEO output if the counter uses the CE input or use the TC output if it does not.

This counter is asynchronously cleared, outputs Low, when power is applied. For FPGA devices, power-on conditions are simulated when global set/reset (GSR) is active. GSR defaults to active-High but can be inverted by adding an inverter in front of the GSR input of the appropriate `STARTUP_architecture` symbol.

## Logic Table

Inputs					Outputs					
CLR	L	CE	D3 : D0	C	Q3	Q2	Q1	Q0	TC	CEO
1	X	X	X	X	0	0	0	0	0	0
0	1	X	D3 : D0	↑	D3	D2	D1	D0	TC	CEO
0	0	1	X	↑	Inc	Inc	Inc	Inc	TC	CEO
0	0	0	X	X	No Change	No Change	No Change	No Change	TC	0
0	0	1	X	X	1	0	0	1	1	1

$TC = Q3 \cdot !Q2 \cdot !Q1 \cdot Q0$   
 $CEO = TC \cdot CE$

## Design Entry Method

This design element is only for use in schematics.

## For More Information

See the [Spartan-6 FPGA User Documentation \(User Guides and Data Sheets\)](#).

# CD4RE

## Macro: 4-Bit Cascadable BCD Counter with Clock Enable and Synchronous Reset

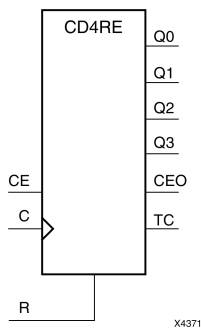

### Introduction

CD4RE is a 4-bit (stage), synchronous resettable, cascadable binary-coded-decimal (BCD) counter. The synchronous reset input (R) is the highest priority input. When (R) is High, all other inputs are ignored; the (Q) outputs, terminal count (TC), and clock enable out (CEO) go to logic level zero on the Low-to-High clock (C) transition. The (Q) outputs increment when the clock enable input (CE) is High during the Low-to-High clock transition. The counter ignores clock transitions when (CE) is Low. The (TC) output is High when Q3 and Q0 are High and Q2 and Q1 are Low.

The counter recovers from any of six possible illegal states and returns to a normal count sequence within two clock cycles for Xilinx® devices, as shown in the following state diagram:

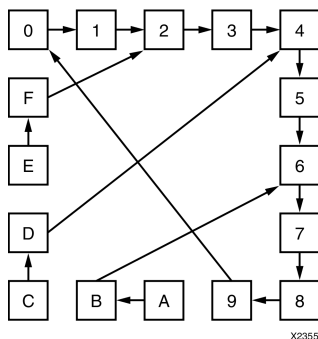

Create larger counters by connecting the CEO output of each stage to the CE input of the next stage and connecting the C and R inputs in parallel. CEO is active (High) when TC and CE are High. The maximum length of the counter is determined by the accumulated CE-to-TC propagation delays versus the clock period. The clock period must be greater than  $n(t_{CE-TC})$ , where  $n$  is the number of stages and the time  $t_{CE-TC}$  is the CE-to-TC propagation delay of each stage. When cascading counters, use the CEO output if the counter uses the CE input or use the TC output if it does not.

This counter is asynchronously cleared, outputs Low, when power is applied. For FPGA devices, power-on conditions are simulated when global set/reset (GSR) is active. GSR defaults to active-High but can be inverted by adding an inverter in front of the GSR input of the appropriate STARTUP\_architecture symbol.

## Logic Table

Inputs			Outputs					
R	CE	C	Q3	Q2	Q1	Q0	TC	CEO
1	X	↑	0	0	0	0	0	0
0	1	↑	Inc	Inc	Inc	Inc	TC	CEO
0	0	X	No Change	No Change	No Change	No Change	TC	0
0	1	X	1	0	0	1	1	1

$TC = Q3 \cdot !Q2 \cdot !Q1 \cdot Q0$   
 $CEO = TC \cdot CE$

## Design Entry Method

This design element is only for use in schematics.

## For More Information

See the [Spartan-6 FPGA User Documentation \(User Guides and Data Sheets\)](#).

# CD4RLE

## Macro: 4-Bit Loadable Cascadable BCD Counter with Clock Enable and Synchronous Reset

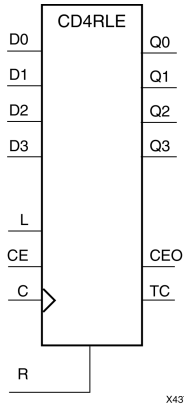

### Introduction

CD4RLE is a 4-bit (stage), synchronous loadable, resettable, binary-coded-decimal (BCD) counter. The synchronous reset input (R) is the highest priority input. When R is High, all other inputs are ignored; the Q outputs, terminal count (TC), and clock enable out (CEO) go to logic level zero on the Low-to-High clock transitions. The data on the D inputs is loaded into the counter when the load enable input (L) is High during the Low-to-High clock (C) transition. The Q outputs increment when the clock enable input (CE) is High during the Low-to-High clock transition. The counter ignores clock transitions when CE is Low. The TC output is High when Q3 and Q0 are High and Q2 and Q1 are Low.

The counter recovers from any of six possible illegal states and returns to a normal count sequence within two clock cycles for Xilinx® devices, as shown in the following state diagram:

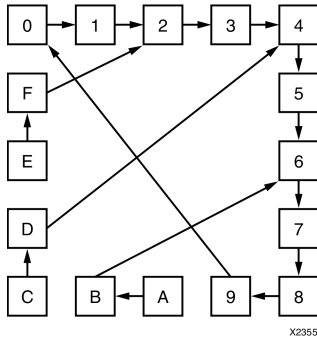

Create larger counters by connecting the CEO output of each stage to the CE input of the next stage and connecting the C, L, and R inputs in parallel. CEO is active (High) when TC and CE are High. The maximum length of the counter is determined by the accumulated CE-to-TC propagation delays versus the clock period. The clock period must be greater than  $n(t_{CE-TC})$ , where  $n$  is the number of stages and the time  $t_{CE-TC}$  is the CE-to-TC propagation delay of each stage. When cascading counters, use the CEO output if the counter uses the CE input or use the TC output if it does not.

This counter is asynchronously cleared, outputs Low, when power is applied. For FPGA devices, power-on conditions are simulated when global set/reset (GSR) is active. GSR defaults to active-High but can be inverted by adding an inverter in front of the GSR input of the appropriate STARTUP\_architecture symbol.

## Logic Table

Inputs					Outputs					
R	L	CE	D3 : D0	C	Q3	Q2	Q1	Q0	TC	CEO
1	X	X	X	↑	0	0	0	0	0	0
0	1	X	D3 : D0	↑	D3	D	D	D0	TC	CEO
0	0	1	X	↑	Inc	Inc	Inc	Inc	TC	CEO
0	0	0	X	X	No Change	No Change	No Change	No Change	TC	0
0	0	1	X	X	1	0	0	1	1	1
$TC = Q3 \cdot !Q2 \cdot !Q1 \cdot Q0$ $CEO = TC \cdot CE$										

## Design Entry Method

This design element is only for use in schematics.

## For More Information

See the [Spartan-6 FPGA User Documentation \(User Guides and Data Sheets\)](#).

## CFGLUT5

### Primitive: 5-input Dynamically Reconfigurable Look-Up Table (LUT)

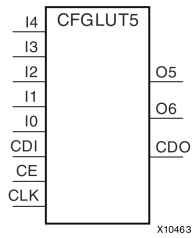

### Introduction

This element is a runtime, dynamically reconfigurable, 5-input look-up table (LUT) that enables the changing of the logical function of the LUT during circuit operation. Using the CDI pin, a new INIT value can be synchronously shifted in serially to change the logical function. The O6 output pin produces the logical output function, based on the current INIT value loaded into the LUT and the currently selected I0-I4 input pins. Optionally, you can use the O5 output in combination with the O6 output to create two individual 4-input functions sharing the same inputs or a 5-input function and a 4-input function that uses a subset of the 5-input logic (see tables below). This component occupies one of the four LUT6 components within a Slice-M.

To cascade this element, connect the CDO pin from each element to the CDI input of the next element. This will allow a single serial chain of data (32-bits per LUT) to reconfigure multiple LUTs.

### Port Descriptions

Port	Direction	Width	Function
O6	Output	1	5-LUT output
O5	Output	1	4-LUT output
I0, I1, I2, I3, I4	Input	1	LUT inputs
CDO	Output	1	Reconfiguration data cascaded output (optionally connect to the CDI input of a subsequent LUT)
CDI	Input	1	Reconfiguration data serial input
CLK	Input	1	Reconfiguration clock
CE	Input	1	Active high reconfiguration clock enable

### Design Entry Method

This design element can be used in schematics.

- Connect the CLK input to the clock source used to supply the reconfiguration data.
- Connect the CDI input to the source of the reconfiguration data.
- Connect the CE pin to the active high logic if you need to enable/disable LUT reconfiguration.
- Connect the I4-I0 pins to the source inputs to the logic equation. The logic function is output on O6 and O5.
- To cascade this element, connect the CDO pin from each element to the CDI input of the next element to allow a single serial chain of data to reconfigure multiple LUTs.

The INIT attribute should be placed on this design element to specify the initial logical function of the LUT. A new INIT can be loaded into the LUT any time during circuit operation by shifting in 32-bits per LUT in the chain, representing the new INIT value. Disregard the O6 and O5 output data until all 32-bits of new INIT data has been clocked into the LUT. The logical function of the LUT changes as new INIT data is shifted into it. Data should be shifted in MSB (INIT[31]) first and LSB (INIT[0]) last.

In order to understand the O6 and O5 logical value based on the current INIT, see the table below:

I4 I3 I2 I1 I0	O6 Value	O5 Value
1 1 1 1 1	INIT[31]	INIT[15]
1 1 1 1 0	INIT[30]	INIT[14]
...	...	...
1 0 0 0 1	INIT[17]	INIT[1]
1 0 0 0 0	INIT[16]	INIT[0]
0 1 1 1 1	INIT[15]	INIT[15]
0 1 1 1 0	INIT[14]	INIT[14]
...	...	...
0 0 0 0 1	INIT[1]	INIT[1]
0 0 0 0 0	INIT[0]	INIT[0]

For instance, the INIT value of FFFF8000 would represent the following logical equations:

- $O6 = I4$  or (I3 and I2 and I1 and I0)
- $O5 = I3$  and I2 and I1 and I0

To use these elements as two, 4-input LUTs with the same inputs but different functions, tie the I4 signal to a logical one. The INIT[31:16] values apply to the logical values of the O6 output and INIT [15:0] apply to the logical values of the O5 output.

## Available Attributes

Attribute	Data Type	Allowed Values	Default	Description
INIT	Hexadecimal	Any 32-bit Value	All zeros	Specifies the initial logical expression of this element.

## For More Information

- See the [Spartan-6 FPGA Configurable Logic Block User Guide \(UG384\)](#).
- See the [Spartan-6 FPGA Data Sheet: DC and Switching Characteristics \(DS162\)](#).



# CJ4CE

## Macro: 4-Bit Johnson Counter with Clock Enable and Asynchronous Clear

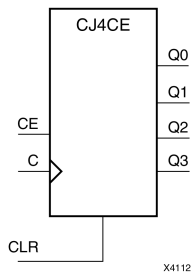

### Introduction

This design element is a clearable Johnson/shift counter. The asynchronous clear (CLR) input, when High, overrides all other inputs and forces the data (Q) outputs to logic level zero, independent of clock (C) transitions. The counter increments (shifts Q0 to Q1, Q1 to Q2, and so forth) when the clock enable input (CE) is High during the Low-to-High clock transition. Clock transitions are ignored when (CE) is Low.

The Q3 output is inverted and fed back to input Q0 to provide continuous counting operation.

This counter is asynchronously cleared, outputs Low, when power is applied. For FPGA devices, power-on conditions are simulated when global set/reset (GSR) is active. GSR defaults to active-High but can be inverted by adding an inverter in front of the GSR input of the appropriate STARTUP\_architecture symbol.

### Logic Table

Inputs			Outputs	
CLR	CE	C	Q0	Q1 through Q3
1	X	X	0	0
0	0	X	No change	No change
0	1	↑	!q3	q0 through q2

q = state of referenced output one setup time prior to active clock transition

### Design Entry Method

This design element is only for use in schematics.

### For More Information

See the [Spartan-6 FPGA User Documentation \(User Guides and Data Sheets\)](#).

## CJ4RE

### Macro: 4-Bit Johnson Counter with Clock Enable and Synchronous Reset

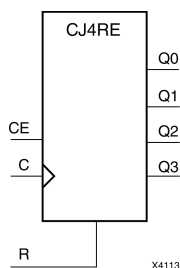

## Introduction

This design element is a resettable Johnson/shift counter. The synchronous reset (R) input, when High, overrides all other inputs and forces the data (Q) outputs to logic level zero during the Low-to-High clock (C) transition. The counter increments (shifts Q0 to Q1, Q1 to Q2, and so forth) when the clock enable input (CE) is High during the Low-to-High clock transition. Clock transitions are ignored when CE is Low.

The Q3 output is inverted and fed back to input Q0 to provide continuous counting operation.

This counter is asynchronously cleared, outputs Low, when power is applied. For FPGA devices, power-on conditions are simulated when global set/reset (GSR) is active. GSR defaults to active-High but can be inverted by adding an inverter in front of the GSR input of the appropriate *STARTUP\_architecture* symbol.

## Logic Table

Inputs			Outputs	
R	CE	C	Q0	Q1 through Q3
1	X	↑	0	0
0	0	X	No change	No change
0	1	↑	!q3	q0 through q2

q = state of referenced output one setup time prior to active clock transition

## Design Entry Method

This design element is only for use in schematics.

## For More Information

See the [Spartan-6 FPGA User Documentation \(User Guides and Data Sheets\)](#).

## CJ5CE

### Macro: 5-Bit Johnson Counter with Clock Enable and Asynchronous Clear

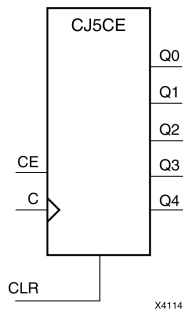

## Introduction

This design element is a clearable Johnson/shift counter. The asynchronous clear (CLR) input, when High, overrides all other inputs and forces the data (Q) outputs to logic level zero, independent of clock (C) transitions. The counter increments (shifts Q0 to Q1, Q1 to Q2, and so forth) when the clock enable input (CE) is High during the Low-to-High clock transition. Clock transitions are ignored when (CE) is Low.

The Q4 output is inverted and fed back to input Q0 to provide continuous counting operation.

This counter is asynchronously cleared, outputs Low, when power is applied. For FPGA devices, power-on conditions are simulated when global set/reset (GSR) is active. GSR defaults to active-High but can be inverted by adding an inverter in front of the GSR input of the appropriate *STARTUP\_architecture* symbol.

## Logic Table

Inputs			Outputs	
CLR	CE	C	Q0	Q1 through Q4
1	X	X	0	0
0	0	X	No change	No change
0	1	↑	!q4	q0 through q3

q = state of referenced output one setup time prior to active clock transition

## Design Entry Method

This design element is only for use in schematics.

## For More Information

See the [Spartan-6 FPGA User Documentation \(User Guides and Data Sheets\)](#).

## CJ5RE

### Macro: 5-Bit Johnson Counter with Clock Enable and Synchronous Reset

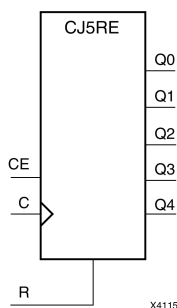

## Introduction

This design element is a resettable Johnson/shift counter. The synchronous reset (R) input, when High, overrides all other inputs and forces the data (Q) outputs to logic level zero during the Low-to-High clock (C) transition. The counter increments (shifts Q0 to Q1, Q1 to Q2, and so forth) when the clock enable input (CE) is High during the Low-to-High clock transition. Clock transitions are ignored when CE is Low.

The Q4 output is inverted and fed back to input Q0 to provide continuous counting operation.

This counter is asynchronously cleared, outputs Low, when power is applied. For FPGA devices, power-on conditions are simulated when global set/reset (GSR) is active. GSR defaults to active-High but can be inverted by adding an inverter in front of the GSR input of the appropriate `STARTUP_architecture` symbol.

## Logic Table

Inputs			Outputs	
R	CE	C	Q0	Q1 through Q4
1	X	↑	0	0
0	0	X	No change	No change
0	1	↑	!q4	q0 through q3

q = state of referenced output one setup time prior to active clock transition

## Design Entry Method

This design element is only for use in schematics.

## For More Information

See the [Spartan-6 FPGA User Documentation \(User Guides and Data Sheets\)](#).

## CJ8CE

### Macro: 8-Bit Johnson Counter with Clock Enable and Asynchronous Clear

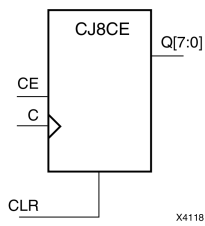

## Introduction

This design element is a clearable Johnson/shift counter. The asynchronous clear (CLR) input, when High, overrides all other inputs and forces the data (Q) outputs to logic level zero, independent of clock (C) transitions. The counter increments (shifts Q0 to Q1, Q1 to Q2, and so forth) when the clock enable input (CE) is High during the Low-to-High clock transition. Clock transitions are ignored when (CE) is Low.

The Q7 output is inverted and fed back to input Q0 to provide continuous counting operation.

This counter is asynchronously cleared, outputs Low, when power is applied. For FPGA devices, power-on conditions are simulated when global set/reset (GSR) is active. GSR defaults to active-High but can be inverted by adding an inverter in front of the GSR input of the appropriate `STARTUP_architecture` symbol.

## Logic Table

Inputs			Outputs	
CLR	CE	C	Q0	Q1 through Q8
1	X	X	0	0
0	0	X	No change	No change
0	1	↑	!q7	q0 through q7

q = state of referenced output one setup time prior to active clock transition

## Design Entry Method

This design element is only for use in schematics.

## For More Information

See the [Spartan-6 FPGA User Documentation \(User Guides and Data Sheets\)](#).

## CJ8RE

### Macro: 8-Bit Johnson Counter with Clock Enable and Synchronous Reset

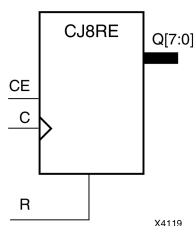

## Introduction

This design element is a resettable Johnson/shift counter. The synchronous reset (R) input, when High, overrides all other inputs and forces the data (Q) outputs to logic level zero during the Low-to-High clock (C) transition. The counter increments (shifts Q0 to Q1, Q1 to Q2, and so forth) when the clock enable input (CE) is High during the Low-to-High clock transition. Clock transitions are ignored when CE is Low.

The Q7 output is inverted and fed back to input Q0 to provide continuous counting operation.

This counter is asynchronously cleared, outputs Low, when power is applied. For FPGA devices, power-on conditions are simulated when global set/reset (GSR) is active. GSR defaults to active-High but can be inverted by adding an inverter in front of the GSR input of the appropriate `STARTUP_architecture` symbol.

## Logic Table

Inputs			Outputs	
R	CE	C	Q0	Q1 through Q7
1	X	↑	0	0
0	0	X	No change	No change
0	1	↑	!q7	q0 through q6

q = state of referenced output one setup time prior to active clock transition

## Design Entry Method

This design element is only for use in schematics.

## For More Information

See the [Spartan-6 FPGA User Documentation \(User Guides and Data Sheets\)](#).

## COMP16

### Macro: 16-Bit Identity Comparator

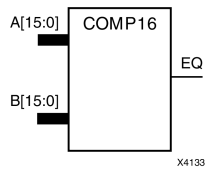

### Introduction

This design element is a 16-bit identity comparator. The equal output (EQ) is high when A15 : A0 and B15 : B0 are equal.

Equality is determined by a bit comparison of the two words. When any two of the corresponding bits from each word are not the same, the EQ output is Low.

### Design Entry Method

This design element is only for use in schematics.

### For More Information

See the [Spartan-6 FPGA User Documentation \(User Guides and Data Sheets\)](#).

## COMP2

### Macro: 2-Bit Identity Comparator

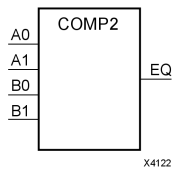

## Introduction

This design element is a 2-bit identity comparator. The equal output (EQ) is High when the two words A1 : A0 and B1 : B0 are equal.

Equality is determined by a bit comparison of the two words. When any two of the corresponding bits from each word are not the same, the EQ output is Low.

## Design Entry Method

This design element is only for use in schematics.

## For More Information

See the [Spartan-6 FPGA User Documentation \(User Guides and Data Sheets\)](#).



## COMP4

### Macro: 4-Bit Identity Comparator

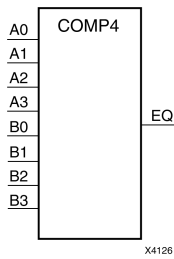

## Introduction

This design element is a 4-bit identity comparator. The equal output (EQ) is high when A3 : A0 and B3 : B0 are equal.

Equality is determined by a bit comparison of the two words. When any two of the corresponding bits from each word are not the same, the EQ output is Low.

## Design Entry Method

This design element is only for use in schematics.

## For More Information

See the [Spartan-6 FPGA User Documentation \(User Guides and Data Sheets\)](#).

## COMP8

### Macro: 8-Bit Identity Comparator

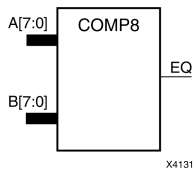

## Introduction

This design element is an 8-bit identity comparator. The equal output (EQ) is high when A7 : A0 and B7 : B0 are equal.

Equality is determined by a bit comparison of the two words. When any two of the corresponding bits from each word are not the same, the EQ output is Low.

## Design Entry Method

This design element is only for use in schematics.

## For More Information

See the [Spartan-6 FPGA User Documentation \(User Guides and Data Sheets\)](#).

# COMP16

## Macro: 16-Bit Magnitude Comparator

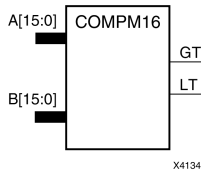

### Introduction

This design element is a 16-bit magnitude comparator that compare two positive Binary-weighted words. It compares A15 : A0 and B15 : B0, where A15 and B15 are the most significant bits.

The greater-than output (GT) is High when A > B, and the less-than output (LT) is High when A < B. When the two words are equal, both GT and LT are Low. Equality can be measured with this macro by comparing both outputs with a NOR gate.

### Logic Table

Inputs								Outputs	
A7, B7	A6, B6	A5, B5	A4, B4	A3, B3	A2, B2	A1, B1	A0, B0	GT	LT
A7>B7	X	X	X	X	X	X	X	1	0
A7<B7	X	X	X	X	X	X	X	0	1
A7=B7	A6>B6	X	X	X	X	X	X	1	0
A7=B7	A6<B6	X	X	X	X	X	X	0	1
A7=B7	A6=B6	A5>B5	X	X	X	X	X	1	0
A7=B7	A6=B6	A5<B5	X	X	X	X	X	0	1
A7=B7	A6=B6	A5=B5	A4>B4	X	X	X	X	1	0
A7=B7	A6=B6	A5=B5	A4<B4	X	X	X	X	0	1
A7=B7	A6=B6	A5=B5	A4=B4	A3>B3	X	X	X	1	0
A7=B7	A6=B6	A5=B5	A4=B4	A3<B3	X	X	X	0	1
A7=B7	A6=B6	A5=B5	A4=B4	A3=B3	A2>B2	X	X	1	0
A7=B7	A6=B6	A5=B5	A4=B4	A3=B3	A2<B2	X	X	0	1
A7=B7	A6=B6	A5=B5	A4=B4	A3=B3	A2=B2	A1>B1	X	1	0
A7=B7	A6=B6	A5=B5	A4=B4	A3=B3	A2=B2	A1<B1	X	0	1
A7=B7	A6=B6	A5=B5	A4=B4	A3=B3	A2=B2	A1=B1	A0>B0	1	0
A7=B7	A6=B6	A5=B5	A4=B4	A3=B3	A2=B2	A1=B1	A0<B0	0	1
A7=B7	A6=B6	A5=B5	A4=B4	A3=B3	A2=B2	A1=B1	A0=B0	0	0

### Design Entry Method

This design element is only for use in schematics.

### For More Information

See the [Spartan-6 FPGA User Documentation \(User Guides and Data Sheets\)](#).

## COMPM2

### Macro: 2-Bit Magnitude Comparator

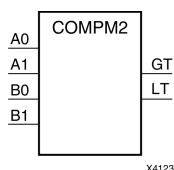

## Introduction

This design element is a 2-bit magnitude comparator that compare two positive binary-weighted words. It compares A1 : A0 and B1 : B0, where A1 and B1 are the most significant bits.

The greater-than output (GT) is High when  $A > B$ , and the less-than output (LT) is High when  $A < B$ . When the two words are equal, both GT and LT are Low. Equality can be measured with this macro by comparing both outputs with a NOR gate.

## Logic Table

Inputs				Outputs	
A1	B1	A0	B0	GT	LT
0	0	0	0	0	0
0	0	1	0	1	0
0	0	0	1	0	1
0	0	1	1	0	0
1	1	0	0	0	0
1	1	1	0	1	0
1	1	0	1	0	1
1	1	1	1	0	0
1	0	X	X	1	0
0	1	X	X	0	1

## Design Entry Method

This design element is only for use in schematics.

## For More Information

See the [Spartan-6 FPGA User Documentation \(User Guides and Data Sheets\)](#).

# COMPM4

## Macro: 4-Bit Magnitude Comparator

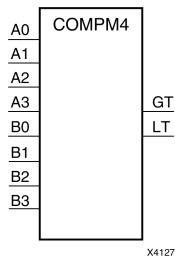

### Introduction

This design element is a 4-bit magnitude comparator that compare two positive Binary-weighted words. It compares A3 : A0 and B3 : B0, where A3 and B3 are the most significant bits.

The greater-than output (GT) is High when  $A > B$ , and the less-than output (LT) is High when  $A < B$ . When the two words are equal, both GT and LT are Low. Equality can be measured with this macro by comparing both outputs with a NOR gate.

### Logic Table

Inputs				Outputs	
A3, B3	A2, B2	A1, B1	A0, B0	GT	LT
A3>B3	X	X	X	1	0
A3<B3	X	X	X	0	1
A3=B3	A2>B2	X	X	1	0
A3=B3	A2<B2	X	X	0	1
A3=B3	A2=B2	A1>B1	X	1	0
A3=B3	A2=B2	A1<B1	X	0	1
A3=B3	A2=A2	A1=B1	A0>B0	1	0
A3=B3	A2=B2	A1=B1	A0<B0	0	1
A3=B3	A2=B2	A1=B1	A0=B0	0	0

### Design Entry Method

This design element is only for use in schematics.

### For More Information

See the [Spartan-6 FPGA User Documentation \(User Guides and Data Sheets\)](#).

## COMPM8

### Macro: 8-Bit Magnitude Comparator

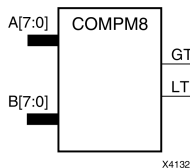

### Introduction

This design element is an 8-bit magnitude comparator that compare two positive Binary-weighted words. It compares A7 : A0 and B7 : B0, where A7 and B7 are the most significant bits.

The greater-than output (GT) is High when  $A > B$ , and the less-than output (LT) is High when  $A < B$ . When the two words are equal, both GT and LT are Low. Equality can be measured with this macro by comparing both outputs with a NOR gate.

### Logic Table

Inputs								Outputs	
A7, B7	A6, B6	A5, B5	A4, B4	A3, B3	A2, B2	A1, B1	A0, B0	GT	LT
A7>B7	X	X	X	X	X	X	X	1	0
A7<B7	X	X	X	X	X	X	X	0	1
A7=B7	A6>B6	X	X	X	X	X	X	1	0
A7=B7	A6<B6	X	X	X	X	X	X	0	1
A7=B7	A6=B6	A5>B5	X	X	X	X	X	1	0
A7=B7	A6=B6	A5<B5	X	X	X	X	X	0	1
A7=B7	A6=B6	A5=B5	A4>B4	X	X	X	X	1	0
A7=B7	A6=B6	A5=B5	A4<B4	X	X	X	X	0	1
A7=B7	A6=B6	A5=B5	A4=B4	A3>B3	X	X	X	1	0
A7=B7	A6=B6	A5=B5	A4=B4	A3<B3	X	X	X	0	1
A7=B7	A6=B6	A5=B5	A4=B4	A3=B3	A2>B2	X	X	1	0
A7=B7	A6=B6	A5=B5	A4=B4	A3=B3	A2<B2	X	X	0	1
A7=B7	A6=B6	A5=B5	A4=B4	A3=B3	A2=B2	A1>B1	X	1	0
A7=B7	A6=B6	A5=B5	A4=B4	A3=B3	A2=B2	A1<B1	X	0	1
A7=B7	A6=B6	A5=B5	A4=B4	A3=B3	A2=B2	A1=B1	A0>B0	1	0
A7=B7	A6=B6	A5=B5	A4=B4	A3=B3	A2=B2	A1=B1	A0<B0	0	1
A7=B7	A6=B6	A5=B5	A4=B4	A3=B3	A2=B2	A1=B1	A0=B0	0	0

### Design Entry Method

This design element is only for use in schematics.

### For More Information

See the [Spartan-6 FPGA User Documentation \(User Guides and Data Sheets\)](#).

# COMP16

## Macro: 16-Bit Magnitude Comparator

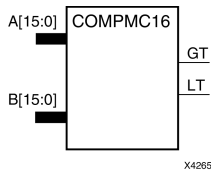

### Introduction

This design element is a 16-bit, magnitude comparator that compares two positive Binary weighted words A15 : A0 and B15 : B0, where A15 and B15 are the most significant bits.

This comparator is implemented using carry logic with relative location constraints to ensure efficient logic placement.

The greater-than output (GT) is High when  $A > B$ , and the less-than output (LT) is High when  $A < B$ . When the two words are equal, both GT and LT are Low. Equality can be flagged with this macro by connecting both outputs to a NOR gate.

### Logic Table

Inputs								Outputs	
A7, B7	A6, B6	A5, B5	A4, B4	A3, B3	A2, B2	A1, B1	A0, B0	GT	LT
A7>B7	X	X	X	X	X	X	X	1	0
A7<B7	X	X	X	X	X	X	X	0	1
A7=B7	A6>B6	X	X	X	X	X	X	1	0
A7=B7	A6<B6	X	X	X	X	X	X	0	1
A7=B7	A6=B6	A5>B5	X	X	X	X	X	1	0
A7=B7	A6=B6	A5<B5	X	X	X	X	X	0	1
A7=B7	A6=B6	A5=B5	A4>B4	X	X	X	X	1	0
A7=B7	A6=B6	A5=B5	A4<B4	X	X	X	X	0	1
A7=B7	A6=B6	A5=B5	A4=B4	A3>B3	X	X	X	1	0
A7=B7	A6=B6	A5=B5	A4=B4	A3<B3	X	X	X	0	1
A7=B7	A6=B6	A5=B5	A4=B4	A3=B3	A2>B2	X	X	1	0
A7=B7	A6=B6	A5=B5	A4=B4	A3=B3	A2<B2	X	X	0	1
A7=B7	A6=B6	A5=B5	A4=B4	A3=B3	A2=B2	A1>B1	X	1	0
A7=B7	A6=B6	A5=B5	A4=B4	A3=B3	A2=B2	A1<B1	X	0	1
A7=B7	A6=B6	A5=B5	A4=B4	A3=B3	A2=B2	A1=B1	A0>B0	1	0
A7=B7	A6=B6	A5=B5	A4=B4	A3=B3	A2=B2	A1=B1	A0<B0	0	1
A7=B7	A6=B6	A5=B5	A4=B4	A3=B3	A2=B2	A1=B1	A0=B0	0	0

### Design Entry Method

This design element is only for use in schematics.

## For More Information

See the [Spartan-6 FPGA User Documentation \(User Guides and Data Sheets\)](#).



# COMP8

## Macro: 8-Bit Magnitude Comparator

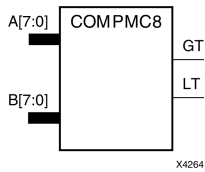

### Introduction

This design element is an 8-bit, magnitude comparator that compares two positive Binaryweighted words A7 : A0 and B7 : B0, where A7 and B7 are the most significant bits.

This comparator is implemented using carry logic with relative location constraints to ensure efficient logic placement.

The greater-than output (GT) is High when A>B, and the less-than output (LT) is High when A<B. When the two words are equal, both GT and LT are Low. Equality can be flagged with this macro by connecting both outputs to a NOR gate.

### Logic Table

Inputs								Outputs	
A7, B7	A6, B6	A5, B5	A4, B4	A3, B3	A2, B2	A1, B1	A0, B0	GT	LT
A7>B7	X	X	X	X	X	X	X	1	0
A7<B7	X	X	X	X	X	X	X	0	1
A7=B7	A6>B6	X	X	X	X	X	X	1	0
A7=B7	A6<B6	X	X	X	X	X	X	0	1
A7=B7	A6=B6	A5>B5	X	X	X	X	X	1	0
A7=B7	A6=B6	A5<B5	X	X	X	X	X	0	1
A7=B7	A6=B6	A5=B5	A4>B4	X	X	X	X	1	0
A7=B7	A6=B6	A5=B5	A4<B4	X	X	X	X	0	1
A7=B7	A6=B6	A5=B5	A4=B4	A3>B3	X	X	X	1	0
A7=B7	A6=B6	A5=B5	A4=B4	A3<B3	X	X	X	0	1
A7=B7	A6=B6	A5=B5	A4=B4	A3=B3	A2>B2	X	X	1	0
A7=B7	A6=B6	A5=B5	A4=B4	A3=B3	A2<B2	X	X	0	1
A7=B7	A6=B6	A5=B5	A4=B4	A3=B3	A2=B2	A1>B1	X	1	0
A7=B7	A6=B6	A5=B5	A4=B4	A3=B3	A2=B2	A1<B1	X	0	1
A7=B7	A6=B6	A5=B5	A4=B4	A3=B3	A2=B2	A1=B1	A0>B0	1	0
A7=B7	A6=B6	A5=B5	A4=B4	A3=B3	A2=B2	A1=B1	A0<B0	0	1
A7=B7	A6=B6	A5=B5	A4=B4	A3=B3	A2=B2	A1=B1	A0=B0	0	0

### Design Entry Method

This design element is only for use in schematics.

## For More Information

See the [Spartan-6 FPGA User Documentation \(User Guides and Data Sheets\)](#).

## CR16CE

Macro: 16-Bit Negative-Edge Binary Ripple Counter with Clock Enable and Asynchronous Clear

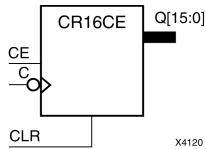

### Introduction

This design element is a 16-bit cascadable, clearable, binary ripple counter with clock enable and asynchronous clear.

Larger counters can be created by connecting the last Q output of the first stage to the clock input of the next stage. CLR and CE inputs are connected in parallel. The clock period is not affected by the overall length of a ripple counter. The overall clock-to-output propagation is  $n(t_{c-Q})$ , where n is the number of stages and the time  $t_{c-Q}$  is the C-to-Qz propagation delay of each stage.

This counter is asynchronously cleared, outputs Low, when power is applied. For FPGA devices, power-on conditions are simulated when global set/reset (GSR) is active. GSR defaults to active-High but can be inverted by adding an inverter in front of the GSR input of the appropriate *STARTUP\_architecture* symbol.

### Logic Table

Inputs			Outputs
CLR	CE	C	Qz : Q0
1	X	X	0
0	0	X	No Change
0	1	↓	Inc

z = bit width - 1

### Design Entry Method

This design element is only for use in schematics.

### For More Information

See the [Spartan-6 FPGA User Documentation \(User Guides and Data Sheets\)](#).

## CR8CE

### Macro: 8-Bit Negative-Edge Binary Ripple Counter with Clock Enable and Asynchronous Clear

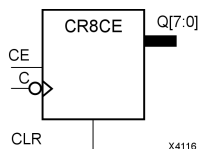

## Introduction

This design element is an 8-bit cascadable, clearable, binary, ripple counter with clock enable and asynchronous clear.

The asynchronous clear (CLR), when High, overrides all other inputs and causes the Q outputs to go to logic level zero. The counter increments when the clock enable input (CE) is High during the High-to-Low clock (C) transition. The counter ignores clock transitions when CE is Low.

Larger counters can be created by connecting the last Q output of the first stage to the clock input of the next stage. CLR and CE inputs are connected in parallel. The clock period is not affected by the overall length of a ripple counter. The overall clock-to-output propagation is  $n(t_{C-Q})$ , where  $n$  is the number of stages and the time  $t_{C-Q}$  is the C-to-Qz propagation delay of each stage.

This counter is asynchronously cleared, outputs Low, when power is applied. For FPGA devices, power-on conditions are simulated when global set/reset (GSR) is active. GSR defaults to active-High but can be inverted by adding an inverter in front of the GSR input of the appropriate `STARTUP_architecture` symbol.

## Logic Table

Inputs			Outputs
CLR	CE	C	Qz : Q0
1	X	X	0
0	0	X	No Change
0	1	↓	Inc
z = bit width - 1			

## Design Entry Method

This design element is only for use in schematics.

## For More Information

See the [Spartan-6 FPGA User Documentation \(User Guides and Data Sheets\)](#).

## D2\_4E

### Macro: 2- to 4-Line Decoder/Demultiplexer with Enable

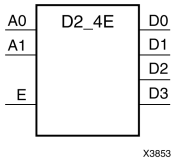

## Introduction

This design element is a decoder/demultiplexer. When the enable (E) input of this element is High, one of four active-High outputs (D3 : D0) is selected with a 2-bit binary address (A1 : A0) input. The non-selected outputs are Low. Also, when the E input is Low, all outputs are Low. In demultiplexer applications, the E input is the data input.

## Logic Table

Inputs			Outputs			
A1	A0	E	D3	D2	D1	D0
X	X	0	0	0	0	0
0	0	1	0	0	0	1
0	1	1	0	0	1	0
1	0	1	0	1	0	0
1	1	1	1	0	0	0

## Design Entry Method

This design element is only for use in schematics.

## For More Information

See the [Spartan-6 FPGA User Documentation \(User Guides and Data Sheets\)](#).

## D3\_8E

### Macro: 3- to 8-Line Decoder/Demultiplexer with Enable

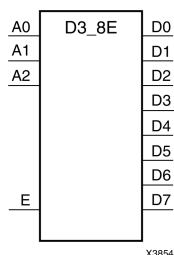

## Introduction

When the enable (E) input of the D3\_8E decoder/demultiplexer is High, one of eight active-High outputs (D7 : D0) is selected with a 3-bit binary address (A2 : A0) input. The non-selected outputs are Low. Also, when the E input is Low, all outputs are Low. In demultiplexer applications, the E input is the data input.

## Logic Table

Inputs				Outputs							
A2	A1	A0	E	D7	D6	D5	D4	D3	D2	D1	D0
X	X	X	0	0	0	0	0	0	0	0	0
0	0	0	1	0	0	0	0	0	0	0	1
0	0	1	1	0	0	0	0	0	0	1	0
0	1	0	1	0	0	0	0	0	1	0	0
0	1	1	1	0	0	0	0	1	0	0	0
1	0	0	1	0	0	0	1	0	0	0	0
1	0	1	1	0	0	1	0	0	0	0	0
1	1	0	1	0	1	0	0	0	0	0	0
1	1	1	1	1	0	0	0	0	0	0	0

## Design Entry Method

This design element is only for use in schematics.

## For More Information

See the [Spartan-6 FPGA User Documentation \(User Guides and Data Sheets\)](#).

## D4\_16E

### Macro: 4- to 16-Line Decoder/Demultiplexer with Enable

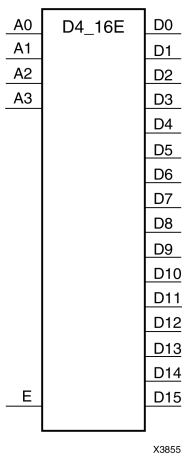

### Introduction

This design element is a decoder/demultiplexer. When the enable (E) input of this design element is High, one of 16 active-High outputs (D15 : D0) is selected with a 4-bit binary address (A3 : A0) input. The non-selected outputs are Low. Also, when the E input is Low, all outputs are Low. In demultiplexer applications, the E input is the data input.

### Design Entry Method

This design element is only for use in schematics.

### For More Information

See the [Spartan-6 FPGA User Documentation \(User Guides and Data Sheets\)](#).

## DCM\_CLKGEN

Primitive: Digital Clock Manager.

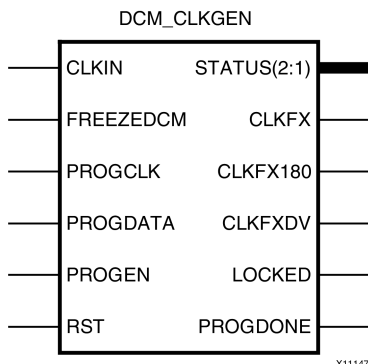

### Introduction

Digital Clock Manager (DCM) is set to frequency aligned mode and thus is not phase aligned (no phase relationship) to the input clock. By being in frequency aligned mode, it allows additional capabilities including programmable output clock synthesis, jitter reduction, spread spectrum, and free running oscillator modes. Please refer to the *Spartan-6 FPGA Clocking Resources User Guide (UG382)* for details in using this component.

### Port Descriptions

Port	Direction	Width	Function
CLKFX	Output	1	Synthesized clock output, controlled by the CLKFX_MULTIPLY and CLKFX_DIVIDE attributes. Can be either statically set or dynamically programmed through a dedicated 4-wire SPI port (PROGDATA, PROGCLK, PROGDONE, and PROGEN). Always has a 50% duty cycle.
CLKFXDV	Output	1	Divided CLKFX output clock. Divide value derived from CLKFXDV_DIVIDE attribute. There is no phase alignment between CLKFX and CLKFXDV.
CLKFX180	Output	1	Synthesized clock output CLKFX, 180 phase shift (appears to be an inverted version of CLKFX). Always has a 50% duty cycle.
CLKIN	Input	1	Clock input to DCM. Always required. The CLKIN frequency and jitter must fall within the limits specified in the data sheet. In the case of free-running oscillator mode, running clock needs to be connected until DCM is locked and DCM is frozen, then clock can be removed. In the other modes, a free running clock needs to be provided and remains.
FREEZEDCM	Input	1	Prevents tap adjustment drift in the event of a lost CLKIN input. The DCM is then configured into a free-run mode.
LOCKED	Output	1	Synchronous output indicates whether the DCM is ready for operation. <ul style="list-style-type: none"> <li>0 - DCM clock outputs are not valid</li> <li>1 - DCM is ready for operation</li> <li>1-to-0 - DCM lost LOCK. Reset DCM</li> </ul>
PROGCLK	Input	1	Clock input for M and/or D reconfiguration.
PROGDATA	Input	1	Serial data input to supply information for the reprogramming of M and D values of the DCM. This input must be applied synchronous to the PROGCLK input.



Port	Direction	Width	Function
PROGDONE	Output	1	Active high output to indicate the successful reprogramming of an M or D value.
PROGEN	Input	1	Active high enable input for the reprogramming of M/D values. This input must be applied synchronously to the PROGCLK input.
RST	Input	1	Resets the DCM circuitry. The RST signal is an active High asynchronous reset. Asserting the RST signal asynchronously forces all DCM outputs Low (the LOCKED signal, all status signals, and all output clocks within four source clock cycles). Because the reset is asynchronous, the last cycle of the clocks can exhibit an unintended short pulse, severely distorted duty-cycle, and no longer phase adjust with respect to one another while deasserting. The RST pin must be used when reconfiguring the device or changing the input frequency. Deasserting the RST signal synchronously starts the locking process at the next CLKIN cycle. To ensure a proper DCM reset and locking process, the RST signal must be deasserted after the CLKIN signal has been present and stable for at least three clock cycles. In all designs, the DCM must be held in reset until the clock is stable. During configuration, the DCM is automatically held in reset until GSR is released. If the clock is stable when GSR is released, DCM reset after configuration is not necessary.
STATUS[2:1]	Output	2	Clock Status lines. <ul style="list-style-type: none"> <li>STATUS[1] indicates that CLKIN has stopped.</li> <li>STATUS[2] indicates that CLKFX or CLKFX180 has stopped.</li> </ul>

## Design Entry Method

This design element can be used in schematics.

## Available Attributes

Attribute	Data Type	Allowed Values	Default	Description
CLKFX_DIVIDE	Integer	1 to 256	1	This value in conjunction with the input frequency and CLKFX_MULTIPLY value, determines the resultant output frequency for the CLKFX and CLKFX180 outputs.
CLKFXDV_DIVIDE	Integer	2, 4, 8, 16, 32	2	Specifies divide value for CLKFXDV.
CLKFX_MD_MAX	3 significant digit Float	0.000 to 256.000	0.000	When using the DCM_CLKGEN with variable M and D values, this would specify the maximum ratio of M and D used during static timing analysis.
CLKFX_MULTIPLY	Integer	2 to 256	4	This value in conjunction with the input frequency and CLKFX_DIVIDE value, determine the resultant output frequency for the CLKFX and CLKFX180 outputs.
CLKIN_PERIOD	Float	2.000 to 1000.00	None	This attribute specifies the source clock period which is used to help the DCM adjust for the optimum

Attribute	Data Type	Allowed Values	Default	Description
				CLKFX/CLKFX180 outputs and also result in faster locking time.
DFS_BANDWIDTH	String	"OPTIMIZED", "HIGH", "LOW"	"OPTIMIZED"	Specifies the frequency adjust bandwidth of the DCM due to process, voltage, and temperature (PVT).
PROG_MD_BANDWIDTH	String	"OPTIMIZED", "HIGH", "LOW"	"OPTIMIZED"	Specifies the frequency adjust bandwidth of the DCM due to change of programming of the M and D values.
SPREAD_SPECTRUM	String	"NONE", "CENTER_LOW_SPREAD", "CENTER_HIGH_SPREAD", "VIDEO_LINK_M0", "VIDEO_LINK_M1", "VIDEO_LINK_M2"	"NONE"	Specifies a supported mode for Spread Spectrum. Must be used in conjunction with the appropriate IP to fully realize the frequency hopping.  Used for fixed spread spectrum ("CENTER_LOW_SPREAD" and "CENTER_HIGH_SPREAD") or soft spread spectrum ("VIDEO_LINK_M0", "VIDEO_LINK_M1", and "VIDEO_LINK_M2"). Soft spread spectrum must be used in conjunction with the soft spread spectrum reference design.
STARTUP_WAIT	Boolean	FALSE, TRUE	FALSE	Delays the configuration DONE signal until DCM LOCKED signal goes high.

## For More Information

- See the [Spartan-6 FPGA Clocking Resources User Guide \(UG382\)](#).
- See the [Spartan-6 FPGA Data Sheet: DC and Switching Characteristics \(DS162\)](#).

# DCM\_SP

## Primitive: Digital Clock Manager

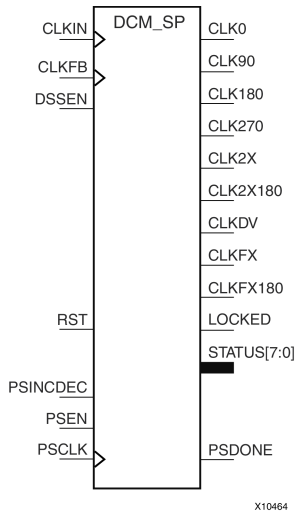

## Introduction

This design element is a digital clock manager that provides multiple functions. It can implement a clock delay locked loop (DLL), a digital frequency synthesizer (DFS), and a digital phase shifter (DPS). DCM\_SPs are useful for eliminating the clock delay coming on and off the chip, shifting the clock phase to improve data capture, deriving different frequency clocks, as well as other useful clocking functions.

## Port Descriptions

Port	Direction	Width	Function
CLKDV	Output	1	Divided clock output, controlled by the CLKDV_DIVIDE attribute. The CLKDV output has a 50% duty cycle unless the CLKDV_DIVIDE attribute is a non-integer value.
CLKFB	Input	1	Clock feedback input to DCM. The feedback input is required unless the DFS outputs, CLKFX or CLKFX180, are used standalone. The source of the CLKFB input must be the CLK0 or CLK2X output from the DCM and the CLK_FEEDBACK must be set to 1X or 2X accordingly. When set to NONE, CLKFB is unused and should be tied low. Ideally, the feedback point includes the delay added by the clock distribution network, either internally or externally.
CLKFX	Output	1	Synthesized clock output, controlled by the CLKFX_MULTIPLY and CLKFX_DIVIDE attributes. Always has a 50% duty cycle. If no phase relationship is necessary, then no clock feedback is required.
CLKFX180	Output	1	Synthesized clock output CLKFX, 180 degree phase shift (an inverted version of CLKFX). Always has a 50% duty cycle. If no phase relationship is necessary, then no feedback loop is required.
CLKIN	Input	1	Clock input to DCM. Always required. The CLKIN frequency and jitter must fall within the limits specified in the data sheet.
CLK0	Output	1	Same frequency as CLKIN, 0 phase shift (i.e., not phase shifted). Always conditioned to a 50% duty cycle on Spartan®-6 FPGAs. CLK_FEEDBACK must be set to 1X or 2X to deskew CLK0.
CLK2X	Output	1	Double-frequency clock output, 0 degree phase shift. When available, the CLK2X output always has a 50% duty cycle. Either CLK0 or CLK2X is required as a feedback source for DLL functions.

Port	Direction	Width	Function
CLK2X180	Output	1	Double-frequency clock output, 180 degree phase shift. When available, the CLK2X180 output always has a 50% duty cycle.
CLK90	Output	1	Same frequency as CLKIN, 90 degree phase shift (quarter period). Always conditioned to a 50% duty cycle on Spartan®-6 FPGAs.
CLK180	Output	1	Same frequency as CLKIN, 180 degree phase shift (half period). Always conditioned to a 50% duty cycle on Spartan®-6 FPGAs.
CLK270	Output	1	Same frequency as CLKIN, 270 degree phase shift (three-quarters period). Always conditioned to a 50% duty cycle on Spartan®-6 FPGAs.
LOCKED	Output	1	All DCM features have locked onto the CLKIN frequency. Clock outputs are now valid, assuming CLKIN is within specified limits. <ul style="list-style-type: none"> <li>0 - DCM is attempting to lock onto CLKIN frequency. DCM clock outputs are not valid.</li> <li>1 - DCM is locked onto CLKIN frequency. DCM clock outputs are valid.</li> <li>1-to-0 - DCM lost lock. Reset DCM.</li> </ul>
PSCLK	Input	1	Clock input to variable phase shifter, clocked on rising edge. When using a global clock buffer, only the upper eight BUFGMUXs can drive PSCLK: BUFGMUX_X2Y1, BUFGMUX_X2Y2, BUFGMUX_X2Y3, BUFGMUX_X2Y4, BUFGMUX_X3Y5, BUFGMUX_X3Y6, BUFGMUX_X3Y7 and BUFGMUX_X3Y8.
PSDONE	Output	1	Variable phase shift operation complete. <ul style="list-style-type: none"> <li>0 - No phase shift operation is active or phase shift operation is in progress.</li> <li>1 - Requested phase shift operation is complete. Output High for one PSCLK cycle. Next variable phase shift operation can commence.</li> </ul>
PSEN	Input	1	Variable phase-shift enable. Can be inverted within a DCM block. Non-inverted behavior shown below. <ul style="list-style-type: none"> <li>0 - Disable variable phase shift. Ignore inputs to phase shifter.</li> <li>1 - Enable variable phase shift operations on next rising PSCLK clock edge.</li> </ul> <p><b>Note</b> Tie to 0 when not in use.</p>
PSINCDEC	Input	1	Increment/decrement variable phase shift. Can be inverted within a DCM block. Non-inverted behavior shown below. <ul style="list-style-type: none"> <li>0 - Decrement phase shift value on next enabled, rising PSCLK clock edge.</li> <li>1 - Increment phase shift value on next enabled, rising PSCLK clock edge.</li> </ul>

Port	Direction	Width	Function
RST	Input	1	<p>Asynchronous reset input. Resets the DCM logic to its postconfiguration state. Causes DCM to reacquire and relock to the CLKIN input. Invertible within DCM block. Non-inverted behavior shown below.</p> <ul style="list-style-type: none"> <li>• 0 - No effect.</li> <li>• 1 - Reset DCM block. Hold RST pulse High for at least three valid CLKIN cycles.</li> </ul>
STATUS[7:0]	Output	8	<p>The status output bus provides DCM status.</p> <ul style="list-style-type: none"> <li>• STATUS[0] - Variable phase shift overflow. Control output for variable fine phase shifting. The variable phase shifter has reached a minimum or maximum limit value. The limit value is either +/-255 or a lesser value if the phase shift has reached the end of the delay line. <ul style="list-style-type: none"> <li>– 0 - The phase shift has not yet reached its limit value.</li> <li>– 1 - The phase shift has reached its limited value.</li> </ul> </li> <li>• STATUS[1] - CLKIN Input Stopped Indicator. Available only when the CLKFB feedback input is connected. Held in reset until the LOCKED output is asserted. Requires at least one CLKIN cycle to become active. Never asserted if CLKIN never toggles. <ul style="list-style-type: none"> <li>– 0 - CLKIN input is toggling.</li> <li>– 1 - CLKIN input is not toggling even though the locked output can still be High.</li> </ul> </li> <li>• STATUS[2] - CLKFX or CLKFX180 output stopped indicator. <ul style="list-style-type: none"> <li>– 0 - CLKFX and CLKFX180 outputs are toggling.</li> <li>– 1 - CLKFX and CLKFX180 outputs are not toggling, even though the LOCKED output can still be High.</li> </ul> </li> <li>• STATUS[4:3] - Reserved.</li> <li>• STATUS[5] - A mirrored version of CLKFX during DCM_SP lock period status.</li> <li>• STATUS[6] - Reserved.</li> <li>• STATUS[7] - A mirrored version of CLKIN during DCM_SP lock period status.</li> </ul>

## Design Entry Method

This design element can be used in schematics.

## Available Attributes

Attribute	Data Type	Allowed Values	Default	Description
CLK_FEEDBACK	String	"1X", "2X", "NONE"	"1X"	<p>Defines the DCM feedback mode.</p> <ul style="list-style-type: none"> <li>• "1X" - CLK0 as feedback.</li> <li>• "2X" - CLK2X as feedback.</li> </ul>
CLKDV_DIVIDE	1 significant digit Float	2.0, 1.5, 2.5, 3.0, 3.5, 4.0, 4.5, 5.0, 5.5, 6.0, 6.5, 7.0, 7.5, 8.0, 9.0, 10.0, 11.0, 12.0, 13.0, 14.0, 15.0, 16.0	2.0	<p>Specifies the extent to which the CLKDLL, CLKDLLE, CLKDLLHF, or DCM_SP clock divider (CLKDV output) is to be frequency divided.</p>

Attribute	Data Type	Allowed Values	Default	Description
CLKFX_DIVIDE	Integer	1 to 32	1	Specifies the frequency divider value for the CLKFX output.
CLKFX_MULTIPLY	Integer	2 to 32	4	Specifies the frequency multiplier value for the CLKFX output.
CLKIN_DIVIDE_BY_2	Boolean	FALSE, TRUE	FALSE	Enables CLKIN divide by two features.
CLKIN_PERIOD	Float	2.000 to 1000.000	None	Specifies the input period to the DCM_SP CLKIN input in ns.
CLKOUT_PHASE_SHIFT	String	"NONE", "FIXED", "VARIABLE"	"NONE"	This attribute specifies the phase shift mode. <ul style="list-style-type: none"> <li>"NONE" - No phase shift capability. Any set value has no effect.</li> <li>"FIXED" - DCM outputs are a fixed phase shift from CLKIN. Value is specified by PHASE_SHIFT attribute.</li> <li>"VARIABLE" - Allows the DCM outputs to be shifted in a positive and negative range relative to CLKIN. Starting value is specified by PHASE_SHIFT.</li> </ul>
DESKEW_ADJUST	String	"SYSTEM_SYNCHRONOUS", "SOURCE_SYNCHRONOUS"	"SYSTEM_SYNCHRONOUS"	Sets configuration bits affecting the clock delay alignment between the DCM_SP output clocks and an FPGA clock input pin.
DFS_FREQUENCY_MODE	String	"LOW", "HIGH"	"LOW"	This is a legacy attribute. The DCM is always in the automatic frequency search mode. Setting High or Low makes no effect.
DLL_FREQUENCY_MODE	String	"LOW", "HIGH"	"LOW"	This is a legacy attribute. The DCM is always in the automatic frequency search mode. Setting High or Low makes no effect.
DUTY_CYCLE_CORRECTION	Boolean	TRUE, FALSE	TRUE	Unsupported
FACTORY_JF	Hexadecimal	16'h8080 to 16'hffff	16'hc080	Unsupported
PHASE_SHIFT	Integer	-255 to 255	0	The PHASE_SHIFT attribute is applicable only if the CLKOUT_PHASE_SHIFT attribute is set to FIXED or VARIABLE. Defines the rising-edge skew between CLKIN and all the DCM clock outputs at configuration and consequently phase shifts the DCM clock outputs. The skew or phase shift value is specified as an integer that represents a fraction of the clock period as expressed in the equations in Fine Phase Shifting. Actual allowable values depends on input clock frequency. The actual range is less when $TCLKIN > FINE\_SHIFT\_RANGE$ . The FINE_SHIFT_RANGE specification represents the total delay of all taps in the delay line.

Attribute	Data Type	Allowed_Values	Default	Description
STARTUP_WAIT	Boolean	FALSE, TRUE	FALSE	<p>Controls whether the FPGA configuration signal DONE waits for the DCM to assert its LOCKED signal before going High.</p> <ul style="list-style-type: none"> <li>FALSE - Default. DONE is asserted at the end of configuration without waiting for the DCM to assert LOCKED.</li> <li>TRUE - The DONE signal does not transition High until the LOCKED signal transitions High on the associated DCM.</li> </ul> <p>STARTUP_WAIT does not prevent LOCKED from transitioning High. The FPGA startup sequence must also be modified to insert a LCK (lock) cycle before the postponed cycle. The DONE cycle or the GWE cycle are typical choices. When more than one DCM is configured, the FPGA waits until all DCMs are LOCKED.</p>

## For More Information

- See the [Spartan-6 FPGA Clocking Resources User Guide \(UG382\)](#).
- See the [Spartan-6 FPGA Data Sheet: DC and Switching Characteristics \(DS162\)](#).

## DEC\_CC16

### Macro: 16-Bit Active Low Decoder

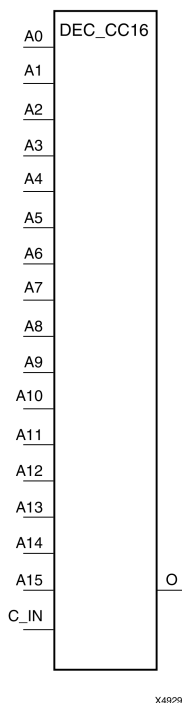

### Introduction

This design element is a 16-bit decoder that is used to build wide-decoder functions. It is implemented by cascading CY\_MUX elements driven by look-up tables (LUTs). The C\_IN pin can only be driven by the output (O) of a previous decode stage. When one or more of the inputs (A) are Low, the output is Low. When all the inputs are High and the C\_IN input is High, the output is High. You can decode patterns by adding inverters to inputs.

### Logic Table

Inputs					Outputs
A0	A1	...	Az	C_IN	O
1	1	1	1	1	1
X	X	X	X	0	0
0	X	X	X	X	0
X	0	X	X	X	0
X	X	X	0	X	0

*z = 3 for DEC\_CC4; z = 7 for DEC\_CC8; z = 15 for DEC\_CC16*

### Design Entry Method

This design element is only for use in schematics.

### For More Information

See the [Spartan-6 FPGA User Documentation \(User Guides and Data Sheets\)](#).



## DEC\_CC4

### Macro: 4-Bit Active Low Decoder

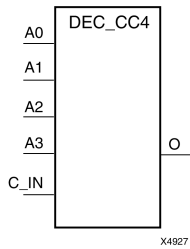

## Introduction

This design element is a 4-bit decoder that is used to build wide-decoder functions. It is implemented by cascading CY\_MUX elements driven by look-up tables (LUTs). The C\_IN pin can only be driven by the output (O) of a previous decode stage. When one or more of the inputs (A) are Low, the output is Low. When all the inputs are High and the C\_IN input is High, the output is High. You can decode patterns by adding inverters to inputs.

## Logic Table

Inputs					Outputs
A0	A1	...	Az	C_IN	O
1	1	1	1	1	1
X	X	X	X	0	0
0	X	X	X	X	0
X	0	X	X	X	0
X	X	X	0	X	0

z = 3 for DEC\_CC4; z = 7 for DEC\_CC8; z = 15 for DEC\_CC16

## Design Entry Method

This design element is only for use in schematics.

## For More Information

See the [Spartan-6 FPGA User Documentation \(User Guides and Data Sheets\)](#).

## DEC\_CC8

### Macro: 8-Bit Active Low Decoder

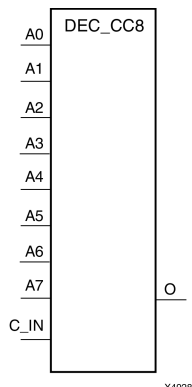

## Introduction

This design element is a 8-bit decoder that is used to build wide-decoder functions. It is implemented by cascading CY\_MUX elements driven by look-up tables (LUTs). The C\_IN pin can only be driven by the output (O) of a previous decode stage. When one or more of the inputs (A) are Low, the output is Low. When all the inputs are High and the C\_IN input is High, the output is High. You can decode patterns by adding inverters to inputs.

## Logic Table

Inputs					Outputs
A0	A1	...	Az	C_IN	O
1	1	1	1	1	1
X	X	X	X	0	0
0	X	X	X	X	0
X	0	X	X	X	0
X	X	X	0	X	0

*z = 3 for DEC\_CC4; z = 7 for DEC\_CC8; z = 15 for DEC\_CC16*

## Design Entry Method

This design element is only for use in schematics.

## For More Information

See the [Spartan-6 FPGA User Documentation \(User Guides and Data Sheets\)](#).

# DECODE16

## Macro: 16-Bit Active-Low Decoder

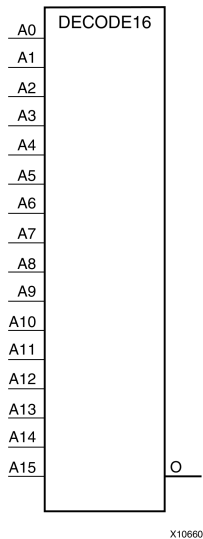

### Introduction

This design element is a 4-bit, active-low decoder that is implemented using combinations of LUTs and MUXCYs.

### Logic Table

Inputs				Outputs*
A0	A1	...	Az	O
1	1	1	1	1
0	X	X	X	0
X	0	X	X	0
X	X	X	0	0

z = bitwidth -1

\*A pull-up resistor must be connected to the output to establish High-level drive current.

### Design Entry Method

This design element is only for use in schematics.

### For More Information

See the [Spartan-6 FPGA User Documentation \(User Guides and Data Sheets\)](#).

## DECODE32

### Macro: 32-Bit Active-Low Decoder

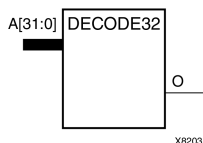

## Introduction

This design element is a 32-bit active-low decoder that is implemented using combinations of LUTs and MUXCYs.

## Logic Table

Inputs				Outputs
A0	A1	...	Az	O
1	1	1	1	1
0	X	X	X	0
X	0	X	X	0
X	X	X	0	0

*z = 31 for DECODE32, z = 63 for DECODE64*

## Design Entry Method

This design element is only for use in schematics.

## For More Information

See the [Spartan-6 FPGA User Documentation \(User Guides and Data Sheets\)](#).

## DECODE4

### Macro: 4-Bit Active-Low Decoder

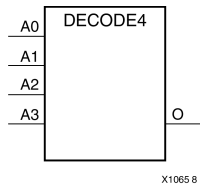

### Introduction

This design element is a 4-bit, active-low decoder that is implemented using combinations of LUTs and MUXCYs.

### Logic Table

Inputs				Outputs*
A0	A1	...	Az	O
1	1	1	1	1
0	X	X	X	0
X	0	X	X	0
X	X	X	0	0

z = bitwidth -1

\*A pull-up resistor must be connected to the output to establish High-level drive current.

### Design Entry Method

This design element is only for use in schematics.

### For More Information

See the [Spartan-6 FPGA User Documentation \(User Guides and Data Sheets\)](#).

## DECODE64

### Macro: 64-Bit Active-Low Decoder

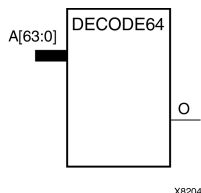

## Introduction

This design element is a 64-bit active-low decoder that is implemented using combinations of LUTs and MUXCYs.

## Logic Table

Inputs				Outputs
A0	A1	...	Az	O
1	1	1	1	1
0	X	X	X	0
X	0	X	X	0
X	X	X	0	0

z = 31 for DECODE32, z = 63 for DECODE64

## Design Entry Method

This design element is only for use in schematics.

## For More Information

See the [Spartan-6 FPGA User Documentation \(User Guides and Data Sheets\)](#).

## DECODE8

### Macro: 8-Bit Active-Low Decoder

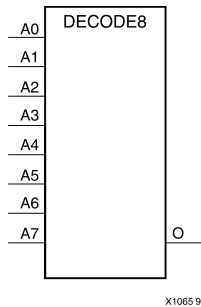

## Introduction

This design element is a 8-bit, active-low decoder that is implemented using combinations of LUTs and MUXCY's.

## Logic Table

Inputs				Outputs*
A0	A1	...	Az	O
1	1	1	1	1
0	X	X	X	0
X	0	X	X	0
X	X	X	0	0

z = bitwidth -1

\*A pull-up resistor must be connected to the output to establish High-level drive current.

## Design Entry Method

This design element is only for use in schematics.

## For More Information

See the [Spartan-6 FPGA User Documentation \(User Guides and Data Sheets\)](#).

## DNA\_PORT

### Primitive: Device DNA Data Access Port

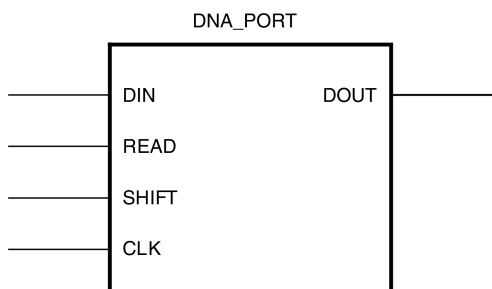

X11148

## Introduction

This element allows access to a dedicated shift register that can be loaded with the Device DNA data bits (unique ID) for a given device. In addition to shifting out the DNA data bits, this component allows for the inclusion of supplemental bits of your data, or allows for the DNA data to rollover (repeat DNA data after initial data has been shifted out). This component is primarily used in conjunction with other circuitry to build added copy protection for the FPGA bitstream from possible theft. Connect all inputs and outputs to the design to ensure proper operation. To access the Device DNA data, you must first load the shift register by setting the active high READ signal for one clock cycle. After the shift register is loaded, the data can be synchronously shifted out by enabling the active high SHIFT input and capturing the data out the DOUT output port. Additional data can be appended to the end of the 57-bit shift register by connecting the appropriate logic to the DIN port. If DNA data rollover is desired, connect the DOUT port directly to the DIN port to allow for the same data to be shifted out after completing the 57-bit shift operation. If no additional data is necessary, the DIN port can be tied to a logic zero. The attribute SIM\_DNA\_VALUE can be optionally set to allow for simulation of a possible DNA data sequence. By default, the Device DNA data bits are all zeros in the simulation model.

## Port Descriptions

Port	Direction	Width	Function
CLK	Input	1	Clock input.
DIN	Input	1	User data input pin.
DOUT	Output	1	DNA output data.
READ	Input	1	Active high load DNA, active low read input.
SHIFT	Input	1	Active high shift enable input.

## Design Entry Method

This design element can be used in schematics.

Connect all inputs and outputs to the design to ensure proper operation.

## Available Attributes

Attribute	Data Type	Allowed Values	Default	Description
SIM_DNA_VALUE	Hexa-decimal	57'h00000000 0000000 to 57'h1fffffffffffff	57'h00000000 0000000	Specifies the Pre-programmed factory ID value.



## For More Information

- See the [Spartan-6 FPGA Configuration User Guide \(UG380\)](#).
- See the [Spartan-6 FPGA Data Sheet: DC and Switching Characteristics \(DS162\)](#).
- See the [Spartan-6 FPGA User Documentation \(User Guides and Data Sheets\)](#).

## DSP48A1

Primitive: Multi-Functional, Cascadable, 48-bit Output, Arithmetic Block

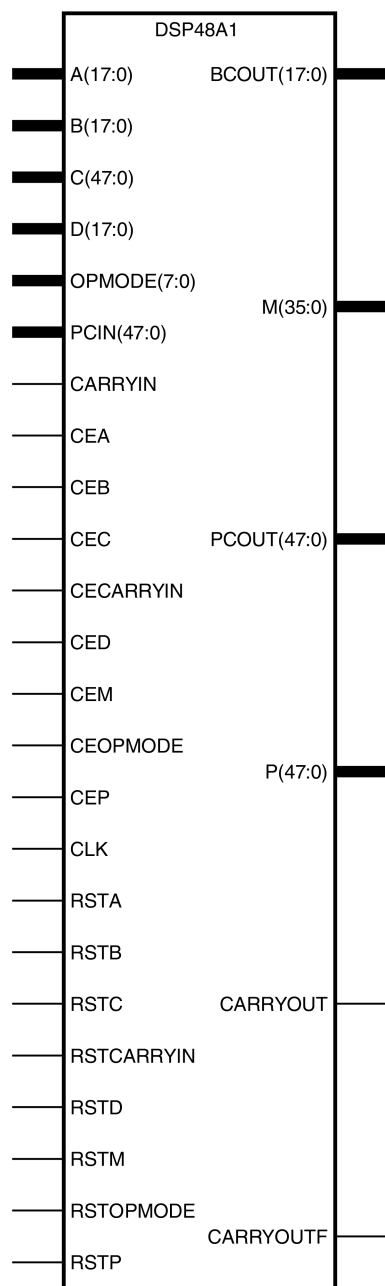

X11138

## Introduction

This element is a versatile, scalable, hard IP block that allows for the creation of compact, high-speed, arithmetic-intensive operations, such as those seen for many DSP algorithms. The block consists of a configurable, 18-bit, pre-add/sub, followed by an 18x18 signed multiplier, followed by a 48-bit post-add/sub/accum. Several configurable pipeline registers exist within the block, allowing for higher clock speeds with the trade-off of added latency. Opmode pins allow the block operation to change from one clock-cycle to the next, thus allowing a single block to serve several arithmetic functions within a design. Multiple DSP48A1 blocks can be cascaded to form larger multiplication and addition functions. See the [Spartan-6 FPGA DSP48A1 Slice User Guide \(UG389\)](#) for additional details on the use of this element.

## Port Descriptions

Port	Direction	Width	Function
A[17:0]	Input	18	18-bit data input to the multiplier or the post add/sub depending on the value of OPMODE[1:0].
B[17:0]	Input	18	18-bit data input to the multiplier, the pre-add/sub, and optionally to the post-add/sub depending on the value of OPMODE[1:0].
BCOUT[17:0]	Output	18	Cascade output for Port B. If used, connect to the B port of downstream cascaded DSP48A1. If not used, leave unconnected.
C[47:0]	Input	48	48-bit data input to post-add/sub.
CARRYIN	Input	1	External carry input to the post-add/sub. Connect only to the CARRYOUT pin of another DSP48A1 block.
CARRYOUT	Output	1	Carry out signal for the post-add/sub. Connect only to the CARRYIN pin of another DSP48A1.
CARRYOUTF	Output	1	Carry out signal for the post-add/sub that can be routed into the fabric.
CEA	Input	1	Active high clock enable for the A port registers (A0REG=1 or A1REG=1). Tie to logic one if not used and A0REG=1 or A1REG=1. Tie to logic zero if A0REG=0 and A1REG=0.
CEB	Input	1	Active high clock enable for the B port registers (B0REG=1 or B1REG=1). Tie to logic one if not used and B0REG=1 or B1REG=1. Tie to logic zero if B0REG=0 and B1REG=0.
CEC	Input	1	Active high clock enable for the C port registers (CREG=1). Tie to logic one if not used and CREG=1. Tie to logic zero if CREG=0.
CECARRYIN	Input	1	Active high, clock enable for the carry-in registers (CARRYINREG=1). Tie to logic one if not used and CARRYINREG=1. Tie to a logic zero if CARRYINREG=0.
CED	Input	1	Active high clock enable for the D port registers (DREG=1). Tie to logic one if not used and DREG=1. Tie to logic zero if DREG=0.
CEM	Input	1	Active high clock enable for the multiplier registers (MREG=1). Tie to logic one if not used and MREG=1. Tie to logic zero if MREG=0.
CEOPMODE	Input	1	Active high clock enable for the OPMODE input registers (OPMODEREG=1). Tie to logic one if not used and OPMODEREG=1. Tie to logic zero if OPMODEREG=0.
CEP	Input	1	Active high, clock enable for the output port registers (PREG=1). Tie to logic one if not used and PREG=1. Tie to logic zero if PREG=0.
CLK	Input	1	DSP48A1 clock
D[17:0]	Input	18	18-bit data input to the pre-add/sub.
M[35:0]	Output	36	Direct multiplier data output to fabric. Do not use if P is used.

Port	Direction	Width	Function
OPMODE	Input	8	<p>Control input to select the arithmetic operations of the DSP48A1.</p> <ul style="list-style-type: none"> <li>• OPMODE[1:0] - Specifies the source of the X input to the post-add/sub. <ul style="list-style-type: none"> <li>- 0 - Specifies to place all zeros (disable the post-add/sub).</li> <li>- 1 - Use the multiplier product.</li> <li>- 2 - Use the POUT output signal.</li> <li>- 3 - Use the concatenated D, B, A input signals.</li> </ul> </li> <li>• OPMODE[3:2] - Specifies the source of the Z input to the post-add/sub. <ul style="list-style-type: none"> <li>- 0 - Disable the post-add/sub and propagate the multiplier product to POUT.</li> <li>- 1 - Use PCIN.</li> <li>- 2 - Use the POUT port (accumulator).</li> <li>- 3 - Use the C port.</li> </ul> </li> <li>• OPMODE[4] - Specifies the use of the pre-add/sub <ul style="list-style-type: none"> <li>- 0 - Bypass the pre-adder, supplying the data on Port B directly to the multiplier.</li> <li>- 1 - Use the pre-adder, adding or subtracting the values on the B and D ports prior to the multiplier.</li> </ul> </li> <li>• OPMODE[5] - Force a value on carry-in to the post-adder. Only applicable when CARRYINSEL = OPMODE5.</li> <li>• OPMODE[6] - Specifies whether the pre-add/sub is an adder or subtracter <ul style="list-style-type: none"> <li>- 0 - Specifies pre-add/sub to perform an addition operation.</li> <li>- 1 - Specifies pre-add/sub to perform a subtract operation.</li> </ul> </li> <li>• OPMODE[7] - Specifies whether the post-add/sub is an adder or subtracter <ul style="list-style-type: none"> <li>- 0 - Specifies post-add/sub to perform an addition operation.</li> <li>- 1 - Specifies post-add/sub to perform a subtract operation.</li> </ul> </li> </ul>
P[47:0]	Output	48	Primary data output.
PCIN[47:0]	Input	48	Cascade input for Port P. If used, connect to PCOUT of upstream cascaded DSP48A1. If not used, tie port to all zeros.
PCOUT[47:0]	Output	48	Cascade output for Port P. If used, connect to PCIN of downstream cascaded DSP48A1. If not used, leave unconnected.
RSTA	Input	1	Active high reset for the A port registers (A0REG=1 or A1REG=1). Tie to logic zero if not used. This reset is configurable to be synchronous or asynchronous, depending on the value of the RSTTYPE attribute.
RSTB	Input	1	Active high reset for the B port registers (B0REG=1 or B1REG=1). Tie to logic zero if not used. This reset is configurable to be synchronous or asynchronous, depending on the value of the RSTTYPE attribute.
RSTC	Input	1	Active high reset for the C port registers (CREG=1). Tie to logic zero if not used. This reset is configurable to be synchronous or asynchronous depending on the value of the RSTTYPE attribute.

Port	Direction	Width	Function
RSTCARRYIN	Input	1	Active high reset for the carry-in register (CARRYINREG =1). Tie to logic zero if not used. This reset is configurable to be synchronous or asynchronous depending on the value of the RSTTYPE attribute.
RSTD	Input	1	Active high reset for the D port registers (DREG=1). Tie to logic zero if not used. This reset is configurable to be synchronous or asynchronous depending on the value of the RSTTYPE attribute.
RSTM	Input	1	Active high reset for the multiplier registers (MREG=1). Tie to logic zero if not used. This reset is configurable to be synchronous or asynchronous depending on the value of the RSTTYPE attribute.
RSTOPMODE	Input	1	Active high reset for the OPMODE registers (OPMODEREG=1). Tie to logic zero if not used. This reset is configurable to be synchronous or asynchronous depending on the value of the RSTTYPE attribute.
RSTP	Input	1	Active high, reset for the P output registers (PREG=1). Tie to logic zero if not used. This reset is configurable to be synchronous or asynchronous depending on the value of the RSTTYPE attribute.

## Design Entry Method

This design element can be used in schematics.

## Available Attributes

Attribute	Data Type	Allowed Values	Default	Description
AOREG	Integer	0, 1	0	Selects usage of first stage A input pipeline registers. Set to 1 to use the first stage A pipeline registers.
AIREG	Integer	1, 0	1	Selects usage of second stage A input pipeline registers. Set to 1 to use the second stage A pipeline registers.
BOREG	Integer	0, 1	0	Selects usage of first stage B input pipeline registers. Set to 1 to use the first stage B pipeline registers.
BIREG	Integer	1, 0	1	Selects usage of second stage B input pipeline registers. Set to 1 to use the second stage B pipeline registers. The second stage B pipeline registers are after the pre-adder circuit.
CARRYINREG	Integer	1, 0	1	Selects usage of the CARRYIN input pipeline registers. Set to 1 to use the CARRYIN pipeline registers.
CARRYINSEL	String	"CARRYIN", "OPMODE5"	"OPMODE5"	Selects whether the post add/sub carry-in signal should be sourced from the CARRYIN pin (connected to the CARRYOUT of another DSP48A1) or dynamically controlled from the FPGA fabric by the OPMODE[5] input.
CARRYOUTREG	Integer	1, 0	1	Selects usage of CARRYOUT output pipeline registers. Set to 1 to use the CARRYOUT pipeline registers. The registered outputs will include CARRYOUT and CARRYOUTF.
CREG	Integer	1, 0	1	Selects usage of the C input pipeline registers. Set to 1 to use the C pipeline registers.

Attribute	Data Type	Allowed Values	Default	Description
DREG	Integer	1, 0	1	Selects usage of D pre-adder input pipeline registers. Set to 1 to use the D pipeline registers.
MREG	Integer	1, 0	1	Selects usage of M multiplier output pipeline registers. Set to 1 to use the M pipeline registers.
OPMODEREG	Integer	1, 0	1	Selects usage of OPMODE input pipeline registers. Set to 1 to use the OPMODE pipeline registers.
PREG	Integer	1, 0	1	Selects usage of P output pipeline registers. Set to 1 to use the P pipeline registers. The registered outputs will include P and PCOUT.
RSTTYPE	String	"SYNC", "ASYNC"	"SYNC"	Selects whether all resets for the DSP48A1 should have a synchronous or asynchronous reset capability. Due to improved timing and circuit stability, it is recommended to always have this set to 'SYNC' unless an asynchronous reset is absolutely necessary.

## For More Information

- See the [Spartan-6 FPGA Data Sheet: DC and Switching Characteristics \(DS162\)](#).
- See the [Spartan-6 FPGA DSP48A1 Slice User Guide \(UG389\)](#).

## FD

### Primitive: D Flip-Flop

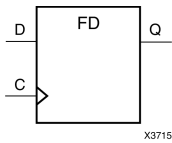

## Introduction

This design element is a D-type flip-flop with data input (D) and data output (Q). The data on the D inputs is loaded into the flip-flop during the Low-to-High clock (C) transition.

This flip-flop is asynchronously cleared, outputs Low, when power is applied. For FPGA devices, power-on conditions are simulated when global set/reset (GSR) is active. GSR defaults to active-High but can be inverted by adding an inverter in front of the GSR input of the appropriate `STARTUP_architecture` symbol.

## Logic Table

Inputs		Outputs
D	C	Q
0	↑	0
1	↑	1

## Design Entry Method

This design element is only for use in schematics.

## Available Attributes

Attribute	Data Type	Allowed Values	Default	Description
INIT	Binary	0, 1	0	Sets the initial value of Q output after configuration

## For More Information

See the [Spartan-6 FPGA User Documentation \(User Guides and Data Sheets\)](#).

## FD\_1

### Primitive: D Flip-Flop with Negative-Edge Clock

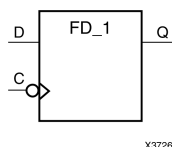

## Introduction

This design element is a single D-type flip-flop with data input (D) and data output (Q). The data on the (D) input is loaded into the flip-flop during the High-to-Low clock (C) transition.

This flip-flop is asynchronously cleared, outputs Low, when power is applied. For FPGA devices, power-on conditions are simulated when global set/reset (GSR) is active. GSR defaults to active-High but can be inverted by adding an inverter in front of the GSR input of the appropriate *STARTUP\_architecture* symbol.

## Logic Table

Inputs		Outputs
D	C	Q
0	↓	0
1	↓	1

## Design Entry Method

This design element is only for use in schematics.

## Available Attributes

Attribute	Data Type	Allowed Values	Default	Description
INIT	Binary	0, 1	0	Sets the initial value of Q output after configuration

## For More Information

See the [Spartan-6 FPGA User Documentation \(User Guides and Data Sheets\)](#).



# FD16CE

## Macro: 16-Bit Data Register with Clock Enable and Asynchronous Clear

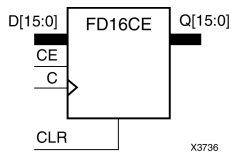

### Introduction

This design element is a 16-bit data register with clock enable and asynchronous clear. When clock enable (CE) is High and asynchronous clear (CLR) is Low, the data on the data inputs (D) is transferred to the corresponding data outputs (Q) during the Low-to-High clock (C) transition. When CLR is High, it overrides all other inputs and resets the data outputs (Q) Low. When CE is Low, clock transitions are ignored.

This register is asynchronously cleared, outputs Low, when power is applied. For FPGA devices, power-on conditions are simulated when global set/reset (GSR) is active. GSR defaults to active-High but can be inverted by adding an inverter in front of the GSR input of the appropriate *STARTUP\_architecture* symbol.

### Logic Table

Inputs				Outputs
CLR	CE	Dz : D0	C	Qz : Q0
1	X	X	X	0
0	0	X	X	No Change
0	1	Dn	↑	Dn

z = bit-width - 1

### Design Entry Method

This design element is only for use in schematics.

### For More Information

See the [Spartan-6 FPGA User Documentation \(User Guides and Data Sheets\)](#).

## FD16RE

### Macro: 16-Bit Data Register with Clock Enable and Synchronous Reset

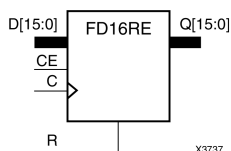

## Introduction

This design element is a 16-bit data registers. When the clock enable (CE) input is High, and the synchronous reset (R) input is Low, the data on the data inputs (D) is transferred to the corresponding data outputs (Q0) during the Low-to-High clock (C) transition. When R is High, it overrides all other inputs and resets the data outputs (Q) Low on the Low-to-High clock transition. When CE is Low, clock transitions are ignored.

This register is asynchronously cleared, outputs Low, when power is applied. For FPGA devices, power-on conditions are simulated when global set/reset (GSR) is active. GSR defaults to active-High but can be inverted by adding an inverter in front of the GSR input of the appropriate *STARTUP\_architecture* symbol.

## Logic Table

Inputs				Outputs
R	CE	Dz : D0	C	Qz : Q0
1	X	X	↑	0
0	0	X	X	No Change
0	1	Dn	↑	Dn

z = bit-width - 1

## Design Entry Method

This design element is only for use in schematics.

## For More Information

See the [Spartan-6 FPGA User Documentation \(User Guides and Data Sheets\)](#).

# FD4CE

## Macro: 4-Bit Data Register with Clock Enable and Asynchronous Clear

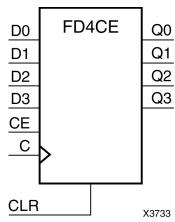

### Introduction

This design element is a 4-bit data register with clock enable and asynchronous clear. When clock enable (CE) is High and asynchronous clear (CLR) is Low, the data on the data inputs (D) is transferred to the corresponding data outputs (Q) during the Low-to-High clock (C) transition. When CLR is High, it overrides all other inputs and resets the data outputs (Q) Low. When CE is Low, clock transitions are ignored.

This register is asynchronously cleared, outputs Low, when power is applied. For FPGA devices, power-on conditions are simulated when global set/reset (GSR) is active. GSR defaults to active-High but can be inverted by adding an inverter in front of the GSR input of the appropriate *STARTUP\_architecture* symbol.

### Logic Table

Inputs				Outputs
CLR	CE	Dz : D0	C	Qz : Q0
1	X	X	X	0
0	0	X	X	No Change
0	1	Dn	↑	Dn

z = bit-width - 1

### Design Entry Method

This design element is only for use in schematics.

### For More Information

See the [Spartan-6 FPGA User Documentation \(User Guides and Data Sheets\)](#).

## FD4RE

### Macro: 4-Bit Data Register with Clock Enable and Synchronous Reset

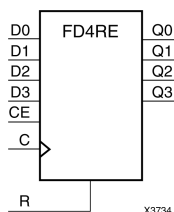

## Introduction

This design element is a 4-bit data registers. When the clock enable (CE) input is High, and the synchronous reset (R) input is Low, the data on the data inputs (D) is transferred to the corresponding data outputs (Q0) during the Low-to-High clock (C) transition. When R is High, it overrides all other inputs and resets the data outputs (Q) Low on the Low-to-High clock transition. When CE is Low, clock transitions are ignored.

This register is asynchronously cleared, outputs Low, when power is applied. For FPGA devices, power-on conditions are simulated when global set/reset (GSR) is active. GSR defaults to active-High but can be inverted by adding an inverter in front of the GSR input of the appropriate `STARTUP_architecture` symbol.

## Logic Table

Inputs				Outputs
R	CE	Dz : D0	C	Qz : Q0
1	X	X	↑	0
0	0	X	X	No Change
0	1	Dn	↑	Dn

z = bit-width - 1

## Design Entry Method

This design element is only for use in schematics.

## For More Information

See the [Spartan-6 FPGA User Documentation \(User Guides and Data Sheets\)](#).

## FD8CE

### Macro: 8-Bit Data Register with Clock Enable and Asynchronous Clear

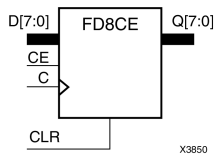

## Introduction

This design element is a 8-bit data register with clock enable and asynchronous clear. When clock enable (CE) is High and asynchronous clear (CLR) is Low, the data on the data inputs (D) is transferred to the corresponding data outputs (Q) during the Low-to-High clock (C) transition. When CLR is High, it overrides all other inputs and resets the data outputs (Q) Low. When CE is Low, clock transitions are ignored.

This register is asynchronously cleared, outputs Low, when power is applied. For FPGA devices, power-on conditions are simulated when global set/reset (GSR) is active. GSR defaults to active-High but can be inverted by adding an inverter in front of the GSR input of the appropriate `STARTUP_architecture` symbol.

## Logic Table

Inputs				Outputs
CLR	CE	Dz : D0	C	Qz : Q0
1	X	X	X	0
0	0	X	X	No Change
0	1	Dn	↑	Dn

z = bit-width - 1

## Design Entry Method

This design element is only for use in schematics.

## For More Information

See the [Spartan-6 FPGA User Documentation \(User Guides and Data Sheets\)](#).

## FD8RE

### Macro: 8-Bit Data Register with Clock Enable and Synchronous Reset

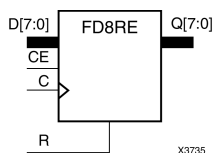

## Introduction

This design element is an 8-bit data register. When the clock enable (CE) input is High, and the synchronous reset (R) input is Low, the data on the data inputs (D) is transferred to the corresponding data outputs (Q) during the Low-to-High clock (C) transition. When R is High, it overrides all other inputs and resets the data outputs (Q) Low on the Low-to-High clock transition. When CE is Low, clock transitions are ignored.

This register is asynchronously cleared, outputs Low, when power is applied. For FPGA devices, power-on conditions are simulated when global set/reset (GSR) is active. GSR defaults to active-High but can be inverted by adding an inverter in front of the GSR input of the appropriate *STARTUP\_architecture* symbol.

## Logic Table

Inputs				Outputs
R	CE	Dz : D0	C	Qz : Q0
1	X	X	↑	0
0	0	X	X	No Change
0	1	Dn	↑	Dn

z = bit-width - 1

## Design Entry Method

This design element is only for use in schematics.

## For More Information

See the [Spartan-6 FPGA User Documentation \(User Guides and Data Sheets\)](#).

## FDC

### Primitive: D Flip-Flop with Asynchronous Clear

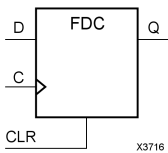

## Introduction

This design element is a single D-type flip-flop with data (D) and asynchronous clear (CLR) inputs and data output (Q). The asynchronous CLR, when High, overrides all other inputs and sets the (Q) output Low. The data on the (D) input is loaded into the flip-flop when CLR is Low on the Low-to-High clock transition.

This flip-flop is asynchronously cleared, outputs Low, when power is applied. For FPGA devices, power-on conditions are simulated when global set/reset (GSR) is active. GSR defaults to active-High but can be inverted by adding an inverter in front of the GSR input of the appropriate `STARTUP_architecture` symbol.

## Logic Table

Inputs			Outputs
CLR	D	C	Q
1	X	X	0
0	D	↑	D

## Design Entry Method

This design element is only for use in schematics.

## Available Attributes

Attribute	Data Type	Allowed Values	Default	Description
INIT	Binary	0, 1	0	<p>Sets the initial value of Q output after configuration</p> <p>For Spartan®-6, the INIT value should always match the polarity of the set or reset. For this element, the INIT should be 0. If set to 1, an asynchronous circuit must be created to exhibit this behavior, which Xilinx does not recommend.</p>

## For More Information

See the [Spartan-6 FPGA User Documentation \(User Guides and Data Sheets\)](#).

## FDC\_1

### Primitive: D Flip-Flop with Negative-Edge Clock and Asynchronous Clear

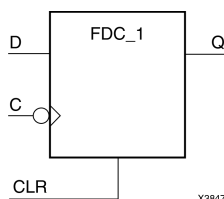

## Introduction

FDC\_1 is a single D-type flip-flop with data input (D), asynchronous clear input (CLR), and data output (Q). The asynchronous CLR, when active, overrides all other inputs and sets the (Q) output Low. The data on the (D) input is loaded into the flip-flop during the High-to-Low clock (C) transition.

This flip-flop is asynchronously cleared, outputs Low, when power is applied. For FPGA devices, power-on conditions are simulated when global set/reset (GSR) is active. GSR defaults to active-High but can be inverted by adding an inverter in front of the GSR input of the appropriate *STARTUP\_architecture* symbol.

## Logic Table

Inputs			Outputs
CLR	D	C	Q
1	X	X	0
0	D	↓	D

## Design Entry Method

This design element is only for use in schematics.

## Available Attributes

Attribute	Data Type	Allowed Values	Default	Description
INIT	Binary	0, 1	0	<p>Sets the initial value of Q output after configuration</p> <p>For Spartan®-6, the INIT value should always match the polarity of the set or reset. For this element, the INIT should be 0. If set to 1, an asynchronous circuit must be created to exhibit this behavior, which Xilinx does not recommend.</p>

## For More Information

See the [Spartan-6 FPGA User Documentation \(User Guides and Data Sheets\)](#).



## FDCE

### Primitive: D Flip-Flop with Clock Enable and Asynchronous Clear

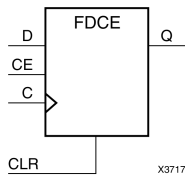

## Introduction

This design element is a single D-type flip-flop with clock enable and asynchronous clear. When clock enable (CE) is High and asynchronous clear (CLR) is Low, the data on the data input (D) of this design element is transferred to the corresponding data output (Q) during the Low-to-High clock (C) transition. When CLR is High, it overrides all other inputs and resets the data output (Q) Low. When CE is Low, clock transitions are ignored.

This flip-flop is asynchronously cleared, outputs Low, when power is applied. For FPGA devices, power-on conditions are simulated when global set/reset (GSR) is active. GSR defaults to active-High but can be inverted by adding an inverter in front of the GSR input of the appropriate STARTUP\_architecture symbol.

## Logic Table

Inputs				Outputs
CLR	CE	D	C	Q
1	X	X	X	0
0	0	X	X	No Change
0	1	D	↑	D

## Design Entry Method

This design element can be used in schematics.

## Available Attributes

Attribute	Data Type	Allowed Values	Default	Description
INIT	Binary	0, 1	0	Sets the initial value of Q output after configuration  For Spartan®-6, the INIT value should always match the polarity of the set or reset. For this element, the INIT should be 0. If set to 1, an asynchronous circuit must be created to exhibit this behavior, which Xilinx does not recommend.

## For More Information

- See the [Spartan-6 FPGA Configurable Logic Block User Guide \(UG384\)](#).
- See the [Spartan-6 FPGA Data Sheet: DC and Switching Characteristics \(DS162\)](#).

## FDCE\_1

Primitive: D Flip-Flop with Negative-Edge Clock, Clock Enable, and Asynchronous Clear

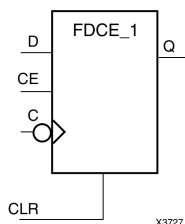

### Introduction

This design element is a single D-type flip-flop with data (D), clock enable (CE), asynchronous clear (CLR) inputs, and data output (Q). The asynchronous CLR input, when High, overrides all other inputs and sets the Q output Low. The data on the (D) input is loaded into the flip-flop when CLR is Low and CE is High on the High-to-Low clock (C) transition. When CE is Low, the clock transitions are ignored.

This flip-flop is asynchronously cleared, outputs Low, when power is applied. For FPGA devices, power-on conditions are simulated when global set/reset (GSR) is active. GSR defaults to active-High but can be inverted by adding an inverter in front of the GSR input of the appropriate `STARTUP_architecture` symbol.

### Logic Table

Inputs				Outputs
CLR	CE	D	C	Q
1	X	X	X	0
0	0	X	X	No Change
0	1	D	↓	D

### Design Entry Method

This design element can be used in schematics.

### Available Attributes

Attribute	Data Type	Allowed Values	Default	Description
INIT	Binary	0, 1	0	<p>Sets the initial value of Q output after configuration</p> <p>For Spartan®-6, the INIT value should always match the polarity of the set or reset. For this element, the INIT should be 0. If set to 1, an asynchronous circuit must be created to exhibit this behavior, which Xilinx does not recommend.</p>

### For More Information

See the [Spartan-6 FPGA User Documentation \(User Guides and Data Sheets\)](#).

## FDE

### Primitive: D Flip-Flop with Clock Enable

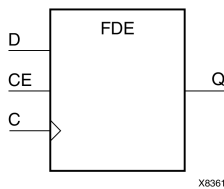

## Introduction

This design element is a single D-type flip-flop with data input (D), clock enable (CE), and data output (Q). When clock enable is High, the data on the (D) input is loaded into the flip-flop during the Low-to-High clock (C) transition.

This flip-flop is asynchronously cleared, outputs Low, when power is applied. For FPGA devices, power-on conditions are simulated when global set/reset (GSR) is active. GSR defaults to active-High but can be inverted by adding an inverter in front of the GSR input of the appropriate `STARTUP_architecture` symbol.

## Logic Table

Inputs			Outputs
CE	D	C	Q
0	X	X	No Change
1	0	↑	0
1	1	↑	1

## Design Entry Method

This design element is only for use in schematics.

## Available Attributes

Attribute	Data Type	Allowed Values	Default	Description
INIT	Binary	0, 1	0	Sets the initial value of Q output after configuration

## For More Information

See the [Spartan-6 FPGA User Documentation \(User Guides and Data Sheets\)](#).

## FDE\_1

### Primitive: D Flip-Flop with Negative-Edge Clock and Clock Enable

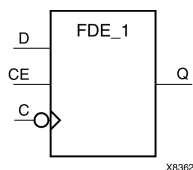

## Introduction

This design element is a single D-type flip-flop with data input (D), clock enable (CE), and data output (Q). When clock enable is High, the data on the (D) input is loaded into the flip-flop during the High-to-Low clock (C) transition.

This flip-flop is asynchronously cleared, outputs Low, when power is applied. For FPGA devices, power-on conditions are simulated when global set/reset (GSR) is active. GSR defaults to active-High but can be inverted by adding an inverter in front of the GSR input of the appropriate `STARTUP_architecture` symbol.

## Logic Table

Inputs			Outputs
CE	D	C	Q
0	X	X	No Change
1	0	↓	0
1	1	↓	1

## Design Entry Method

This design element is only for use in schematics.

## Available Attributes

Attribute	Data Type	Allowed Values	Default	Description
INIT	Binary	0, 1	0	Sets the initial value of Q output after configuration

## For More Information

See the [Spartan-6 FPGA User Documentation \(User Guides and Data Sheets\)](#).

# FDP

## Primitive: D Flip-Flop with Asynchronous Preset

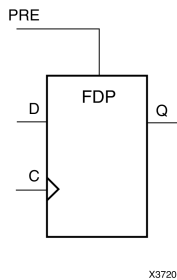

## Introduction

This design element is a single D-type flip-flop with data (D) and asynchronous preset (PRE) inputs and data output (Q). The asynchronous PRE, when High, overrides all other inputs and presets the (Q) output High. The data on the (D) input is loaded into the flip-flop when PRE is Low on the Low-to-High clock (C) transition.

For FPGA devices, this flip-flop is asynchronously preset, output High, when power is applied. Power-on conditions are simulated when global set/reset (GSR) is active. GSR defaults to active-High but can be inverted by adding an inverter in front of the GSR input of the appropriate `STARTUP_architecture` symbol.

## Logic Table

Inputs			Outputs
PRE	C	D	Q
1	X	X	1
0	↑	D	D

## Design Entry Method

This design element is only for use in schematics.

## Available Attributes

Attribute	Data Type	Allowed Values	Default	Description
INIT	Binary	0, 1	1	Sets the initial value of Q output after configuration  For Spartan®-6, Xilinx recommends that the INIT value always matches the polarity of the set or reset. For this element, the INIT should be 1. If set to 0, additional asynchronous circuitry will be created to correctly model the behavior.

## For More Information

See the [Spartan-6 FPGA User Documentation \(User Guides and Data Sheets\)](#).

## FDP\_1

### Primitive: D Flip-Flop with Negative-Edge Clock and Asynchronous Preset

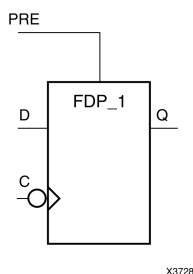

## Introduction

This design element is a single D-type flip-flop with data (D) and asynchronous preset (PRE) inputs and data output (Q). The asynchronous PRE, when High, overrides all other inputs and presets the Q output High. The data on the D input is loaded into the flip-flop when PRE is Low on the High-to-Low clock (C) transition.

This flip-flop is asynchronously preset, output High, when power is applied. For FPGA devices, power-on conditions are simulated when global set/reset (GSR) is active. GSR defaults to active-High but can be inverted by adding an inverter in front of the GSR input of the appropriate `STARTUP_architecture` symbol.

## Logic Table

Inputs			Outputs
PRE	C	D	Q
1	X	X	1
0	↓	D	D

## Design Entry Method

This design element is only for use in schematics.

## Available Attributes

Attribute	Data Type	Allowed Values	Default	Description
INIT	Binary	0, 1	1	Sets the initial value of Q output after configuration  For Spartan®-6, Xilinx recommends that the INIT value always matches the polarity of the set or reset. For this element, the INIT should be 1. If set to 0, additional asynchronous circuitry will be created to correctly model the behavior.

## For More Information

See the [Spartan-6 FPGA User Documentation \(User Guides and Data Sheets\)](#).

## FDPE

### Primitive: D Flip-Flop with Clock Enable and Asynchronous Preset

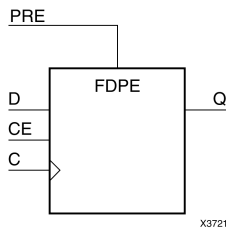

## Introduction

This design element is a single D-type flip-flop with data (D), clock enable (CE), and asynchronous preset (PRE) inputs and data output (Q). The asynchronous PRE, when High, overrides all other inputs and sets the (Q) output High. Data on the (D) input is loaded into the flip-flop when PRE is Low and CE is High on the Low-to-High clock (C) transition. When CE is Low, the clock transitions are ignored.

For FPGA devices, this flip-flop is asynchronously preset, output High, when power is applied. Power-on conditions are simulated when global set/reset (GSR) is active. GSR defaults to active-High but can be inverted by adding an inverter in front of the GSR input of the appropriate `STARTUP_architecture` symbol.

## Logic Table

Inputs				Outputs
PRE	CE	D	C	Q
1	X	X	X	1
0	0	X	X	No Change
0	1	D	↑	D

## Design Entry Method

This design element can be used in schematics.

## Available Attributes

Attribute	Data Type	Allowed Values	Default	Description
INIT	Binary	0, 1	1	Sets the initial value of Q output after configuration  For Spartan®-6, Xilinx recommends that the INIT value always matches the polarity of the set or reset. For this element, the INIT should be 1. If set to 0, additional asynchronous circuitry will be created to correctly model the behavior.

## For More Information

- See the [Spartan-6 FPGA Configurable Logic Block User Guide \(UG384\)](#).
- See the [Spartan-6 FPGA Data Sheet: DC and Switching Characteristics \(DS162\)](#).

## FDPE\_1

Primitive: D Flip-Flop with Negative-Edge Clock, Clock Enable, and Asynchronous Preset

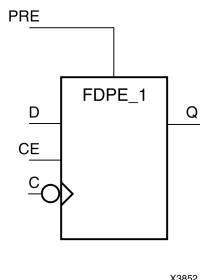

### Introduction

This design element is a single D-type flip-flop with data (D), clock enable (CE), and asynchronous preset (PRE) inputs and data output (Q). The asynchronous PRE, when High, overrides all other inputs and sets the (Q) output High. Data on the (D) input is loaded into the flip-flop when PRE is Low and CE is High on the High-to-Low clock (C) transition. When CE is Low, the clock transitions are ignored.

For FPGA devices, this flip-flop is asynchronously preset, output High, when power is applied. Power-on conditions are simulated when global set/reset (GSR) is active. GSR defaults to active-High but can be inverted by adding an inverter in front of the GSR input of the appropriate *STARTUP\_architecture* symbol.

### Logic Table

Inputs				Outputs
PRE	CE	D	C	Q
1	X	X	X	1
0	0	X	X	No Change
0	1	D	↓	D

### Design Entry Method

This design element is only for use in schematics.

### Available Attributes

Attribute	Data Type	Allowed Values	Default	Description
INIT	Binary	0, 1	1	Sets the initial value of Q output after configuration  For Spartan®-6, Xilinx recommends that the INIT value always matches the polarity of the set or reset. For this element, the INIT should be 1. If set to 0, additional asynchronous circuitry will be created to correctly model the behavior.

### For More Information

See the [Spartan-6 FPGA User Documentation \(User Guides and Data Sheets\)](#).



## FDR

### Primitive: D Flip-Flop with Synchronous Reset

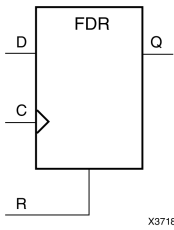

## Introduction

This design element is a single D-type flip-flop with data (D) and synchronous reset (R) inputs and data output (Q). The synchronous reset (R) input, when High, overrides all other inputs and resets the (Q) output Low on the Low-to-High clock (C) transition. The data on the (D) input is loaded into the flip-flop when R is Low during the Low-to-High clock transition.

This flip-flop is asynchronously cleared, outputs Low, when power is applied. For FPGA devices, power-on conditions are simulated when global set/reset (GSR) is active. GSR defaults to active-High but can be inverted by adding an inverter in front of the GSR input of the appropriate `STARTUP_architecture` symbol.

## Logic Table

Inputs			Outputs
R	D	C	Q
1	X	↑	0
0	D	↑	D

## Design Entry Method

This design element is only for use in schematics.

## Available Attributes

Attribute	Data Type	Allowed Values	Default	Description
INIT	Binary	0, 1	0	Sets the initial value of Q output after configuration

## For More Information

See the [Spartan-6 FPGA User Documentation \(User Guides and Data Sheets\)](#).

## FDR\_1

### Primitive: D Flip-Flop with Negative-Edge Clock and Synchronous Reset

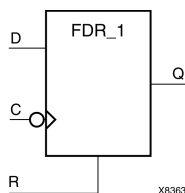

## Introduction

This design element is a single D-type flip-flop with data (D) and synchronous reset (R) inputs and data output (Q). The synchronous reset (R) input, when High, overrides all other inputs and resets the (Q) output Low on the High-to-Low clock (C) transition. The data on the (D) input is loaded into the flip-flop when R is Low during the High-to-Low clock transition.

This flip-flop is asynchronously cleared, outputs Low, when power is applied. For FPGA devices, power-on conditions are simulated when global set/reset (GSR) is active. GSR defaults to active-High but can be inverted by adding an inverter in front of the GSR input of the appropriate *STARTUP\_architecture* symbol.

## Logic Table

Inputs			Outputs
R	D	C	Q
1	X	↓	0
0	D	↓	D

## Design Entry Method

This design element is only for use in schematics.

## Available Attributes

Attribute	Data Type	Allowed Values	Default	Description
INIT	Binary	0, 1	0	Sets the initial value of Q output after configuration

## For More Information

See the [Spartan-6 FPGA User Documentation \(User Guides and Data Sheets\)](#).

## FDRE

### Primitive: D Flip-Flop with Clock Enable and Synchronous Reset

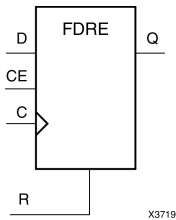

## Introduction

This design element is a single D-type flip-flop with data (D), clock enable (CE), and synchronous reset (R) inputs and data output (Q). The synchronous reset (R) input, when High, overrides all other inputs and resets the (Q) output Low on the Low-to-High clock (C) transition. The data on the (D) input is loaded into the flip-flop when R is Low and CE is High during the Low-to-High clock transition.

This flip-flop is asynchronously cleared, outputs Low, when power is applied. For FPGA devices, power-on conditions are simulated when global set/reset (GSR) is active. GSR defaults to active-High but can be inverted by adding an inverter in front of the GSR input of the appropriate `STARTUP_architecture` symbol.

## Logic Table

Inputs				Outputs
R	CE	D	C	Q
1	X	X	↑	0
0	0	X	X	No Change
0	1	D	↑	D

## Design Entry Method

This design element can be used in schematics.

## Available Attributes

Attribute	Data Type	Allowed Values	Default	Description
INIT	Binary	0, 1	0	<p>Sets the initial value of Q output after configuration</p> <p>For Spartan®-6, the INIT value should always match the polarity of the set or reset. For this element, the INIT should be 0. If set to 1, an asynchronous circuit must be created to exhibit this behavior, which Xilinx does not recommend.</p>

## For More Information

- See the [Spartan-6 FPGA Configurable Logic Block User Guide \(UG384\)](#).
- See the [Spartan-6 FPGA Data Sheet: DC and Switching Characteristics \(DS162\)](#).

## FDRE\_1

Primitive: D Flip-Flop with Negative-Clock Edge, Clock Enable, and Synchronous Reset

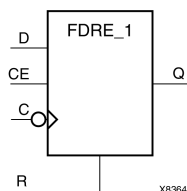

### Introduction

FDRE\_1 is a single D-type flip-flop with data (D), clock enable (CE), and synchronous reset (R) inputs and data output (Q). The synchronous reset (R) input, when High, overrides all other inputs and resets the (Q) output Low on the High-to-Low clock (C) transition. The data on the (D) input is loaded into the flip-flop when R is Low and CE is High during the High-to-Low clock transition.

This flip-flop is asynchronously cleared, outputs Low, when power is applied. For FPGA devices, power-on conditions are simulated when global set/reset (GSR) is active. GSR defaults to active-High but can be inverted by adding an inverter in front of the GSR input of the appropriate *STARTUP\_architecture* symbol.

### Logic Table

Inputs				Outputs
R	CE	D	C	Q
1	X	X	↓	0
0	0	X	X	No Change
0	1	D	↓	D

### Design Entry Method

This design element is only for use in schematics.

### Available Attributes

Attribute	Data Type	Allowed Values	Default	Description
INIT	Binary	0, 1	0	<p>Sets the initial value of Q output after configuration</p> <p>For Spartan®-6, the INIT value should always match the polarity of the set or reset. For this element, the INIT should be 0. If set to 1, an asynchronous circuit must be created to exhibit this behavior, which Xilinx does not recommend.</p>

### For More Information

See the [Spartan-6 FPGA User Documentation \(User Guides and Data Sheets\)](#).

# FDS

## Primitive: D Flip-Flop with Synchronous Set

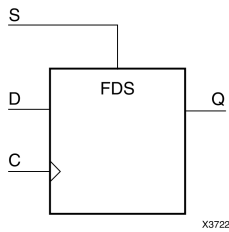

## Introduction

FDS is a single D-type flip-flop with data (D) and synchronous set (S) inputs and data output (Q). The synchronous set input, when High, sets the Q output High on the Low-to-High clock (C) transition. The data on the D input is loaded into the flip-flop when S is Low during the Low-to-High clock (C) transition.

For FPGA devices, this flip-flop is asynchronously preset, output High, when power is applied. Power-on conditions are simulated when global set/reset (GSR) is active. GSR defaults to active-High but can be inverted by adding an inverter in front of the GSR input of the appropriate `STARTUP_architecture` symbol.

## Logic Table

Inputs			Outputs
S	D	C	Q
1	X	↑	1
0	D	↑	D

## Design Entry Method

This design element is only for use in schematics.

## Available Attributes

Attribute	Data Type	Allowed Values	Default	Description
INIT	Binary	0, 1	1	Sets the initial value of Q output after configuration.

## For More Information

See the [Spartan-6 FPGA User Documentation \(User Guides and Data Sheets\)](#).

## FDS\_1

Primitive: D Flip-Flop with Negative-Edge Clock and Synchronous Set

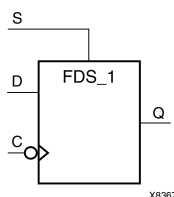

### Introduction

FDS is a single D-type flip-flop with data (D) and synchronous set (S) inputs and data output (Q). The synchronous set input, when High, sets the Q output High on the Low-to-High clock (C) transition. The data on the D input is loaded into the flip-flop when S is Low during the Low-to-High clock (C) transition.

This flip-flop is asynchronously preset, output High, when power is applied. For FPGA devices, power-on conditions are simulated when global set/reset (GSR) is active. GSR defaults to active-High but can be inverted by adding an inverter in front of the GSR input of the appropriate *STARTUP\_architecture* symbol.

### Logic Table

Inputs			Outputs
S	D	C	Q
1	X	↓	1
0	D	↓	D

### Design Entry Method

This design element is only for use in schematics.

### Available Attributes

Attribute	Data Type	Allowed Values	Default	Description
INIT	Binary	0, 1	1	Sets the initial value of Q output after configuration.

### For More Information

See the [Spartan-6 FPGA User Documentation \(User Guides and Data Sheets\)](#).

## FDSE

### Primitive: D Flip-Flop with Clock Enable and Synchronous Set

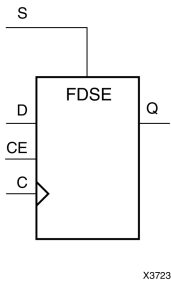

X3723

## Introduction

FDSE is a single D-type flip-flop with data (D), clock enable (CE), and synchronous set (S) inputs and data output (Q). The synchronous set (S) input, when High, overrides the clock enable (CE) input and sets the Q output High during the Low-to-High clock (C) transition. The data on the D input is loaded into the flip-flop when S is Low and CE is High during the Low-to-High clock (C) transition.

For FPGA devices, this flip-flop is asynchronously preset, output High, when power is applied. Power-on conditions are simulated when global set/reset (GSR) is active. GSR defaults to active-High but can be inverted by adding an inverter in front of the GSR input of the appropriate `STARTUP_architecture` symbol.

## Logic Table

Inputs				Outputs
S	CE	D	C	Q
1	X	X	↑	1
0	0	X	X	No Change
0	1	D	↑	D

## Design Entry Method

This design element can be used in schematics.

## Available Attributes

Attribute	Data Type	Allowed Values	Default	Description
INIT	Binary	0, 1	1	Sets the initial value of Q output after configuration  For Spartan®-6, Xilinx recommends that the INIT value always matches the polarity of the set or reset. For this element, the INIT should be 1. If set to 0, additional asynchronous circuitry will be created to correctly model the behavior.

## For More Information

- See the [Spartan-6 FPGA Configurable Logic Block User Guide \(UG384\)](#).
- See the [Spartan-6 FPGA Data Sheet: DC and Switching Characteristics \(DS162\)](#).

## FDSE\_1

Primitive: D Flip-Flop with Negative-Edge Clock, Clock Enable, and Synchronous Set

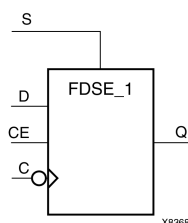

### Introduction

FDSE\_1 is a single D-type flip-flop with data (D), clock enable (CE), and synchronous set (S) inputs and data output (Q). The synchronous set (S) input, when High, overrides the clock enable (CE) input and sets the Q output High during the High-to-Low clock (C) transition. The data on the D input is loaded into the flip-flop when S is Low and CE is High during the High-to-Low clock (C) transition.

This flip-flop is asynchronously preset, output High, when power is applied. For FPGA devices, power-on conditions are simulated when global set/reset (GSR) is active. GSR defaults to active-High but can be inverted by adding an inverter in front of the GSR input of the appropriate *STARTUP\_architecture* symbol.

### Logic Table

Inputs				Outputs
S	CE	D	C	Q
1	X	X	↓	1
0	0	X	X	No Change
0	1	D	↓	D

### Design Entry Method

This design element is only for use in schematics.

### Available Attributes

Attribute	Data Type	Allowed Values	Default	Description
INIT	Binary	0, 1	1	Sets the initial value of Q output after configuration  For Spartan®-6, Xilinx recommends that the INIT value always matches the polarity of the set or reset. For this element, the INIT should be 1. If set to 0, additional asynchronous circuitry will be created to correctly model the behavior.

### For More Information

See the [Spartan-6 FPGA User Documentation \(User Guides and Data Sheets\)](#).



# FJKC

## Macro: J-K Flip-Flop with Asynchronous Clear

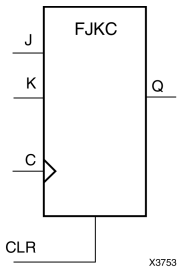

### Introduction

This design element is a single J-K-type flip-flop with J, K, and asynchronous clear (CLR) inputs and data output (Q). The asynchronous clear (CLR) input, when High, overrides all other inputs and resets the Q output Low. When CLR is Low, the output responds to the state of the J and K inputs, as shown in the following logic table, during the Low-to-High clock (C) transition.

This flip-flop is asynchronously cleared, outputs Low, when power is applied. For FPGA devices, power-on conditions are simulated when global set/reset (GSR) is active. GSR defaults to active-High but can be inverted by adding an inverter in front of the GSR input of the appropriate `STARTUP_architecture` symbol.

### Logic Table

Inputs				Outputs
CLR	J	K	C	Q
1	X	X	X	0
0	0	0	↑	No Change
0	0	1	↑	0
0	1	0	↑	1
0	1	1	↑	Toggle

### Design Entry Method

This design element is only for use in schematics.

### Available Attributes

Attribute	Data Type	Allowed Values	Default	Description
INIT	Binary	0, 1	0	<p>Sets the initial value of Q output after configuration</p> <p>For Spartan®-6, the INIT value should always match the polarity of the set or reset. For this element, the INIT should be 0. If set to 1, an asynchronous circuit must be created to exhibit this behavior, which Xilinx does not recommend.</p>

## For More Information

See the [Spartan-6 FPGA User Documentation \(User Guides and Data Sheets\)](#).

# FJKCE

## Macro: J-K Flip-Flop with Clock Enable and Asynchronous Clear

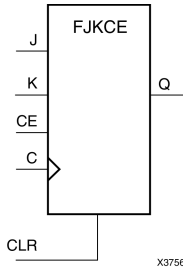

### Introduction

This design element is a single J-K-type flip-flop with J, K, clock enable (CE), and asynchronous clear (CLR) inputs and data output (Q). The asynchronous clear (CLR), when High, overrides all other inputs and resets the Q output Low. When CLR is Low and CE is High, Q responds to the state of the J and K inputs, as shown in the following logic table, during the Low-to-High clock transition. When CE is Low, the clock transitions are ignored.

This flip-flop is asynchronously cleared, outputs Low, when power is applied. For FPGA devices, power-on conditions are simulated when global set/reset (GSR) is active. GSR defaults to active-High but can be inverted by adding an inverter in front of the GSR input of the appropriate `STARTUP_architecture` symbol.

### Logic Table

Inputs					Outputs
CLR	CE	J	K	C	Q
1	X	X	X	X	0
0	0	X	X	X	No Change
0	1	0	0	X	No Change
0	1	0	1	↑	0
0	1	1	0	↑	1
0	1	1	1	↑	Toggle

### Design Entry Method

This design element is only for use in schematics.

### Available Attributes

Attribute	Data Type	Allowed Values	Default	Description
INIT	Binary	0, 1	0	<p>Sets the initial value of Q output after configuration</p> <p>For Spartan®-6, the INIT value should always match the polarity of the set or reset. For this element, the INIT should be 0. If set to 1, an asynchronous circuit must be created to exhibit this behavior, which Xilinx does not recommend.</p>

## For More Information

See the [Spartan-6 FPGA User Documentation \(User Guides and Data Sheets\)](#).

# FJKP

## Macro: J-K Flip-Flop with Asynchronous Preset

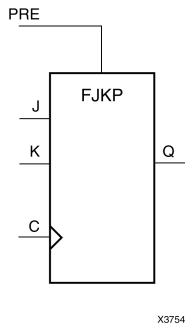

### Introduction

This design element is a single J-K-type flip-flop with J, K, and asynchronous preset (PRE) inputs and data output (Q). The asynchronous preset (PRE) input, when High, overrides all other inputs and sets the (Q) output High. When (PRE) is Low, the (Q) output responds to the state of the J and K inputs, as shown in the following logic table, during the Low-to-High clock transition.

For FPGA devices, this flip-flop is asynchronously preset, output High, when power is applied. Power-on conditions are simulated when global set/reset (GSR) is active. GSR defaults to active-High but can be inverted by adding an inverter in front of the GSR input of the appropriate *STARTUP\_architecture* symbol.

### Logic Table

Inputs				Outputs
PRE	J	K	C	Q
1	X	X	X	1
0	0	0	X	No Change
0	0	1	↑	0
0	1	0	↑	1
0	1	1	↑	Toggle

### Design Entry Method

This design element is only for use in schematics.

### Available Attributes

Attribute	Data Type	Allowed Values	Default	Description
INIT	Binary	0, 1	1	Sets the initial value of Q output after configuration  For Spartan®-6, Xilinx recommends that the INIT value always matches the polarity of the set or reset. For this element, the INIT should be 1. If set to 0, additional asynchronous circuitry will be created to correctly model the behavior.

## For More Information

See the [Spartan-6 FPGA User Documentation \(User Guides and Data Sheets\)](#).

# FJKPE

## Macro: J-K Flip-Flop with Clock Enable and Asynchronous Preset

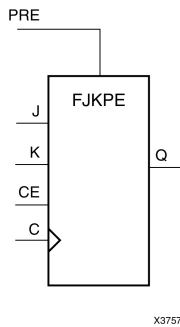

### Introduction

This design element is a single J-K-type flip-flop with J, K, clock enable (CE), and asynchronous preset (PRE) inputs and data output (Q). The asynchronous preset (PRE), when High, overrides all other inputs and sets the (Q) output High. When (PRE) is Low and (CE) is High, the (Q) output responds to the state of the J and K inputs, as shown in the logic table, during the Low-to-High clock (C) transition. When (CE) is Low, clock transitions are ignored.

For FPGA devices, this flip-flop is asynchronously preset, output High, when power is applied. Power-on conditions are simulated when global set/reset (GSR) is active. GSR defaults to active-High but can be inverted by adding an inverter in front of the GSR input of the appropriate STARTUP\_architecture symbol.

### Logic Table

Inputs					Outputs
PRE	CE	J	K	C	Q
1	X	X	X	X	1
0	0	X	X	X	No Change
0	1	0	0	X	No Change
0	1	0	1	↑	0
0	1	1	0	↑	1
0	1	1	1	↑	Toggle

### Design Entry Method

This design element is only for use in schematics.

## Available Attributes

Attribute	Data Type	Allowed Values	Default	Description
INIT	Binary	0, 1	1	Sets the initial value of Q output after configuration  For Spartan®-6, Xilinx recommends that the INIT value always matches the polarity of the set or reset. For this element, the INIT should be 1. If set to 0, additional asynchronous circuitry will be created to correctly model the behavior.

## For More Information

See the [Spartan-6 FPGA User Documentation \(User Guides and Data Sheets\)](#).



# FTC

## Macro: Toggle Flip-Flop with Asynchronous Clear

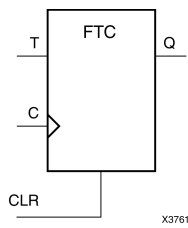

## Introduction

This design element is a synchronous, resettable toggle flip-flop. The asynchronous clear (CLR) input, when High, overrides all other inputs and resets the data output (Q) Low. The (Q) output toggles, or changes state, when the toggle enable (T) input is High and (CLR) is Low during the Low-to-High clock transition.

This flip-flop is asynchronously cleared, outputs Low, when power is applied. For FPGA devices, power-on conditions are simulated when global set/reset (GSR) is active. GSR defaults to active-High but can be inverted by adding an inverter in front of the GSR input of the appropriate `STARTUP_architecture` symbol.

## Logic Table

Inputs			Outputs
CLR	T	C	Q
1	X	X	0
0	0	X	No Change
0	1	↑	Toggle

## Design Entry Method

You can instantiate this element when targeting a CPLD, but not when you are targeting an FPGA.

## Available Attributes

Attribute	Data Type	Allowed Values	Default	Description
INIT	Binary	0, 1	0	<p>Sets the initial value of Q output after configuration</p> <p>For Spartan®-6, the INIT value should always match the polarity of the set or reset. For this element, the INIT should be 0. If set to 1, an asynchronous circuit must be created to exhibit this behavior, which Xilinx does not recommend.</p>

## For More Information

See the [Spartan-6 FPGA User Documentation \(User Guides and Data Sheets\)](#).

## FTCE

### Macro: Toggle Flip-Flop with Clock Enable and Asynchronous Clear

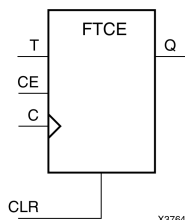

## Introduction

This design element is a toggle flip-flop with toggle and clock enable and asynchronous clear. When the asynchronous clear (CLR) input is High, all other inputs are ignored and the data output (Q) is reset Low. When CLR is Low and toggle enable (T) and clock enable (CE) are High, Q output toggles, or changes state, during the Low-to-High clock (C) transition. When CE is Low, clock transitions are ignored.

This flip-flop is asynchronously cleared, outputs Low, when power is applied. For FPGA devices, power-on conditions are simulated when global set/reset (GSR) is active. GSR defaults to active-High but can be inverted by adding an inverter in front of the GSR input of the appropriate `STARTUP_architecture` symbol.

## Logic Table

Inputs				Outputs
CLR	CE	T	C	Q
1	X	X	X	0
0	0	X	X	No Change
0	1	0	X	No Change
0	1	1	↑	Toggle

## Design Entry Method

This design element is only for use in schematics.

## Available Attributes

Attribute	Data Type	Allowed Values	Default	Description
INIT	Binary	0, 1	0	<p>Sets the initial value of Q output after configuration</p> <p>For Spartan®-6, the INIT value should always match the polarity of the set or reset. For this element, the INIT should be 0. If set to 1, an asynchronous circuit must be created to exhibit this behavior, which Xilinx does not recommend.</p>

## For More Information

See the [Spartan-6 FPGA User Documentation \(User Guides and Data Sheets\)](#).

# FTCLE

## Macro: Toggle/Loadable Flip-Flop with Clock Enable and Asynchronous Clear

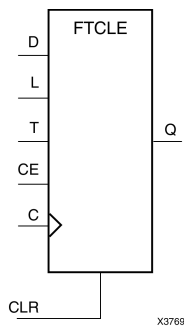

### Introduction

This design element is a toggle/loadable flip-flop with toggle and clock enable and asynchronous clear. When the asynchronous clear input (CLR) is High, all other inputs are ignored and output Q is reset Low. When load enable input (L) is High and CLR is Low, clock enable (CE) is overridden and the data on data input (D) is loaded into the flip-flop during the Low-to-High clock (C) transition. When toggle enable (T) and CE are High and L and CLR are Low, output Q toggles, or changes state, during the Low- to-High clock transition. When CE is Low, clock transitions are ignored.

This flip-flop is asynchronously cleared, outputs Low, when power is applied. For FPGA devices, power-on conditions are simulated when global set/reset (GSR) is active. GSR defaults to active-High but can be inverted by adding an inverter in front of the GSR input of the appropriate STARTUP\_architecture symbol.

### Logic Table

Inputs						Outputs
CLR	L	CE	T	D	C	Q
1	X	X	X	X	X	0
0	1	X	X	D	↑	D
0	0	0	X	X	X	No Change
0	0	1	0	X	X	No Change
0	0	1	1	X	↑	Toggle

### Design Entry Method

This design element is only for use in schematics.

## Available Attributes

Attribute	Data Type	Allowed Values	Default	Description
INIT	Binary	0, 1	0	<p>Sets the initial value of Q output after configuration</p> <p>For Spartan®-6, the INIT value should always match the polarity of the set or reset. For this element, the INIT should be 0. If set to 1, an asynchronous circuit must be created to exhibit this behavior, which Xilinx does not recommend.</p>

## For More Information

See the [Spartan-6 FPGA User Documentation \(User Guides and Data Sheets\)](#).

# FTCLEX

## Macro: Toggle/Loadable Flip-Flop with Clock Enable and Asynchronous Clear

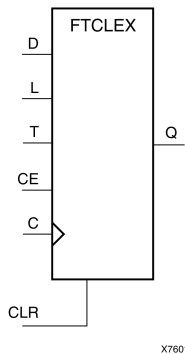

### Introduction

This design element is a toggle/loadable flip-flop with toggle and clock enable and asynchronous clear. When the asynchronous clear input (CLR) is High, all other inputs are ignored and output Q is reset Low. When load enable input (L) is High, CLR is Low, and CE is High, the data on data input (D) is loaded into the flip-flop during the Low-to-High clock (C) transition. When toggle enable (T) and CE are High and L and CLR are Low, output Q toggles, or changes state, during the Low- to-High clock transition. When CE is Low, clock transitions are ignored.

This flip-flop is asynchronously cleared, outputs Low, when power is applied. For FPGA devices, power-on conditions are simulated when global set/reset (GSR) is active. GSR defaults to active-High but can be inverted by adding an inverter in front of the GSR input of the appropriate STARTUP\_architecture symbol.

### Logic Table

Inputs						Outputs
CLR	L	CE	T	D	C	Q
1	X	X	X	X	X	0
0	1	X	X	D	↑	D
0	0	0	X	X	X	No Change
0	0	1	0	X	X	No Change
0	0	1	1	X	↑	Toggle

### Design Entry Method

This design element is only for use in schematics.

## Available Attributes

Attribute	Data Type	Allowed Values	Default	Description
INIT	Binary	0, 1	0	<p>Sets the initial value of Q output after configuration</p> <p>For Spartan®-6, the INIT value should always match the polarity of the set or reset. For this element, the INIT should be 0. If set to 1, an asynchronous circuit must be created to exhibit this behavior, which Xilinx does not recommend.</p>

## For More Information

See the [Spartan-6 FPGA User Documentation \(User Guides and Data Sheets\)](#).

# FTP

## Macro: Toggle Flip-Flop with Asynchronous Preset

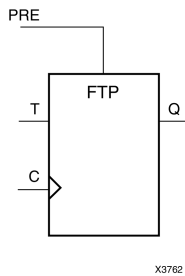

## Introduction

This design element is a toggle flip-flop with toggle enable and asynchronous preset. When the asynchronous preset (PRE) input is High, all other inputs are ignored and output (Q) is set High. When toggle-enable input (T) is High and (PRE) is Low, output (Q) toggles, or changes state, during the Low-to-High clock (C) transition.

For FPGA devices, this flip-flop is asynchronously preset, output High, when power is applied. Power-on conditions are simulated when global set/reset (GSR) is active. GSR defaults to active-High but can be inverted by adding an inverter in front of the GSR input of the appropriate `STARTUP_architecture` symbol.

## Logic Table

Inputs			Outputs
PRE	T	C	Q
1	X	X	1
0	0	X	No Change
0	1	↑	Toggle

## Design Entry Method

This design element is only for use in schematics.

## Available Attributes

Attribute	Data Type	Allowed Values	Default	Description
INIT	Binary	0, 1	1	Sets the initial value of Q output after configuration  For Spartan®-6, Xilinx recommends that the INIT value always matches the polarity of the set or reset. For this element, the INIT should be 1. If set to 0, additional asynchronous circuitry will be created to correctly model the behavior.

## For More Information

See the [Spartan-6 FPGA User Documentation \(User Guides and Data Sheets\)](#).

## FTPE

### Macro: Toggle Flip-Flop with Clock Enable and Asynchronous Preset

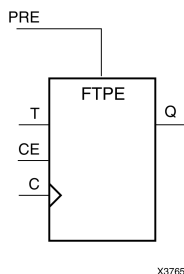

## Introduction

This design element is a toggle flip-flop with toggle and clock enable and asynchronous preset. When the asynchronous preset (PRE) input is High, all other inputs are ignored and output (Q) is set High. When the toggle enable input (T) is High, clock enable (CE) is High, and (PRE) is Low, output (Q) toggles, or changes state, during the Low-to-High clock transition. When (CE) is Low, clock transitions are ignored.

For FPGA devices, this flip-flop is asynchronously preset, output High, when power is applied. Power-on conditions are simulated when global set/reset (GSR) is active. GSR defaults to active-High but can be inverted by adding an inverter in front of the GSR input of the appropriate *STARTUP\_architecture* symbol.

## Logic Table

Inputs				Outputs
PRE	CE	T	C	Q
1	X	X	X	1
0	0	X	X	No Change
0	1	0	X	No Change
0	1	1	↑	Toggle

## Design Entry Method

This design element is only for use in schematics.

## Available Attributes

Attribute	Data Type	Allowed Values	Default	Description
INIT	Binary	0, 1	1	Sets the initial value of Q output after configuration  For Spartan®-6, Xilinx recommends that the INIT value always matches the polarity of the set or reset. For this element, the INIT should be 1. If set to 0, additional asynchronous circuitry will be created to correctly model the behavior.

## For More Information

See the [Spartan-6 FPGA User Documentation \(User Guides and Data Sheets\)](#).



# FTPLE

## Macro: Toggle/Loadable Flip-Flop with Clock Enable and Asynchronous Preset

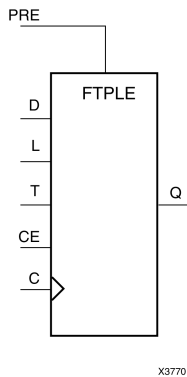

### Introduction

This design element is a toggle/loadable flip-flop with toggle and clock enable and asynchronous preset. When the asynchronous preset input (PRE) is High, all other inputs are ignored and output (Q) is set High. When the load enable input (L) is High and (PRE) is Low, the clock enable (CE) is overridden and the data (D) is loaded into the flip-flop during the Low-to-High clock transition. When L and PRE are Low and toggle-enable input (T) and (CE) are High, output (Q) toggles, or changes state, during the Low-to-High clock transition. When (CE) is Low, clock transitions are ignored.

For FPGA devices, this flip-flop is asynchronously preset, output High, when power is applied. Power-on conditions are simulated when global set/reset (GSR) is active. GSR defaults to active-High but can be inverted by adding an inverter in front of the GSR input of the appropriate STARTUP\_architecture symbol.

### Logic Table

Inputs						Outputs
PRE	L	CE	T	D	C	Q
1	X	X	X	X	X	1
0	1	X	X	D	↑	D
0	0	0	X	X	X	No Change
0	0	1	0	X	X	No Change
0	0	1	1	X	↑	Toggle

### Design Entry Method

This design element is only for use in schematics.

## Available Attributes

Attribute	Data Type	Allowed Values	Default	Description
INIT	Binary	0, 1	1	Sets the initial value of Q output after configuration  For Spartan®-6, Xilinx recommends that the INIT value always matches the polarity of the set or reset. For this element, the INIT should be 1. If set to 0, additional asynchronous circuitry will be created to correctly model the behavior.

## For More Information

See the [Spartan-6 FPGA User Documentation \(User Guides and Data Sheets\)](#).

# GND

## Primitive: Ground-Connection Signal Tag

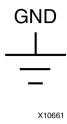

## Introduction

The GND signal tag, or parameter, forces a net or input function to a Low logic level. A net tied to GND cannot have any other source.

When the logic-trimming software or fitter encounters a net or input function tied to GND, it removes any logic that is disabled by the GND signal. The GND signal is only implemented when the disabled logic cannot be removed.

## Design Entry Method

This design element is only for use in schematics.

## For More Information

See the [Spartan-6 FPGA User Documentation \(User Guides and Data Sheets\)](#).

# GTPA1\_DUAL

Primitive: Dual Gigabit Transceiver

GTPA1\_DUAL

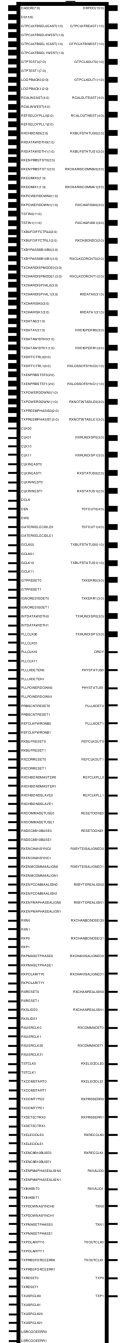

X11154

## Introduction

This design element represents the Spartan®-6 FPGA RocketIO™ GTP transceiver, a power-efficient and highly configurable transceiver. Refer to *Spartan-6 FPGA RocketIO GTP Transceiver User Guide* for detailed information regarding this component. The Spartan-6 FPGA RocketIO GTX Transceiver Wizard is the preferred tool to generate a wrapper to instantiate a GTPA1\_DUAL primitive. The Wizard can be found in the Xilinx® CORE Generator™ tool.

## Design Entry Method

To instantiate this component, use the Spartan-6 FPGA RocketIO GTX Transceiver Wizard or an associated core containing the component. Xilinx does not recommend direct instantiation of this component.

This design element can be used in schematics.

## For More Information

- See the [Spartan-6 FPGA RocketIO GTP Transceivers User Guide \(UG386\)](#).
- See the [Spartan-6 FPGA Data Sheet: DC and Switching Characteristics \(DS162\)](#).

## IBUF

### Primitive: Input Buffer

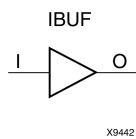

## Introduction

This design element is automatically inserted (inferred) by the synthesis tool to any signal directly connected to a top-level input or in-out port of the design. You should generally let the synthesis tool infer this buffer. However, it can be instantiated into the design if required. In order to do so, connect the input port (I) directly to the associated top-level input or in-out port, and connect the output port (O) to the logic sourced by that port. Modify any necessary generic maps (VHDL) or named parameter value assignment (Verilog) in order to change the default behavior of the component.

## Port Descriptions

Port	Direction	Width	Function
O	Output	1	Buffer output
I	Input	1	Buffer input

## Design Entry Method

This design element can be used in schematics.

## Available Attributes

Attribute	Data Type	Allowed Values	Default	Description
IOSTANDARD	String	See Data Sheet.	"DEFAULT"	Assigns an I/O standard to the element.

## For More Information

- See the [Spartan-6 FPGA SelectIO Resources User Guide \(UG381\)](#).
- See the [Spartan-6 FPGA Data Sheet: DC and Switching Characteristics \(DS162\)](#).

## IBUF16

### Macro: 16-Bit Input Buffer

IBUF16

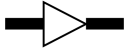

X3815

## Introduction

Input Buffers isolate the internal circuit from the signals coming into the chip. This design element is contained in input/output blocks (IOBs) and allows the specification of the particular I/O Standard to configure the I/O. In general, an this element should be used for all single-ended data input or bidirectional pins.

## Design Entry Method

This design element can be used in schematics.

## Available Attributes

Attribute	Data Type	Allowed Values	Default	Description
IOSTANDARD	String	See Data Sheet.	"DEFAULT"	Assigns an I/O standard to the element.

## For More Information

See the [Spartan-6 FPGA User Documentation \(User Guides and Data Sheets\)](#).

## IBUF4

### Macro: 4-Bit Input Buffer

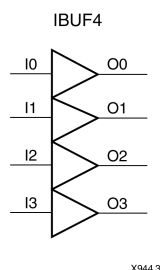

## Introduction

Input Buffers isolate the internal circuit from the signals coming into the chip. This design element is contained in input/output blocks (IOBs) and allows the specification of the particular I/O Standard to configure the I/O. In general, an this element should be used for all single-ended data input or bidirectional pins.

## Design Entry Method

This design element can be used in schematics.

## Available Attributes

Attribute	Data Type	Allowed Values	Default	Description
IOSTANDARD	String	See Data Sheet.	"DEFAULT"	Assigns an I/O standard to the element.

## For More Information

See the [Spartan-6 FPGA User Documentation \(User Guides and Data Sheets\)](#).



## IBUF8

### Macro: 8-Bit Input Buffer

IBUF8

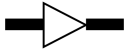

X3803

## Introduction

Input Buffers isolate the internal circuit from the signals coming into the chip. This design element is contained in input/output blocks (IOBs) and allows the specification of the particular I/O Standard to configure the I/O. In general, an this element should be used for all single-ended data input or bidirectional pins.

## Design Entry Method

This design element can be used in schematics.

## Available Attributes

Attribute	Data Type	Allowed Values	Default	Description
IOSTANDARD	String	See Data Sheet.	"DEFAULT"	Assigns an I/O standard to the element.

## For More Information

See the [Spartan-6 FPGA User Documentation \(User Guides and Data Sheets\)](#).

## IBUFDS

### Primitive: Differential Signaling Input Buffer

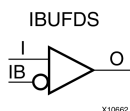

## Introduction

This design element is an input buffer that supports low-voltage, differential signaling. In IBUFDS, a design level interface signal is represented as two distinct ports (I and IB), one deemed the "master" and the other the "slave." The master and the slave are opposite phases of the same logical signal (for example, MYNET\_P and MYNET\_N). Optionally, a programmable differential termination feature is available to help improve signal integrity and reduce external components.

## Logic Table

Inputs		Outputs
I	IB	O
0	0	No Change
0	1	0
1	0	1
1	1	No Change

## Port Descriptions

Port	Direction	Width	Function
I	Input	1	Diff_p Buffer Input
IB	Input	1	Diff_n Buffer Input
O	Output	1	Buffer Output

## Design Entry Method

This design element can be used in schematics.

Put all I/O components on the top-level of the design to help facilitate hierarchical design methods. Connect the I port directly to the top-level "master" input port of the design, the IB port to the top-level "slave" input port, and the O port to the logic in which this input is to source. Specify the desired generic/default values in order to configure the proper behavior of the buffer.

## Available Attributes

Attribute	Data Type	Allowed Values	Default	Description
DIFF_TERM	Boolean	TRUE or FALSE	FALSE	Enables the built-in differential termination resistor.
IOSTANDARD	String	See Data Sheet.	"DEFAULT"	Assigns an I/O standard to the element.

## For More Information

- See the [Spartan-6 FPGA SelectIO Resources User Guide \(UG381\)](#).
- See the [Spartan-6 FPGA Data Sheet: DC and Switching Characteristics \(DS162\)](#).

## IBUFDS\_DIFF\_OUT

Primitive: Signaling Input Buffer with Differential Output

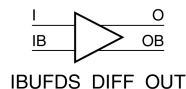

X10107

### Introduction

This design element is an input buffer that supports differential signaling. In IBUFDS\_DIFF\_OUT, a design level interface signal is represented as two distinct ports (I and IB), one deemed the "master" and the other the "slave." The master and the slave are opposite phases of the same logical signal (for example, MYNET\_P and MYNET\_N). The IBUFDS\_DIFF\_OUT differs from the IBUFDS in that it allows internal access to both phases of the differential signal. Optionally, a programmable differential termination feature is available to help improve signal integrity and reduce external components.

### Logic Table

Inputs		Outputs	
I	IB	O	OB
0	0	No Change	No Change
0	1	0	1
1	0	1	0
1	1	No Change	No Change

### Design Entry Method

This design element can be used in schematics.

It is suggested to put all I/O components on the top-level of the design to help facilitate hierarchical design methods. Connect the I port directly to the top-level "master" input port of the design, the IB port to the top-level "slave" input port, and the O and OB ports to the logic in which this input is to source. Specify the desired generic/parameter values in order to configure the proper behavior of the buffer.

### Available Attributes

Attribute	Data Type	Allowed Values	Default	Description
IOSTANDARD	String	See Data Sheet.	"DEFAULT"	Assigns an I/O standard to the element.

### For More Information

- See the [Spartan-6 FPGA Clocking Resources User Guide \(UG382\)](#).
- See the [Spartan-6 FPGA SelectIO Resources User Guide \(UG381\)](#).
- See the [Spartan-6 FPGA Data Sheet: DC and Switching Characteristics \(DS162\)](#).

# IBUFDS\_DLY\_ADJ

## Primitive: Dynamically Adjustable Differential Input Delay Buffer

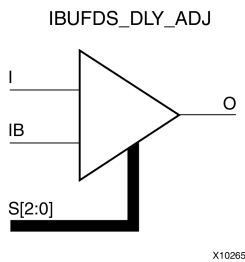

### Introduction

This design element is a differential input buffer with an adjustable delay element allowing dynamic delay adjustment (delay tuning) of an input signal into the FPGA. This is particularly useful for data aligning and capturing of high-speed input signals into the FPGA over process, voltage, and temperature variations. This component consists of a 3-bit select bus, which allows 8 unique values of delay to be added to the incoming signal. Additionally, the component can be programmed with a delay offset to delay adjustment within either the lower 8 or upper 8 of the 16 contiguous delay values.

### Port Descriptions

Port	Direction	Width	Function
O	Output	1	Delayed output from the buffer
I	Input	1	Differential input data (positive)
IB	Input	1	Differential input data (negative)
S	Input	3	Dynamic delay adjustment select lines

### Design Entry Method

This design element can be used in schematics.

### Available Attributes

Attribute	Data Type	Allowed Values	Default	Description
DELAY_OFFSET	String	"OFF", "ON"	"OFF"	When set to OFF, the IBUFDS_DLY_ADJ operates at the lower range of delay values. This should be used when a smaller amount of additional delay is needed. When set to "ON", the component operates at the upper (longer) range of delay values. This should be used when a larger amount of additional delay is needed.
IOSTANDARD	String	See Data Sheet	"DEFAULT"	Assigns an I/O standard to the element.

### For More Information

See the [Spartan-6 FPGA User Documentation \(User Guides and Data Sheets\)](#).

## IBUFG

Primitive: Dedicated Input Clock Buffer

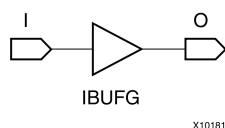

### Introduction

The IBUFG is a dedicated input to the device which should be used to connect incoming clocks to the FPGA's global clock routing resources. The IBUFG provides dedicated connections to the DCM, PLL, or BUFG resources, providing the minimum amount of clock delay and jitter to the device. The IBUFG input can only be driven by the global clock (GC) pins.

### Port Descriptions

Port	Direction	Width	Function
O	Output	1	Clock Buffer output
I	Input	1	Clock Buffer input

### Design Entry Method

This design element can be used in schematics.

### Available Attributes

Attribute	Data Type	Allowed Values	Default	Description
IOSTANDARD	String	See Data Sheet	"DEFAULT"	Assigns an I/O standard to the element.

### For More Information

- See the [Spartan-6 FPGA SelectIO Resources User Guide \(UG381\)](#).
- See the [Spartan-6 FPGA Data Sheet: DC and Switching Characteristics \(DS162\)](#).

## IBUFGDS

### Primitive: Differential Signaling Dedicated Input Clock Buffer and Optional Delay

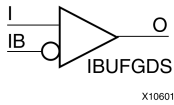

## Introduction

This design element is a dedicated differential signaling input buffer for connection to the clock buffer (BUFG) or MMCM. In IBUFGDS, a design-level interface signal is represented as two distinct ports (I and IB), one deemed the "master" and the other the "slave." The master and the slave are opposite phases of the same logical signal (for example, MYNET\_P and MYNET\_N). Optionally, a programmable differential termination feature is available to help improve signal integrity and reduce external components. Also available is a programmable delay to assist in the capturing of incoming data to the device.

## Logic Table

Inputs		Outputs
I	IB	O
0	0	No Change
0	1	0
1	0	1
1	1	No Change

## Port Descriptions

Port	Direction	Width	Function
O	Output	1	Clock Buffer output
IB	Input	1	Diff_n Clock Buffer Input
I	Input	1	Diff_p Clock Buffer Input

## Design Entry Method

This design element can be used in schematics.

Put all I/O components on the top-level of the design to help facilitate hierarchical design methods. Connect the I port directly to the top-level "master" input port of the design, the IB port to the top-level "slave" input port and the O port to an MMCM, BUFG or logic in which this input is to source. Some synthesis tools infer the BUFG automatically if necessary, when connecting an IBUFG to the clock resources of the FPGA. Specify the desired generic/defparam values in order to configure the proper behavior of the buffer.

## Available Attributes

Attribute	Data Type	Allowed Values	Default	Description
IOSTANDARD	String	See Data Sheet	"DEFAULT"	Assigns an I/O standard to the element.

## For More Information

- See the [Spartan-6 FPGA SelectIO Resources User Guide \(UG381\)](#).
- See the [Spartan-6 FPGA Data Sheet: DC and Switching Characteristics \(DS162\)](#).



## IBUFGDS\_DIFF\_OUT

Primitive: Differential Signaling Input Buffer with Differential Output

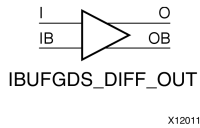

### Introduction

This design element is an input buffer that supports differential signaling. In IBUFGDS\_DIFF\_OUT, a design level interface signal is represented as two distinct ports (I and IB), one deemed the "master" and the other the "slave." The master and the slave are opposite phases of the same logical signal (for example, MYNET\_P and MYNET\_N). The IBUFGDS\_DIFF\_OUT differs from the IBUFGDS in that it allows internal access to both phases of the differential signal. Optionally, a programmable differential termination feature is available to help improve signal integrity and reduce external components.

### Logic Table

Inputs		Outputs	
I	IB	O	OB
0	0	No Change	No Change
0	1	0	1
1	0	1	0
1	1	No Change	No Change

### Port Descriptions

Port	Direction	Width	Function
I	Input	1	Diff_p Buffer Input (connect to top-level port in the design).
IB	Input	1	Diff_n Buffer Input (connect to top-level port in the design).
O	Output	1	Diff_p Buffer Output.
OB	Output	1	Diff_n Buffer Output.

### Design Entry Method

This design element can be used in schematics.

It is suggested to put all I/O components on the top-level of the design to help facilitate hierarchical design methods. Connect the I port directly to the top-level "master" input port of the design, the IB port to the top-level "slave" input port, and the O and OB ports to the logic in which this input is to source. Specify the desired generic/parameter values in order to configure the proper behavior of the buffer.

### Available Attributes

Attribute	Data Type	Allowed Values	Default	Description
IOSTANDARD	String	See Data Sheet	"DEFAULT"	Assigns an I/O standard to the element.
DIFF_TERM	Boolean	TRUE, FALSE	FALSE	Specifies the use of the internal differential termination resistance.

## For More Information

- See the [Spartan-6 FPGA SelectIO Resources User Guide \(UG381\)](#).
- See the [Spartan-6 FPGA Data Sheet: DC and Switching Characteristics \(DS162\)](#).

# ICAP\_SPARTAN6

## Primitive: Internal Configuration Access Port

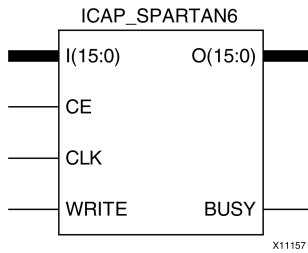

## Introduction

This design element gives you access to the configuration functions of the FPGA from the FPGA fabric. Using this component, commands and data can be written to and read from the configuration logic of the FPGA array. Since the improper use of this function can have a negative effect on the functionality and reliability of the FPGA, you should not use this element unless you are very familiar with its capabilities.

## Port Descriptions

Port	Direction	Width	Function
BUSY	Output	1	Busy/Ready output.
CE	Input	1	Active-Low ICAP Enable input.
CLK	Input	1	Clock input.
I[15:0]	Input	16	Configuration data input bus.
O[15:0]	Output	16	Configuration data output bus.
WRITE	Input	1	Read/Write control input.

## Design Entry Method

This design element can be used in schematics.

## Available Attributes

Attribute	Data Type	Allowed Values	Default	Description
DEVICE_ID	Hexadecimal	32'h04000093, 32'h0400E093, 32'h0401D093, 32'h0402E093, 32'h0403D093, 32'h04001093, 32'h04002093, 32'h04004093, 32'h04008093, 32'h04011093, 32'h04024093, 32'h04028093, 32'h04031093	32'h04000093	Specifies the pre-programmed Device ID value to be used for simulation purposes.
SIM_CFG_FILE_NAME	String	String representing file name and location	None	Specifies the Raw Bitstream (RBT) file to be parsed by the simulation model.

## For More Information

- See the [Spartan-6 FPGA Configuration User Guide \(UG380\)](#).
- See the [Spartan-6 FPGA Data Sheet: DC and Switching Characteristics \(DS162\)](#).

## IDDR2

Primitive: Double Data Rate Input D Flip-Flop with Optional Data Alignment, Clock Enable and Programmable Synchronous or Asynchronous Set/Reset

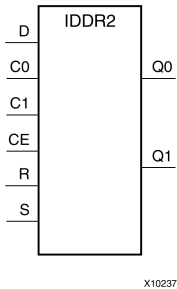

### Introduction

This design element is a dedicated input register designed to receive external dual data rate (DDR) signals into Xilinx® FPGAs. The IDDR2 requires two clocks to be connected to the component, C0 and C1, so that data is captured at the positive edge of both C0 and C1 clocks. The IDDR2 features an active high clock enable port, CE, which be used to suspend the operation of the registers, and both set and reset ports that be configured to be synchronous or asynchronous to the respective clocks. The IDDR2 has an optional alignment feature that allows both output data ports to the component to be aligned to a single clock.

### Logic Table

Input						Output	
S	R	CE	D	C0	C1	Q0	Q1
1	x	x	x	x	x	INIT_Q0	INIT_Q1
0	1	x	x	x	x	not INIT_Q0	not INIT_Q1
0	0	0	x	x	x	No Change	No Change
0	0	1	D	↑	x	D	No Change
0	0	1	D	x	↑	No Change	D

Set/Reset can be synchronous via SRTYPE value

### Design Entry Method

This design element can be used in schematics.

All inputs and outputs of this component should either be connected or properly tied off.

## Available Attributes

Attribute	Data Type	Allowed Values	Default	Description
DDR_ALIGNMENT	String	"NONE", "C0", "C1"	"NONE"	Sets the output alignment more for the DDR register <ul style="list-style-type: none"> <li>NONE - Makes the data available on the Q0 and Q1 outputs shortly after the corresponding C0 or C1 positive clock edge.</li> <li>C0 - Makes the data on both Q0 and Q1 align to the positive edge of the C0 clock.</li> <li>C1 - Makes the data on both Q0 and Q1 align to the positive edge of the C1 clock.</li> </ul>
INIT_Q0	Integer	0, 1	0	Sets initial state of the Q0 output to 0 or 1.
INIT_Q1	Integer	0, 1	0	Sets initial state of the Q1 output to 0 or 1.
SRTYPE	String	"SYNC", "ASYNC"	"SYNC"	Specifies "SYNC" or "ASYNC" set/reset.

## For More Information

- See the [Spartan-6 FPGA Configurable Logic Block User Guide \(UG384\)](#).
- See the [Spartan-6 FPGA Data Sheet: DC and Switching Characteristics \(DS162\)](#).

## IFD

### Macro: Input D Flip-Flop

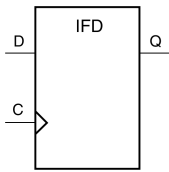

X3776

## Introduction

This D-type flip-flop is contained in an input/output block (IOB). The input (D) of the flip-flop is connected to an IPAD or an IOPAD (without using an IBUF). The (D) input provides data input for the flip-flop, which synchronizes data entering the chip. The data on input (D) is loaded into the flip-flop during the Low-to-High clock (C) transition and appears at the output (Q). The clock input can be driven by internal logic or through another external pin.

This flip-flop is asynchronously cleared, outputs Low, when power is applied. For FPGA devices, power-on conditions are simulated when global set/reset (GSR) is active. GSR defaults to active-High but can be inverted by adding an inverter in front of the GSR input of the appropriate `STARTUP_architecture` symbol.

## Logic Table

Inputs		Outputs
D	C	Q
D	↑	D

## Design Entry Method

This design element is only for use in schematics.

## For More Information

See the [Spartan-6 FPGA User Documentation \(User Guides and Data Sheets\)](#).

## IFD\_1

### Macro: Input D Flip-Flop with Inverted Clock (Asynchronous Preset)

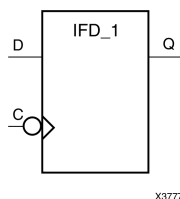

## Introduction

This design element is a D-type flip flop which is contained in an input/output block (IOB). The input (D) of the flip-flop is connected to an IPAD or an IOPAD. The D input also provides data input for the flip-flop, which synchronizes data entering the chip. The D input data is loaded into the flip-flop during the High-to-Low clock (C) transition and appears at the output (Q). The clock input can be driven by internal logic or through another external pin.

This flip-flop is asynchronously cleared, outputs Low, when power is applied. For FPGA devices, power-on conditions are simulated when global set/reset (GSR) is active. GSR defaults to active-High but can be inverted by adding an inverter in front of the GSR input of the appropriate `STARTUP_architecture` symbol.

## Logic Table

Inputs		Outputs
D	C	Q
0	↓	0
1	↓	1

## Design Entry Method

This design element is only for use in schematics.

## For More Information

See the [Spartan-6 FPGA User Documentation \(User Guides and Data Sheets\)](#).



## IFD16

### Macro: 16-Bit Input D Flip-Flop

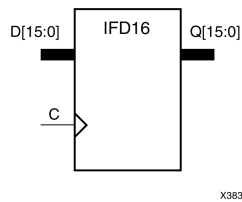

## Introduction

This D-type flip-flop is contained in an input/output block (IOB). The input (D) of the flip-flop is connected to an IPAD or an IOPAD (without using an IBUF). The (D) input provides data input for the flip-flop, which synchronizes data entering the chip. The data on input (D) is loaded into the flip-flop during the Low-to-High clock (C) transition and appears at the output (Q). The clock input can be driven by internal logic or through another external pin.

This flip-flop is asynchronously cleared, outputs Low, when power is applied. For FPGA devices, power-on conditions are simulated when global set/reset (GSR) is active. GSR defaults to active-High but can be inverted by adding an inverter in front of the GSR input of the appropriate `STARTUP_architecture` symbol.

## Logic Table

Inputs		Outputs
D	C	Q
D	↑	D

## Design Entry Method

This design element is only for use in schematics.

## For More Information

See the [Spartan-6 FPGA User Documentation \(User Guides and Data Sheets\)](#).

## IFD4

### Macro: 4-Bit Input D Flip-Flop

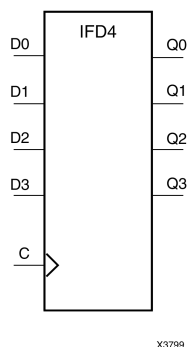

## Introduction

This D-type flip-flop is contained in an input/output block (IOB). The input (D) of the flip-flop is connected to an IPAD or an IOPAD (without using an IBUF). The (D) input provides data input for the flip-flop, which synchronizes data entering the chip. The data on input (D) is loaded into the flip-flop during the Low-to-High clock (C) transition and appears at the output (Q). The clock input can be driven by internal logic or through another external pin.

This flip-flop is asynchronously cleared, outputs Low, when power is applied. For FPGA devices, power-on conditions are simulated when global set/reset (GSR) is active. GSR defaults to active-High but can be inverted by adding an inverter in front of the GSR input of the appropriate *STARTUP\_architecture* symbol.

## Logic Table

Inputs		Outputs
D	C	Q
D	↑	D

## Design Entry Method

This design element is only for use in schematics.

## For More Information

See the [Spartan-6 FPGA User Documentation \(User Guides and Data Sheets\)](#).

## IFD8

### Macro: 8-Bit Input D Flip-Flop

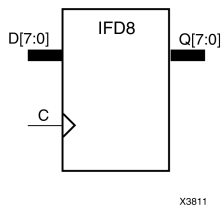

## Introduction

This D-type flip-flop is contained in an input/output block (IOB). The input (D) of the flip-flop is connected to an IPAD or an IOPAD (without using an IBUF). The (D) input provides data input for the flip-flop, which synchronizes data entering the chip. The data on input (D) is loaded into the flip-flop during the Low-to-High clock (C) transition and appears at the output (Q). The clock input can be driven by internal logic or through another external pin.

This flip-flop is asynchronously cleared, outputs Low, when power is applied. For FPGA devices, power-on conditions are simulated when global set/reset (GSR) is active. GSR defaults to active-High but can be inverted by adding an inverter in front of the GSR input of the appropriate `STARTUP_architecture` symbol.

## Logic Table

Inputs		Outputs
D	C	Q
D	↑	D

## Design Entry Method

This design element is only for use in schematics.

## For More Information

See the [Spartan-6 FPGA User Documentation \(User Guides and Data Sheets\)](#).

## IFDI

### Macro: Input D Flip-Flop (Asynchronous Preset)

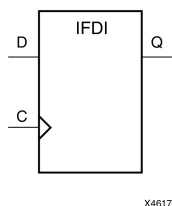

## Introduction

This design element is a D-type flip-flop which is contained in an input/output block (IOB). The input (D) of the flip-flop is connected to an IPAD or an IOPAD. The D input provides data input for the flip-flop, which synchronizes data entering the chip. The D input data is loaded into the flip-flop during the Low-to-High clock (C) transition and appears at the output (Q). The clock input can be driven by internal logic or through another external pin.

This flip-flop is asynchronously cleared, outputs Low, when power is applied. For FPGA devices, power-on conditions are simulated when global set/reset (GSR) is active. GSR defaults to active-High but can be inverted by adding an inverter in front of the GSR input of the appropriate `STARTUP_architecture` symbol.

## Logic Table

Inputs		Outputs
<b>D</b>	<b>C</b>	<b>Q</b>
D	↑	D

## Design Entry Method

This design element is only for use in schematics.

## For More Information

See the [Spartan-6 FPGA User Documentation \(User Guides and Data Sheets\)](#).

## IFDI\_1

### Macro: Input D Flip-Flop with Inverted Clock (Asynchronous Preset)

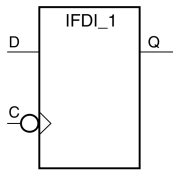

X4386

## Introduction

The design element is a D-type flip-flop is contained in an input/output block (IOB). The input (D) of the flip-flop is connected to an IPAD or an IOPAD. The (D) input provides data input for the flip-flop, which synchronizes data entering the chip. The data on input (D) is loaded into the flip-flop during the High-to-Low clock (C) transition and appears at the output (Q). The clock input can be driven by internal logic or through another external pin.

This flip-flop is asynchronously cleared, outputs Low, when power is applied. For FPGA devices, power-on conditions are simulated when global set/reset (GSR) is active. GSR defaults to active-High but can be inverted by adding an inverter in front of the GSR input of the appropriate `STARTUP_architecture` symbol.

## Logic Table

Inputs		Outputs
D	C	Q
0	↓	0
1	↓	1

## Design Entry Method

This design element is only for use in schematics.

## For More Information

See the [Spartan-6 FPGA User Documentation \(User Guides and Data Sheets\)](#).

## IFDX

### Macro: Input D Flip-Flop with Clock Enable

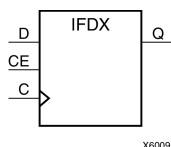

## Introduction

This D-type flip-flop is contained in an input/output block (IOB). The input (D) of the flip-flop is connected to an IPAD or an IOPAD (without using an IBUF). The D input provides data input for the flip-flop, which synchronizes data entering the chip. When CE is High, the data on input D is loaded into the flip-flop during the Low-to-High clock (C) transition and appears at the output (Q). The clock input can be driven by internal logic or through another external pin. When CE is Low, flip-flop outputs do not change.

This flip-flop is asynchronously cleared, outputs Low, when power is applied. For FPGA devices, power-on conditions are simulated when global set/reset (GSR) is active. GSR defaults to active-High but can be inverted by adding an inverter in front of the GSR input of the appropriate `STARTUP_architecture` symbol.

## Logic Table

Inputs			Outputs
CE	D	C	Q
1	D	↑	D
0	X	X	No Change

## Design Entry Method

This design element is only for use in schematics.

## For More Information

See the [Spartan-6 FPGA User Documentation \(User Guides and Data Sheets\)](#).

## IFDX\_1

### Macro: Input D Flip-Flop with Inverted Clock and Clock Enable

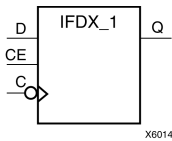

## Introduction

This design element is a D-type flip-flop is contained in an input/output block (IOB). The input (D) of the flip-flop is connected to an IPAD or an IOPAD. The D input also provides data input for the flip-flop, which synchronizes data entering the chip. When CE is High, the data on input D is loaded into the flip-flop during the High-to-Low clock (C) transition and appears at the output (Q). The clock input can be driven by internal logic or through another external pin. When the CE pin is Low, the output (Q) does not change.

This flip-flop is asynchronously cleared, outputs Low, when power is applied. For FPGA devices, power-on conditions are simulated when global set/reset (GSR) is active. GSR defaults to active-High but can be inverted by adding an inverter in front of the GSR input of the appropriate *STARTUP\_architecture* symbol.

## Logic Table

Inputs			Outputs
CE	D	C	Q
1	D	↓	D
0	X	X	No Change

## Design Entry Method

This design element is only for use in schematics.

## For More Information

See the [Spartan-6 FPGA User Documentation \(User Guides and Data Sheets\)](#).

## IFDX16

### Macro: 16-Bit Input D Flip-Flops with Clock Enable

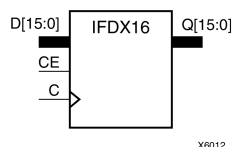

## Introduction

This D-type flip-flop is contained in an input/output block (IOB). The input (D) of the flip-flop is connected to an IPAD or an IOPAD (without using an IBUF). The D input provides data input for the flip-flop, which synchronizes data entering the chip. When CE is High, the data on input D is loaded into the flip-flop during the Low-to-High clock (C) transition and appears at the output (Q). The clock input can be driven by internal logic or through another external pin. When CE is Low, flip-flop outputs do not change.

This flip-flop is asynchronously cleared, outputs Low, when power is applied. For FPGA devices, power-on conditions are simulated when global set/reset (GSR) is active. GSR defaults to active-High but can be inverted by adding an inverter in front of the GSR input of the appropriate `STARTUP_architecture` symbol.

## Logic Table

Inputs			Outputs
CE	D	C	Q
1	D	↑	D
0	X	X	No Change

## Design Entry Method

This design element is only for use in schematics.

## For More Information

See the [Spartan-6 FPGA User Documentation \(User Guides and Data Sheets\)](#).



## IFDX4

### Macro: 4-Bit Input D Flip-Flop with Clock Enable

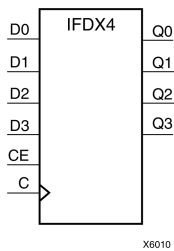

## Introduction

This D-type flip-flop is contained in an input/output block (IOB). The input (D) of the flip-flop is connected to an IPAD or an IOPAD (without using an IBUF). The D input provides data input for the flip-flop, which synchronizes data entering the chip. When CE is High, the data on input D is loaded into the flip-flop during the Low-to-High clock (C) transition and appears at the output (Q). The clock input can be driven by internal logic or through another external pin. When CE is Low, flip-flop outputs do not change.

This flip-flop is asynchronously cleared, outputs Low, when power is applied. For FPGA devices, power-on conditions are simulated when global set/reset (GSR) is active. GSR defaults to active-High but can be inverted by adding an inverter in front of the GSR input of the appropriate `STARTUP_architecture` symbol.

## Logic Table

Inputs			Outputs
CE	D	C	Q
1	D	↑	D
0	X	X	No Change

## Design Entry Method

This design element is only for use in schematics.

## For More Information

See the [Spartan-6 FPGA User Documentation \(User Guides and Data Sheets\)](#).

## IFDX8

### Macro: 8-Bit Input D Flip-Flop with Clock Enable

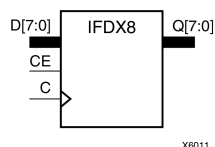

## Introduction

This D-type flip-flop is contained in an input/output block (IOB). The input (D) of the flip-flop is connected to an IPAD or an IOPAD (without using an IBUF). The D input provides data input for the flip-flop, which synchronizes data entering the chip. When CE is High, the data on input D is loaded into the flip-flop during the Low-to-High clock (C) transition and appears at the output (Q). The clock input can be driven by internal logic or through another external pin. When CE is Low, flip-flop outputs do not change.

This flip-flop is asynchronously cleared, outputs Low, when power is applied. For FPGA devices, power-on conditions are simulated when global set/reset (GSR) is active. GSR defaults to active-High but can be inverted by adding an inverter in front of the GSR input of the appropriate `STARTUP_architecture` symbol.

## Logic Table

Inputs			Outputs
CE	D	C	Q
1	D	↑	D
0	X	X	No Change

## Design Entry Method

This design element is only for use in schematics.

## For More Information

See the [Spartan-6 FPGA User Documentation \(User Guides and Data Sheets\)](#).

## IFDXI

### Macro: Input D Flip-Flop with Clock Enable (Asynchronous Preset)

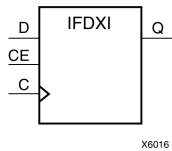

## Introduction

The design element is a D-type flip-flop is contained in an input/output block (IOB). The input (D) of the flip-flop is connected to an IPAD or an IOPAD. The D input provides data input for the flip-flop, which synchronizes data entering the chip. When CE is High, the data on input D is loaded into the flip-flop during the Low-to-High clock (C) transition and appears at the output (Q). The clock input can be driven by internal logic or through another external pin. When the CE pin is Low, the output (Q) does not change.

This flip-flop is asynchronously cleared, outputs Low, when power is applied. For FPGA devices, power-on conditions are simulated when global set/reset (GSR) is active. GSR defaults to active-High but can be inverted by adding an inverter in front of the GSR input of the appropriate `STARTUP_architecture` symbol.

## Logic Table

Inputs			Outputs
CE	D	C	Q
1	D	↑	D
0	X	X	No Change

## Design Entry Method

This design element is only for use in schematics.

## For More Information

See the [Spartan-6 FPGA User Documentation \(User Guides and Data Sheets\)](#).

## IFDXI\_1

### Macro: Input D Flip-Flop with Inverted Clock and Clock Enable (Asynchronous Preset)

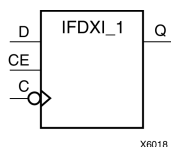

## Introduction

The design element is a D-type flip-flop that is contained in an input/output block (IOB). The input (D) of the flip-flop is connected to an IPAD or an IOPAD. The (D) input provides data input for the flip-flop, which synchronizes data entering the chip. When (CE) is High, the data on input (D) is loaded into the flip-flop during the High-to-Low clock (C) transition and appears at the output (Q). The clock input can be driven by internal logic or through another external pin. When the (CE) pin is Low, the output (Q) does not change.

This flip-flop is asynchronously cleared, outputs Low, when power is applied. For FPGA devices, power-on conditions are simulated when global set/reset (GSR) is active. GSR defaults to active-High but can be inverted by adding an inverter in front of the GSR input of the appropriate `STARTUP_architecture` symbol.

## Logic Table

Inputs			Outputs
CE	D	C	Q
1	D	↓	D
0	X	X	No Change

## Design Entry Method

This design element is only for use in schematics.

## For More Information

See the [Spartan-6 FPGA User Documentation \(User Guides and Data Sheets\)](#).

# ILD

## Macro: Transparent Input Data Latch

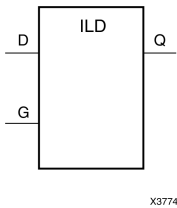

## Introduction

This design element is a single, transparent data latch that holds transient data entering a chip. This latch is contained in an input/output block (IOB). The latch input (D) is connected to an IPAD or an IOPAD (without using an IBUF). When the gate input (G) is High, data on the input (D) appears on the output (Q). Data on the D input during the High-to-Low G transition is stored in the latch.

This latch is asynchronously cleared, outputs Low, when power is applied. For FPGA devices, power-on conditions are simulated when global set/reset (GSR) is active. GSR defaults to active-High but can be inverted by adding an inverter in front of the GSR input of the appropriate `STARTUP_architecture` symbol.

## Logic Table

Inputs		Output
G	D	Q
1	D	D
0	X	No Change
↓	D	D

## Design Entry Method

This design element is only for use in schematics.

## For More Information

See the [Spartan-6 FPGA User Documentation \(User Guides and Data Sheets\)](#).

## ILD\_1

### Macro: Transparent Input Data Latch with Inverted Gate

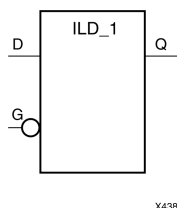

## Introduction

This design element is a transparent data latch that holds transient data entering a chip. When the gate input (G) is Low, data on the data input (D) appears on the data output (Q). Data on (D) during the Low-to-High (G) transition is stored in the latch.

This latch is asynchronously cleared, outputs Low, when power is applied. For FPGA devices, power-on conditions are simulated when global set/reset (GSR) is active. GSR defaults to active-High but can be inverted by adding an inverter in front of the GSR input of the appropriate STARTUP\_ *architecture* symbol.

## Logic Table

Inputs		Outputs
G	D	Q
0	D	D
1	X	No Change
↑	D	D

## Design Entry Method

This design element is only for use in schematics.

## For More Information

See the [Spartan-6 FPGA User Documentation \(User Guides and Data Sheets\)](#).

# ILD16

## Macro: Transparent Input Data Latch

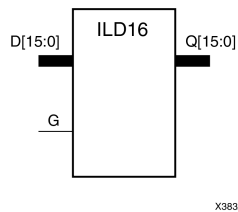

## Introduction

These design elements are multiple transparent data latches that hold transient data entering a chip. The ILD latch is contained in an input/output block (IOB). The latch input (D) is connected to an IPAD or an IOPAD (without using an IBUF). When the gate input (G) is High, data on the inputs (D) appears on the outputs (Q). Data on the D inputs during the High-to-Low G transition is stored in the latch.

This latch is asynchronously cleared, outputs Low, when power is applied. For FPGA devices, power-on conditions are simulated when global set/reset (GSR) is active. GSR defaults to active-High but can be inverted by adding an inverter in front of the GSR input of the appropriate `STARTUP_architecture` symbol.

## Logic Table

Inputs		Outputs
G	D	Q
1	Dn	Dn
0	X	No Change
↓	Dn	Dn

## Design Entry Method

This design element is only for use in schematics.

## For More Information

See the [Spartan-6 FPGA User Documentation \(User Guides and Data Sheets\)](#).

## ILD4

### Macro: Transparent Input Data Latch

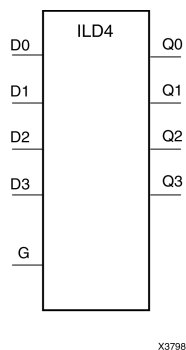

## Introduction

These design elements are multiple transparent data latches that hold transient data entering a chip. The ILD latch is contained in an input/output block (IOB). The latch input (D) is connected to an IPAD or an IOPAD (without using an IBUF). When the gate input (G) is High, data on the inputs (D) appears on the outputs (Q). Data on the D inputs during the High-to-Low G transition is stored in the latch.

This latch is asynchronously cleared, outputs Low, when power is applied. For FPGA devices, power-on conditions are simulated when global set/reset (GSR) is active. GSR defaults to active-High but can be inverted by adding an inverter in front of the GSR input of the appropriate `STARTUP_architecture` symbol.

## Logic Table

Inputs		Outputs
G	D	Q
1	Dn	Dn
0	X	No Change
↓	Dn	Dn

## Design Entry Method

This design element is only for use in schematics.

## For More Information

See the [Spartan-6 FPGA User Documentation \(User Guides and Data Sheets\)](#).



# ILD8

## Macro: Transparent Input Data Latch

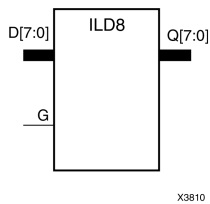

## Introduction

These design elements are multiple transparent data latches that hold transient data entering a chip. The ILD latch is contained in an input/output block (IOB). The latch input (D) is connected to an IPAD or an IOPAD (without using an IBUF). When the gate input (G) is High, data on the inputs (D) appears on the outputs (Q). Data on the D inputs during the High-to-Low G transition is stored in the latch.

This latch is asynchronously cleared, outputs Low, when power is applied. For FPGA devices, power-on conditions are simulated when global set/reset (GSR) is active. GSR defaults to active-High but can be inverted by adding an inverter in front of the GSR input of the appropriate *STARTUP\_architecture* symbol.

## Logic Table

Inputs		Outputs
G	D	Q
1	Dn	Dn
0	X	No Change
↓	Dn	Dn

## Design Entry Method

This design element is only for use in schematics.

## For More Information

See the [Spartan-6 FPGA User Documentation \(User Guides and Data Sheets\)](#).

## ILDI

### Macro: Transparent Input Data Latch (Asynchronous Preset)

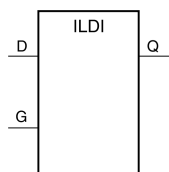

X4388

## Introduction

This design element is a transparent data latch that holds transient data entering a chip. When the gate input (G) is High, data on the input (D) appears on the output (Q). Data on the D input during the High-to-Low G transition is stored in the latch.

The ILDI is the input flip-flop master latch. It is possible to access two different outputs from the input flip-flop: one that responds to the level of the clock signal and another that responds to an edge of the clock signal. When using both outputs from the same input flip-flop, a transparent High latch (ILDI) corresponds to a falling edge-triggered flip-flop (IFDI\_1). Similarly, a transparent Low latch (ILDI\_1) corresponds to a rising edge-triggered flip-flop (IFDI).

The latch is asynchronously preset, output High, when power is applied.

For FPGA devices, power-on conditions are simulated when global set/reset (GSR) is active. GSR defaults to active-High but can be inverted by adding an inverter in front of the GSR input of the appropriate `STARTUP_architecture` symbol.

## Logic Table

Inputs		Outputs
G	D	Q
1	D	D
0	X	No Change
↓	D	D

## Design Entry Method

This design element is only for use in schematics.

## For More Information

See the [Spartan-6 FPGA User Documentation \(User Guides and Data Sheets\)](#).

## ILDI\_1

Macro: Transparent Input Data Latch with Inverted Gate (Asynchronous Preset)

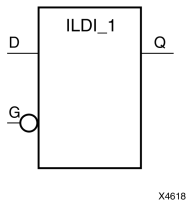

### Introduction

This design element is a transparent data latch that holds transient data entering a chip. When the gate input (G) is Low, data on the data input (D) appears on the data output (Q). Data on D during the Low-to-High G transition is stored in the latch.

The latch is asynchronously preset, output High, when power is applied.

For FPGA devices, power-on conditions are simulated when global set/reset (GSR) is active. GSR defaults to active-High but can be inverted by adding an inverter in front of the GSR input of the appropriate `STARTUP_architecture` symbol.

### Logic Table

Inputs		Outputs
G	D	Q
0	1	1
0	0	0
1	X	No Change
↑	D	D

### Design Entry Method

This design element is only for use in schematics.

### For More Information

See the [Spartan-6 FPGA User Documentation \(User Guides and Data Sheets\)](#).

## ILDX

### Macro: Transparent Input Data Latch

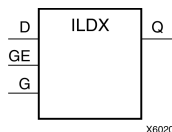

## Introduction

This design element is single or multiple transparent data latches that holds transient data entering a chip. The latch input (D) is connected to an IPAD or an IOPAD (without using an IBUF).

The ILDX is the input flip-flop master latch. Two outputs can be accessed from the input flip-flop: one that responds to the level of the clock signal and another that responds to an edge of the clock signal. When using both outputs from the same input flip-flop, a transparent High latch (ILDX) corresponds to a falling edge-triggered flip-flop (IFDX\_1). Similarly, a transparent Low latch (ILDX\_1) corresponds to a rising edge-triggered flip-flop (IFDX)

This latch is asynchronously cleared, outputs Low, when power is applied. For FPGA devices, power-on conditions are simulated when global set/reset (GSR) is active. GSR defaults to active-High but can be inverted by adding an inverter in front of the GSR input of the appropriate `STARTUP_architecture` symbol.

## Logic Table

Inputs			Outputs
GE	G	D	Q
0	X	X	No Change
1	0	X	No Change
1	1	1	1
1	1	0	0
1	↓	D	D

## Design Entry Method

This design element is only for use in schematics.

## For More Information

See the [Spartan-6 FPGA User Documentation \(User Guides and Data Sheets\)](#).

## ILDX\_1

### Macro: Transparent Input Data Latch with Inverted Gate

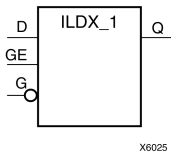

## Introduction

This design element is a transparent data latch that holds transient data entering a chip. When the gate input (G) is Low, data on the data input (D) appears on the data output (Q). Data on D during the Low-to-High G transition is stored in the latch.

This latch is asynchronously cleared, outputs Low, when power is applied. For FPGA devices, power-on conditions are simulated when global set/reset (GSR) is active. GSR defaults to active-High but can be inverted by adding an inverter in front of the GSR input of the appropriate *STARTUP\_architecture* symbol.

## Logic Table

Inputs			Outputs
GE	G	D	Q
0	X	X	No Change
1	1	X	No Change
1	0	1	1
1	0	0	0
1	↑	D	D

## Design Entry Method

This design element is only for use in schematics.

## For More Information

See the [Spartan-6 FPGA User Documentation \(User Guides and Data Sheets\)](#).

## ILDX16

### Macro: Transparent Input Data Latch

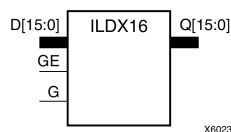

## Introduction

This design element is single or multiple transparent data latches that holds transient data entering a chip. The latch input (D) is connected to an IPAD or an IOPAD (without using an IBUF).

The ILDX is the input flip-flop master latch. Two outputs can be accessed from the input flip-flop: one that responds to the level of the clock signal and another that responds to an edge of the clock signal. When using both outputs from the same input flip-flop, a transparent High latch (ILDX) corresponds to a falling edge-triggered flip-flop (IFDX\_1). Similarly, a transparent Low latch (ILDX\_1) corresponds to a rising edge-triggered flip-flop (IFDX)

This latch is asynchronously cleared, outputs Low, when power is applied. For FPGA devices, power-on conditions are simulated when global set/reset (GSR) is active. GSR defaults to active-High but can be inverted by adding an inverter in front of the GSR input of the appropriate `STARTUP_architecture` symbol.

## Logic Table

Inputs			Outputs
GE	G	D	Q
0	X	X	No Change
1	0	X	No Change
1	1	Dn	Dn

## Design Entry Method

This design element is only for use in schematics.

## For More Information

See the [Spartan-6 FPGA User Documentation \(User Guides and Data Sheets\)](#).

# ILDX4

## Macro: Transparent Input Data Latch

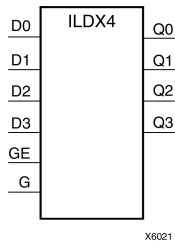

## Introduction

This design element is single or multiple transparent data latches that holds transient data entering a chip. The latch input (D) is connected to an IPAD or an IOPAD (without using an IBUF).

The ILDX is the input flip-flop master latch. Two outputs can be accessed from the input flip-flop: one that responds to the level of the clock signal and another that responds to an edge of the clock signal. When using both outputs from the same input flip-flop, a transparent High latch (ILDX) corresponds to a falling edge-triggered flip-flop (IFDX\_1). Similarly, a transparent Low latch (ILDX\_1) corresponds to a rising edge-triggered flip-flop (IFDX)

This latch is asynchronously cleared, outputs Low, when power is applied. For FPGA devices, power-on conditions are simulated when global set/reset (GSR) is active. GSR defaults to active-High but can be inverted by adding an inverter in front of the GSR input of the appropriate STARTUP\_architecture symbol.

## Logic Table

Inputs			Outputs
GE	G	D	Q
0	X	X	No Change
1	1	X	No Change
1	0	1	1
1	0	0	0
1	↑	Dn	Dn

## Design Entry Method

This design element is only for use in schematics.

## For More Information

See the [Spartan-6 FPGA User Documentation \(User Guides and Data Sheets\)](#).

## ILDX8

### Macro: Transparent Input Data Latch

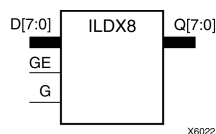

## Introduction

This design element is single or multiple transparent data latches that holds transient data entering a chip. The latch input (D) is connected to an IPAD or an IOPAD (without using an IBUF).

The ILDX is the input flip-flop master latch. Two outputs can be accessed from the input flip-flop: one that responds to the level of the clock signal and another that responds to an edge of the clock signal. When using both outputs from the same input flip-flop, a transparent High latch (ILDX) corresponds to a falling edge-triggered flip-flop (IFDX\_1). Similarly, a transparent Low latch (ILDX\_1) corresponds to a rising edge-triggered flip-flop (IFDX)

This latch is asynchronously cleared, outputs Low, when power is applied. For FPGA devices, power-on conditions are simulated when global set/reset (GSR) is active. GSR defaults to active-High but can be inverted by adding an inverter in front of the GSR input of the appropriate *STARTUP\_architecture* symbol.

## Logic Table

Inputs			Outputs
GE	G	D	Q
0	X	X	No Change
1	0	X	No Change
1	1	Dn	Dn

## Design Entry Method

This design element is only for use in schematics.

## For More Information

See the [Spartan-6 FPGA User Documentation \(User Guides and Data Sheets\)](#).



# ILDXI

## Macro: Transparent Input Data Latch (Asynchronous Preset)

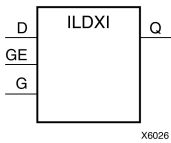

### Introduction

This design element is a transparent data latch that holds transient data entering a chip. When the gate input (G) is High, data on the input (D) appears on the output (Q). Data on the (D) input during the High-to-Low (G) transition is stored in the latch.

The ILDXI is the input flip-flop master latch. Two outputs can be accessed from the input flip-flop: one that responds to the level of the clock signal and another that responds to an edge of the clock signal. When using both outputs from the same input flip-flop, a transparent High latch (ILDXI) corresponds to a falling edge-triggered flip-flop (IFDXI\_1). Similarly, a transparent Low latch (ILDXI\_1) corresponds to a rising edge-triggered flip-flop (IFDXI).

The latch is asynchronously preset, output High, when power is applied.

For FPGA devices, power-on conditions are simulated when global set/reset (GSR) is active. GSR defaults to active-High but can be inverted by adding an inverter in front of the GSR input of the appropriate `STARTUP_architecture` symbol.

### Logic Table

Inputs			Outputs
GE	G	D	Q
0	X	X	No Change
1	0	X	No Change
1	1	D	D
1	↓	D	D

### Design Entry Method

This design element is only for use in schematics.

### For More Information

See the [Spartan-6 FPGA User Documentation \(User Guides and Data Sheets\)](#).

## ILDXI\_1

Macro: Transparent Input Data Latch with Inverted Gate (Asynchronous Preset)

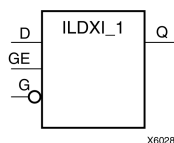

### Introduction

This design element is a transparent data latch that holds transient data entering a chip.

The latch is asynchronously preset, output High, when power is applied.

For FPGA devices, power-on conditions are simulated when global set/reset (GSR) is active. GSR defaults to active-High but can be inverted by adding an inverter in front of the GSR input of the appropriate *STARTUP\_architecture* symbol.

### Logic Table

Inputs			Outputs
GE	G	D	Q
0	X	X	No Change
1	1	X	No Change
1	0	D	D
1	↑	D	D

### Design Entry Method

This design element is only for use in schematics.

### For More Information

See the [Spartan-6 FPGA User Documentation \(User Guides and Data Sheets\)](#).

## INV

### Primitive: Inverter

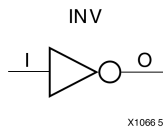

## Introduction

This design element is a single inverter that identifies signal inversions in a schematic.

## Design Entry Method

This design element is only for use in schematics.

## For More Information

See the [Spartan-6 FPGA User Documentation \(User Guides and Data Sheets\)](#).

## INV16

Macro: 16 Inverters

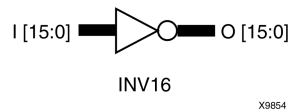

### Introduction

This design element is a multiple inverter that identifies signal inversions in a schematic.

### Design Entry Method

This design element is only for use in schematics.

### For More Information

See the [Spartan-6 FPGA User Documentation \(User Guides and Data Sheets\)](#).

## INV4

### Macro: Four Inverters

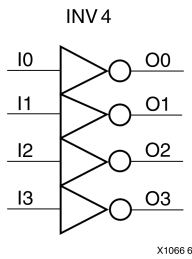

### Introduction

This design element is a multiple inverter that identifies signal inversions in a schematic.

### Design Entry Method

This design element is only for use in schematics.

### For More Information

See the [Spartan-6 FPGA User Documentation \(User Guides and Data Sheets\)](#).

## INV8

### Macro: Eight Inverters

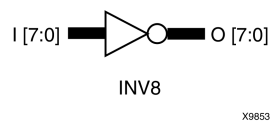

## Introduction

This design element is a multiple inverter that identifies signal inversions in a schematic.

## Design Entry Method

This design element is only for use in schematics.

## For More Information

See the [Spartan-6 FPGA User Documentation \(User Guides and Data Sheets\)](#).

# IOBUF

## Primitive: Bi-Directional Buffer

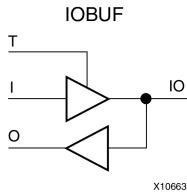

## Introduction

The design element is a bidirectional single-ended I/O Buffer used to connect internal logic to an external bidirectional pin.

## Logic Table

Inputs		Bidirectional	Outputs
T	I	IO	O
1	X	Z	IO
0	1	1	1
0	0	0	0

## Port Descriptions

Port	Direction	Width	Function
O	Output	1	Buffer output
IO	Inout	1	Buffer inout
I	Input	1	Buffer input
T	Input	1	3-State enable input

## Design Entry Method

This design element can be used in schematics.

## Available Attributes

Attribute	Data Type	Allowed Values	Default	Description
DRIVE	Integer	2, 4, 6, 8, 12, 16, 24	12	Selects output drive strength (mA) for the SelectIO™ buffers that use the LVTTTL, LVCMOS12, LVCMOS15, LVCMOS18, LVCMOS25, or LVCMOS33 interface I/O standard.
IOSTANDARD	String	See Data Sheet	"DEFAULT"	Assigns an I/O standard to the element.
SLEW	String	"SLOW", "FAST", "QUIETIO"	"SLOW"	Sets the output rise and fall time. See the Data Sheet for recommendations of the best setting for this attribute.

## For More Information

- See the [Spartan-6 FPGA SelectIO Resources User Guide \(UG381\)](#).
- See the [Spartan-6 FPGA Data Sheet: DC and Switching Characteristics \(DS162\)](#).



## IOBUFDS

### Primitive: 3-State Differential Signaling I/O Buffer with Active Low Output Enable

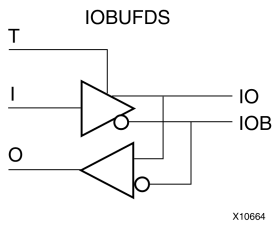

## Introduction

The design element is a bidirectional buffer that supports low-voltage, differential signaling. For the IOBUFDS, a design level interface signal is represented as two distinct ports (IO and IOB), one deemed the "master" and the other the "slave." The master and the slave are opposite phases of the same logical signal (for example, MYNET\_P and MYNET\_N). Optionally, a programmable differential termination feature is available to help improve signal integrity and reduce external components. Also available is a programmable delay is to assist in the capturing of incoming data to the device.

## Logic Table

Inputs		Bidirectional		Outputs
I	T	IO	IOB	O
X	1	Z	Z	No Change
0	0	0	1	0
1	0	1	0	1

## Port Descriptions

Port	Direction	Width	Function
O	Output	1	Buffer output
IO	Inout	1	Diff_p inout
IOB	Inout	1	Diff_n inout
I	Input	1	Buffer input
T	Input	1	3-state enable input

## Design Entry Method

This design element can be used in schematics.

## Available Attributes

Attribute	Data Type	Allowed Values	Default	Description
IOSTANDARD	String	See Data Sheet	"DEFAULT"	Assigns an I/O standard to the element.

## For More Information

- See the [Spartan-6 FPGA SelectIO Resources User Guide \(UG381\)](#).
- See the [Spartan-6 FPGA Data Sheet: DC and Switching Characteristics \(DS162\)](#).

# IODELAY2

## Primitive: Input and Output Fixed or Variable Delay Element

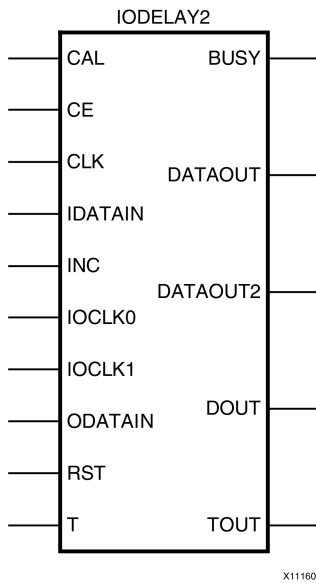

### Introduction

This design element can be used to provide a fixed delay or an adjustable delay to the input path and a fixed delay for the output path of the Spartan®-6 FPGA. This delay can be useful for data alignment of incoming or outgoing data to/from the chip. When used in variable mode, the input path can be adjusted for increasing and decreasing amounts of delay. The output delay path is only available in a fixed delay. The IODELAY can also be used to add additional static or variable delay to an internal path (within the FPGA fabric). However, when IODELAY is used that way, this device is no longer available to the associated I/O for input or output path delays.

### Port Descriptions

Port	Direction	Width	Function
BUSY	Output	1	Busy after CAL.
CAL	Input	1	Initiate calibration input.
CE	Input	1	Enable increment/decrement.
CLK	Input	1	IODELAY Clock input.
DATAOUT	Output	1	Delayed Data output from input port (connect to input datapath logic, can only route to a register in ILOGIC).
DATAOUT2	Output	1	Delayed Data output from input port (connect to input datapath logic, can route to fabric).
DOUT	Output	1	Delayed Data Output to IOB.
IDATAIN	Input	1	Data Signal from IOB.
INC	Input	1	Increment / Decrement Input.
IOCLK0	Input	1	Optionally Invertible I/O clock inputs.
IOCLK1	Input	1	Optionally Invertible I/O clock inputs.

Port	Direction	Width	Function
ODATAIN	Input	1	Output Data Input from OLOGIC or OSERDES.
RST	Input	1	Reset the IODELAY2 to either zero or 1/2 of total period. RST_VALUE attribute controls this choice.
T	Input	1	3-state input control. Tie high for input-only or internal delay or tie low for output only.
TOUT	Output	1	Delayed 3-state signal output. Tie high for input-only or internal delay or tie low for output only.

## Design Entry Method

This design element can be used in schematics.

## Available Attributes

Attribute	Data Type	Allowed Values	Default	Description
COUNTER_WRAP AROUND	String	"WRAPAROUND", "STAY_AT_LIMIT"	"WRAPAROUND"	Sets behavior when tap count exceeds max or min, depending on whether tap setting is being incremented or decremented.
DATA_RATE	String	"SDR", "DDR"	"SDR"	Single Data Rate or Double Data Rate operation.
DELAY_SRC	String	"IO", "IDATAIN", "ODATAIN"	"IO"	<ul style="list-style-type: none"> <li>ODATAIN indicates delay source is the ODATAIN pin from the OSERDES or OLOGIC.</li> <li>IDATAIN indicates the delay source is from the IDATAIN pin; one of the dedicated IOB (P/N) Pads.</li> <li>IO means that the signal source switches between IDATAIN and ODATAIN depending on the sense of the T (tristate) input.</li> </ul>
IDELAY_MODE	String	"NORMAL", "PCI"	"NORMAL"	Do not specify or modify this attribute.
IDELAY_TYPE	String	"DEFAULT", "DIFF_PHASE_ DETECTOR", "FIXED", "VARIABLE_FROM_ HALF_MAX", "VARIABLE_FROM_ ZERO"	"DEFAULT"	Delay Type. VARIABLE refers to the customer calibrated delay mode. <ul style="list-style-type: none"> <li>DEFAULT utilizes physical chip settings for best approximation of zero hold time programming.</li> <li>VARIABLE_FROM_ZERO and VARIABLE_FROM_HALF_MAX refer to the reset behavior.</li> <li>DIFF_PHASE_DETECTOR is a special mode where</li> </ul>

Attribute	Data Type	Allowed Values	Default	Description
				the master and slave IODELAY2s are cascaded.
IDELAY_VALUE	Integer	0 to 255	0	Delay tap value for IDELAY Mode.
IDELAY2_VALUE	Integer	0 to 255	0	Delay tap value for IDELAY Mode. Only used when IDELAY_MODE is set to PCI.
ODELAY_VALUE	Integer	0 to 255	0	Delay tap value for ODELAY Mode.
SERDES_MODE	String	"NONE", "MASTER", "SLAVE"	"NONE"	Specify whether the ISERDES2 is operating in master or slave modes when cascaded width expansion.
SIM_TAPDELAY_VALUE	Integer	10 to 90	75	A simulation only attribute. Allows setting the nominal tap delay to different settings for simulation.

## For More Information

- See the [Spartan-6 FPGA SelectIO Resources User Guide \(UG381\)](#).
- See the [Spartan-6 FPGA Data Sheet: DC and Switching Characteristics \(DS162\)](#).

## IODRP2

Primitive: I/O Control Port

### Introduction

Xilinx does not support the use of this element.

### For More Information

- See the [Spartan-6 FPGA SelectIO Resources User Guide \(UG381\)](#).
- See the [Spartan-6 FPGA Data Sheet: DC and Switching Characteristics \(DS162\)](#).

# ISERDES2

Primitive: Input SERial/DESerializer.

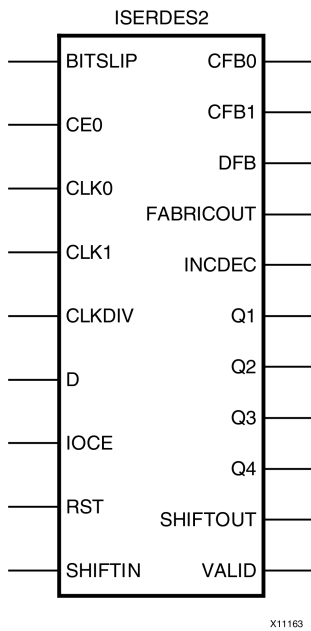

## Introduction

Each IOB contains an input deserializer block that can be instantiated in a design by using the ISERDES2 primitive. ISERDES2 allows serial-to-parallel conversion with SerDes ratios of 1:2, 1:3 and 1:4. The SerDes ratio is the ratio between the high speed I/O clock that is capturing data, and the slower internal global clock used for processing the parallel data. For example, with a single-rate I/O clock running at 500 MHz to receive data at 500 Mb/s, the ISERDES2 transfers four bits of data at one quarter of the rate (125 MHz) to the FPGA logic. When using differential inputs, the two ISERDES2 primitives associated with the two IOBs can be cascaded to allow higher SerDes ratios of 1:5, 1:6, 1:7, and 1:8. Each ISERDES2 also contains logic to word-align the parallel data, as required by the designer, by performing a Bitflip operation.

## Port Descriptions

Port	Direction	Width	Function
BITSLLIP	Input	1	Invoke Bitflip when High. Bitflip operation can be used with any DATA_WIDTH, cascaded or not. The amount of Bitflip is fixed by the DATA_WIDTH selection.
CE0	Input	1	Clock enable input for final (global clock driven) register.
CFB0	Output	1	Feed-through route to allow a PLL or DCM generated clock to feed back to the PLL or DCM through a BUFIO2FB.
CFB1	Output	1	Secondary feed-through route to allow a PLL or DCM generated clock to feed back to the PLL or DCM through a BUFIO2FB.
CLKDIV	Input	1	Global clock network input. This is the clock for the FPGA logic domain.
CLK0	Input	1	I/O clock network input. Optionally invertible. This is the primary clock input used when the clock doubler circuit is not engaged.(see DATA_RATE attribute).

Port	Direction	Width	Function
CLK1	Input	1	I/O clock network input. Optionally invertible. This secondary clock input is only used when the clock doubler is engaged (see DATA_RATE attribute).
D	Input	1	Input data. This is the data input after being delayed by the IODELAY2 block.
DFB	Output	1	Feed-through route to allow an input clock that has been delayed in an IODELAY2 element to be forwarded to a DCM, PLL, or BUFG through a BUFIO2.
FABRICOUT	Output	1	Asynchronous data for use in the FPGA logic.
INCDEC	Output	1	Output of phase detector in master mode (dummy in slave mode). Indicates to the FPGA logic whether the received data was sampled early or late.
IOCE	Input	1	Data strobe signal derived from BUFIO CE. Strobes data capture to be correctly timed with respect to the I/O and global clocks for the SerDes mode selected.
Q1 - Q4	Output	1	Registered output to fabric.
RST	Input	1	Asynchronous reset only.
SHIFTIN	Input	1	Cascade-in signal for master/slave I/O. Used when master and slave sites are used together for DATA_WIDTHs greater than four. When the block is a master, it transfers data in for use in the phase-detector mode. When the block is a slave, it transfers serial data in to become parallel data.
SHIFTOUT	Output	1	Cascade-out signal for master/slave I/O. In slave mode, it is used to send sampled data from the slave. In master mode, it sends serial data from the fourth stage of the input shift register to the slave.
VALID	Output	1	Output of the phase detector in master mode (dummy in slave mode). If the input data contains no edges (no information for the phase detector to work with) the VALID signal transitions Low to indicate that the FPGA logic should ignore the INCDEC signal.

## Design Entry Method

This design element can be used in schematics.

## Available Attributes

Attribute	Data Type	Allowed Values	Default	Description
BITSLIP_ENABLE	Boolean	FALSE, TRUE	FALSE	Enables or disables the Bitslip function controlled by the BITSLIP input pin. The number of bits slipped is a function of the DATA_WIDTH selected. When disabled, the Bitslip CE always remains at the default value of one I/O clock before the IOCE clock enable.
DATA_RATE	String	"SDR", "DDR"	"SDR"	Data rate setting. The DDR clock can be supplied by separate I/O clocks or by a single I/O clock. If two clocks are supplied, they must be approximately 180 degrees out of phase.



Attribute	Data Type	Allowed Values	Default	Description
DATA_WIDTH	Integer	1, 2, 3, 4, 5, 6, 7, 8	1	Data width. Defines the parallel data output width of the serial-to-parallel converter. Values greater than four are only valid when two ISERDES2 blocks are cascaded. In this case, the same value should be applied to both the master and slave blocks.
INTERFACE_TYPE	String	"NETWORKING", "NETWORKING_PIPELINED", "RETIMED"	"NETWORKING"	Selects mode of operation and determines which set of parallel data is available to the FPGA logic.
SERDES_MODE	String	"NONE", "MASTER", "SLAVE"	"NONE"	Indicates if the ISERDES is being used alone, or as a master or slave, when two ISERDES2 blocks are cascaded.

## For More Information

- See the [Spartan-6 FPGA SelectIO Resources User Guide](#)
- See the [Spartan-6 FPGA Data Sheet: DC and Switching Characteristics](#).

## KEEPER

### Primitive: KEEPER Symbol

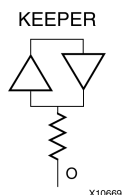

## Introduction

The design element is a weak keeper element that retains the value of the net connected to its bidirectional O pin. For example, if a logic 1 is being driven onto the net, KEEPER drives a weak/resistive 1 onto the net. If the net driver is then 3-stated, KEEPER continues to drive a weak/resistive 1 onto the net.

## Port Descriptions

Name	Direction	Width	Function
O	Output	1-Bit	Keeper output

## Design Entry Method

This design element can be used in schematics or instantiated in HDL code. Instantiation templates for VHDL and Verilog are available below.

This element can be connected to a net in the following locations on a top-level schematic file:

- A net connected to an input IO Marker
- A net connected to both an output IO Marker and 3-statable IO element, such as an OBUFT.

## For More Information

- See the [Spartan-6 FPGA SelectIO Resources User Guide \(UG381\)](#).
- See the [Spartan-6 FPGA Data Sheet: DC and Switching Characteristics \(DS162\)](#).

## LD

### Primitive: Transparent Data Latch

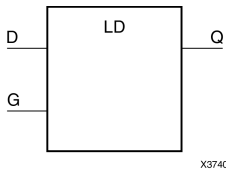

## Introduction

LD is a transparent data latch. The data output (Q) of the latch reflects the data (D) input while the gate enable (G) input is High. The data on the (D) input during the High-to-Low gate transition is stored in the latch. The data on the (Q) output remains unchanged as long as (G) remains Low.

This latch is asynchronously cleared, outputs Low, when power is applied. For FPGA devices, power-on conditions are simulated when global set/reset (GSR) is active. GSR defaults to active-High but can be inverted by adding an inverter in front of the GSR input of the appropriate `STARTUP_architecture` symbol.

## Logic Table

Inputs		Outputs
G	D	Q
1	D	D
0	X	No Change
↓	D	D

## Design Entry Method

This design element is only for use in schematics.

## Available Attributes

Attribute	Data Type	Allowed Values	Default	Description
INIT	Binary	0, 1	0	Sets the initial value of Q output after configuration

## For More Information

See the [Spartan-6 FPGA User Documentation \(User Guides and Data Sheets\)](#).

## LD\_1

### Primitive: Transparent Data Latch with Inverted Gate

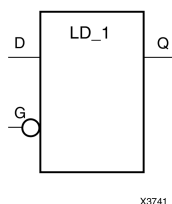

## Introduction

This design element is a transparent data latch with an inverted gate. The data output (Q) of the latch reflects the data (D) input while the gate enable (G) input is Low. The data on the (D) input during the Low-to-High gate transition is stored in the latch. The data on the (Q) output remains unchanged as long as (G) remains High.

This latch is asynchronously cleared, outputs Low, when power is applied. For FPGA devices, power-on conditions are simulated when global set/reset (GSR) is active. GSR defaults to active-High but can be inverted by adding an inverter in front of the GSR input of the appropriate `STARTUP_architecture` symbol.

## Logic Table

Inputs		Outputs
G	D	Q
0	D	D
1	X	No Change
↑	D	D

## Design Entry Method

This design element is only for use in schematics.

## Available Attributes

Attribute	Data Type	Allowed Values	Default	Description
INIT	Binary	0, 1	0	Sets the initial value of Q output after configuration.

## For More Information

See the [Spartan-6 FPGA User Documentation \(User Guides and Data Sheets\)](#).

# LD16

## Macro: Multiple Transparent Data Latch

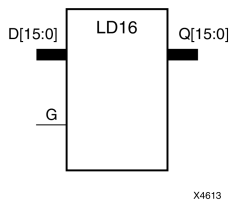

## Introduction

This design element has 16 transparent data latches with a common gate enable (G). The data output (Q) of the latch reflects the data (D) input while the gate enable (G) input is High. The data on the (D) input during the High-to-Low gate transition is stored in the latch. The data on the (Q) output remains unchanged as long as (G) remains Low.

This latch is asynchronously cleared, outputs Low, when power is applied. For FPGA devices, power-on conditions are simulated when global set/reset (GSR) is active. GSR defaults to active-High but can be inverted by adding an inverter in front of the GSR input of the appropriate *STARTUP\_architecture* symbol.

## Logic Table

Inputs		Outputs
G	D	Q
1	Dn	Dn
0	X	No Change
↓	Dn	Dn

## Design Entry Method

This design element is only for use in schematics.

## Available Attributes

Attribute	Data Type	Allowed Values	Default	Description
INIT	Binary	Any 16-Bit Value	All zeros	Sets the initial value of Q output after configuration

## For More Information

See the [Spartan-6 FPGA User Documentation \(User Guides and Data Sheets\)](#).

## LD16CE

### Macro: Transparent Data Latch with Asynchronous Clear and Gate Enable

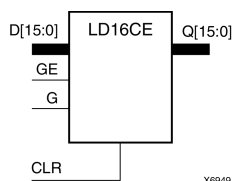

## Introduction

This design element has 16 transparent data latches with asynchronous clear and gate enable. When the asynchronous clear input (CLR) is High, it overrides the other inputs and resets the data (Q) outputs Low. (Q) reflects the data (D) inputs while the gate (G) and gate enable (GE) are High, and (CLR) is Low. If (GE) is Low, data on (D) cannot be latched. The data on the (D) input during the High-to-Low gate transition is stored in the latch. The data on the (Q) output remains unchanged as long as (G) or (GE) remains Low.

This latch is asynchronously cleared, outputs Low, when power is applied. For FPGA devices, power-on conditions are simulated when global set/reset (GSR) is active. GSR defaults to active-High but can be inverted by adding an inverter in front of the GSR input of the appropriate `STARTUP_architecture` symbol.

## Logic Table

Inputs				Outputs
CLR	GE	G	Dn	Qn
1	X	X	X	0
0	0	X	X	No Change
0	1	1	Dn	Dn
0	1	0	X	No Change
0	1	↓	Dn	Dn

## Design Entry Method

This design element is only for use in schematics.

## Available Attributes

Attribute	Data Type	Allowed Values	Default	Description
INIT	Binary	Any 16-Bit Value	All zeros	Sets the initial value of Q output after configuration

## For More Information

See the [Spartan-6 FPGA User Documentation \(User Guides and Data Sheets\)](#).

# LD4

## Macro: Multiple Transparent Data Latch

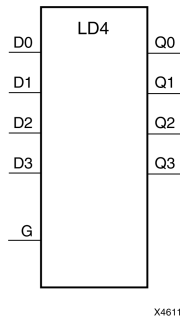

### Introduction

This design element has four transparent data latches with a common gate enable (G). The data output (Q) of the latch reflects the data (D) input while the gate enable (G) input is High. The data on the (D) input during the High-to-Low gate transition is stored in the latch. The data on the (Q) output remains unchanged as long as (G) remains Low.

This latch is asynchronously cleared, outputs Low, when power is applied. For FPGA devices, power-on conditions are simulated when global set/reset (GSR) is active. GSR defaults to active-High but can be inverted by adding an inverter in front of the GSR input of the appropriate STARTUP\_architecture symbol.

### Logic Table

Inputs		Outputs
G	D	Q
1	Dn	Dn
0	X	No Change
↓	Dn	Dn

### Design Entry Method

This design element is only for use in schematics.

### Available Attributes

Attribute	Data Type	Allowed Values	Default	Description
INIT	Binary	Any 4-Bit Value	All zeros	Sets the initial value of Q output after configuration

### For More Information

See the [Spartan-6 FPGA User Documentation \(User Guides and Data Sheets\)](#).

## LD4CE

### Macro: Transparent Data Latch with Asynchronous Clear and Gate Enable

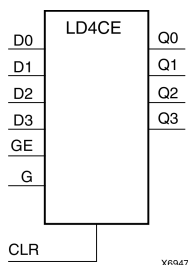

## Introduction

This design element has 4 transparent data latches with asynchronous clear and gate enable. When the asynchronous clear input (CLR) is High, it overrides the other inputs and resets the data (Q) outputs Low. (Q) reflects the data (D) inputs while the gate (G) and gate enable (GE) are High, and (CLR) is Low. If (GE) is Low, data on (D) cannot be latched. The data on the (D) input during the High-to-Low gate transition is stored in the latch. The data on the (Q) output remains unchanged as long as (G) or (GE) remains Low.

This latch is asynchronously cleared, outputs Low, when power is applied. For FPGA devices, power-on conditions are simulated when global set/reset (GSR) is active. GSR defaults to active-High but can be inverted by adding an inverter in front of the GSR input of the appropriate `STARTUP_architecture` symbol.

## Logic Table

Inputs				Outputs
CLR	GE	G	Dn	Qn
1	X	X	X	0
0	0	X	X	No Change
0	1	1	Dn	Dn
0	1	0	X	No Change
0	1	↓	Dn	Dn

## Design Entry Method

This design element is only for use in schematics.

## Available Attributes

Attribute	Data Type	Allowed Values	Default	Description
INIT	Binary	Any 4-Bit Value	All zeros	Sets the initial value of Q output after configuration

## For More Information

See the [Spartan-6 FPGA User Documentation \(User Guides and Data Sheets\)](#).



# LD8

## Macro: Multiple Transparent Data Latch

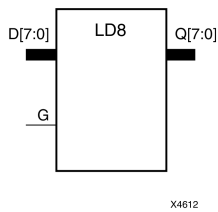

## Introduction

This design element has 8 transparent data latches with a common gate enable (G). The data output (Q) of the latch reflects the data (D) input while the gate enable (G) input is High. The data on the (D) input during the High-to-Low gate transition is stored in the latch. The data on the (Q) output remains unchanged as long as (G) remains Low.

This latch is asynchronously cleared, outputs Low, when power is applied. For FPGA devices, power-on conditions are simulated when global set/reset (GSR) is active. GSR defaults to active-High but can be inverted by adding an inverter in front of the GSR input of the appropriate `STARTUP_architecture` symbol.

## Logic Table

Inputs		Outputs
G	D	Q
1	Dn	Dn
0	X	No Change
↓	Dn	Dn

## Design Entry Method

This design element is only for use in schematics.

## Available Attributes

Attribute	Data Type	Allowed Values	Default	Description
INIT	Binary	Any 8-Bit Value	All zeros	Sets the initial value of Q output after configuration

## For More Information

See the [Spartan-6 FPGA User Documentation \(User Guides and Data Sheets\)](#).

## LD8CE

### Macro: Transparent Data Latch with Asynchronous Clear and Gate Enable

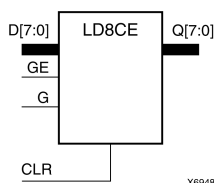

## Introduction

This design element has 8 transparent data latches with asynchronous clear and gate enable. When the asynchronous clear input (CLR) is High, it overrides the other inputs and resets the data (Q) outputs Low. (Q) reflects the data (D) inputs while the gate (G) and gate enable (GE) are High, and (CLR) is Low. If (GE) is Low, data on (D) cannot be latched. The data on the (D) input during the High-to-Low gate transition is stored in the latch. The data on the (Q) output remains unchanged as long as (G) or (GE) remains Low.

This latch is asynchronously cleared, outputs Low, when power is applied. For FPGA devices, power-on conditions are simulated when global set/reset (GSR) is active. GSR defaults to active-High but can be inverted by adding an inverter in front of the GSR input of the appropriate *STARTUP\_architecture* symbol.

## Logic Table

Inputs				Outputs
CLR	GE	G	Dn	Qn
1	X	X	X	0
0	0	X	X	No Change
0	1	1	Dn	Dn
0	1	0	X	No Change
0	1	↓	Dn	Dn

## Design Entry Method

This design element is only for use in schematics.

## Available Attributes

Attribute	Data Type	Allowed Values	Default	Description
INIT	Binary	Any 8-Bit Value	All zeros	Sets the initial value of Q output after configuration.

## For More Information

See the [Spartan-6 FPGA User Documentation \(User Guides and Data Sheets\)](#).

# LDC

## Primitive: Transparent Data Latch with Asynchronous Clear

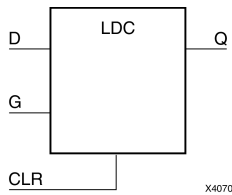

## Introduction

This design element is a transparent data latch with asynchronous clear. When the asynchronous clear input (CLR) is High, it overrides the other inputs and resets the data (Q) output Low. (Q) reflects the data (D) input while the gate enable (G) input is High and (CLR) is Low. The data on the (D) input during the High-to-Low gate transition is stored in the latch. The data on the (Q) output remains unchanged as long as (G) remains low.

This latch is asynchronously cleared, outputs Low, when power is applied. For FPGA devices, power-on conditions are simulated when global set/reset (GSR) is active. GSR defaults to active-High but can be inverted by adding an inverter in front of the GSR input of the appropriate STARTUP\_architecture symbol.

## Logic Table

Inputs			Outputs
CLR	G	D	Q
1	X	X	0
0	1	D	D
0	0	X	No Change
0	↓	D	D

## Design Entry Method

This design element is only for use in schematics.

## Available Attributes

Attribute	Data Type	Allowed Values	Default	Description
INIT	Binary	0, 1	0	Sets the initial value of Q output after configuration.

## For More Information

See the [Spartan-6 FPGA User Documentation \(User Guides and Data Sheets\)](#).

## LDC\_1

### Primitive: Transparent Data Latch with Asynchronous Clear and Inverted Gate

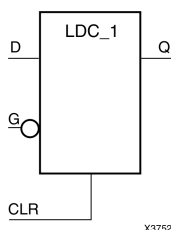

## Introduction

This design element is a transparent data latch with asynchronous clear and inverted gate. When the asynchronous clear input (CLR) is High, it overrides the other inputs (D and G) and resets the data (Q) output Low. (Q) reflects the data (D) input while the gate enable (G) input and CLR are Low. The data on the (D) input during the Low-to-High gate transition is stored in the latch. The data on the (Q) output remains unchanged as long as (G) remains High.

This latch is asynchronously cleared, outputs Low, when power is applied. For FPGA devices, power-on conditions are simulated when global set/reset (GSR) is active. GSR defaults to active-High but can be inverted by adding an inverter in front of the GSR input of the appropriate `STARTUP_architecture` symbol.

## Logic Table

Inputs			Outputs
CLR	G	D	Q
1	X	X	0
0	0	D	D
0	1	X	No Change
0	↑	D	D

## Design Entry Method

This design element is only for use in schematics.

## Available Attributes

Attribute	Data Type	Allowed Values	Default	Description
INIT	Binary	0, 1	0	Sets the initial value of Q output after configuration.

## For More Information

See the [Spartan-6 FPGA User Documentation \(User Guides and Data Sheets\)](#).

## LDCE

### Primitive: Transparent Data Latch with Asynchronous Clear and Gate Enable

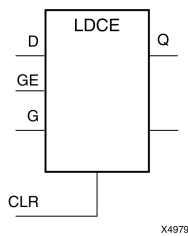

## Introduction

This design element is a transparent data latch with asynchronous clear and gate enable. When the asynchronous clear input (CLR) is High, it overrides the other inputs and resets the data (Q) output Low. Q reflects the data (D) input while the gate (G) input and gate enable (GE) are High and CLR is Low. If (GE) is Low, data on (D) cannot be latched. The data on the (D) input during the High-to-Low gate transition is stored in the latch. The data on the (Q) output remains unchanged as long as (G) or (GE) remains low.

This latch is asynchronously cleared, outputs Low, when power is applied. For FPGA devices, power-on conditions are simulated when global set/reset (GSR) is active. GSR defaults to active-High but can be inverted by adding an inverter in front of the GSR input of the appropriate `STARTUP_architecture` symbol.

## Logic Table

Inputs				Outputs
CLR	GE	G	D	Q
1	X	X	X	0
0	0	X	X	No Change
0	1	1	D	D
0	1	0	X	No Change
0	1	↓	D	D

## Design Entry Method

This design element can be used in schematics.

## Available Attributes

Attribute	Data Type	Allowed Values	Default	Description
INIT	Binary	0, 1	0	Sets the initial value of Q output after configuration.

## For More Information

See the [Spartan-6 FPGA User Documentation \(User Guides and Data Sheets\)](#).

## LDCE\_1

Primitive: Transparent Data Latch with Asynchronous Clear, Gate Enable, and Inverted Gate

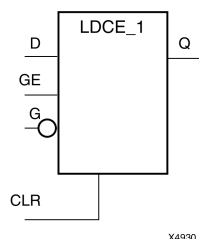

### Introduction

This design element is a transparent data latch with asynchronous clear, gate enable, and inverted gate. When the asynchronous clear input (CLR) is High, it overrides the other inputs and resets the data (Q) output Low. (Q) reflects the data (D) input while the gate (G) input and (CLR) are Low and gate enable (GE) is High. The data on the (D) input during the Low-to-High gate transition is stored in the latch. The data on the (Q) output remains unchanged as long as (G) remains High or (GE) remains Low.

This latch is asynchronously cleared, outputs Low, when power is applied. For FPGA devices, power-on conditions are simulated when global set/reset (GSR) is active. GSR defaults to active-High but can be inverted by adding an inverter in front of the GSR input of the appropriate *STARTUP\_architecture* symbol.

### Logic Table

Inputs				Outputs
CLR	GE	G	D	Q
1	X	X	X	0
0	0	X	X	No Change
0	1	0	D	D
0	1	1	X	No Change
0	1	↑	D	D

### Design Entry Method

This design element is only for use in schematics.

### Available Attributes

Attribute	Data Type	Allowed Values	Default	Description
INIT	Binary	0, 1	0	Sets the initial value of Q output after configuration.

### For More Information

See the [Spartan-6 FPGA User Documentation \(User Guides and Data Sheets\)](#).

## LDE

### Primitive: Transparent Data Latch with Gate Enable

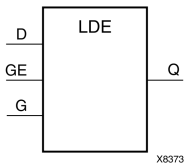

## Introduction

This design element is a transparent data latch with data (D) and gate enable (GE) inputs. Output (Q) reflects the data (D) while the gate (G) input and gate enable (GE) are High. The data on the (D) input during the High-to-Low gate transition is stored in the latch. The data on the (Q) output remains unchanged as long as (G) or (GE) remains Low.

This latch is asynchronously cleared, outputs Low, when power is applied. For FPGA devices, power-on conditions are simulated when global set/reset (GSR) is active. GSR defaults to active-High but can be inverted by adding an inverter in front of the GSR input of the appropriate `STARTUP_architecture` symbol.

## Logic Table

Inputs			Outputs
GE	G	D	Q
0	X	X	No Change
1	1	D	D
1	0	X	No Change
1	↓	D	D

## Design Entry Method

This design element is only for use in schematics.

## Available Attributes

Attribute	Data Type	Allowed Values	Default	Description
INIT	Binary	0, 1	0	Specifies the initial value upon power-up or the assertion of GSR for the (Q) port.

## For More Information

See the [Spartan-6 FPGA User Documentation \(User Guides and Data Sheets\)](#).

## LDE\_1

### Primitive: Transparent Data Latch with Gate Enable and Inverted Gate

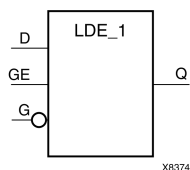

## Introduction

This design element is a transparent data latch with data (D), gate enable (GE), and inverted gate (G). Output (Q) reflects the data (D) while the gate (G) input is Low and gate enable (GE) is High. The data on the (D) input during the Low-to-High gate transition is stored in the latch. The data on the (Q) output remains unchanged as long as (G) is High or (GE) is Low.

This latch is asynchronously cleared, outputs Low, when power is applied. For FPGA devices, power-on conditions are simulated when global set/reset (GSR) is active. GSR defaults to active-High but can be inverted by adding an inverter in front of the GSR input of the appropriate `STARTUP_architecture` symbol.

## Logic Table

Inputs			Outputs
GE	G	D	Q
0	X	X	No Change
1	0	D	D
1	1	X	No Change
1	↑	D	D

## Design Entry Method

This design element is only for use in schematics.

## Available Attributes

Attribute	Data Type	Allowed Values	Default	Description
INIT	Binary	0, 1	0	Specifies the initial value upon power-up or the assertion of GSR for the (Q) port.

## For More Information

See the [Spartan-6 FPGA User Documentation \(User Guides and Data Sheets\)](#).



# LDP

## Primitive: Transparent Data Latch with Asynchronous Preset

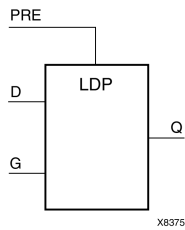

## Introduction

This design element is a transparent data latch with asynchronous preset (PRE). When PRE is High it overrides the other inputs and presets the data (Q) output High. Q reflects the data (D) input while gate (G) input is High and PRE is Low. The data on the (D) input during the High-to-Low gate transition is stored in the latch. The data on the Q output remains unchanged as long as G remains Low.

The latch is asynchronously preset, output High, when power is applied. For FPGA devices, power-on conditions are simulated when global set/reset (GSR) is active. GSR defaults to active-High but can be inverted by adding an inverter in front of the GSR input of the appropriate STARTUP\_architecture symbol.

## Logic Table

Inputs			Outputs
PRE	G	D	Q
1	X	X	1
0	1	0	0
0	1	1	1
0	0	X	No Change
0	↓	D	D

## Design Entry Method

This design element is only for use in schematics.

## Available Attributes

Attribute	Data Type	Allowed Values	Default	Description
INIT	Binary	0, 1	1	Specifies the initial value upon power-up or the assertion of GSR for the Q port.

## For More Information

See the [Spartan-6 FPGA User Documentation \(User Guides and Data Sheets\)](#).

## LDP\_1

### Primitive: Transparent Data Latch with Asynchronous Preset and Inverted Gate

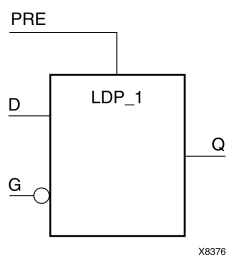

## Introduction

This design element is a transparent data latch with asynchronous preset (PRE) and inverted gate (G). When the (PRE) input is High, it overrides the other inputs and presets the data (Q) output High. (Q) reflects the data (D) input while gate (G) input and (PRE) are Low. The data on the (D) input during the Low-to-High gate transition is stored in the latch. The data on the (Q) output remains unchanged as long as (G) remains High.

The latch is asynchronously preset, output High, when power is applied. For FPGA devices, power-on conditions are simulated when global set/reset (GSR) is active. GSR defaults to active-High but can be inverted by adding an inverter in front of the GSR input of the appropriate *STARTUP\_architecture* symbol.

## Logic Table

Inputs			Outputs
PRE	G	D	Q
1	X	X	1
0	0	D	D
0	1	X	No Change
0	↑	D	D

## Design Entry Method

This design element is only for use in schematics.

## Available Attributes

Attribute	Data Type	Allowed Values	Default	Description
INIT	Binary	0, 1	1	Specifies the initial value upon power-up or the assertion of GSR for the (Q) port.

## For More Information

See the [Spartan-6 FPGA User Documentation \(User Guides and Data Sheets\)](#).

## LDPE

### Primitive: Transparent Data Latch with Asynchronous Preset and Gate Enable

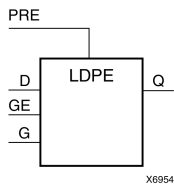

## Introduction

This design element is a transparent data latch with asynchronous preset and gate enable. When the asynchronous preset (PRE) is High, it overrides the other input and presets the data (Q) output High. Q reflects the data (D) input while the gate (G) input and gate enable (GE) are High. The data on the (D) input during the High-to-Low gate transition is stored in the latch. The data on the (Q) output remains unchanged as long as (G) or (GE) remains Low.

The latch is asynchronously preset, output High, when power is applied. For FPGA devices, power-on conditions are simulated when global set/reset (GSR) is active. GSR defaults to active-High but can be inverted by adding an inverter in front of the GSR input of the appropriate *STARTUP\_architecture* symbol.

## Logic Table

Inputs				Outputs
PRE	GE	G	D	Q
1	X	X	X	1
0	0	X	X	No Change
0	1	1	D	D
0	1	0	X	No Change
0	1	↓	D	D

## Design Entry Method

This design element can be used in schematics.

## Available Attributes

Attribute	Data Type	Allowed Values	Default	Description
INIT	Binary	0, 1	1	Specifies the initial value upon power-up or the assertion of GSR for the (Q) port.

## For More Information

See the [Spartan-6 FPGA User Documentation \(User Guides and Data Sheets\)](#).

## LDPE\_1

### Primitive: Transparent Data Latch with Asynchronous Preset, Gate Enable, and Inverted Gate

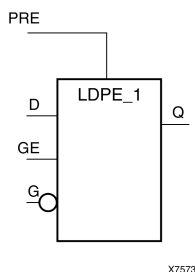

## Introduction

This design element is a transparent data latch with asynchronous preset, gate enable, and inverted gate. When the asynchronous preset (PRE) is High, it overrides the other input and presets the data (Q) output High. (Q) reflects the data (D) input while the gate (G) and (PRE) are Low and gate enable (GE) is High. The data on the (D) input during the Low-to-High gate transition is stored in the latch. The data on the (Q) output remains unchanged as long as (G) remains High or (GE) remains Low.

The latch is asynchronously preset, output High, when power is applied. For FPGA devices, power-on conditions are simulated when global set/reset (GSR) is active. GSR defaults to active-High but can be inverted by adding an inverter in front of the GSR input of the appropriate `STARTUP_architecture` symbol.

## Logic Table

Inputs				Outputs
PRE	GE	G	D	Q
1	X	X	X	1
0	0	X	X	No Change
0	1	0	D	D
0	1	1	X	No Change
0	1	↑	D	D

## Design Entry Method

This design element is only for use in schematics.

## Available Attributes

Attribute	Data Type	Allowed Values	Default	Description
INIT	Binary	0, 1	1	Specifies the initial value upon power-up or the assertion of GSR for the (Q) port.

## For More Information

See the [Spartan-6 FPGA User Documentation \(User Guides and Data Sheets\)](#).

## LUT1

### Macro: 1-Bit Look-Up Table with General Output

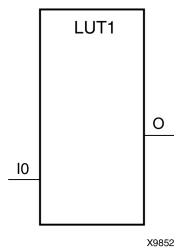

## Introduction

This design element is a 1-bit look-up table (LUT) with general output (O).

An INIT attribute with an appropriate number of hexadecimal digits for the number of inputs must be attached to the LUT to specify its function. This element provides a look-up table version of a buffer or inverter. These elements are the basic building blocks. Two LUTs are available in each CLB slice; four LUTs are available in each CLB. Multiple variants of LUTs accommodate additional types of outputs that can be used by different timing models for more accurate pre-layout timing estimation.

The INIT parameter for the FPGA LUT primitive is what gives the LUT its logical value. By default, this value is zero, thus driving the output to a zero regardless of the input values (acting as a ground). However, in most cases a new INIT value must be determined in order to specify the logic function for the LUT primitive. There are at least two methods by which the LUT value can be determined:

**The Logic Table Method** -A common method to determine the desired INIT value for a LUT is using a logic table. To do so, simply create a binary logic table of all possible inputs, specify the desired logic value of the output and then create the INIT string from those output values.

**The Equation Method** -Another method to determine the LUT value is to define parameters for each input to the LUT that correspond to their listed truth value and use those to build the logic equation you are after. This method is easier to understand once you have grasped the concept and is more self-documenting than the above method. However, this method does require the code to first specify the appropriate parameters.

## Logic Table

Inputs	Outputs
<b>I0</b>	<b>O</b>
0	INIT[0]
1	INIT[1]
INIT = Binary number assigned to the INIT attribute	

## Design Entry Method

This design element can be used in schematics.

## Available Attributes

Attribute	Data Type	Allowed Values	Default	Description
INIT	Hexadecimal	Any 2-Bit Value	All zeros	Initializes look-up tables.

## For More Information

See the [Spartan-6 FPGA User Documentation \(User Guides and Data Sheets\)](#).

## LUT1\_D

### Macro: 1-Bit Look-Up Table with Dual Output

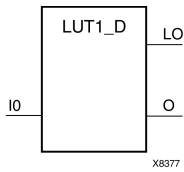

## Introduction

This design element is a 1-bit look-up table (LUT) with two functionally identical outputs, O and LO. It provides a look-up table version of a buffer or inverter.

The O output is a general interconnect. The LO output is used to connect to another input within the same CLB slice and to the fast connect buffer. A mandatory INIT attribute, with an appropriate number of hexadecimal digits for the number of inputs, must be attached to the LUT to specify its function.

The INIT parameter for the FPGA LUT primitive is what gives the LUT its logical value. By default, this value is zero, thus driving the output to a zero regardless of the input values (acting as a ground). However, in most cases a new INIT value must be determined in order to specify the logic function for the LUT primitive. There are at least two methods by which the LUT value can be determined:

- **The Logic Table Method** -A common method to determine the desired INIT value for a LUT is using a logic table. To do so, simply create a binary logic table of all possible inputs, specify the desired logic value of the output and then create the INIT string from those output values.
- **The Equation Method** -Another method to determine the LUT value is to define parameters for each input to the LUT that correspond to their listed truth value and use those to build the logic equation. This method is easier to understand once you have grasped the concept and is more self-documenting than the above method. However, this method does require the code to first specify the appropriate parameters.

## Logic Table

Inputs	Outputs	
I0	O	LO
0	INIT[0]	INIT[0]
1	INIT[1]	INIT[1]

INIT = Binary number assigned to the INIT attribute

## Design Entry Method

This design element can be used in schematics.

## Available Attributes

Attribute	Data Type	Allowed Values	Default	Description
INIT	Hexadecimal	Any 2-Bit Value	All zeros	Initializes look-up tables.

## For More Information

See the [Spartan-6 FPGA User Documentation \(User Guides and Data Sheets\)](#).

## LUT1\_L

### Macro: 1-Bit Look-Up Table with Local Output

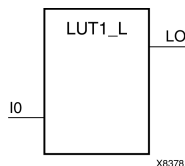

## Introduction

This design element is a 1-bit look-up table (LUT) with a local output (LO) that is used to connect to another output within the same CLB slice and to the fast connect buffer. It provides a look-up table version of a buffer or inverter.

A mandatory INIT attribute, with an appropriate number of hexadecimal digits for the number of inputs, must be attached to the LUT to specify its function.

The INIT parameter for the FPGA LUT primitive is what gives the LUT its logical value. By default, this value is zero, thus driving the output to a zero regardless of the input values (acting as a ground). However, in most cases a new INIT value must be determined in order to specify the logic function for the LUT primitive. There are at least two methods by which the LUT value can be determined:

**The Logic Table Method** -A common method to determine the desired INIT value for a LUT is using a logic table. To do so, simply create a binary logic table of all possible inputs, specify the desired logic value of the output and then create the INIT string from those output values.

**The Equation Method** -Another method to determine the LUT value is to define parameters for each input to the LUT that correspond to their listed truth value and use those to build the logic equation you are after. This method is easier to understand once you have grasped the concept and is more self-documenting than the above method. However, this method does require the code to first specify the appropriate parameters.

## Logic Table

Inputs	Outputs
I0	LO
0	INIT[0]
1	INIT[1]
INIT = Binary number assigned to the INIT attribute	

## Design Entry Method

This design element can be used in schematics.

## Available Attributes

Attribute	Data Type	Allowed Values	Default	Description
INIT	Hexadecimal	Any 2-Bit Value	All zeros	Initializes look-up tables.

## For More Information

See the [Spartan-6 FPGA User Documentation \(User Guides and Data Sheets\)](#).



# LUT2

## Macro: 2-Bit Look-Up Table with General Output

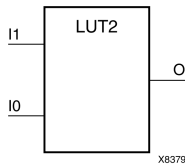

### Introduction

This design element is a 2-bit look-up table (LUT) with general output (O).

An INIT attribute with an appropriate number of hexadecimal digits for the number of inputs must be attached to the LUT to specify its function. This element provides a look-up table version of a buffer or inverter. These elements are the basic building blocks. Two LUTs are available in each CLB slice; four LUTs are available in each CLB. Multiple variants of LUTs accommodate additional types of outputs that can be used by different timing models for more accurate pre-layout timing estimation.

The INIT parameter for the FPGA LUT primitive is what gives the LUT its logical value. By default, this value is zero, thus driving the output to a zero regardless of the input values (acting as a ground). However, in most cases a new INIT value must be determined in order to specify the logic function for the LUT primitive. There are at least two methods by which the LUT value can be determined:

**The Logic Table Method** -A common method to determine the desired INIT value for a LUT is using a logic table. To do so, simply create a binary logic table of all possible inputs, specify the desired logic value of the output and then create the INIT string from those output values.

**The Equation Method** -Another method to determine the LUT value is to define parameters for each input to the LUT that correspond to their listed truth value and use those to build the logic equation you are after. This method is easier to understand once you have grasped the concept and is more self-documenting than the above method. However, this method does require the code to first specify the appropriate parameters.

### Logic Table

Inputs		Outputs
I1	I0	O
0	0	INIT[0]
0	1	INIT[1]
1	0	INIT[2]
1	1	INIT[3]

INIT = Binary equivalent of the hexadecimal number assigned to the INIT attribute

### Design Entry Method

This design element can be used in schematics.

### Available Attributes

Attribute	Data Type	Allowed Values	Default	Description
INIT	Hexadecimal	Any 4-Bit Value	All zeros	Initializes look-up tables.

## For More Information

See the [Spartan-6 FPGA User Documentation \(User Guides and Data Sheets\)](#).

## LUT2\_D

### Macro: 2-Bit Look-Up Table with Dual Output

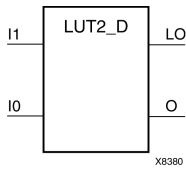

## Introduction

This design element is a 2-bit look-up table (LUT) with two functionally identical outputs, O and LO.

The O output is a general interconnect. The LO output is used to connect to another input within the same CLB slice and to the fast connect buffer. A mandatory INIT attribute, with an appropriate number of hexadecimal digits for the number of inputs, must be attached to the LUT to specify its function.

The INIT parameter for the FPGA LUT primitive is what gives the LUT its logical value. By default, this value is zero, thus driving the output to a zero regardless of the input values (acting as a ground). However, in most cases a new INIT value must be determined in order to specify the logic function for the LUT primitive. There are at least two methods by which the LUT value can be determined:

- **The Logic Table Method** -A common method to determine the desired INIT value for a LUT is using a logic table. To do so, simply create a binary logic table of all possible inputs, specify the desired logic value of the output and then create the INIT string from those output values.
- **The Equation Method** -Another method to determine the LUT value is to define parameters for each input to the LUT that correspond to their listed truth value and use those to build the logic equation. This method is easier to understand once you have grasped the concept and is more self-documenting than the above method. However, this method does require the code to first specify the appropriate parameters.

## Logic Table

Inputs		Outputs	
I1	I0	O	LO
0	0	INIT[0]	INIT[0]
0	1	INIT[1]	INIT[1]
1	0	INIT[2]	INIT[2]
1	1	INIT[3]	INIT[3]

INIT = Binary equivalent of the hexadecimal number assigned to the INIT attribute

## Design Entry Method

This design element can be used in schematics.

## Available Attributes

Attribute	Data Type	Allowed Values	Default	Description
INIT	Hexadecimal	Any 4-Bit Value	All zeros	Initializes look-up tables.

## For More Information

See the [Spartan-6 FPGA User Documentation \(User Guides and Data Sheets\)](#).

## LUT2\_L

### Macro: 2-Bit Look-Up Table with Local Output

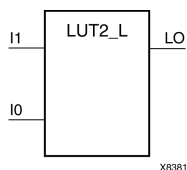

## Introduction

This design element is a 2-bit look-up table (LUT) with a local output (LO) that is used to connect to another output within the same CLB slice and to the fast connect buffer. It provides a look-up table version of a buffer or inverter.

A mandatory INIT attribute, with an appropriate number of hexadecimal digits for the number of inputs, must be attached to the LUT to specify its function.

The INIT parameter for the FPGA LUT primitive is what gives the LUT its logical value. By default, this value is zero, thus driving the output to a zero regardless of the input values (acting as a ground). However, in most cases a new INIT value must be determined in order to specify the logic function for the LUT primitive. There are at least two methods by which the LUT value can be determined:

**The Logic Table Method** -A common method to determine the desired INIT value for a LUT is using a logic table. To do so, simply create a binary logic table of all possible inputs, specify the desired logic value of the output and then create the INIT string from those output values.

**The Equation Method** -Another method to determine the LUT value is to define parameters for each input to the LUT that correspond to their listed truth value and use those to build the logic equation you are after. This method is easier to understand once you have grasped the concept and is more self-documenting than the above method. However, this method does require the code to first specify the appropriate parameters.

## Logic Table

Inputs		Outputs
I1	I0	LO
0	0	INIT[0]
0	1	INIT[1]
1	0	INIT[2]
1	1	INIT[3]

INIT = Binary equivalent of the hexadecimal number assigned to the INIT attribute

## Design Entry Method

This design element can be used in schematics.

## Available Attributes

Attribute	Data Type	Allowed Values	Default	Description
INIT	Hexadecimal	Any 4-Bit Value	All zeros	Initializes look-up tables.

## For More Information

See the [Spartan-6 FPGA User Documentation \(User Guides and Data Sheets\)](#).

## LUT3

### Macro: 3-Bit Look-Up Table with General Output

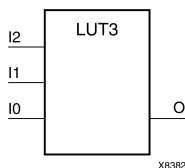

## Introduction

This design element is a 3-bit look-up table (LUT) with general output (O). A mandatory INIT attribute, with an appropriate number of hexadecimal digits for the number of inputs, must be attached to the LUT to specify its function.

An INIT attribute with an appropriate number of hexadecimal digits for the number of inputs must be attached to the LUT to specify its function. This element provides a look-up table version of a buffer or inverter. These elements are the basic building blocks. Two LUTs are available in each CLB slice; four LUTs are available in each CLB. Multiple variants of LUTs accommodate additional types of outputs that can be used by different timing models for more accurate pre-layout timing estimation.

The INIT parameter for the FPGA LUT primitive is what gives the LUT its logical value. By default, this value is zero, thus driving the output to a zero regardless of the input values (acting as a ground). However, in most cases a new INIT value must be determined in order to specify the logic function for the LUT primitive. There are at least two methods by which the LUT value can be determined:

**The Logic Table Method** -A common method to determine the desired INIT value for a LUT is using a logic table. To do so, simply create a binary logic table of all possible inputs, specify the desired logic value of the output and then create the INIT string from those output values.

**The Equation Method** -Another method to determine the LUT value is to define parameters for each input to the LUT that correspond to their listed truth value and use those to build the logic equation you are after. This method is easier to understand once you have grasped the concept and is more self-documenting than the above method. However, this method does require the code to first specify the appropriate parameters.

## Logic Table

Inputs			Outputs
I2	I1	I0	O
0	0	0	INIT[0]
0	0	1	INIT[1]
0	1	0	INIT[2]
0	1	1	INIT[3]
1	0	0	INIT[4]
1	0	1	INIT[5]
1	1	0	INIT[6]
1	1	1	INIT[7]

INIT = Binary equivalent of the hexadecimal number assigned to the INIT attribute

## Design Entry Method

This design element can be used in schematics.

## Available Attributes

Attribute	Data Type	Allowed Values	Default	Description
INIT	Hexadecimal	Any 8-Bit Value	All zeros	Initializes look-up tables.

## For More Information

See the [Spartan-6 FPGA User Documentation \(User Guides and Data Sheets\)](#).

## LUT3\_D

### Macro: 3-Bit Look-Up Table with Dual Output

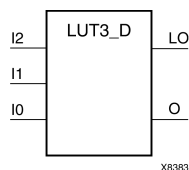

## Introduction

This design element is a 3-bit look-up table (LUT) with two functionally identical outputs, O and LO.

The O output is a general interconnect. The LO output is used to connect to another input within the same CLB slice and to the fast connect buffer. A mandatory INIT attribute, with an appropriate number of hexadecimal digits for the number of inputs, must be attached to the LUT to specify its function.

The INIT parameter for the FPGA LUT primitive is what gives the LUT its logical value. By default, this value is zero, thus driving the output to a zero regardless of the input values (acting as a ground). However, in most cases a new INIT value must be determined in order to specify the logic function for the LUT primitive. There are at least two methods by which the LUT value can be determined:

- **The Logic Table Method** -A common method to determine the desired INIT value for a LUT is using a logic table. To do so, simply create a binary logic table of all possible inputs, specify the desired logic value of the output and then create the INIT string from those output values.
- **The Equation Method** -Another method to determine the LUT value is to define parameters for each input to the LUT that correspond to their listed truth value and use those to build the logic equation. This method is easier to understand once you have grasped the concept and is more self-documenting than the above method. However, this method does require the code to first specify the appropriate parameters.

## Logic Table

Inputs			Outputs	
I2	I1	I0	O	LO
0	0	0	INIT[0]	INIT[0]
0	0	1	INIT[1]	INIT[1]
0	1	0	INIT[2]	INIT[2]
0	1	1	INIT[3]	INIT[3]
1	0	0	INIT[4]	INIT[4]
1	0	1	INIT[5]	INIT[5]
1	1	0	INIT[6]	INIT[6]
1	1	1	INIT[7]	INIT[7]

INIT = Binary equivalent of the hexadecimal number assigned to the INIT attribute

## Design Entry Method

This design element can be used in schematics.



## Available Attributes

Attribute	Data Type	Allowed Values	Default	Description
INIT	Hexadecimal	Any 8-Bit Value	All zeros	Initializes look-up tables.

## For More Information

See the [Spartan-6 FPGA User Documentation \(User Guides and Data Sheets\)](#).

## LUT3\_L

### Macro: 3-Bit Look-Up Table with Local Output

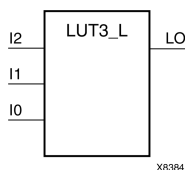

## Introduction

This design element is a 3-bit look-up table (LUT) with a local output (LO) that is used to connect to another output within the same CLB slice and to the fast connect buffer. It provides a look-up table version of a buffer or inverter.

A mandatory INIT attribute, with an appropriate number of hexadecimal digits for the number of inputs, must be attached to the LUT to specify its function.

The INIT parameter for the FPGA LUT primitive is what gives the LUT its logical value. By default, this value is zero, thus driving the output to a zero regardless of the input values (acting as a ground). However, in most cases a new INIT value must be determined in order to specify the logic function for the LUT primitive. There are at least two methods by which the LUT value can be determined:

**The Logic Table Method** -A common method to determine the desired INIT value for a LUT is using a logic table. To do so, simply create a binary logic table of all possible inputs, specify the desired logic value of the output and then create the INIT string from those output values.

**The Equation Method** -Another method to determine the LUT value is to define parameters for each input to the LUT that correspond to their listed truth value and use those to build the logic equation you are after. This method is easier to understand once you have grasped the concept and is more self-documenting than the above method. However, this method does require the code to first specify the appropriate parameters.

## Logic Table

Inputs			Outputs
I2	I1	I0	LO
0	0	0	INIT[0]
0	0	1	INIT[1]
0	1	0	INIT[2]
0	1	1	INIT[3]
1	0	0	INIT[4]
1	0	1	INIT[5]
1	1	0	INIT[6]
1	1	1	INIT[7]

INIT = Binary equivalent of the hexadecimal number assigned to the INIT attribute

## Design Entry Method

This design element can be used in schematics.

## Available Attributes

Attribute	Data Type	Allowed Values	Default	Description
INIT	Hexadecimal	Any 8-Bit Value	All zeros	Initializes look-up tables.

## For More Information

See the [Spartan-6 FPGA User Documentation \(User Guides and Data Sheets\)](#).

## LUT4

### Macro: 4-Bit Look-Up-Table with General Output

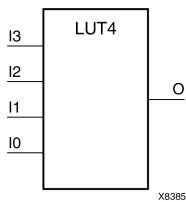

## Introduction

This design element is a 4-bit look-up table (LUT) with general output (O).

An INIT attribute with an appropriate number of hexadecimal digits for the number of inputs must be attached to the LUT to specify its function. This element provides a look-up table version of a buffer or inverter. These elements are the basic building blocks. Two LUTs are available in each CLB slice; four LUTs are available in each CLB. Multiple variants of LUTs accommodate additional types of outputs that can be used by different timing models for more accurate pre-layout timing estimation.

The INIT parameter for the FPGA LUT primitive is what gives the LUT its logical value. By default, this value is zero, thus driving the output to a zero regardless of the input values (acting as a ground). However, in most cases a new INIT value must be determined in order to specify the logic function for the LUT primitive. There are at least two methods by which the LUT value can be determined:

**The Logic Table Method** -A common method to determine the desired INIT value for a LUT is using a logic table. To do so, simply create a binary logic table of all possible inputs, specify the desired logic value of the output and then create the INIT string from those output values.

**The Equation Method** -Another method to determine the LUT value is to define parameters for each input to the LUT that correspond to their listed truth value and use those to build the logic equation you are after. This method is easier to understand once you have grasped the concept and is more self-documenting than the above method. However, this method does require the code to first specify the appropriate parameters.

## Logic Table

Inputs				Outputs
I3	I2	I1	I0	O
0	0	0	0	INIT[0]
0	0	0	1	INIT[1]
0	0	1	0	INIT[2]
0	0	1	1	INIT[3]
0	1	0	0	INIT[4]
0	1	0	1	INIT[5]
0	1	1	0	INIT[6]
0	1	1	1	INIT[7]
1	0	0	0	INIT[8]
1	0	0	1	INIT[9]
1	0	1	0	INIT[10]
1	0	1	1	INIT[11]

Inputs				Outputs
I3	I2	I1	I0	O
1	1	0	0	INIT[12]
1	1	0	1	INIT[13]
1	1	1	0	INIT[14]
1	1	1	1	INIT[15]

INIT = Binary equivalent of the hexadecimal number assigned to the INIT attribute

## Design Entry Method

This design element can be used in schematics.

## Available Attributes

Attribute	Data Type	Allowed Values	Default	Description
INIT	Hexadecimal	Any 16-Bit Value	All zeros	Initializes look-up tables.

## For More Information

See the [Spartan-6 FPGA User Documentation \(User Guides and Data Sheets\)](#).

## LUT4\_D

### Macro: 4-Bit Look-Up Table with Dual Output

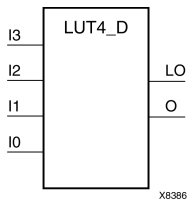

## Introduction

This design element is a 4-bit look-up table (LUT) with two functionally identical outputs, O and LO

The O output is a general interconnect. The LO output is used to connect to another input within the same CLB slice and to the fast connect buffer. A mandatory INIT attribute, with an appropriate number of hexadecimal digits for the number of inputs, must be attached to the LUT to specify its function.

The INIT parameter for the FPGA LUT primitive is what gives the LUT its logical value. By default, this value is zero, thus driving the output to a zero regardless of the input values (acting as a ground). However, in most cases a new INIT value must be determined in order to specify the logic function for the LUT primitive. There are at least two methods by which the LUT value can be determined:

- **The Logic Table Method** -A common method to determine the desired INIT value for a LUT is using a logic table. To do so, simply create a binary logic table of all possible inputs, specify the desired logic value of the output and then create the INIT string from those output values.
- **The Equation Method** -Another method to determine the LUT value is to define parameters for each input to the LUT that correspond to their listed truth value and use those to build the logic equation. This method is easier to understand once you have grasped the concept and is more self-documenting than the above method. However, this method does require the code to first specify the appropriate parameters.

## Logic Table

Inputs				Outputs	
I3	I2	I1	I0	O	LO
0	0	0	0	INIT[0]	INIT[0]
0	0	0	1	INIT[1]	INIT[1]
0	0	1	0	INIT[2]	INIT[2]
0	0	1	1	INIT[3]	INIT[3]
0	1	0	0	INIT[4]	INIT[4]
0	1	0	1	INIT[5]	INIT[5]
0	1	1	0	INIT[6]	INIT[6]
0	1	1	1	INIT[7]	INIT[7]
1	0	0	0	INIT[8]	INIT[8]
1	0	0	1	INIT[9]	INIT[9]
1	0	1	0	INIT[10]	INIT[10]
1	0	1	1	INIT[11]	INIT[11]
1	1	0	0	INIT[12]	INIT[12]
1	1	0	1	INIT[13]	INIT[13]

Inputs				Outputs	
I3	I2	I1	I0	O	LO
1	1	1	0	INIT[14]	INIT[14]
1	1	1	1	INIT[15]	INIT[15]

INIT = Binary equivalent of the hexadecimal number assigned to the INIT attribute

## Design Entry Method

This design element can be used in schematics.

## Available Attributes

Attribute	Data Type	Allowed Values	Default	Description
INIT	Hexadecimal	Any 16-Bit Value	All zeros	Initializes look-up tables.

## For More Information

See the [Spartan-6 FPGA User Documentation \(User Guides and Data Sheets\)](#).

## LUT4\_L

### Macro: 4-Bit Look-Up Table with Local Output

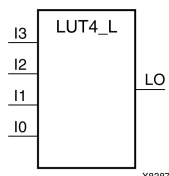

## Introduction

This design element is a 4-bit look-up table (LUT) with a local output (LO) that is used to connect to another output within the same CLB slice and to the fast connect buffer. It provides a look-up table version of a buffer or inverter.

A mandatory INIT attribute, with an appropriate number of hexadecimal digits for the number of inputs, must be attached to the LUT to specify its function.

The INIT parameter for the FPGA LUT primitive is what gives the LUT its logical value. By default, this value is zero, thus driving the output to a zero regardless of the input values (acting as a ground). However, in most cases a new INIT value must be determined in order to specify the logic function for the LUT primitive. There are at least two methods by which the LUT value can be determined:

**The Logic Table Method** -A common method to determine the desired INIT value for a LUT is using a logic table. To do so, simply create a binary logic table of all possible inputs, specify the desired logic value of the output and then create the INIT string from those output values.

**The Equation Method** -Another method to determine the LUT value is to define parameters for each input to the LUT that correspond to their listed truth value and use those to build the logic equation you are after. This method is easier to understand once you have grasped the concept and more self-documenting than the above method. However, this method does require the code to first specify the appropriate parameters.

## Logic Table

Inputs				Outputs
I3	I2	I1	I0	LO
0	0	0	0	INIT[0]
0	0	0	1	INIT[1]
0	0	1	0	INIT[2]
0	0	1	1	INIT[3]
0	1	0	0	INIT[4]
0	1	0	1	INIT[5]
0	1	1	0	INIT[6]
0	1	1	1	INIT[7]
1	0	0	0	INIT[8]
1	0	0	1	INIT[9]
1	0	1	0	INIT[10]
1	0	1	1	INIT[11]
1	1	0	0	INIT[12]



Inputs				Outputs
I3	I2	I1	I0	LO
1	1	0	1	INIT[13]
1	1	1	0	INIT[14]
1	1	1	1	INIT[15]

INIT = Binary equivalent of the hexadecimal number assigned to the INIT attribute

## Design Entry Method

This design element can be used in schematics.

## Available Attributes

Attribute	Data Type	Allowed Values	Default	Description
INIT	Hexadecimal	Any 16-Bit Value	All zeros	Initializes look-up tables.

## For More Information

See the [Spartan-6 FPGA User Documentation \(User Guides and Data Sheets\)](#).

## LUT5

### Primitive: 5-Input Lookup Table with General Output

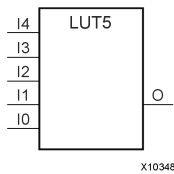

## Introduction

This design element is a 5-input, 1-output look-up table (LUT) that can either act as an asynchronous 32-bit ROM (with 5-bit addressing) or implement any 5-input logic function. LUTs are the basic logic building blocks and are used to implement most logic functions of the design. One LUT5 is packed into a LUT6 within a slice, or two LUT5s can be packed into a single LUT6 with some restrictions. The functionality of the LUT5, LUT5\_L and LUT5\_D is the same. However, the LUT5\_L and LUT5\_D allow the additional specification to connect the LUT5 output signal to an internal slice or CLB connection using the LO output. The LUT5\_L specifies that the only connections from the LUT5 will be within a slice or CLB, while the LUT5\_D allows the specification to connect the output of the LUT to both inter-slice/CLB logic and external logic as well. The LUT5 does not state any specific output connections and should be used in all cases except where internal slice or CLB signal connections must be implicitly specified.

An INIT attribute consisting of a 32-bit hexadecimal value must be specified to indicate the LUTs logical function. The INIT value is calculated by assigning a 1 to the corresponding INIT bit value when the associated inputs are applied. For instance, a Verilog INIT value of 32'h80000000 (X"80000000" for VHDL) makes the output zero unless all of the inputs are one (a 5-input AND gate). A Verilog INIT value of 32'hffffffe (X"FFFFFFFE" for VHDL) makes the output one unless all zeros are on the inputs (a 5-input OR gate).

The INIT parameter for the FPGA LUT primitive is what gives the LUT its logical value. By default, this value is zero, thus driving the output to a zero regardless of the input values (acting as a ground). However, in most cases a new INIT value must be determined in order to specify the logic function for the LUT primitive. There are at least two methods by which the LUT value can be determined:

**The Logic Table Method** -A common method to determine the desired INIT value for a LUT is using a logic table. To do so, simply create a binary logic table of all possible inputs, specify the desired logic value of the output and then create the INIT string from those output values.

**The Equation Method** -Another method to determine the LUT value is to define parameters for each input to the LUT that correspond to their listed truth value and use those to build the logic equation you are after. This method is easier to understand once you have grasped the concept and is more self-documenting than the above method. However, this method does require the code to first specify the appropriate parameters.

## Logic Table

Inputs					Outputs
I4	I3	I2	I1	I0	LO
0	0	0	0	0	INIT[0]
0	0	0	0	1	INIT[1]
0	0	0	1	0	INIT[2]
0	0	0	1	1	INIT[3]
0	0	1	0	0	INIT[4]
0	0	1	0	1	INIT[5]
0	0	1	1	0	INIT[6]

Inputs					Outputs
I4	I3	I2	I1	I0	LO
0	0	1	1	1	INIT[7]
0	1	0	0	0	INIT[8]
0	1	0	0	1	INIT[9]
0	1	0	1	0	INIT[10]
0	1	0	1	1	INIT[11]
0	1	1	0	0	INIT[12]
0	1	1	0	1	INIT[13]
0	1	1	1	0	INIT[14]
0	1	1	1	1	INIT[15]
1	0	0	0	0	INIT[16]
1	0	0	0	1	INIT[17]
1	0	0	1	0	INIT[18]
1	0	0	1	1	INIT[19]
1	0	1	0	0	INIT[20]
1	0	1	0	1	INIT[21]
1	0	1	1	0	INIT[22]
1	0	1	1	1	INIT[23]
1	1	0	0	0	INIT[24]
1	1	0	0	1	INIT[25]
1	1	0	1	0	INIT[26]
1	1	0	1	1	INIT[27]
1	1	1	0	0	INIT[28]
1	1	1	0	1	INIT[29]
1	1	1	1	0	INIT[30]
1	1	1	1	1	INIT[31]

INIT = Binary equivalent of the hexadecimal number assigned to the INIT attribute

### Port Description

Name	Direction	Width	Function
O	Output	1	5-LUT output
I0, I1, I2, I3, I4	Input	1	LUT inputs

### Design Entry Method

This design element can be used in schematics.

## Available Attributes

Attribute	Data Type	Allowed Values	Default	Description
INIT	Hexadecimal	Any 32-Bit Value	All zeros	Specifies the logic value for the look-up tables.

## For More Information

- See the [Spartan-6 FPGA Configurable Logic Block User Guide \(UG384\)](#).
- See the [Spartan-6 FPGA Data Sheet: DC and Switching Characteristics \(DS162\)](#).

# LUT5\_D

## Primitive: 5-Input Lookup Table with General and Local Outputs

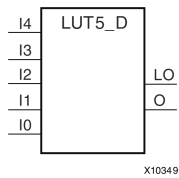

### Introduction

This design element is a 5-input, 1-output look-up table (LUT) that can either act as an asynchronous 32-bit ROM (with 5-bit addressing) or implement any 5-input logic function. LUTs are the basic logic building blocks and are used to implement most logic functions of the design. One LUT5 will be packed into a LUT6 within a slice, or two LUT5s can be packed into a single LUT6 with some restrictions. The functionality of the LUT5, LUT5\_L and LUT5\_D is the same. However, the LUT5\_L and LUT5\_D allow the additional specification to connect the LUT5 output signal to an internal slice or CLB connection using the LO output. The LUT5\_L specifies that the only connections from the LUT5 will be within a slice or CLB, while the LUT5\_D allows the specification to connect the output of the LUT to both inter-slice/CLB logic and external logic. The LUT5 does not state any specific output connections and should be used in all cases except where internal slice or CLB signal connections must be implicitly specified.

An INIT attribute consisting of a 32-bit hexadecimal value must be specified to indicate the LUTs logical function. The INIT value is calculated by assigning a 1 to the corresponding INIT bit value when the associated inputs are applied. For instance, a Verilog INIT value of 32'h80000000 (X"80000000" for VHDL) will make the output zero unless all of the inputs are one (a 5-input AND gate). A Verilog INIT value of 32'hfffffffe (X"FFFFFFFE" for VHDL) will make the output one unless all zeros are on the inputs (a 5-input OR gate).

The INIT parameter for the FPGA LUT primitive is what gives the LUT its logical value. By default, this value is zero, thus driving the output to a zero regardless of the input values (acting as a ground). However, in most cases a new INIT value must be determined in order to specify the logic function for the LUT primitive. There are at least two methods by which the LUT value can be determined:

- **The Logic Table Method** -A common method to determine the desired INIT value for a LUT is using a logic table. To do so, simply create a binary logic table of all possible inputs, specify the desired logic value of the output and then create the INIT string from those output values.
- **The Equation Method** -Another method to determine the LUT value is to define parameters for each input to the LUT that correspond to their listed truth value and use those to build the logic equation. This method is easier to understand once you have grasped the concept and is more self-documenting than the above method. However, this method does require the code to first specify the appropriate parameters.

### Logic Table

Inputs					Outputs	
I4	I3	I2	I1	I0	O	LO
0	0	0	0	0	INIT[0]	INIT[0]
0	0	0	0	1	INIT[1]	INIT[1]
0	0	0	1	0	INIT[2]	INIT[2]
0	0	0	1	1	INIT[3]	INIT[3]
0	0	1	0	0	INIT[4]	INIT[4]
0	0	1	0	1	INIT[5]	INIT[5]
0	0	1	1	0	INIT[6]	INIT[6]

Inputs					Outputs	
I4	I3	I2	I1	I0	O	LO
0	0	1	1	1	INIT[7]	INIT[7]
0	1	0	0	0	INIT[8]	INIT[8]
0	1	0	0	1	INIT[9]	INIT[9]
0	1	0	1	0	INIT[10]	INIT[10]
0	1	0	1	1	INIT[11]	INIT[11]
0	1	1	0	0	INIT[12]	INIT[12]
0	1	1	0	1	INIT[13]	INIT[13]
0	1	1	1	0	INIT[14]	INIT[14]
0	1	1	1	1	INIT[15]	INIT[15]
1	0	0	0	0	INIT[16]	INIT[16]
1	0	0	0	1	INIT[17]	INIT[17]
1	0	0	1	0	INIT[18]	INIT[18]
1	0	0	1	1	INIT[19]	INIT[19]
1	0	1	0	0	INIT[20]	INIT[20]
1	0	1	0	1	INIT[21]	INIT[21]
1	0	1	1	0	INIT[22]	INIT[22]
1	0	1	1	1	INIT[23]	INIT[23]
1	1	0	0	0	INIT[24]	INIT[24]
1	1	0	0	1	INIT[25]	INIT[25]
1	1	0	1	0	INIT[26]	INIT[26]
1	1	0	1	1	INIT[27]	INIT[27]
1	1	1	0	0	INIT[28]	INIT[28]
1	1	1	0	1	INIT[29]	INIT[29]
1	1	1	1	0	INIT[30]	INIT[30]
1	1	1	1	1	INIT[31]	INIT[31]

INIT = Binary equivalent of the hexadecimal number assigned to the INIT attribute

## Port Description

Name	Direction	Width	Function
O	Output	1	5-LUT output
L0	Output	1	5-LUT output for internal CLB connection
I0, I1, I2, I3, I4	Input	1	LUT inputs

## Design Entry Method

This design element can be used in schematics.

## Available Attributes

Attribute	Data Type	Allowed Values	Default	Description
INIT	Hexadecimal	Any 32-Bit Value	All zeros	Specifies the logic value for the look-up tables.

## For More Information

- See the [Spartan-6 FPGA Configurable Logic Block User Guide \(UG384\)](#).
- See the [Spartan-6 FPGA Data Sheet: DC and Switching Characteristics \(DS162\)](#).

## LUT5\_L

### Primitive: 5-Input Lookup Table with Local Output

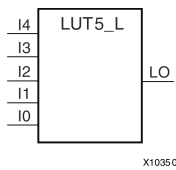

## Introduction

This design element is a 5-input, 1-output look-up table (LUT) that can either act as an asynchronous 32-bit ROM (with 5-bit addressing) or implement any 5-input logic function. LUTs are the basic logic building blocks and are used to implement most logic functions of the design. One LUT5 will be packed into a LUT6 within a slice, or two LUT5s can be packed into a single LUT6 with some restrictions. The functionality of the LUT5, LUT5\_L and LUT5\_D is the same. However, the LUT5\_L and LUT5\_D allow the additional specification to connect the LUT5 output signal to an internal slice or CLB connection using the LO output. The LUT5\_L specifies that the only connections from the LUT5 is within a slice or CLB, while the LUT5\_D allows the specification to connect the output of the LUT to both inter-slice/CLB logic and external logic as well. The LUT5 does not state any specific output connections and should be used in all cases except where internal slice or CLB signal connections must be implicitly specified.

An INIT attribute consisting of a 32-bit hexadecimal value must be specified to indicate the LUTs logical function. The INIT value is calculated by assigning a 1 to the corresponding INIT bit value when the associated inputs are applied. For instance, a Verilog INIT value of 32'h80000000 (X"80000000" for VHDL) makes the output zero unless all of the inputs are one (a 5-input AND gate). A Verilog INIT value of 32'hffffffe (X"FFFFFFFE" for VHDL) makes the output one unless all zeros are on the inputs (a 5-input OR gate).

The INIT parameter for the FPGA LUT primitive is what gives the LUT its logical value. By default, this value is zero, thus driving the output to a zero regardless of the input values (acting as a ground). However, in most cases a new INIT value must be determined in order to specify the logic function for the LUT primitive. There are at least two methods by which the LUT value can be determined:

**The Logic Table Method** -A common method to determine the desired INIT value for a LUT is using a logic table. To do so, simply create a binary truth table of all possible inputs, specify the desired logic value of the output and then create the INIT string from those output values.

**The Equation Method** -Another method to determine the LUT value is to define parameters for each input to the LUT that correspond to their listed logic value and use those to build the logic equation you are after. This method is easier to understand once you have grasped the concept and is more self-documenting than the above method. However, this method does require the code to first specify the appropriate parameters.

## Logic Table

Inputs					Outputs
I4	I3	I2	I1	I0	LO
0	0	0	0	0	INIT[0]
0	0	0	0	1	INIT[1]
0	0	0	1	0	INIT[2]
0	0	0	1	1	INIT[3]
0	0	1	0	0	INIT[4]
0	0	1	0	1	INIT[5]
0	0	1	1	0	INIT[6]



Inputs					Outputs
I4	I3	I2	I1	I0	LO
0	0	1	1	1	INIT[7]
0	1	0	0	0	INIT[8]
0	1	0	0	1	INIT[9]
0	1	0	1	0	INIT[10]
0	1	0	1	1	INIT[11]
0	1	1	0	0	INIT[12]
0	1	1	0	1	INIT[13]
0	1	1	1	0	INIT[14]
0	1	1	1	1	INIT[15]
1	0	0	0	0	INIT[16]
1	0	0	0	1	INIT[17]
1	0	0	1	0	INIT[18]
1	0	0	1	1	INIT[19]
1	0	1	0	0	INIT[20]
1	0	1	0	1	INIT[21]
1	0	1	1	0	INIT[22]
1	0	1	1	1	INIT[23]
1	1	0	0	0	INIT[24]
1	1	0	0	1	INIT[25]
1	1	0	1	0	INIT[26]
1	1	0	1	1	INIT[27]
1	1	1	0	0	INIT[28]
1	1	1	0	1	INIT[29]
1	1	1	1	0	INIT[30]
1	1	1	1	1	INIT[31]

INIT = Binary equivalent of the hexadecimal number assigned to the INIT attribute

### Port Description

Name	Direction	Width	Function
L0	Output	1	6/5-LUT output for internal CLB connection
I0, I1, I2, I3, I4	Input	1	LUT inputs

### Design Entry Method

This design element can be used in schematics.

## Available Attributes

Attribute	Data Type	Allowed Values	Default	Description
INIT	Hexadecimal	Any 32-Bit Value	All zeros	Specifies the logic value for the look-up tables.

## For More Information

- See the [Spartan-6 FPGA Configurable Logic Block User Guide \(UG384\)](#).
- See the [Spartan-6 FPGA Data Sheet: DC and Switching Characteristics \(DS162\)](#).

# LUT6

## Primitive: 6-Input Lookup Table with General Output

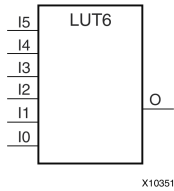

### Introduction

This design element is a 6-input, 1-output look-up table (LUT) that can either act as an asynchronous 64-bit ROM (with 6-bit addressing) or implement any 6-input logic function. LUTs are the basic logic building blocks and are used to implement most logic functions of the design. A LUT6 is mapped to one of the four look-up tables in the slice. The functionality of the LUT6, LUT6\_L and LUT6\_D is the same. However, the LUT6\_L and LUT6\_D allow the additional specification to connect the LUT6 output signal to an internal slice, or CLB connection, using the LO output. The LUT6\_L specifies that the only connections from the LUT6 will be within a slice, or CLB, while the LUT6\_D allows the specification to connect the output of the LUT to both inter-slice/CLB logic and external logic as well. The LUT6 does not state any specific output connections and should be used in all cases except where internal slice or CLB signal connections must be implicitly specified.

An INIT attribute consisting of a 64-bit Hexadecimal value must be specified to indicate the LUTs logical function. The INIT value is calculated by assigning a 1 to corresponding INIT bit value when the associated inputs are applied. For instance, a Verilog INIT value of 64'h8000000000000000 (X"8000000000000000" for VHDL) makes the output zero unless all of the inputs are one (a 6-input AND gate). A Verilog INIT value of 64'hffffffffffff (X"FFFFFFFFFFFFFF" for VHDL) makes the output one unless all zeros are on the inputs (a 6-input OR gate).

The INIT parameter for the FPGA LUT primitive is what gives the LUT its logical value. By default, this value is zero, thus driving the output to a zero regardless of the input values (acting as a ground). However, in most cases a new INIT value must be determined in order to specify the logic function for the LUT primitive. There are at least two methods by which the LUT value can be determined:

**The Logic Table Method** -A common method to determine the desired INIT value for a LUT is using a logic table. To do so, simply create a binary logic table of all possible inputs, specify the desired logic value of the output and then create the INIT string from those output values.

**The Equation Method** -Another method to determine the LUT value is to define parameters for each input to the LUT that correspond to their listed truth value and use those to build the logic equation you are after. This method is easier to understand once you have grasped the concept and is more self-documenting than the above method. However, this method does require the code to first specify the appropriate parameters.

### Logic Table

Inputs						Outputs
I5	I4	I3	I2	I1	I0	O
0	0	0	0	0	0	INIT[0]
0	0	0	0	0	1	INIT[1]
0	0	0	0	1	0	INIT[2]
0	0	0	0	1	1	INIT[3]
0	0	0	1	0	0	INIT[4]
0	0	0	1	0	1	INIT[5]
0	0	0	1	1	0	INIT[6]
0	0	0	1	1	1	INIT[7]

Inputs						Outputs
I5	I4	I3	I2	I1	I0	O
0	0	1	0	0	0	INIT[8]
0	0	1	0	0	1	INIT[9]
0	0	1	0	1	0	INIT[10]
0	0	1	0	1	1	INIT[11]
0	0	1	1	0	0	INIT[12]
0	0	1	1	0	1	INIT[13]
0	0	1	1	1	0	INIT[14]
0	0	1	1	1	1	INIT[15]
0	1	0	0	0	0	INIT[16]
0	1	0	0	0	1	INIT[17]
0	1	0	0	1	0	INIT[18]
0	1	0	0	1	1	INIT[19]
0	1	0	1	0	0	INIT[20]
0	1	0	1	0	1	INIT[21]
0	1	0	1	1	0	INIT[22]
0	1	0	1	1	1	INIT[23]
0	1	1	0	0	0	INIT[24]
0	1	1	0	0	1	INIT[25]
0	1	1	0	1	0	INIT[26]
0	1	1	0	1	1	INIT[27]
0	1	1	1	0	0	INIT[28]
0	1	1	1	0	1	INIT[29]
0	1	1	1	1	0	INIT[30]
0	1	1	1	1	1	INIT[31]
1	0	0	0	0	0	INIT[32]
1	0	0	0	0	1	INIT[33]
1	0	0	0	1	0	INIT[34]
1	0	0	0	1	1	INIT[35]
1	0	0	1	0	0	INIT[36]
1	0	0	1	0	1	INIT[37]
1	0	0	1	1	0	INIT[38]
1	0	0	1	1	1	INIT[39]
1	0	1	0	0	0	INIT[40]
1	0	1	0	0	1	INIT[41]
1	0	1	0	1	0	INIT[42]
1	0	1	0	1	1	INIT[43]
1	0	1	1	0	0	INIT[44]

Inputs						Outputs
I5	I4	I3	I2	I1	I0	O
1	0	1	1	0	1	INIT[45]
1	0	1	1	1	0	INIT[46]
1	0	1	1	1	1	INIT[47]
1	1	0	0	0	0	INIT[48]
1	1	0	0	0	1	INIT[49]
1	1	0	0	1	0	INIT[50]
1	1	0	0	1	1	INIT[51]
1	1	0	1	0	0	INIT[52]
1	1	0	1	0	1	INIT[53]
1	1	0	1	1	0	INIT[54]
1	1	0	1	1	1	INIT[55]
1	1	1	0	0	0	INIT[56]
1	1	1	0	0	1	INIT[57]
1	1	1	0	1	0	INIT[58]
1	1	1	0	1	1	INIT[59]
1	1	1	1	0	0	INIT[60]
1	1	1	1	0	1	INIT[61]
1	1	1	1	1	0	INIT[62]
1	1	1	1	1	1	INIT[63]

INIT = Binary equivalent of the hexadecimal number assigned to the INIT attribute

## Port Description

Name	Direction	Width	Function
O	Output	1	6/5-LUT output
I0, I1, I2, I3, I4, I5	Input	1	LUT inputs

## Design Entry Method

This design element can be used in schematics.

## Available Attributes

Attribute	Data Type	Allowed Values	Default	Description
INIT	Hexadecimal	Any 64-Bit Value	All zeros	Specifies the logic value for the look-up tables.

## For More Information

- See the [Spartan-6 FPGA Configurable Logic Block User Guide \(UG384\)](#).
- See the [Spartan-6 FPGA Data Sheet: DC and Switching Characteristics \(DS162\)](#).

## LUT6\_2

Primitive: Six-input, 2-output, Look-Up Table

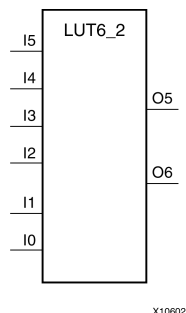

### Introduction

This design element is a 6-input, 2-output look-up table (LUT) that can either act as a dual asynchronous 32-bit ROM (with 5-bit addressing), implement any two 5-input logic functions with shared inputs, or implement a 6-input logic function and a 5-input logic function with shared inputs and shared logic values. LUTs are the basic logic building blocks and are used to implement most logic functions of the design. A LUT6\_2 will be mapped to one of the four look-up tables in the slice.

An INIT attribute consisting of a 64-bit hexadecimal value must be specified to indicate the LUTs logical function. The INIT value is calculated by assigning a 1 to corresponding INIT bit value when the associated inputs are applied. For instance, a Verilog INIT value of 64'hffffffffffffe (X"FFFFFFFFFFFFFFFE" for VHDL) makes the O6 output 1 unless all zeros are on the inputs and the O5 output a 1, or unless I[4:0] are all zeroes (a 5-input and 6-input OR gate). The lower half (bits 31:0) of the INIT values apply to the logic function of the O5 output.

The INIT parameter for the FPGA LUT primitive is what gives the LUT its logical value. By default, this value is zero, thus driving the output to a zero regardless of the input values (acting as a ground). However, in most cases a new INIT value must be determined in order to specify the logic function for the LUT primitive. There are at least two methods by which the LUT value can be determined:

- **The Logic Table Method** -A common method to determine the desired INIT value for a LUT is using a logic table. To do so, simply create a binary logic table of all possible inputs, specify the desired logic value of the output and then create the INIT string from those output values.
- **The Equation Method** -Another method to determine the LUT value is to define parameters for each input to the LUT that correspond to their listed truth value and use those to build the logic equation. This method is easier to understand once you have grasped the concept and is more self-documenting than the above method. However, this method does require the code to first specify the appropriate parameters.

### Logic Table

Inputs						Outputs	
I5	I4	I3	I2	I1	I0	O5	O6
0	0	0	0	0	0	INIT[0]	INIT[0]
0	0	0	0	0	1	INIT[1]	INIT[1]
0	0	0	0	1	0	INIT[2]	INIT[2]
0	0	0	0	1	1	INIT[3]	INIT[3]
0	0	0	1	0	0	INIT[4]	INIT[4]
0	0	0	1	0	1	INIT[5]	INIT[5]
0	0	0	1	1	0	INIT[6]	INIT[6]
0	0	0	1	1	1	INIT[7]	INIT[7]

Inputs						Outputs	
0	0	1	0	0	0	INIT[8]	INIT[8]
0	0	1	0	0	1	INIT[9]	INIT[9]
0	0	1	0	1	0	INIT[10]	INIT[10]
0	0	1	0	1	1	INIT[11]	INIT[11]
0	0	1	1	0	0	INIT[12]	INIT[12]
0	0	1	1	0	1	INIT[13]	INIT[13]
0	0	1	1	1	0	INIT[14]	INIT[14]
0	0	1	1	1	1	INIT[15]	INIT[15]
0	1	0	0	0	0	INIT[16]	INIT[16]
0	1	0	0	0	1	INIT[17]	INIT[17]
0	1	0	0	1	0	INIT[18]	INIT[18]
0	1	0	0	1	1	INIT[19]	INIT[19]
0	1	0	1	0	0	INIT[20]	INIT[20]
0	1	0	1	0	1	INIT[21]	INIT[21]
0	1	0	1	1	0	INIT[22]	INIT[22]
0	1	0	1	1	1	INIT[23]	INIT[23]
0	1	1	0	0	0	INIT[24]	INIT[24]
0	1	1	0	0	1	INIT[25]	INIT[25]
0	1	1	0	1	0	INIT[26]	INIT[26]
0	1	1	0	1	1	INIT[27]	INIT[27]
0	1	1	1	0	0	INIT[28]	INIT[28]
0	1	1	1	0	1	INIT[29]	INIT[29]
0	1	1	1	1	0	INIT[30]	INIT[30]
0	1	1	1	1	1	INIT[31]	INIT[31]
1	0	0	0	0	0	INIT[0]	INIT[32]
1	0	0	0	0	1	INIT[1]	INIT[33]
1	0	0	0	1	0	INIT[2]	INIT[34]
1	0	0	0	1	1	INIT[3]	INIT[35]
1	0	0	1	0	0	INIT[4]	INIT[36]
1	0	0	1	0	1	INIT[5]	INIT[37]
1	0	0	1	1	0	INIT[6]	INIT[38]
1	0	0	1	1	1	INIT[7]	INIT[39]
1	0	1	0	0	0	INIT[8]	INIT[40]
1	0	1	0	0	1	INIT[9]	INIT[41]
1	0	1	0	1	0	INIT[10]	INIT[42]
1	0	1	0	1	1	INIT[11]	INIT[43]
1	0	1	1	0	0	INIT[12]	INIT[44]
1	0	1	1	0	1	INIT[13]	INIT[45]
1	0	1	1	1	0	INIT[14]	INIT[46]

Inputs						Outputs	
1	0	1	1	1	1	INIT[15]	INIT[47]
1	1	0	0	0	0	INIT[16]	INIT[48]
1	1	0	0	0	1	INIT[17]	INIT[49]
1	1	0	0	1	0	INIT[18]	INIT[50]
1	1	0	0	1	1	INIT[19]	INIT[51]
1	1	0	1	0	0	INIT[20]	INIT[52]
1	1	0	1	0	1	INIT[21]	INIT[53]
1	1	0	1	1	0	INIT[22]	INIT[54]
1	1	0	1	1	1	INIT[23]	INIT[55]
1	1	1	0	0	0	INIT[24]	INIT[56]
1	1	1	0	0	1	INIT[25]	INIT[57]
1	1	1	0	1	0	INIT[26]	INIT[58]
1	1	1	0	1	1	INIT[27]	INIT[59]
1	1	1	1	0	0	INIT[28]	INIT[60]
1	1	1	1	0	1	INIT[29]	INIT[61]
1	1	1	1	1	0	INIT[30]	INIT[62]
1	1	1	1	1	1	INIT[31]	INIT[63]

INIT = Binary equivalent of the hexadecimal number assigned to the INIT attribute

## Port Descriptions

Port	Direction	Width	Function
O6	Output	1	6/5-LUT output
O5	Output	1	5-LUT output
I0, I1, I2, I3, I4, I5	Input	1	LUT inputs

## Design Entry Method

This design element can be used in schematics.

## Available Attributes

Attribute	Data Type	Allowed Values	Default	Description
INIT	Hexadecimal	Any 64-Bit Value	All zeros	Specifies the LUT5/6 output function.

## For More Information

- See the [Spartan-6 FPGA Configurable Logic Block User Guide \(UG384\)](#).
- See the [Spartan-6 FPGA Data Sheet: DC and Switching Characteristics \(DS162\)](#).



# LUT6\_D

## Primitive: 6-Input Lookup Table with General and Local Outputs

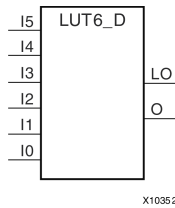

### Introduction

This design element is a six-input, one-output look-up table (LUT) that can either act as an asynchronous 64-bit ROM (with 6-bit addressing) or implement any 6-input logic function. LUTs are the basic logic building blocks and are used to implement most logic functions of the design. A LUT6 is mapped to one of the four look-up tables in the slice. The functionality of the LUT6, LUT6\_L and LUT6\_D is the same. However, the LUT6\_L and LUT6\_D allow the additional specification to connect the LUT6 output signal to an internal slice, or CLB connection, using the LO output. The LUT6\_L specifies that the only connections from the LUT6 will be within a slice, or CLB, while the LUT6\_D allows the specification to connect the output of the LUT to both inter-slice/CLB logic and external logic as well. The LUT6 does not state any specific output connections and should be used in all cases except where internal slice or CLB signal connections must be implicitly specified.

An INIT attribute consisting of a 64-bit Hexadecimal value must be specified to indicate the LUTs logical function. The INIT value is calculated by assigning a 1 to corresponding INIT bit value when the associated inputs are applied. For instance, a Verilog INIT value of 64'h8000000000000000 (X"8000000000000000" for VHDL) makes the output zero unless all of the inputs are one (a 6-input AND gate). A Verilog INIT value of 64'hffffffffffff (X"FFFFFFFFFFFFFF" for VHDL) makes the output one unless all zeros are on the inputs (a 6-input OR gate).

The INIT parameter for the FPGA LUT primitive is what gives the LUT its logical value. By default, this value is zero, thus driving the output to a zero regardless of the input values (acting as a ground). However, in most cases a new INIT value must be determined in order to specify the logic function for the LUT primitive. There are at least two methods by which the LUT value can be determined:

**The Logic Table Method** -A common method to determine the desired INIT value for a LUT is using a logic table. To do so, simply create a binary logic table of all possible inputs, specify the desired logic value of the output and then create the INIT string from those output values.

**The Equation Method** -Another method to determine the LUT value is to define parameters for each input to the LUT that correspond to their listed truth value and use those to build the logic equation you are after. This method is easier to understand once you have grasped the concept and more is self-documenting than the above method. However, this method does require the code to first specify the appropriate parameters.

### Logic Table

Inputs						Outputs	
I5	I4	I3	I2	I1	I0	O	LO
0	0	0	0	0	0	INIT[0]	INIT[0]
0	0	0	0	0	1	INIT[1]	INIT[1]
0	0	0	0	1	0	INIT[2]	INIT[2]
0	0	0	0	1	1	INIT[3]	INIT[3]
0	0	0	1	0	0	INIT[4]	INIT[4]
0	0	0	1	0	1	INIT[5]	INIT[5]
0	0	0	1	1	0	INIT[6]	INIT[6]

Inputs						Outputs	
I5	I4	I3	I2	I1	I0	O	LO
0	0	0	1	1	1	INIT[7]	INIT[7]
0	0	1	0	0	0	INIT[8]	INIT[8]
0	0	1	0	0	1	INIT[9]	INIT[9]
0	0	1	0	1	0	INIT[10]	INIT[10]
0	0	1	0	1	1	INIT[11]	INIT[11]
0	0	1	1	0	0	INIT[12]	INIT[12]
0	0	1	1	0	1	INIT[13]	INIT[13]
0	0	1	1	1	0	INIT[14]	INIT[14]
0	0	1	1	1	1	INIT[15]	INIT[15]
0	1	0	0	0	0	INIT[16]	INIT[16]
0	1	0	0	0	1	INIT[17]	INIT[17]
0	1	0	0	1	0	INIT[18]	INIT[18]
0	1	0	0	1	1	INIT[19]	INIT[19]
0	1	0	1	0	0	INIT[20]	INIT[20]
0	1	0	1	0	1	INIT[21]	INIT[21]
0	1	0	1	1	0	INIT[22]	INIT[22]
0	1	0	1	1	1	INIT[23]	INIT[23]
0	1	1	0	0	0	INIT[24]	INIT[24]
0	1	1	0	0	1	INIT[25]	INIT[25]
0	1	1	0	1	0	INIT[26]	INIT[26]
0	1	1	0	1	1	INIT[27]	INIT[27]
0	1	1	1	0	0	INIT[28]	INIT[28]
0	1	1	1	0	1	INIT[29]	INIT[29]
0	1	1	1	1	0	INIT[30]	INIT[30]
0	1	1	1	1	1	INIT[31]	INIT[31]
1	0	0	0	0	0	INIT[32]	INIT[32]
1	0	0	0	0	1	INIT[33]	INIT[33]
1	0	0	0	1	0	INIT[34]	INIT[34]
1	0	0	0	1	1	INIT[35]	INIT[35]
1	0	0	1	0	0	INIT[36]	INIT[36]
1	0	0	1	0	1	INIT[37]	INIT[37]
1	0	0	1	1	0	INIT[38]	INIT[38]
1	0	0	1	1	1	INIT[39]	INIT[39]
1	0	1	0	0	0	INIT[40]	INIT[40]
1	0	1	0	0	1	INIT[41]	INIT[41]
1	0	1	0	1	0	INIT[42]	INIT[42]
1	0	1	0	1	1	INIT[43]	INIT[43]

Inputs						Outputs	
I5	I4	I3	I2	I1	I0	O	LO
1	0	1	1	0	0	INIT[44]	INIT[44]
1	0	1	1	0	1	INIT[45]	INIT[45]
1	0	1	1	1	0	INIT[46]	INIT[46]
1	0	1	1	1	1	INIT[47]	INIT[47]
1	1	0	0	0	0	INIT[48]	INIT[48]
1	1	0	0	0	1	INIT[49]	INIT[49]
1	1	0	0	1	0	INIT[50]	INIT[50]
1	1	0	0	1	1	INIT[51]	INIT[51]
1	1	0	1	0	0	INIT[52]	INIT[52]
1	1	0	1	0	1	INIT[53]	INIT[53]
1	1	0	1	1	0	INIT[54]	INIT[54]
1	1	0	1	1	1	INIT[55]	INIT[55]
1	1	1	0	0	0	INIT[56]	INIT[56]
1	1	1	0	0	1	INIT[57]	INIT[57]
1	1	1	0	1	0	INIT[58]	INIT[58]
1	1	1	0	1	1	INIT[59]	INIT[59]
1	1	1	1	0	0	INIT[60]	INIT[60]
1	1	1	1	0	1	INIT[61]	INIT[61]
1	1	1	1	1	0	INIT[62]	INIT[62]
1	1	1	1	1	1	INIT[63]	INIT[63]

INIT = Binary equivalent of the hexadecimal number assigned to the INIT attribute

### Port Description

Name	Direction	Width	Function
O6	Output	1	6/5-LUT output
O5	Output	1	5-LUT output
I0, I1, I2, I3, I4, I5	Input	1	LUT inputs

### Design Entry Method

This design element can be used in schematics.

### Available Attributes

Attribute	Data Type	Allowed Values	Default	Description
INIT	Hexadecimal	Any 64-Bit Value	All zeros	Specifies the logic value for the look-up tables.

## For More Information

- See the [Spartan-6 FPGA Configurable Logic Block User Guide \(UG384\)](#).
- See the [Spartan-6 FPGA Data Sheet: DC and Switching Characteristics \(DS162\)](#).

# LUT6\_L

## Primitive: 6-Input Lookup Table with Local Output

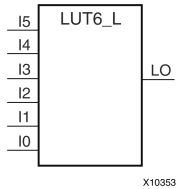

### Introduction

This design element is a 6-input, 1-output look-up table (LUT) that can either act as an asynchronous 64-bit ROM (with 6-bit addressing) or implement any 6-input logic function. LUTs are the basic logic building blocks and are used to implement most logic functions of the design. A LUT6 is mapped to one of the four look-up tables in the slice. The functionality of the LUT6, LUT6\_L and LUT6\_D is the same. However, the LUT6\_L and LUT6\_D allow the additional specification to connect the LUT6 output signal to an internal slice, or CLB connection, using the LO output. The LUT6\_L specifies that the only connections from the LUT6 are within a slice, or CLB, while the LUT6\_D allows the specification to connect the output of the LUT to both inter-slice/CLB logic and external logic as well. The LUT6 does not state any specific output connections and should be used in all cases except where internal slice or CLB signal connections must be implicitly specified.

An INIT attribute consisting of a 64-bit hexadecimal value must be specified to indicate the LUT's logical function. The INIT value is calculated by assigning a 1 to the corresponding INIT bit value when the associated inputs are applied. For instance, a Verilog INIT value of 64'h8000000000000000 (X"8000000000000000" for VHDL) will make the output zero unless all of the inputs are one (a 6-input AND gate). A Verilog INIT value of 64'hfffffffffffffe (X"FFFFFFFFFFFFFFFE" for VHDL) will make the output one unless all zeros are on the inputs (a 6-input OR gate).

The INIT parameter for the FPGA LUT primitive is what gives the LUT its logical value. By default, this value is zero, thus driving the output to a zero regardless of the input values (acting as a ground). However, in most cases a new INIT value must be determined in order to specify the logic function for the LUT primitive. There are at least two methods by which the LUT value can be determined:

**The Logic Table Method** -A common method to determine the desired INIT value for a LUT is using a logic table. To do so, simply create a binary truth table of all possible inputs, specify the desired logic value of the output and then create the INIT string from those output values.

**The Equation Method** -Another method to determine the LUT value is to define parameters for each input to the LUT that correspond to their listed truth value and use those to build the logic equation you are after. This method is easier to understand once you have grasped the concept and is more self-documenting than the above method. However, this method does require the code to first specify the appropriate parameters.

### Logic Table

Inputs						Outputs
I5	I4	I3	I2	I1	I0	LO
0	0	0	0	0	0	INIT[0]
0	0	0	0	0	1	INIT[1]
0	0	0	0	1	0	INIT[2]
0	0	0	0	1	1	INIT[3]
0	0	0	1	0	0	INIT[4]
0	0	0	1	0	1	INIT[5]
0	0	0	1	1	0	INIT[6]

Inputs						Outputs
I5	I4	I3	I2	I1	I0	LO
0	0	0	1	1	1	INIT[7]
0	0	1	0	0	0	INIT[8]
0	0	1	0	0	1	INIT[9]
0	0	1	0	1	0	INIT[10]
0	0	1	0	1	1	INIT[11]
0	0	1	1	0	0	INIT[12]
0	0	1	1	0	1	INIT[13]
0	0	1	1	1	0	INIT[14]
0	0	1	1	1	1	INIT[15]
0	1	0	0	0	0	INIT[16]
0	1	0	0	0	1	INIT[17]
0	1	0	0	1	0	INIT[18]
0	1	0	0	1	1	INIT[19]
0	1	0	1	0	0	INIT[20]
0	1	0	1	0	1	INIT[21]
0	1	0	1	1	0	INIT[22]
0	1	0	1	1	1	INIT[23]
0	1	1	0	0	0	INIT[24]
0	1	1	0	0	1	INIT[25]
0	1	1	0	1	0	INIT[26]
0	1	1	0	1	1	INIT[27]
0	1	1	1	0	0	INIT[28]
0	1	1	1	0	1	INIT[29]
0	1	1	1	1	0	INIT[30]
0	1	1	1	1	1	INIT[31]
1	0	0	0	0	0	INIT[32]
1	0	0	0	0	1	INIT[33]
1	0	0	0	1	0	INIT[34]
1	0	0	0	1	1	INIT[35]
1	0	0	1	0	0	INIT[36]
1	0	0	1	0	1	INIT[37]
1	0	0	1	1	0	INIT[38]
1	0	0	1	1	1	INIT[39]
1	0	1	0	0	0	INIT[40]
1	0	1	0	0	1	INIT[41]
1	0	1	0	1	0	INIT[42]
1	0	1	0	1	1	INIT[43]

Inputs						Outputs
I5	I4	I3	I2	I1	I0	LO
1	0	1	1	0	0	INIT[44]
1	0	1	1	0	1	INIT[45]
1	0	1	1	1	0	INIT[46]
1	0	1	1	1	1	INIT[47]
1	1	0	0	0	0	INIT[48]
1	1	0	0	0	1	INIT[49]
1	1	0	0	1	0	INIT[50]
1	1	0	0	1	1	INIT[51]
1	1	0	1	0	0	INIT[52]
1	1	0	1	0	1	INIT[53]
1	1	0	1	1	0	INIT[54]
1	1	0	1	1	1	INIT[55]
1	1	1	0	0	0	INIT[56]
1	1	1	0	0	1	INIT[57]
1	1	1	0	1	0	INIT[58]
1	1	1	0	1	1	INIT[59]
1	1	1	1	0	0	INIT[60]
1	1	1	1	0	1	INIT[61]
1	1	1	1	1	0	INIT[62]
1	1	1	1	1	1	INIT[63]

INIT = Binary equivalent of the hexadecimal number assigned to the INIT attribute

### Port Description

Name	Direction	Width	Function
LO	Output	1	6/5-LUT output or internal CLB connection
I0, I1, I2, I3, I4, I5	Input	1	LUT inputs

### Design Entry Method

This design element can be used in schematics.

### Available Attributes

Attribute	Data Type	Allowed Values	Default	Description
INIT	Hexadecimal	Any 64-Bit Value	All zeros	Specifies the logic value for the look-up tables.

## For More Information

- See the [Spartan-6 FPGA Configurable Logic Block User Guide \(UG384\)](#).
- See the [Spartan-6 FPGA Data Sheet: DC and Switching Characteristics \(DS162\)](#).



# M16\_1E

## Macro: 16-to-1 Multiplexer with Enable

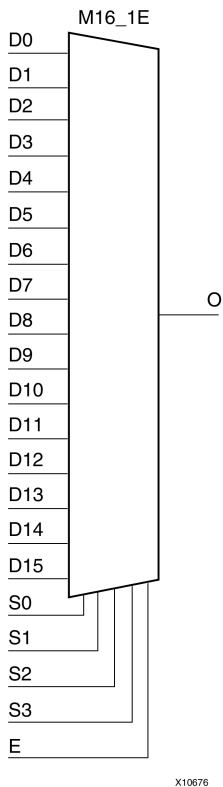

X10676

### Introduction

This design element is a 16-to-1 multiplexer with enable. When the enable input (E) is High, the M16\_1E multiplexer chooses one data bit from 16 sources (D15 : D0) under the control of the select inputs (S3 : S0). The output (O) reflects the state of the selected input as shown in the logic table. When (E) is Low, the output is Low.

### Logic Table

Inputs						Outputs
E	S3	S2	S1	S0	D15-D0	O
0	X	X	X	X	X	0
1	0	0	0	0	D0	D0
1	0	0	0	1	D1	D1
1	0	0	1	0	D2	D2
1	0	0	1	1	D3	D3
.	.	.	.	.	.	.
.	.	.	.	.	.	.
.	.	.	.	.	.	.
1	1	1	0	0	D12	D12
1	1	1	0	1	D13	D13

Inputs						Outputs
E	S3	S2	S1	S0	D15-D0	O
1	1	1	1	0	D14	D14
1	1	1	1	1	D15	D15

## Design Entry Method

This design element is only for use in schematics.

## For More Information

See the [Spartan-6 FPGA User Documentation \(User Guides and Data Sheets\)](#).

## M2\_1

### Macro: 2-to-1 Multiplexer

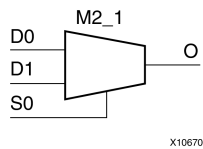

## Introduction

This design element chooses one data bit from two sources (D1 or D0) under the control of the select input (S0). The output (O) reflects the state of the selected data input. When Low, S0 selects D0 and when High, S0 selects D1.

## Logic Table

Inputs			Outputs
S0	D1	D0	O
1	D1	X	D1
0	X	D0	D0

## Design Entry Method

This design element is only for use in schematics.

## For More Information

See the [Spartan-6 FPGA User Documentation \(User Guides and Data Sheets\)](#).

## M2\_1B1

### Macro: 2-to-1 Multiplexer with D0 Inverted

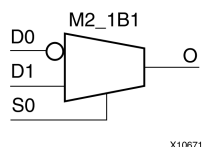

## Introduction

This design element chooses one data bit from two sources (D1 or D0) under the control of select input (S0). When S0 is Low, the output (O) reflects the inverted value of (D0). When S0 is High, (O) reflects the state of D1.

## Logic Table

Inputs			Outputs
S0	D1	D0	O
1	1	X	1
1	0	X	0
0	X	1	0
0	X	0	1

## Design Entry Method

This design element is only for use in schematics.

## For More Information

See the [Spartan-6 FPGA User Documentation \(User Guides and Data Sheets\)](#).

## M2\_1B2

Macro: 2-to-1 Multiplexer with D0 and D1 Inverted

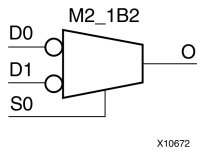

### Introduction

This design element chooses one data bit from two sources (D1 or D0) under the control of select input (S0). When S0 is Low, the output (O) reflects the inverted value of D0. When S0 is High, O reflects the inverted value of D1.

### Logic Table

Inputs			Outputs
S0	D1	D0	O
1	1	X	0
1	0	X	1
0	X	1	0
0	X	0	1

### Design Entry Method

This design element is only for use in schematics.

### For More Information

See the [Spartan-6 FPGA User Documentation \(User Guides and Data Sheets\)](#).

## M2\_1E

### Macro: 2-to-1 Multiplexer with Enable

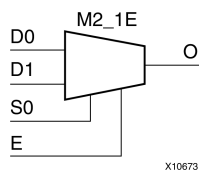

## Introduction

This design element is a 2-to-1 multiplexer with enable. When the enable input (E) is High, the M2\_1E chooses one data bit from two sources (D1 or D0) under the control of select input (S0). When Low, S0 selects D0 and when High, S0 selects D1. When (E) is Low, the output is Low.

## Logic Table

Inputs				Outputs
E	S0	D1	D0	O
0	X	X	X	0
1	0	X	1	1
1	0	X	0	0
1	1	1	X	1
1	1	0	X	0

## Design Entry Method

This design element is only for use in schematics.

## For More Information

See the [Spartan-6 FPGA User Documentation \(User Guides and Data Sheets\)](#).

## M4\_1E

### Macro: 4-to-1 Multiplexer with Enable

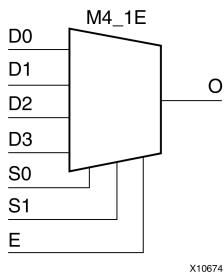

### Introduction

This design element is a 4-to-1 multiplexer with enable. When the enable input (E) is High, the M4\_1E multiplexer chooses one data bit from four sources (D3, D2, D1, or D0) under the control of the select inputs (S1 : S0). The output (O) reflects the state of the selected input as shown in the logic table. When (E) is Low, the output is Low.

### Logic Table

Inputs							Outputs
E	S1	S0	D0	D1	D2	D3	O
0	X	X	X	X	X	X	0
1	0	0	D0	X	X	X	D0
1	0	1	X	D1	X	X	D1
1	1	0	X	X	D2	X	D2
1	1	1	X	X	X	D3	D3

### Design Entry Method

This design element is only for use in schematics.

### For More Information

See the [Spartan-6 FPGA User Documentation \(User Guides and Data Sheets\)](#).

## M8\_1E

### Macro: 8-to-1 Multiplexer with Enable

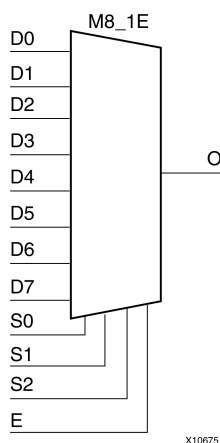

## Introduction

This design element is an 8-to-1 multiplexer with enable. When the enable input (E) is High, the M8\_1E multiplexer chooses one data bit from eight sources (D7 : D0) under the control of the select inputs (S2 : S0). The output (O) reflects the state of the selected input as shown in the logic table. When (E) is Low, the output is Low.

## Logic Table

Inputs					Outputs
E	S2	S1	S0	D7-D0	O
0	X	X	X	X	0
1	0	0	0	D0	D0
1	0	0	1	D1	D1
1	0	1	0	D2	D2
1	0	1	1	D3	D3
1	1	0	0	D4	D4
1	1	0	1	D5	D5
1	1	1	0	D6	D6
1	1	1	1	D7	D7

## Design Entry Method

This design element is only for use in schematics.

## For More Information

See the [Spartan-6 FPGA User Documentation \(User Guides and Data Sheets\)](#).



## MULT\_AND

### Primitive: Fast Multiplier AND

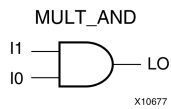

## Introduction

The design element is an AND component located within the slice where the two inputs are shared with the 4-input LUT and the output drives into the carry logic. This added logic is especially useful for building fast and smaller multipliers. However, it can be used for other purposes as well. The I1 and I0 inputs must be connected to the I1 and I0 inputs of the associated LUT. The LO output must be connected to the DI input of the associated MUXCY, MUXCY\_D, or MUXCY\_L.

## Logic Table

Inputs		Outputs
I1	I0	LO
0	0	0
0	1	0
1	0	0
1	1	1

## Design Entry Method

This design element can be used in schematics.

## For More Information

See the [Spartan-6 FPGA User Documentation \(User Guides and Data Sheets\)](#).

## MULT18X18SIO

Primitive: 18 x 18 Cascadable Signed Multiplier with Optional Input and Output Registers, Clock Enable, and Synchronous Reset

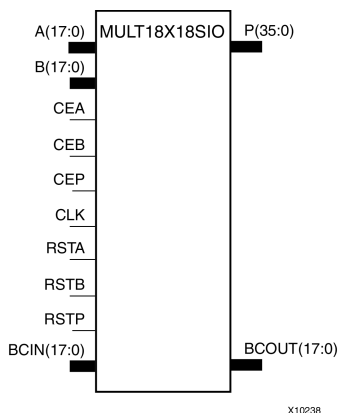

### Introduction

This design element is a 36-bit output, 18x18-bit input dedicated signed multiplier. This component can perform asynchronous multiplication operations when the attributes AREG, BREG and PREG are all set to 0. Alternatively, synchronous multiplication operations of different latency and performance characteristics can be performed when any combination of those attributes is set to 1. When using the multiplier in synchronous operation, the MULT18X18SIO features active high clock enables for each set of register banks in the multiplier, CEA, CEB and CEP, as well as synchronous resets, RSTA, RSTB, and RSTP. Multiple MULT18X18SIOs can be cascaded to create larger multiplication functions using the BCIN and BCOUT ports in combination with the B\_INPUT attribute.

### Design Entry Method

This design element can be used in schematics.

### Available Attributes

Attribute	Data Type	Allowed Values	Default	Descriptions
AREG	Integer	0, 1	1	Specifies the use of the input registers on the A port. A zero disables the use of the register; a one enables the register.
BREG	Integer	0, 1	1	Specifies the use of the input registers on the B port. A zero disables the use of the register; a one enables the register.
B_INPUT	String	"DIRECT" or "CASCADE"	"DIRECT"	Specifies whether the B port is connected to the general FPGA fabric, "DIRECT" or is connected to the BCOUT port of another MULT18X18SIO.
PREG	Integer	0, 1	1	Specifies the use of the output registers of the multiplier. A zero disables the use of the register; a one enables the register.

### For More Information

See the [Spartan-6 FPGA User Documentation \(User Guides and Data Sheets\)](#).

## MUXCY

### Primitive: 2-to-1 Multiplexer for Carry Logic with General Output

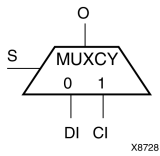

## Introduction

The direct input (DI) of a slice is connected to the (DI) input of the MUXCY. The carry in (CI) input of an LC is connected to the CI input of the MUXCY. The select input (S) of the MUXCY is driven by the output of the look-up table (LUT) and configured as a MUX function. The carry out (O) of the MUXCY reflects the state of the selected input and implements the carry out function of each LC. When Low, S selects DI; when High, S selects CI.

The variants MUXCY\_D and MUXCY\_L provide additional types of outputs that can be used by different timing models for more accurate pre-layout timing estimation.

## Logic Table

Inputs			Outputs
S	DI	CI	O
0	1	X	1
0	0	X	0
1	X	1	1
1	X	0	0

## Design Entry Method

This design element can be used in schematics.

## For More Information

See the [Spartan-6 FPGA User Documentation \(User Guides and Data Sheets\)](#).

## MUXCY\_D

### Primitive: 2-to-1 Multiplexer for Carry Logic with Dual Output

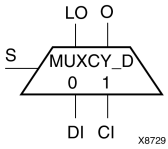

## Introduction

This design element implements a 1-bit, high-speed carry propagate function. One such function can be implemented per logic cell (LC), for a total of 4-bits per configurable logic block (CLB). The direct input (DI) of an LC is connected to the DI input of the MUXCY\_D. The carry in (CI) input of an LC is connected to the CI input of the MUXCY\_D. The select input (S) of the MUX is driven by the output of the look-up table (LUT) and configured as an XOR function. The carry out (O and LO) of the MUXCY\_D reflects the state of the selected input and implements the carry out function of each LC. When Low, S selects DI; when High, S selects CI.

Outputs O and LO are functionally identical. The O output is a general interconnect. See also MUXCY and MUXCY\_L.

## Logic Table

Inputs			Outputs	
S	DI	CI	O	LO
0	1	X	1	1
0	0	X	0	0
1	X	1	1	1
1	X	0	0	0

## Design Entry Method

This design element can be used in schematics.

## For More Information

See the [Spartan-6 FPGA User Documentation \(User Guides and Data Sheets\)](#).

## MUXCY\_L

### Primitive: 2-to-1 Multiplexer for Carry Logic with Local Output

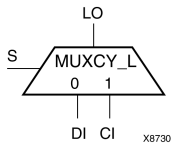

## Introduction

This design element implements a 1-bit high-speed carry propagate function. One such function is implemented per logic cell (LC), for a total of 4-bits per configurable logic block (CLB). The direct input (DI) of an LC is connected to the DI input of the MUXCY\_L. The carry in (CI) input of an LC is connected to the CI input of the MUXCY\_L. The select input (S) of the MUXCY\_L is driven by the output of the look-up table (LUT) and configured as an XOR function. The carry out (LO) of the MUXCY\_L reflects the state of the selected input and implements the carry out function of each (LC). When Low, (S) selects DI; when High, (S) selects (CI).

See also MUXCY and MUXCY\_D.

## Logic Table

Inputs			Outputs
S	DI	CI	LO
0	1	X	1
0	0	X	0
1	X	1	1
1	X	0	0

## Design Entry Method

This design element can be used in schematics.

## For More Information

See the [Spartan-6 FPGA User Documentation \(User Guides and Data Sheets\)](#).

## MUXF5

### Primitive: 2-to-1 Look-Up Table Multiplexer with General Output

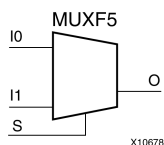

## Introduction

This design element is a two input multiplexer for creating a function-of-5 look-up table or a 4-to-1 multiplexer when connected to LUT4 look-up tables. The local outputs (LO) from two LUT4 look-up tables are connected to the I0 and I1 inputs of the MUXF5. The S input is driven from any internal net. When Low, S selects I0. When High, S selects I1.

The O output is a general interconnect.

The variants MUXF5\_D and MUXF5\_L provide additional types of outputs that can be used by different timing models for more accurate pre-layout timing estimation.

## Logic Table

Inputs			Outputs
S	I0	I1	O
0	1	X	1
0	0	X	0
1	X	1	1
1	X	0	0

## Design Entry Method

This design element can be used in schematics.

## For More Information

See the [Spartan-6 FPGA User Documentation \(User Guides and Data Sheets\)](#).

## MUXF5\_D

### Primitive: 2-to-1 Look-Up Table Multiplexer with Dual Output

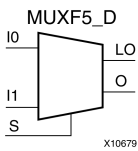

## Introduction

This design element is a two input multiplexer for creating a function-of-5 look-up table or a 4-to-1 multiplexer when connected to LUT4 look-up tables. The local outputs (LO) from two LUT4 look-up tables are connected to the I0 and I1 inputs of the MUXF5. The S input is driven from any internal net. When Low, S selects I0. When High, S selects I1.

Outputs O and LO are functionally identical. The O output is a general interconnect. The LO output connects to other inputs in the same CLB slice.

See also MUXF5 and MUXF5\_L.

## Logic Table

Inputs			Outputs	
S	I0	I1	O	LO
0	1	X	1	1
0	0	X	0	0
1	X	1	1	1
1	X	0	0	0

## Design Entry Method

This design element can be used in schematics.

## For More Information

See the [Spartan-6 FPGA User Documentation \(User Guides and Data Sheets\)](#).

## MUXF5\_L

Primitive: 2-to-1 Look-Up Table Multiplexer with Local Output

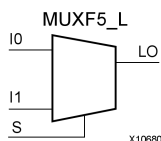

### Introduction

This design element is a two input multiplexer for creating a function-of-5 look-up table or a 4-to-1 multiplexer when connected to LUT4 look-up tables. The local outputs (LO) from two LUT4 look-up tables are connected to the I0 and I1 inputs of the MUXF5. The S input is driven from any internal net. When Low, S selects I0. When High, S selects I1.

The LO output connects to other inputs in the same CLB slice.

See also MUXF5 and MUXF5\_D.

### Logic Table

Inputs			Output
S	I0	I1	LO
0	1	X	1
0	0	X	0
1	X	1	1
1	X	0	0

### Design Entry Method

This design element can be used in schematics.

### For More Information

See the [Spartan-6 FPGA User Documentation \(User Guides and Data Sheets\)](#).



## MUXF6

### Primitive: 2-to-1 Look-Up Table Multiplexer with General Output

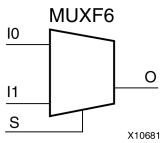

## Introduction

This design element is a two input multiplexer in two slices for creating a function-of-6 look-up table or an 8-to-1 multiplexer in combination with the associated four LUT4 look-up tables and two MUXF5 multiplexers. The local outputs (LO) from two MUXF5 multiplexers in the CLB are connected to the I0 and I1 inputs of the MUXF6. The S input is driven from any internal net. When Low, S selects I0. When High, S selects I1.

The O output is a general interconnect.

The variants MUXF6\_D and MUXF6\_L provide additional types of outputs that can be used by different timing models for more accurate pre-layout timing estimation.

## Logic Table

Inputs			Outputs
S	I0	I1	O
0	1	X	1
0	0	X	0
1	X	1	1
1	X	0	0

## Design Entry Method

This design element can be used in schematics.

## For More Information

See the [Spartan-6 FPGA User Documentation \(User Guides and Data Sheets\)](#).

## MUXF6\_D

### Primitive: 2-to-1 Look-Up Table Multiplexer with Dual Output

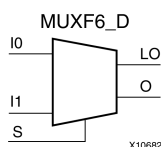

## Introduction

This design element is a two input multiplexer in two slices for creating a function-of-6 look-up table or an 8-to-1 multiplexer in combination with the associated four LUT4 look-up tables and two MUXF5 multiplexers. The local outputs (LO) from two MUXF5 multiplexers in the CLB are connected to the I0 and I1 inputs of the MUXF6. The S input is driven from any internal net. When Low, S selects I0. When High, S selects I1.

Outputs O and LO are functionally identical. The O output is a general interconnect. The LO output connects to other inputs in the same CLB slice.

See also MUXF6 and MUXF6\_L.

## Logic Table

Inputs			Outputs	
S	I0	I1	O	LO
0	1	X	1	1
0	0	X	0	0
1	X	1	1	1
1	X	0	0	0

## Design Entry Method

This design element can be used in schematics.

## For More Information

See the [Spartan-6 FPGA User Documentation \(User Guides and Data Sheets\)](#).

## MUXF6\_L

Primitive: 2-to-1 Look-Up Table Multiplexer with Local Output

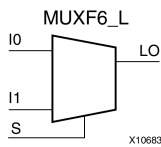

### Introduction

This design element is a two input multiplexer in two slices for creating a function-of-6 look-up table or an 8-to-1 multiplexer in combination with the associated four LUT4 look-up tables and two MUXF5 multiplexers. The local outputs (LO) from two MUXF5 multiplexers in the CLB are connected to the I0 and I1 inputs of the MUXF6. The S input is driven from any internal net. When Low, S selects I0. When High, S selects I1.

The LO output connects to other inputs in the same CLB slice.

See also MUXF6 and MUXF6\_D.

### Logic Table

Inputs			Output
S	I0	I1	LO
0	1	X	1
0	0	X	0
1	X	1	1
1	X	0	0

### Design Entry Method

This design element can be used in schematics.

### For More Information

See the [Spartan-6 FPGA User Documentation \(User Guides and Data Sheets\)](#).

## MUXF7

### Primitive: 2-to-1 Look-Up Table Multiplexer with General Output

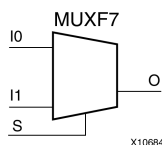

## Introduction

This design element is a two input multiplexer for creating a function-of-7 look-up table or a 16-to-1 multiplexer in combination with two LUT6 look-up tables. Local outputs (LO) of two LUT6 are connected to the I0 and I1 inputs of the MUXF7. The S input is driven from any internal net. When Low, S selects I0. When High, S selects I1.

The O output is a general interconnect.

The variants MUXF7\_D and MUXF7\_L provide additional types of outputs that can be used by different timing models for more accurate pre-layout timing estimation.

## Logic Table

Inputs			Outputs
S	I0	I1	O
0	I0	X	I0
1	X	I1	I1
X	0	0	0
X	1	1	1

## Port Descriptions

Port	Direction	Width	Function
O	Output	1	Output of MUX to general routing
I0	Input	1	Input (tie to MUXF6 LO out)
I1	Input	1	Input (tie to MUXF6 LO out)
S	Input	1	Input select to MUX

## Design Entry Method

This design element can be used in schematics.

## For More Information

- See the [Spartan-6 FPGA Configurable Logic Block User Guide \(UG384\)](#).
- See the [Spartan-6 FPGA Data Sheet: DC and Switching Characteristics \(DS162\)](#).

## MUXF7\_D

### Primitive: 2-to-1 Look-Up Table Multiplexer with Dual Output

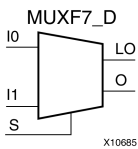

## Introduction

This design element is a two input multiplexer for creating a function-of-7 look-up table or a 16-to-1 multiplexer in combination with two LUT6 look-up tables. Local outputs (LO) of two LUT6 are connected to the I0 and I1 inputs of the MUXF7. The S input is driven from any internal net. When Low, S selects I0. When High, S selects I1.

Outputs O and LO are functionally identical. The O output is a general interconnect. The LO output connects to other inputs in the same CLB slice.

See also MUXF7 and MUXF7\_L.

## Logic Table

Inputs			Outputs	
S	I0	I1	O	LO
0	I0	X	I0	I0
1	X	I1	I1	I1
X	0	0	0	0
X	1	1	1	1

## Port Descriptions

Port	Direction	Width	Function
O	Output	1	Output of MUX to general routing
LO	Output	1	Output of MUX to local routing
I0	Input	1	Input (tie to MUXF6 LO out)
I1	Input	1	Input (tie to MUXF6 LO out)
S	Input	1	Input select to MUX

## Design Entry Method

This design element can be used in schematics.

## For More Information

- See the [Spartan-6 FPGA Configurable Logic Block User Guide \(UG384\)](#).
- See the [Spartan-6 FPGA Data Sheet: DC and Switching Characteristics \(DS162\)](#).

## MUXF7\_L

Primitive: 2-to-1 look-up table Multiplexer with Local Output

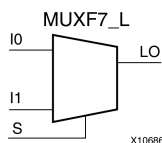

### Introduction

This design element is a two input multiplexer for creating a function-of-7 look-up table or a 16-to-1 multiplexer in combination with two LUT6 look-up tables. Local outputs (LO) of two LUT6 are connected to the I0 and I1 inputs of the MUXF7. The S input is driven from any internal net. When Low, S selects I0. When High, S selects I1.

The LO output connects to other inputs in the same CLB slice.

See also MUXF7 and MUXF7\_D.

### Logic Table

Inputs			Output
S	I0	I1	LO
0	I0	X	I0
1	X	I1	I1
X	0	0	0
X	1	1	1

### Port Descriptions

Port	Direction	Width	Function
LO	Output	1	Output of MUX to local routing
I0	Input	1	Input
I1	Input	1	Input
S	Input	1	Input select to MUX

### Design Entry Method

This design element can be used in schematics.

### For More Information

- See the [Spartan-6 FPGA Configurable Logic Block User Guide \(UG384\)](#).
- See the [Spartan-6 FPGA Data Sheet: DC and Switching Characteristics \(DS162\)](#).

## MUXF8

### Primitive: 2-to-1 Look-Up Table Multiplexer with General Output

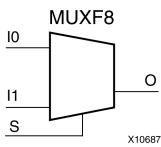

## Introduction

This design element provides a multiplexer function in eight slices for creating a function-of-8 look-up table or a 32-to-1 multiplexer in combination with the associated look-up tables, MUXF5s, MUXF6s, and MUXF7s. Local outputs (LO) of MUXF7 are connected to the I0 and I1 inputs of the MUXF8. The S input is driven from any internal net. When Low, S selects I0. When High, S selects I1.

## Logic Table

Inputs			Outputs
S	I0	I1	O
0	I0	X	I0
1	X	I1	I1
X	0	0	0
X	1	1	1

## Port Descriptions

Port	Direction	Width	Function
O	Output	1	Output of MUX to general routing
I0	Input	1	Input (tie to MUXF7 LO out)
I1	Input	1	Input (tie to MUXF7 LO out)
S	Input	1	Input select to MUX

## Design Entry Method

This design element can be used in schematics.

## For More Information

- See the [Spartan-6 FPGA Configurable Logic Block User Guide \(UG384\)](#).
- See the [Spartan-6 FPGA Data Sheet: DC and Switching Characteristics \(DS162\)](#).

## MUXF8\_D

### Primitive: 2-to-1 Look-Up Table Multiplexer with Dual Output

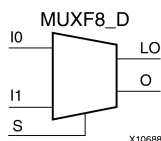

## Introduction

This design element provides a multiplexer function in eight slices for creating a function-of-8 look-up table or a 32-to-1 multiplexer in combination with the associated look-up tables, MUXF5s, MUXF6s, and MUXF7s. Local outputs (LO) of MUXF7 are connected to the I0 and I1 inputs of the MUXF8. The S input is driven from any internal net. When Low, S selects I0. When High, S selects I1.

Outputs O and LO are functionally identical. The O output is a general interconnect. The LO output connects to other inputs in the same CLB slice.

## Logic Table

Inputs			Outputs	
S	I0	I1	O	LO
0	I0	X	I0	I0
1	X	I1	I1	I1
X	0	0	0	0
X	1	1	1	1

## Port Descriptions

Port	Direction	Width	Function
O	Output	1	Output of MUX to general routing
LO	Output	1	Output of MUX to local routing
I0	Input	1	Input (tie to MUXF7 LO out)
I1	Input	1	Input (tie to MUXF7 LO out)
S	Input	1	Input select to MUX

## Design Entry Method

This design element can be used in schematics.

## For More Information

- See the [Spartan-6 FPGA Configurable Logic Block User Guide \(UG384\)](#).
- See the [Spartan-6 FPGA Data Sheet: DC and Switching Characteristics \(DS162\)](#).



# MUXF8\_L

## Primitive: 2-to-1 Look-Up Table Multiplexer with Local Output

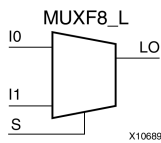

## Introduction

This design element provides a multiplexer function in eight slices for creating a function-of-8 look-up table or a 32-to-1 multiplexer in combination with the associated look-up tables, MUXF5s, MUXF6s, and MUXF7s. Local outputs (LO) of MUXF7 are connected to the I0 and I1 inputs of the MUXF8. The S input is driven from any internal net. When Low, S selects I0. When High, S selects I1.

The LO output connects to other inputs in the same CLB slice.

## Logic Table

Inputs			Output
S	I0	I1	LO
0	I0	X	I0
1	X	I1	I1
X	0	0	0
X	1	1	1

## Port Descriptions

Port	Direction	Width	Function
LO	Output	1	Output of MUX to local routing
I0	Input	1	Input (tie to MUXF7 LO out)
I1	Input	1	Input (tie to MUXF7 LO out)
S	Input	1	Input select to MUX

## Design Entry Method

This design element can be used in schematics.

## For More Information

- See the [Spartan-6 FPGA Configurable Logic Block User Guide \(UG384\)](#).
- See the [Spartan-6 FPGA Data Sheet: DC and Switching Characteristics \(DS162\)](#).

## NAND12

### Macro: 12- Input NAND Gate with Non-Inverted Inputs

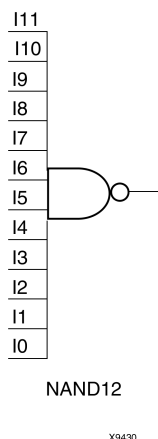

### Introduction

NAND elements implement Negated AND or NOT AND. A High (1) output results when one or more inputs are a Low (0). A Low (0) output results only if all inputs are High (1).

NAND gates of up to five inputs are available in any combination of inverting and non-inverting inputs. NAND gates of six to nine inputs, 12 inputs, and 16 inputs are available with only non-inverting inputs. To invert inputs, use external inverters. Because each input uses a CLB resource, replace gates with unused inputs with gates having the necessary number of inputs.

### Logic Table

Input	Output
I0 ... Iz	0
All inputs are 1	1
Any single input is 0	0

### Design Entry Method

This design element is only for use in schematics.

### For More Information

See the [Spartan-6 FPGA User Documentation \(User Guides and Data Sheets\)](#).

## NAND16

### Macro: 16- Input NAND Gate with Non-Inverted Inputs

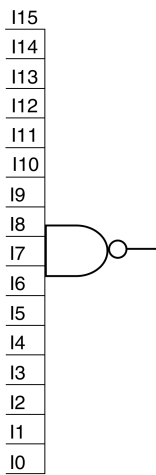

NAND16

X9431

## Introduction

NAND elements implement Negated AND or NOT AND. A High (1) output results when one or more inputs are a Low (0). A Low (0) output results only if all inputs are High (1).

NAND gates of up to five inputs are available in any combination of inverting and non-inverting inputs. NAND gates of six to nine inputs, 12 inputs, and 16 inputs are available with only non-inverting inputs. To invert inputs, use external inverters. Because each input uses a CLB resource, replace gates with unused inputs with gates having the necessary number of inputs.

## Logic Table

Input	Output
I0 ... Iz	O
All inputs are 1	0
Any single input is 0	1

## Design Entry Method

This design element is only for use in schematics.

## For More Information

See the [Spartan-6 FPGA User Documentation \(User Guides and Data Sheets\)](#).

## NAND2

### Primitive: 2-Input NAND Gate with Non-Inverted Inputs

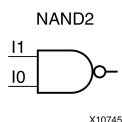

## Introduction

NAND elements implement Negated AND or NOT AND. A High (1) output results when one or more inputs are a Low (0). A Low (0) output results only if all inputs are High (1).

NAND gates of up to five inputs are available in any combination of inverting and non-inverting inputs. NAND gates of six to nine inputs, 12 inputs, and 16 inputs are available with only non-inverting inputs. To invert inputs, use external inverters. Because each input uses a CLB resource, replace gates with unused inputs with gates having the necessary number of inputs.

## Logic Table

Input	Output
I0 ... Iz	O
All inputs are 1	0
Any single input is 0	1

## Design Entry Method

This design element is only for use in schematics.

## For More Information

See the [Spartan-6 FPGA User Documentation \(User Guides and Data Sheets\)](#).

## NAND2B1

### Primitive: 2-Input NAND Gate with 1 Inverted and 1 Non-Inverted Inputs

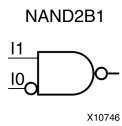

## Introduction

NAND elements implement Negated AND or NOT AND. A High (1) output results when one or more inputs are a Low (0). A Low (0) output results only if all inputs are High (1).

NAND gates of up to five inputs are available in any combination of inverting and non-inverting inputs. NAND gates of six to nine inputs, 12 inputs, and 16 inputs are available with only non-inverting inputs. To invert inputs, use external inverters. Because each input uses a CLB resource, replace gates with unused inputs with gates having the necessary number of inputs.

## Design Entry Method

This design element is only for use in schematics.

## For More Information

See the [Spartan-6 FPGA User Documentation \(User Guides and Data Sheets\)](#).

## NAND2B2

### Primitive: 2-Input NAND Gate with Inverted Inputs

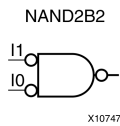

## Introduction

NAND elements implement Negated AND or NOT AND. A High (1) output results when one or more inputs are a Low (0). A Low (0) output results only if all inputs are High (1).

NAND gates of up to five inputs are available in any combination of inverting and non-inverting inputs. NAND gates of six to nine inputs, 12 inputs, and 16 inputs are available with only non-inverting inputs. To invert inputs, use external inverters. Because each input uses a CLB resource, replace gates with unused inputs with gates having the necessary number of inputs.

## Design Entry Method

This design element is only for use in schematics.

## For More Information

See the [Spartan-6 FPGA User Documentation \(User Guides and Data Sheets\)](#).

## NAND3

### Primitive: 3-Input NAND Gate with Non-Inverted Inputs

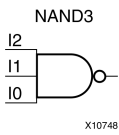

## Introduction

NAND elements implement Negated AND or NOT AND. A High (1) output results when one or more inputs are a Low (0). A Low (0) output results only if all inputs are High (1).

NAND gates of up to five inputs are available in any combination of inverting and non-inverting inputs. NAND gates of six to nine inputs, 12 inputs, and 16 inputs are available with only non-inverting inputs. To invert inputs, use external inverters. Because each input uses a CLB resource, replace gates with unused inputs with gates having the necessary number of inputs.

## Logic Table

Input	Output
I0 ... Iz	0
All inputs are 1	0
Any single input is 0	1

## Design Entry Method

This design element is only for use in schematics.

## For More Information

See the [Spartan-6 FPGA User Documentation \(User Guides and Data Sheets\)](#).

## NAND3B1

### Primitive: 3-Input NAND Gate with 1 Inverted and 2 Non-Inverted Inputs

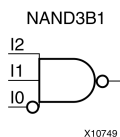

## Introduction

NAND elements implement Negated AND or NOT AND. A High (1) output results when one or more inputs are a Low (0). A Low (0) output results only if all inputs are High (1).

NAND gates of up to five inputs are available in any combination of inverting and non-inverting inputs. NAND gates of six to nine inputs, 12 inputs, and 16 inputs are available with only non-inverting inputs. To invert inputs, use external inverters. Because each input uses a CLB resource, replace gates with unused inputs with gates having the necessary number of inputs.

## Design Entry Method

This design element is only for use in schematics.

## For More Information

See the [Spartan-6 FPGA User Documentation \(User Guides and Data Sheets\)](#).



## NAND3B2

Primitive: 3-Input NAND Gate with 2 Inverted and 1 Non-Inverted Inputs

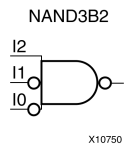

### Introduction

NAND elements implement Negated AND or NOT AND. A High (1) output results when one or more inputs are a Low (0). A Low (0) output results only if all inputs are High (1).

NAND gates of up to five inputs are available in any combination of inverting and non-inverting inputs. NAND gates of six to nine inputs, 12 inputs, and 16 inputs are available with only non-inverting inputs. To invert inputs, use external inverters. Because each input uses a CLB resource, replace gates with unused inputs with gates having the necessary number of inputs.

### Design Entry Method

This design element is only for use in schematics.

### For More Information

See the [Spartan-6 FPGA User Documentation \(User Guides and Data Sheets\)](#).

## NAND3B3

### Primitive: 3-Input NAND Gate with Inverted Inputs

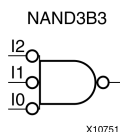

## Introduction

NAND elements implement Negated AND or NOT AND. A High (1) output results when one or more inputs are a Low (0). A Low (0) output results only if all inputs are High (1).

NAND gates of up to five inputs are available in any combination of inverting and non-inverting inputs. NAND gates of six to nine inputs, 12 inputs, and 16 inputs are available with only non-inverting inputs. To invert inputs, use external inverters. Because each input uses a CLB resource, replace gates with unused inputs with gates having the necessary number of inputs.

## Design Entry Method

This design element is only for use in schematics.

## For More Information

See the [Spartan-6 FPGA User Documentation \(User Guides and Data Sheets\)](#).

## NAND4

### Primitive: 4-Input NAND Gate with Non-Inverted Inputs

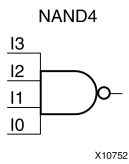

## Introduction

NAND elements implement Negated AND or NOT AND. A High (1) output results when one or more inputs are a Low (0). A Low (0) output results only if all inputs are High (1).

NAND gates of up to five inputs are available in any combination of inverting and non-inverting inputs. NAND gates of six to nine inputs, 12 inputs, and 16 inputs are available with only non-inverting inputs. To invert inputs, use external inverters. Because each input uses a CLB resource, replace gates with unused inputs with gates having the necessary number of inputs.

## Logic Table

Input	Output
I0 ... Iz	0
All inputs are 1	0
Any single input is 0	1

## Design Entry Method

This design element is only for use in schematics.

## For More Information

See the [Spartan-6 FPGA User Documentation \(User Guides and Data Sheets\)](#).

## NAND4B1

Primitive: 4-Input NAND Gate with 1 Inverted and 3 Non-Inverted Inputs

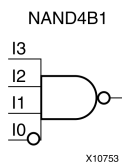

### Introduction

NAND elements implement Negated AND or NOT AND. A High (1) output results when one or more inputs are a Low (0). A Low (0) output results only if all inputs are High (1).

NAND gates of up to five inputs are available in any combination of inverting and non-inverting inputs. NAND gates of six to nine inputs, 12 inputs, and 16 inputs are available with only non-inverting inputs. To invert inputs, use external inverters. Because each input uses a CLB resource, replace gates with unused inputs with gates having the necessary number of inputs.

### Design Entry Method

This design element is only for use in schematics.

### For More Information

See the [Spartan-6 FPGA User Documentation \(User Guides and Data Sheets\)](#).

## NAND4B2

Primitive: 4-Input NAND Gate with 2 Inverted and 2 Non-Inverted Inputs

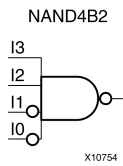

### Introduction

NAND elements implement Negated AND or NOT AND. A High (1) output results when one or more inputs are a Low (0). A Low (0) output results only if all inputs are High (1).

NAND gates of up to five inputs are available in any combination of inverting and non-inverting inputs. NAND gates of six to nine inputs, 12 inputs, and 16 inputs are available with only non-inverting inputs. To invert inputs, use external inverters. Because each input uses a CLB resource, replace gates with unused inputs with gates having the necessary number of inputs.

### Design Entry Method

This design element is only for use in schematics.

### For More Information

See the [Spartan-6 FPGA User Documentation \(User Guides and Data Sheets\)](#).

## NAND4B3

Primitive: 4-Input NAND Gate with 3 Inverted and 1 Non-Inverted Inputs

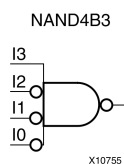

### Introduction

NAND elements implement Negated AND or NOT AND. A High (1) output results when one or more inputs are a Low (0). A Low (0) output results only if all inputs are High (1).

NAND gates of up to five inputs are available in any combination of inverting and non-inverting inputs. NAND gates of six to nine inputs, 12 inputs, and 16 inputs are available with only non-inverting inputs. To invert inputs, use external inverters. Because each input uses a CLB resource, replace gates with unused inputs with gates having the necessary number of inputs.

### Design Entry Method

This design element is only for use in schematics.

### For More Information

See the [Spartan-6 FPGA User Documentation \(User Guides and Data Sheets\)](#).

## NAND4B4

### Primitive: 4-Input NAND Gate with Inverted Inputs

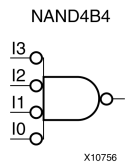

## Introduction

NAND elements implement Negated AND or NOT AND. A High (1) output results when one or more inputs are a Low (0). A Low (0) output results only if all inputs are High (1).

NAND gates of up to five inputs are available in any combination of inverting and non-inverting inputs. NAND gates of six to nine inputs, 12 inputs, and 16 inputs are available with only non-inverting inputs. To invert inputs, use external inverters. Because each input uses a CLB resource, replace gates with unused inputs with gates having the necessary number of inputs.

## Design Entry Method

This design element is only for use in schematics.

## For More Information

See the [Spartan-6 FPGA User Documentation \(User Guides and Data Sheets\)](#).

## NAND5

### Primitive: 5-Input NAND Gate with Non-Inverted Inputs

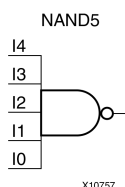

## Introduction

NAND elements implement Negated AND or NOT AND. A High (1) output results when one or more inputs are a Low (0). A Low (0) output results only if all inputs are High (1).

NAND gates of up to five inputs are available in any combination of inverting and non-inverting inputs. NAND gates of six to nine inputs, 12 inputs, and 16 inputs are available with only non-inverting inputs. To invert inputs, use external inverters. Because each input uses a CLB resource, replace gates with unused inputs with gates having the necessary number of inputs.

## Logic Table

Input	Output
I0 ... Iz	O
All inputs are 1	0
Any single input is 0	1

## Design Entry Method

This design element is only for use in schematics.

## For More Information

See the [Spartan-6 FPGA User Documentation \(User Guides and Data Sheets\)](#).



## NAND5B1

### Primitive: 5-Input NAND Gate with 1 Inverted and 4 Non-Inverted Inputs

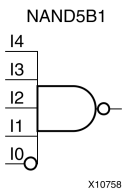

## Introduction

NAND elements implement Negated AND or NOT AND. A High (1) output results when one or more inputs are a Low (0). A Low (0) output results only if all inputs are High (1).

NAND gates of up to five inputs are available in any combination of inverting and non-inverting inputs. NAND gates of six to nine inputs, 12 inputs, and 16 inputs are available with only non-inverting inputs. To invert inputs, use external inverters. Because each input uses a CLB resource, replace gates with unused inputs with gates having the necessary number of inputs.

## Design Entry Method

This design element is only for use in schematics.

## For More Information

See the [Spartan-6 FPGA User Documentation \(User Guides and Data Sheets\)](#).

## NAND5B2

Primitive: 5-Input NAND Gate with 2 Inverted and 3 Non-Inverted Inputs

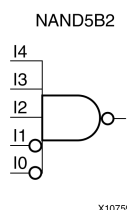

### Introduction

NAND elements implement Negated AND or NOT AND. A High (1) output results when one or more inputs are a Low (0). A Low (0) output results only if all inputs are High (1).

NAND gates of up to five inputs are available in any combination of inverting and non-inverting inputs. NAND gates of six to nine inputs, 12 inputs, and 16 inputs are available with only non-inverting inputs. To invert inputs, use external inverters. Because each input uses a CLB resource, replace gates with unused inputs with gates having the necessary number of inputs.

### Design Entry Method

This design element is only for use in schematics.

### For More Information

See the [Spartan-6 FPGA User Documentation \(User Guides and Data Sheets\)](#).

## NAND5B3

Primitive: 5-Input NAND Gate with 3 Inverted and 2 Non-Inverted Inputs

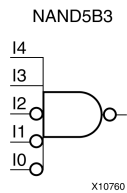

### Introduction

NAND gates of up to five inputs are available in any combination of inverting and non-inverting inputs. NAND gates of six to nine inputs, 12 inputs, and 16 inputs are available with only non-inverting inputs. To invert inputs, use external inverters. Because each input uses a CLB resource, replace gates with unused inputs with gates having the necessary number of inputs.

### Design Entry Method

This design element is only for use in schematics.

### For More Information

See the [Spartan-6 FPGA User Documentation \(User Guides and Data Sheets\)](#).

## NAND5B4

Primitive: 5-Input NAND Gate with 4 Inverted and 1 Non-Inverted Inputs

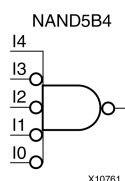

### Introduction

NAND elements implement Negated AND or NOT AND. A High (1) output results when one or more inputs are a Low (0). A Low (0) output results only if all inputs are High (1).

NAND gates of up to five inputs are available in any combination of inverting and non-inverting inputs. NAND gates of six to nine inputs, 12 inputs, and 16 inputs are available with only non-inverting inputs. To invert inputs, use external inverters. Because each input uses a CLB resource, replace gates with unused inputs with gates having the necessary number of inputs.

### Design Entry Method

This design element is only for use in schematics.

### For More Information

See the [Spartan-6 FPGA User Documentation \(User Guides and Data Sheets\)](#).

## NAND5B5

### Primitive: 5-Input NAND Gate with Inverted Inputs

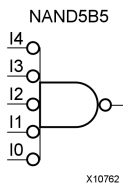

## Introduction

NAND elements implement Negated AND or NOT AND. A High (1) output results when one or more inputs are a Low (0). A Low (0) output results only if all inputs are High (1).

NAND gates of up to five inputs are available in any combination of inverting and non-inverting inputs. NAND gates of six to nine inputs, 12 inputs, and 16 inputs are available with only non-inverting inputs. To invert inputs, use external inverters. Because each input uses a CLB resource, replace gates with unused inputs with gates having the necessary number of inputs.

## Design Entry Method

This design element is only for use in schematics.

## For More Information

See the [Spartan-6 FPGA User Documentation \(User Guides and Data Sheets\)](#).

## NAND6

### Macro: 6-Input NAND Gate with Non-Inverted Inputs

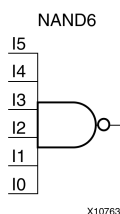

## Introduction

NAND elements implement Negated AND or NOT AND. A High (1) output results when one or more inputs are a Low (0). A Low (0) output results only if all inputs are High (1).

NAND gates of up to five inputs are available in any combination of inverting and non-inverting inputs. NAND gates of six to nine inputs, 12 inputs, and 16 inputs are available with only non-inverting inputs. To invert inputs, use external inverters. Because each input uses a CLB resource, replace gates with unused inputs with gates having the necessary number of inputs.

## Logic Table

Input	Output
I0 ... Iz	0
All inputs are 1	1
Any single input is 0	0

## Design Entry Method

This design element is only for use in schematics.

## For More Information

See the [Spartan-6 FPGA User Documentation \(User Guides and Data Sheets\)](#).

## NAND7

### Macro: 7-Input NAND Gate with Non-Inverted Inputs

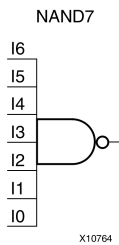

### Introduction

NAND elements implement Negated AND or NOT AND. A High (1) output results when one or more inputs are a Low (0). A Low (0) output results only if all inputs are High (1).

NAND gates of up to five inputs are available in any combination of inverting and non-inverting inputs. NAND gates of six to nine inputs, 12 inputs, and 16 inputs are available with only non-inverting inputs. To invert inputs, use external inverters. Because each input uses a CLB resource, replace gates with unused inputs with gates having the necessary number of inputs.

### Logic Table

Input	Output
I0 ... Iz	0
All inputs are 1	1
Any single input is 0	0

### Design Entry Method

This design element is only for use in schematics.

### For More Information

See the [Spartan-6 FPGA User Documentation \(User Guides and Data Sheets\)](#).

## NAND8

### Macro: 8-Input NAND Gate with Non-Inverted Inputs

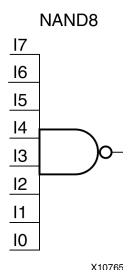

## Introduction

NAND elements implement Negated AND or NOT AND. A High (1) output results when one or more inputs are a Low (0). A Low (0) output results only if all inputs are High (1).

NAND gates of up to five inputs are available in any combination of inverting and non-inverting inputs. NAND gates of six to nine inputs, 12 inputs, and 16 inputs are available with only non-inverting inputs. To invert inputs, use external inverters. Because each input uses a CLB resource, replace gates with unused inputs with gates having the necessary number of inputs.

## Logic Table

Input	Output
I0 ... Iz	O
All inputs are 1	0
Any single input is 0	1

## Design Entry Method

This design element is only for use in schematics.

## For More Information

See the [Spartan-6 FPGA User Documentation \(User Guides and Data Sheets\)](#).



## NAND9

### Macro: 9-Input NAND Gate with Non-Inverted Inputs

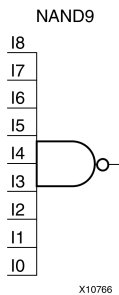

## Introduction

NAND elements implement Negated AND or NOT AND. A High (1) output results when one or more inputs are a Low (0). A Low (0) output results only if all inputs are High (1).

NAND gates of up to five inputs are available in any combination of inverting and non-inverting inputs. NAND gates of six to nine inputs, 12 inputs, and 16 inputs are available with only non-inverting inputs. To invert inputs, use external inverters. Because each input uses a CLB resource, replace gates with unused inputs with gates having the necessary number of inputs.

## Logic Table

Input	Output
I0 ... Iz	0
All inputs are 1	0
Any single input is 0	1

## Design Entry Method

This design element is only for use in schematics.

## For More Information

See the [Spartan-6 FPGA User Documentation \(User Guides and Data Sheets\)](#).

## NOR12

### Macro: 12-Input NOR Gate with Non-Inverted Inputs

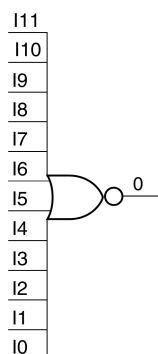

NOR12

X9433

## Introduction

NOR elements implement Negated OR, or NOT OR. A High (1) output results only when all inputs to the element are Low (0). A Low (0) output results if any inputs are high (1).

NOR gates of up to five inputs are available in any combination of inverting and non-inverting inputs. NOR gates of six to nine inputs, 12 inputs, and 16 inputs are available only with non-inverting inputs. To invert some or all inputs, use external inverters. Because each input uses a CLB resource, replace gates with unused inputs with gates having the necessary number of inputs.

## Logic Table

Input	Output
$I_0 \dots I_z$	$O$
Any input is 1	0
All inputs are 0	1

## Design Entry Method

This design element is only for use in schematics.

## For More Information

See the [Spartan-6 FPGA User Documentation \(User Guides and Data Sheets\)](#).

## NOR16

### Macro: 16-Input NOR Gate with Non-Inverted Inputs

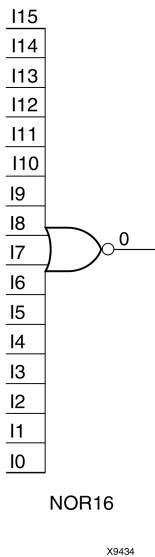

## Introduction

NOR elements implement Negated OR, or NOT OR. A High (1) output results only when all inputs to the element are Low (0). A Low (0) output results if any inputs are high (1).

NOR gates of up to five inputs are available in any combination of inverting and non-inverting inputs. NOR gates of six to nine inputs, 12 inputs, and 16 inputs are available only with non-inverting inputs. To invert some or all inputs, use external inverters. Because each input uses a CLB resource, replace gates with unused inputs with gates having the necessary number of inputs.

## Logic Table

Input	Output
I0 ... Iz	O
Any input is 1	0
All inputs are 0	1

## Design Entry Method

This design element is only for use in schematics.

## For More Information

See the [Spartan-6 FPGA User Documentation \(User Guides and Data Sheets\)](#).

## NOR2

### Primitive: 2-Input NOR Gate with Non-Inverted Inputs

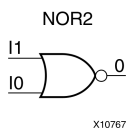

## Introduction

NOR elements implement Negated OR, or NOT OR. A High (1) output results only when all inputs to the element are Low (0). A Low (0) output results if any inputs are high (1).

NOR gates of up to five inputs are available in any combination of inverting and non-inverting inputs. NOR gates of six to nine inputs, 12 inputs, and 16 inputs are available only with non-inverting inputs. To invert some or all inputs, use external inverters. Because each input uses a CLB resource, replace gates with unused inputs with gates having the necessary number of inputs.

## Logic Table

Input	Output
I0 ... Iz	0
Any input is 1	0
All inputs are 0	1

## Design Entry Method

This design element is only for use in schematics.

## For More Information

See the [Spartan-6 FPGA User Documentation \(User Guides and Data Sheets\)](#).

## NOR2B1

Primitive: 2-Input NOR Gate with 1 Inverted and 1 Non-Inverted Inputs

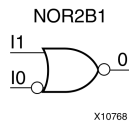

### Introduction

NOR elements implement Negated OR, or NOT OR. A High (1) output results only when all inputs to the element are Low (0). A Low (0) output results if any inputs are high (1).

NOR gates of up to five inputs are available in any combination of inverting and non-inverting inputs. NOR gates of six to nine inputs, 12 inputs, and 16 inputs are available only with non-inverting inputs. To invert some or all inputs, use external inverters. Because each input uses a CLB resource, replace gates with unused inputs with gates having the necessary number of inputs.

### Design Entry Method

This design element is only for use in schematics.

### For More Information

See the [Spartan-6 FPGA User Documentation \(User Guides and Data Sheets\)](#).

## NOR2B2

### Primitive: 2-Input NOR Gate with Inverted Inputs

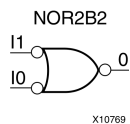

## Introduction

NOR elements implement Negated OR, or NOT OR. A High (1) output results only when all inputs to the element are Low (0). A Low (0) output results if any inputs are high (1).

NOR gates of up to five inputs are available in any combination of inverting and non-inverting inputs. NOR gates of six to nine inputs, 12 inputs, and 16 inputs are available only with non-inverting inputs. To invert some or all inputs, use external inverters. Because each input uses a CLB resource, replace gates with unused inputs with gates having the necessary number of inputs.

## Design Entry Method

This design element is only for use in schematics.

## For More Information

See the [Spartan-6 FPGA User Documentation \(User Guides and Data Sheets\)](#).

## NOR3

### Primitive: 3-Input NOR Gate with Non-Inverted Inputs

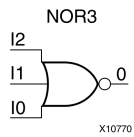

## Introduction

NOR elements implement Negated OR, or NOT OR. A High (1) output results only when all inputs to the element are Low (0). A Low (0) output results if any inputs are high (1).

NOR gates of up to five inputs are available in any combination of inverting and non-inverting inputs. NOR gates of six to nine inputs, 12 inputs, and 16 inputs are available only with non-inverting inputs. To invert some or all inputs, use external inverters. Because each input uses a CLB resource, replace gates with unused inputs with gates having the necessary number of inputs.

## Logic Table

Input	Output
I0 ... Iz	0
Any input is 1	0
All inputs are 0	1

## Design Entry Method

This design element is only for use in schematics.

## For More Information

See the [Spartan-6 FPGA User Documentation \(User Guides and Data Sheets\)](#).

## NOR3B1

### Primitive: 3-Input NOR Gate with 1 Inverted and 2 Non-Inverted Inputs

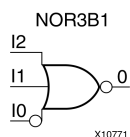

## Introduction

NOR elements implement Negated OR, or NOT OR. A High (1) output results only when all inputs to the element are Low (0). A Low (0) output results if any inputs are high (1).

NOR gates of up to five inputs are available in any combination of inverting and non-inverting inputs. NOR gates of six to nine inputs, 12 inputs, and 16 inputs are available only with non-inverting inputs. To invert some or all inputs, use external inverters. Because each input uses a CLB resource, replace gates with unused inputs with gates having the necessary number of inputs.

## Design Entry Method

This design element is only for use in schematics.

## For More Information

See the [Spartan-6 FPGA User Documentation \(User Guides and Data Sheets\)](#).



## NOR3B2

### Primitive: 3-Input NOR Gate with 2 Inverted and 1 Non-Inverted Inputs

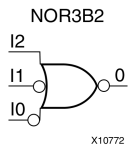

## Introduction

NOR elements implement Negated OR, or NOT OR. A High (1) output results only when all inputs to the element are Low (0). A Low (0) output results if any inputs are high (1).

NOR gates of up to five inputs are available in any combination of inverting and non-inverting inputs. NOR gates of six to nine inputs, 12 inputs, and 16 inputs are available only with non-inverting inputs. To invert some or all inputs, use external inverters. Because each input uses a CLB resource, replace gates with unused inputs with gates having the necessary number of inputs.

## Design Entry Method

This design element is only for use in schematics.

## For More Information

See the [Spartan-6 FPGA User Documentation \(User Guides and Data Sheets\)](#).

## NOR3B3

### Primitive: 3-Input NOR Gate with Inverted Inputs

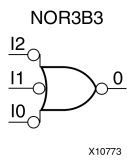

## Introduction

NOR elements implement Negated OR, or NOT OR. A High (1) output results only when all inputs to the element are Low (0). A Low (0) output results if any inputs are high (1).

NOR gates of up to five inputs are available in any combination of inverting and non-inverting inputs. NOR gates of six to nine inputs, 12 inputs, and 16 inputs are available only with non-inverting inputs. To invert some or all inputs, use external inverters. Because each input uses a CLB resource, replace gates with unused inputs with gates having the necessary number of inputs.

## Design Entry Method

This design element is only for use in schematics.

## For More Information

See the [Spartan-6 FPGA User Documentation \(User Guides and Data Sheets\)](#).

## NOR4

### Primitive: 4-Input NOR Gate with Non-Inverted Inputs

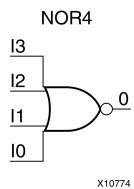

## Introduction

NOR elements implement Negated OR, or NOT OR. A High (1) output results only when all inputs to the element are Low (0). A Low (0) output results if any inputs are high (1).

NOR gates of up to five inputs are available in any combination of inverting and non-inverting inputs. NOR gates of six to nine inputs, 12 inputs, and 16 inputs are available only with non-inverting inputs. To invert some or all inputs, use external inverters. Because each input uses a CLB resource, replace gates with unused inputs with gates having the necessary number of inputs.

## Logic Table

Input	Output
I0 ... Iz	0
Any input is 1	0
All inputs are 0	1

## Design Entry Method

This design element is only for use in schematics.

## For More Information

See the [Spartan-6 FPGA User Documentation \(User Guides and Data Sheets\)](#).

## NOR4B1

Primitive: 4-Input NOR Gate with 1 Inverted and 3 Non-Inverted Inputs

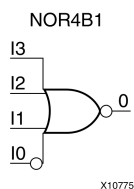

### Introduction

NOR elements implement Negated OR, or NOT OR. A High (1) output results only when all inputs to the element are Low (0). A Low (0) output results if any inputs are high (1).

NOR gates of up to five inputs are available in any combination of inverting and non-inverting inputs. NOR gates of six to nine inputs, 12 inputs, and 16 inputs are available only with non-inverting inputs. To invert some or all inputs, use external inverters. Because each input uses a CLB resource, replace gates with unused inputs with gates having the necessary number of inputs.

### Design Entry Method

This design element is only for use in schematics.

### For More Information

See the [Spartan-6 FPGA User Documentation \(User Guides and Data Sheets\)](#).

## NOR4B2

### Primitive: 4-Input NOR Gate with 2 Inverted and 2 Non-Inverted Inputs

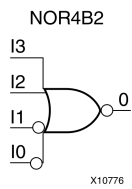

## Introduction

NOR elements implement Negated OR, or NOT OR. A High (1) output results only when all inputs to the element are Low (0). A Low (0) output results if any inputs are high (1).

NOR gates of up to five inputs are available in any combination of inverting and non-inverting inputs. NOR gates of six to nine inputs, 12 inputs, and 16 inputs are available only with non-inverting inputs. To invert some or all inputs, use external inverters. Because each input uses a CLB resource, replace gates with unused inputs with gates having the necessary number of inputs.

## Design Entry Method

This design element is only for use in schematics.

## For More Information

See the [Spartan-6 FPGA User Documentation \(User Guides and Data Sheets\)](#).

## NOR4B3

### Primitive: 4-Input NOR Gate with 3 Inverted and 1 Non-Inverted Inputs

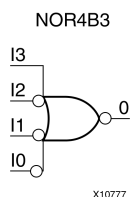

## Introduction

NOR elements implement Negated OR, or NOT OR. A High (1) output results only when all inputs to the element are Low (0). A Low (0) output results if any inputs are high (1).

NOR gates of up to five inputs are available in any combination of inverting and non-inverting inputs. NOR gates of six to nine inputs, 12 inputs, and 16 inputs are available only with non-inverting inputs. To invert some or all inputs, use external inverters. Because each input uses a CLB resource, replace gates with unused inputs with gates having the necessary number of inputs.

## Design Entry Method

This design element is only for use in schematics.

## For More Information

See the [Spartan-6 FPGA User Documentation \(User Guides and Data Sheets\)](#).

## NOR4B4

### Primitive: 4-Input NOR Gate with Inverted Inputs

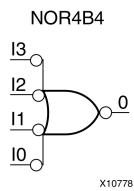

## Introduction

NOR elements implement Negated OR, or NOT OR. A High (1) output results only when all inputs to the element are Low (0). A Low (0) output results if any inputs are high (1).

NOR gates of up to five inputs are available in any combination of inverting and non-inverting inputs. NOR gates of six to nine inputs, 12 inputs, and 16 inputs are available only with non-inverting inputs. To invert some or all inputs, use external inverters. Because each input uses a CLB resource, replace gates with unused inputs with gates having the necessary number of inputs.

## Design Entry Method

This design element is only for use in schematics.

## For More Information

See the [Spartan-6 FPGA User Documentation \(User Guides and Data Sheets\)](#).

## NOR5

### Primitive: 5-Input NOR Gate with Non-Inverted Inputs

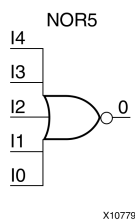

## Introduction

NOR elements implement Negated OR, or NOT OR. A High (1) output results only when all inputs to the element are Low (0). A Low (0) output results if any inputs are high (1).

NOR gates of up to five inputs are available in any combination of inverting and non-inverting inputs. NOR gates of six to nine inputs, 12 inputs, and 16 inputs are available only with non-inverting inputs. To invert some or all inputs, use external inverters. Because each input uses a CLB resource, replace gates with unused inputs with gates having the necessary number of inputs.

## Logic Table

Input	Output
I0 ... Iz	0
Any input is 1	0
All inputs are 0	1

## Design Entry Method

This design element is only for use in schematics.

## For More Information

See the [Spartan-6 FPGA User Documentation \(User Guides and Data Sheets\)](#).



## NOR5B1

Primitive: 5-Input NOR Gate with 1 Inverted and 4 Non-Inverted Inputs

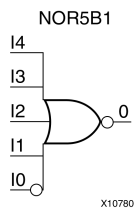

### Introduction

NOR elements implement Negated OR, or NOT OR. A High (1) output results only when all inputs to the element are Low (0). A Low (0) output results if any inputs are high (1).

NOR gates of up to five inputs are available in any combination of inverting and non-inverting inputs. NOR gates of six to nine inputs, 12 inputs, and 16 inputs are available only with non-inverting inputs. To invert some or all inputs, use external inverters. Because each input uses a CLB resource, replace gates with unused inputs with gates having the necessary number of inputs.

### Design Entry Method

This design element is only for use in schematics.

### For More Information

See the [Spartan-6 FPGA User Documentation \(User Guides and Data Sheets\)](#).

## NOR5B2

### Primitive: 5-Input NOR Gate with 2 Inverted and 3 Non-Inverted Inputs

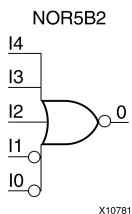

## Introduction

NOR elements implement Negated OR, or NOT OR. A High (1) output results only when all inputs to the element are Low (0). A Low (0) output results if any inputs are high (1).

NOR gates of up to five inputs are available in any combination of inverting and non-inverting inputs. NOR gates of six to nine inputs, 12 inputs, and 16 inputs are available only with non-inverting inputs. To invert some or all inputs, use external inverters. Because each input uses a CLB resource, replace gates with unused inputs with gates having the necessary number of inputs.

## Design Entry Method

This design element is only for use in schematics.

## For More Information

See the [Spartan-6 FPGA User Documentation \(User Guides and Data Sheets\)](#).

## NOR5B3

Primitive: 5-Input NOR Gate with 3 Inverted and 2 Non-Inverted Inputs

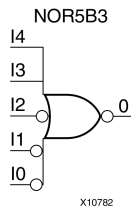

### Introduction

NOR elements implement Negated OR, or NOT OR. A High (1) output results only when all inputs to the element are Low (0). A Low (0) output results if any inputs are high (1).

NOR gates of up to five inputs are available in any combination of inverting and non-inverting inputs. NOR gates of six to nine inputs, 12 inputs, and 16 inputs are available only with non-inverting inputs. To invert some or all inputs, use external inverters. Because each input uses a CLB resource, replace gates with unused inputs with gates having the necessary number of inputs.

### Design Entry Method

This design element is only for use in schematics.

### For More Information

See the [Spartan-6 FPGA User Documentation \(User Guides and Data Sheets\)](#).

## NOR5B4

Primitive: 5-Input NOR Gate with 4 Inverted and 1 Non-Inverted Inputs

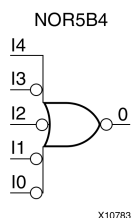

### Introduction

NOR elements implement Negated OR, or NOT OR. A High (1) output results only when all inputs to the element are Low (0). A Low (0) output results if any inputs are high (1).

NOR gates of up to five inputs are available in any combination of inverting and non-inverting inputs. NOR gates of six to nine inputs, 12 inputs, and 16 inputs are available only with non-inverting inputs. To invert some or all inputs, use external inverters. Because each input uses a CLB resource, replace gates with unused inputs with gates having the necessary number of inputs.

### Design Entry Method

This design element is only for use in schematics.

### For More Information

See the [Spartan-6 FPGA User Documentation \(User Guides and Data Sheets\)](#).

## NOR5B5

### Primitive: 5-Input NOR Gate with Inverted Inputs

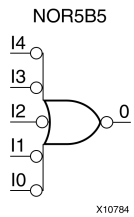

## Introduction

NOR elements implement Negated OR, or NOT OR. A High (1) output results only when all inputs to the element are Low (0). A Low (0) output results if any inputs are high (1).

NOR gates of up to five inputs are available in any combination of inverting and non-inverting inputs. NOR gates of six to nine inputs, 12 inputs, and 16 inputs are available only with non-inverting inputs. To invert some or all inputs, use external inverters. Because each input uses a CLB resource, replace gates with unused inputs with gates having the necessary number of inputs.

## Design Entry Method

This design element is only for use in schematics.

## For More Information

See the [Spartan-6 FPGA User Documentation \(User Guides and Data Sheets\)](#).

## NOR6

### Macro: 6-Input NOR Gate with Non-Inverted Inputs

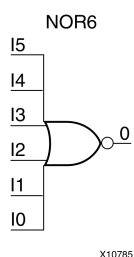

## Introduction

NOR elements implement Negated OR, or NOT OR. A High (1) output results only when all inputs to the element are Low (0). A Low (0) output results if any inputs are high (1).

NOR gates of up to five inputs are available in any combination of inverting and non-inverting inputs. NOR gates of six to nine inputs, 12 inputs, and 16 inputs are available only with non-inverting inputs. To invert some or all inputs, use external inverters. Because each input uses a CLB resource, replace gates with unused inputs with gates having the necessary number of inputs.

## Logic Table

Input	Output
I0 ... Iz	0
Any input is 1	0
All inputs are 0	1

## Design Entry Method

This design element is only for use in schematics.

## For More Information

See the [Spartan-6 FPGA User Documentation \(User Guides and Data Sheets\)](#).

## NOR7

### Macro: 7-Input NOR Gate with Non-Inverted Inputs

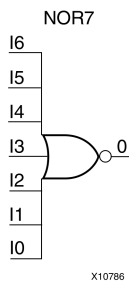

## Introduction

NOR elements implement Negated OR, or NOT OR. A High (1) output results only when all inputs to the element are Low (0). A Low (0) output results if any inputs are high (1).

NOR gates of up to five inputs are available in any combination of inverting and non-inverting inputs. NOR gates of six to nine inputs, 12 inputs, and 16 inputs are available only with non-inverting inputs. To invert some or all inputs, use external inverters. Because each input uses a CLB resource, replace gates with unused inputs with gates having the necessary number of inputs.

## Logic Table

Input	Output
I0 ... Iz	O
Any input is 1	0
All inputs are 0	1

## Design Entry Method

This design element is only for use in schematics.

## For More Information

See the [Spartan-6 FPGA User Documentation \(User Guides and Data Sheets\)](#).

## NOR8

### Macro: 8-Input NOR Gate with Non-Inverted Inputs

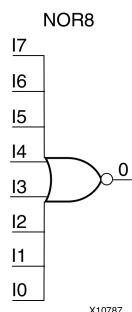

## Introduction

NOR elements implement Negated OR, or NOT OR. A High (1) output results only when all inputs to the element are Low (0). A Low (0) output results if any inputs are high (1).

NOR gates of up to five inputs are available in any combination of inverting and non-inverting inputs. NOR gates of six to nine inputs, 12 inputs, and 16 inputs are available only with non-inverting inputs. To invert some or all inputs, use external inverters. Because each input uses a CLB resource, replace gates with unused inputs with gates having the necessary number of inputs.

## Logic Table

Input	Output
I0 ... Iz	0
Any input is 1	0
All inputs are 0	1

## Design Entry Method

This design element is only for use in schematics.

## For More Information

See the [Spartan-6 FPGA User Documentation \(User Guides and Data Sheets\)](#).



## NOR9

### Macro: 9-Input NOR Gate with Non-Inverted Inputs

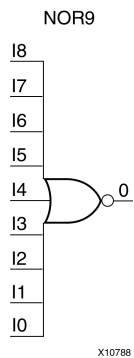

### Introduction

NOR elements implement Negated OR, or NOT OR. A High (1) output results only when all inputs to the element are Low (0). A Low (0) output results if any inputs are high (1).

NOR gates of up to five inputs are available in any combination of inverting and non-inverting inputs. NOR gates of six to nine inputs, 12 inputs, and 16 inputs are available only with non-inverting inputs. To invert some or all inputs, use external inverters. Because each input uses a CLB resource, replace gates with unused inputs with gates having the necessary number of inputs.

### Logic Table

Input	Output
I0 ... Iz	0
Any input is 1	0
All inputs are 0	1

### Design Entry Method

This design element is only for use in schematics.

### For More Information

See the [Spartan-6 FPGA User Documentation \(User Guides and Data Sheets\)](#).

## OBUF

### Primitive: Output Buffer

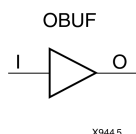

## Introduction

This design element is a simple output buffer used to drive output signals to the FPGA device pins that do not need to be 3-stated (constantly driven). Either an OBUF, OBUFT, OBUFDS, or OBUFTDS must be connected to every output port in the design.

This element isolates the internal circuit and provides drive current for signals leaving a chip. It exists in input/output blocks (IOB). Its output (O) is connected to an OPAD or an IOPAD. The interface standard used by this element is LVTTTL. Also, this element has selectable drive and slew rates using the DRIVE and SLOW or FAST constraints. The defaults are DRIVE=12 mA and SLOW slew.

## Port Descriptions

Port	Direction	Width	Function
O	Output	1	Output of OBUF to be connected directly to top-level output port.
I	Input	1	Input of OBUF. Connect to the logic driving the output port.

## Design Entry Method

This design element can be used in schematics.

## Available Attributes

Attribute	Data Type	Allowed Values	Default	Description
IOSTANDARD	String	See Data Sheet	"DEFAULT"	Assigns an I/O standard to the element.

## For More Information

- See the [Spartan-6 FPGA SelectIO Resources User Guide \(UG381\)](#).
- See the [Spartan-6 FPGA Data Sheet: DC and Switching Characteristics \(DS162\)](#).

## OBUF16

### Macro: 16-Bit Output Buffer

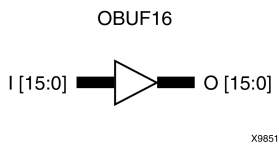

## Introduction

This design element is a multiple output buffer.

This element isolates the internal circuit and provides drive current for signals leaving a chip. It exists in input/output blocks (IOB). Its output (O) is connected to an OPAD or an IOPAD. The interface standard used by this element is LVTTTL. Also, this element has selectable drive and slew rates using the DRIVE and SLOW or FAST constraints. The defaults are DRIVE=12 mA and SLOW slew.

## Design Entry Method

This design element can be used in schematics.

## Available Attributes

Attribute	Data Type	Allowed Values	Default	Description
IOSTANDARD	String	See Data Sheet	"DEFAULT"	Assigns an I/O standard to the element.

## For More Information

See the [Spartan-6 FPGA User Documentation \(User Guides and Data Sheets\)](#).

## OBUF4

### Macro: 4-Bit Output Buffer

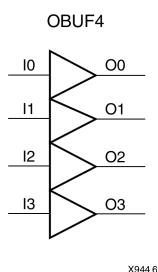

## Introduction

This design element is a multiple output buffer.

This element isolates the internal circuit and provides drive current for signals leaving a chip. It exists in input/output blocks (IOB). Its output (O) is connected to an OPAD or an IOPAD. The interface standard used by this element is LVTTTL. Also, this element has selectable drive and slew rates using the DRIVE and SLOW or FAST constraints. The defaults are DRIVE=12 mA and SLOW slew.

## Design Entry Method

This design element can be used in schematics.

## Available Attributes

Attribute	Data Type	Allowed Values	Default	Description
IOSTANDARD	String	See Data Sheet	"DEFAULT"	Assigns an I/O standard to the element.

## For More Information

See the [Spartan-6 FPGA User Documentation \(User Guides and Data Sheets\)](#).

## OBUF8

### Macro: 8-Bit Output Buffer

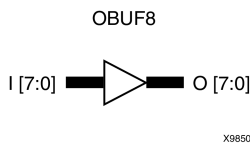

## Introduction

This design element is a multiple output buffer.

This element isolates the internal circuit and provides drive current for signals leaving a chip. It exists in input/output blocks (IOB). Its output (O) is connected to an OPAD or an IOPAD. The interface standard used by this element is LVTTTL. Also, this element has selectable drive and slew rates using the DRIVE and SLOW or FAST constraints. The defaults are DRIVE=12 mA and SLOW slew.

## Design Entry Method

This design element can be used in schematics.

## Available Attributes

Attribute	Data Type	Allowed Values	Default	Description
IOSTANDARD	String	See Data Sheet	"DEFAULT"	Assigns an I/O standard to the element.

## For More Information

See the [Spartan-6 FPGA User Documentation \(User Guides and Data Sheets\)](#).

## OBUFDS

### Primitive: Differential Signaling Output Buffer

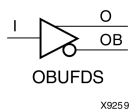

## Introduction

This design element is a single output buffer that supports low-voltage, differential signaling (1.8 v CMOS). OBUFDS isolates the internal circuit and provides drive current for signals leaving the chip. Its output is represented as two distinct ports (O and OB), one deemed the "master" and the other the "slave." The master and the slave are opposite phases of the same logical signal (for example, MYNET and MYNETB).

## Logic Table

Inputs	Outputs	
I	O	OB
0	0	1
1	1	0

## Port Descriptions

Port	Direction	Width	Function
O	Output	1	Diff_p output (connect directly to top level port)
OB	Output	1	Diff_n output (connect directly to top level port)
I	Input	1	Buffer input

## Design Entry Method

This design element can be used in schematics.

## Available Attributes

Attribute	Data Type	Allowed Values	Default	Description
IOSTANDARD	String	See Data Sheet	"DEFAULT"	Assigns an I/O standard to the element.

## For More Information

- See the [Spartan-6 FPGA SelectIO Resources User Guide \(UG381\)](#).
- See the [Spartan-6 FPGA Data Sheet: DC and Switching Characteristics \(DS162\)](#).

## OBUFT

### Primitive: 3-State Output Buffer with Active Low Output Enable

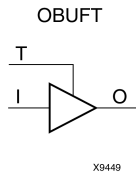

## Introduction

This design element is a single, 3-state output buffer with input I, output O, and active-Low output enables (T). This element uses the LVTTTL standard and has selectable drive and slew rates using the DRIVE and SLOW or FAST constraints. The defaults are DRIVE=12 mA and SLOW slew.

When T is Low, data on the inputs of the buffers is transferred to the corresponding outputs. When T is High, the output is high impedance (off or Z state). OBUFTs are generally used when a single-ended output is needed with a 3-state capability, such as the case when building bidirectional I/O.

## Logic Table

Inputs		Outputs
T	I	O
1	X	Z
0	1	1
0	0	0

## Port Descriptions

Port	Direction	Width	Function
O	Output	1	Buffer output (connect directly to top-level port)
I	Input	1	Buffer input
T	Input	1	3-state enable input

## Design Entry Method

This design element can be used in schematics.

## Available Attributes

Attribute	Data Type	Allowed Values	Default	Description
DRIVE	Integer	2, 4, 6, 8, 12, 16, 24	12	Specifies the output current drive strength of the I/O. You should set this to the lowest setting tolerable for the design drive and timing requirements.
IOSTANDARD	String	See Data Sheet	"DEFAULT"	Assigns an I/O standard to the element.
SLEW	String	"SLOW" or "FAST"	"SLOW"	Specifies the slew rate of the output driver. See the Data Sheet for recommendations of the best setting for this attribute.

## For More Information

- See the [Spartan-6 FPGA SelectIO Resources User Guide \(UG381\)](#).
- See the [Spartan-6 FPGA Data Sheet: DC and Switching Characteristics \(DS162\)](#).



## OBUFT16

### Macro: 16-Bit 3-State Output Buffer with Active Low Output Enable

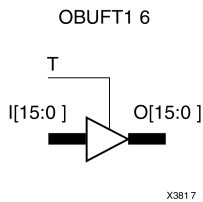

## Introduction

This design element is a multiple, 3-state output buffer with input I, output O, and active-Low output enables (T). This element uses the LVTTTL standard and has selectable drive and slew rates using the DRIVE and SLOW or FAST constraints. The defaults are DRIVE=12 mA and SLOW slew.

When T is Low, data on the inputs of the buffers is transferred to the corresponding outputs. When T is High, the output is high impedance (off or Z state). OBUFTs are generally used when a single-ended output is needed with a 3-state capability, such as the case when building bidirectional I/O.

## Logic Table

Inputs		Outputs
T	I	O
1	X	Z
0	1	1
0	0	0

## Design Entry Method

This design element is only for use in schematics.

## Available Attributes

Attribute	Data Type	Allowed Values	Default	Description
DRIVE	Integer	2, 4, 6, 8, 12, 16, 24	12	Specifies the output current drive strength of the I/O. You should set this to the lowest setting tolerable for the design drive and timing requirements.
IOSTANDARD	String	See Data Sheet	"DEFAULT"	Assigns an I/O standard to the element.
SLEW	String	"SLOW" or "FAST"	"SLOW"	Specifies the slew rate of the output driver. See the Data Sheet for recommendations of the best setting for this attribute.

## For More Information

See the [Spartan-6 FPGA User Documentation \(User Guides and Data Sheets\)](#).

## OBUFT4

### Macro: 4-Bit 3-State Output Buffers with Active-Low Output Enable

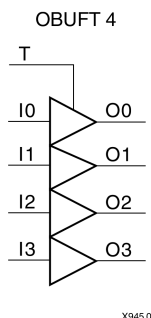

## Introduction

This design element is a multiple, 3-state output buffer with input I, output O, and active-Low output enables (T). This element uses the LVTTL standard and has selectable drive and slew rates using the DRIVE and SLOW or FAST constraints. The defaults are DRIVE=12 mA and SLOW slew.

When T is Low, data on the inputs of the buffers is transferred to the corresponding outputs. When T is High, the output is high impedance (off or Z state). OBUFTs are generally used when a single-ended output is needed with a 3-state capability, such as the case when building bidirectional I/O.

## Logic Table

Inputs		Outputs
T	I	O
1	X	Z
0	1	1
0	0	0

## Design Entry Method

This design element is only for use in schematics.

## Available Attributes

Attribute	Data Type	Allowed Values	Default	Description
DRIVE	Integer	2, 4, 6, 8, 12, 16, 24	12	Specifies the output current drive strength of the I/O. You should set this to the lowest setting tolerable for the design drive and timing requirements.
IOSTANDARD	String	See Data Sheet	"DEFAULT"	Assigns an I/O standard to the element.
SLEW	String	"SLOW" or "FAST"	"SLOW"	Specifies the slew rate of the output driver. See the Data Sheet for recommendations of the best setting for this attribute.

## For More Information

See the [Spartan-6 FPGA User Documentation \(User Guides and Data Sheets\)](#).

## OBUFT8

### Macro: 8-Bit 3-State Output Buffers with Active-Low Output Enable

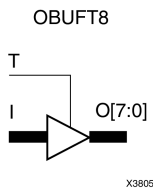

## Introduction

This design element is a multiple, 3-state output buffer with input I, output O, and active-Low output enables (T). This element uses the LVTTL standard and has selectable drive and slew rates using the DRIVE and SLOW or FAST constraints. The defaults are DRIVE=12 mA and SLOW slew.

When T is Low, data on the inputs of the buffers is transferred to the corresponding outputs. When T is High, the output is high impedance (off or Z state). OBUFTs are generally used when a single-ended output is needed with a 3-state capability, such as the case when building bidirectional I/O.

## Logic Table

Inputs		Outputs
T	I	O
1	X	Z
0	1	1
0	0	0

## Design Entry Method

This design element is only for use in schematics.

## Available Attributes

Attribute	Data Type	Allowed Values	Default	Description
DRIVE	Integer	2, 4, 6, 8, 12, 16, 24	12	Specifies the output current drive strength of the I/O. You should set this to the lowest setting tolerable for the design drive and timing requirements.
IOSTANDARD	String	See Data Sheet	"DEFAULT"	Assigns an I/O standard to the element.
SLEW	String	"SLOW" or "FAST"	"SLOW"	Specifies the slew rate of the output driver. See the Data Sheet for recommendations of the best setting for this attribute.

## For More Information

See the [Spartan-6 FPGA User Documentation \(User Guides and Data Sheets\)](#).

## OBUFTDS

Primitive: 3-State Output Buffer with Differential Signaling, Active-Low Output Enable

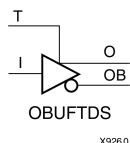

### Introduction

This design element is an output buffer that supports low-voltage, differential signaling. For the OBUFTDS, a design level interface signal is represented as two distinct ports (O and OB), one deemed the "master" and the other the "slave." The master and the slave are opposite phases of the same logical signal (for example, MYNET\_P and MYNET\_N).

### Logic Table

Inputs		Outputs	
I	T	O	OB
X	1	Z	Z
0	0	0	1
1	0	1	0

### Port Descriptions

Port	Direction	Width	Function
O	Output	1	Diff_p output (connect directly to top level port)
OB	Output	1	Diff_n output (connect directly to top level port)
I	Input	1	Buffer input
T	Input	1	3-state enable input

### Design Entry Method

This design element can be used in schematics.

### Available Attributes

Attribute	Data Type	Allowed Values	Default	Description
IOSTANDARD	String	See Data Sheet	"DEFAULT"	Assigns an I/O standard to the element.

### For More Information

- See the [Spartan-6 FPGA SelectIO Resources User Guide \(UG381\)](#).
- See the [Spartan-6 FPGA Data Sheet: DC and Switching Characteristics \(DS162\)](#).

# ODDR2

Primitive: Dual Data Rate Output D Flip-Flop with Optional Data Alignment, Clock Enable and Programmable Synchronous or Asynchronous Set/Reset

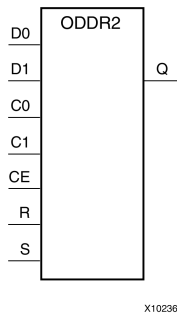

## Introduction

The design element is an output double data rate (DDR) register useful in producing double data rate signals exiting the FPGA. The ODDR2 requires two clocks (C0 and C1) to be connected to the component so that data is provided at the positive edge of both clocks. The ODDR2 features an active high clock enable port, CE, which can be used to suspend the operation of the registers and both set and reset ports that can be configured to be synchronous or asynchronous to the respective clocks. The ODDR2 has an optional alignment feature, which allows data to be captured by a single clock and clocked out by two clocks.

## Logic Table

Inputs							Outputs
S	R	CE	D0	D1	C0	C1	O
1	X	X	X	X	X	X	1
0	1	X	X	X	X	X	0
0	0	0	X	X	X	X	No Change
0	0	1	D0	X	↑	X	D0
0	0	1	X	D1	X	↑	D1

Set/Reset can be synchronous via SRTYPE value

## Design Entry Method

This design element can be used in schematics.

## Available Attributes

Attribute	Data Type	Allowed Values	Default	Descriptions
DDR_ALIGNMENT	String	"NONE", "C0", "C1"	"NONE"	<p>Sets the input capture behavior for the DDR register.</p> <ul style="list-style-type: none"> <li>"NONE" clocks in data to the D0 input on the positive transition of the C0 clock and D1 on the positive transition of the C1 clock.</li> <li>"C0" allows the input clocking of both D0 and D1 align to the positive edge of the C0 clock.</li> <li>"C1" allows the input clocking of both D0 and D1 align to the positive edge of the C1 clock.</li> </ul>
INIT	Binary	0, 1	0	Sets the initial state of the Q output to 0 or 1.
SRTYPE	String	"SYNC", "ASYNC"	"SYNC"	Specifies "SYNC" or "ASYNC" set/reset.

## For More Information

- See the [Spartan-6 FPGA Configurable Logic Block User Guide \(UG384\)](#).
- See the [Spartan-6 FPGA Data Sheet: DC and Switching Characteristics \(DS162\)](#).

## OFD

### Macro: Output D Flip-Flop

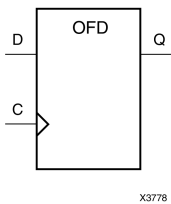

## Introduction

This design element is a single output D flip-flop.

The outputs are connected to OPADs or IOPADs. The data on the (D) inputs is loaded into the flip-flops during the Low-to-High clock (C) transition and appears on the (Q) outputs.

This flip-flop is asynchronously cleared, outputs Low, when power is applied. For FPGA devices, power-on conditions are simulated when global set/reset (GSR) is active. GSR defaults to active-High but can be inverted by adding an inverter in front of the GSR input of the appropriate `STARTUP_architecture` symbol.

## Logic Table

Inputs		Outputs
D	C	Q
D	↑	D

## Design Entry Method

This design element is only for use in schematics.

## For More Information

See the [Spartan-6 FPGA User Documentation \(User Guides and Data Sheets\)](#).

## OFD\_1

### Macro: Output D Flip-Flop with Inverted Clock

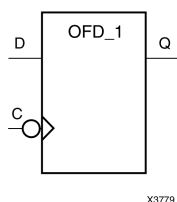

## Introduction

The design element is located in an input/output block (IOB). The output (Q) of the D flip-flop is connected to an OPAD or an IOPAD. The data on the (D) input is loaded into the flip-flop during the High-to-Low clock (C) transition and appears on the (Q) output.

This flip-flop is asynchronously cleared, outputs Low, when power is applied. For FPGA devices, power-on conditions are simulated when global set/reset (GSR) is active. GSR defaults to active-High but can be inverted by adding an inverter in front of the GSR input of the appropriate `STARTUP_architecture` symbol.

## Logic Table

Inputs		Outputs
D	C	Q
D	↓	D

## Design Entry Method

This design element is only for use in schematics.

## For More Information

See the [Spartan-6 FPGA User Documentation \(User Guides and Data Sheets\)](#).



## OFD16

### Macro: 16-Bit Output D Flip-Flop

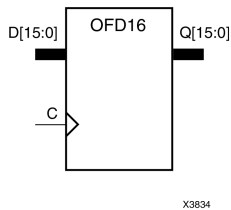

## Introduction

This design element is a multiple output D flip-flop.

The outputs are connected to OPADs or IOPADs. The data on the (D) inputs is loaded into the flip-flops during the Low-to-High clock (C) transition and appears on the (Q) outputs.

This flip-flop is asynchronously cleared, outputs Low, when power is applied. For FPGA devices, power-on conditions are simulated when global set/reset (GSR) is active. GSR defaults to active-High but can be inverted by adding an inverter in front of the GSR input of the appropriate *STARTUP\_architecture* symbol.

## Logic Table

Inputs		Outputs
D	C	Q
D	↑	D

## Design Entry Method

This design element is only for use in schematics.

## For More Information

See the [Spartan-6 FPGA User Documentation \(User Guides and Data Sheets\)](#).

## OFD4

### Macro: 4-Bit Output D Flip-Flop

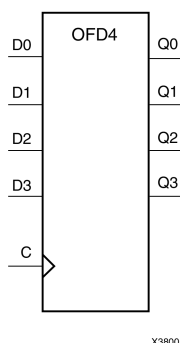

## Introduction

This design element is a multiple output D flip-flop.

The outputs are connected to OPADs or IOPADs. The data on the (D) inputs is loaded into the flip-flops during the Low-to-High clock (C) transition and appears on the (Q) outputs.

This flip-flop is asynchronously cleared, outputs Low, when power is applied. For FPGA devices, power-on conditions are simulated when global set/reset (GSR) is active. GSR defaults to active-High but can be inverted by adding an inverter in front of the GSR input of the appropriate `STARTUP_architecture` symbol.

## Logic Table

Inputs		Outputs
D	C	Q
D	↑	D

## Design Entry Method

This design element is only for use in schematics.

## For More Information

See the [Spartan-6 FPGA User Documentation \(User Guides and Data Sheets\)](#).

## OFD8

### Macro: 8-Bit Output D Flip-Flop

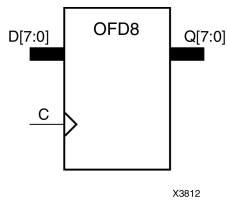

## Introduction

This design element is a multiple output D flip-flop.

The outputs are connected to OPADs or IOPADs. The data on the (D) inputs is loaded into the flip-flops during the Low-to-High clock (C) transition and appears on the (Q) outputs.

This flip-flop is asynchronously cleared, outputs Low, when power is applied. For FPGA devices, power-on conditions are simulated when global set/reset (GSR) is active. GSR defaults to active-High but can be inverted by adding an inverter in front of the GSR input of the appropriate `STARTUP_architecture` symbol.

## Logic Table

Inputs		Outputs
D	C	Q
D	↑	D

## Design Entry Method

This design element is only for use in schematics.

## For More Information

See the [Spartan-6 FPGA User Documentation \(User Guides and Data Sheets\)](#).

## OFDE

### Macro: D Flip-Flop with Active-High Enable Output Buffers

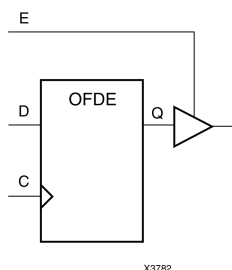

## Introduction

This is a single D flip-flop whose output is enabled by a 3-state buffer. The flip-flop data output (Q) is connected to the input of output buffer (OBUFE). The OBUFE output (O) is connected to an OPAD or IOPAD. The data on the data input (D) is loaded into the flip-flop during the Low-to-High clock (C) transition. When the active-High enable input (E) is High, the data on the flip-flop output (Q) appears on the OBUFE (O) output. When (E) is Low, the output is high impedance (Z state or Off).

This flip-flop is asynchronously cleared, outputs Low, when power is applied. For FPGA devices, power-on conditions are simulated when global set/reset (GSR) is active. GSR defaults to active-High but can be inverted by adding an inverter in front of the GSR input of the appropriate `STARTUP_architecture` symbol.

## Logic Table

Inputs			Output
E	D	C	O
0	X	X	Z
1	Dn	↑	Dn

## Design Entry Method

This design element is only for use in schematics.

## For More Information

See the [Spartan-6 FPGA User Documentation \(User Guides and Data Sheets\)](#).

## OFDE\_1

### Macro: D Flip-Flop with Active-High Enable Output Buffer and Inverted Clock

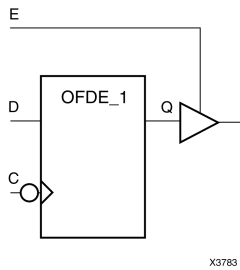

## Introduction

This design element and its output buffer are located in an input/output block (IOB). The data output of the flip-flop (Q) is connected to the input of an output buffer or OBUFE. The output of the OBUFE is connected to an OPAD or an IOPAD. The data on the data input (D) is loaded into the flip-flop on the High-to-Low clock (C) transition. When the active-High enable input (E) is High, the data on the flip-flop output (Q) appears on the (O) output. When (E) is Low, the output is high impedance (Z state or Off).

This flip-flop is asynchronously cleared, outputs Low, when power is applied. For FPGA devices, power-on conditions are simulated when global set/reset (GSR) is active. GSR defaults to active-High but can be inverted by adding an inverter in front of the GSR input of the appropriate `STARTUP_architecture` symbol.

## Logic Table

Inputs			Outputs
E	D	C	O
0	X	X	Z
1	D	↓	D

## Design Entry Method

This design element is only for use in schematics.

## For More Information

See the [Spartan-6 FPGA User Documentation \(User Guides and Data Sheets\)](#).

## OFDE16

### Macro: 16-Bit D Flip-Flop with Active-High Enable Output Buffers

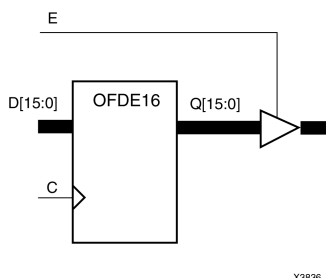

## Introduction

This is a multiple D flip-flop whose outputs are enabled by 3-state buffers. The flip-flop data outputs (Q) are connected to the inputs of output buffers (OBUFE). The OBUFE outputs (O) are connected to OPADs or IOPADs. The data on the data inputs (D) is loaded into the flip-flops during the Low-to-High clock (C) transition. When the active-High enable inputs (E) are High, the data on the flip-flop outputs (Q) appears on the OBUFE outputs (O). When (E) is Low, outputs are high impedance (Z state or Off).

This flip-flop is asynchronously cleared, outputs Low, when power is applied. For FPGA devices, power-on conditions are simulated when global set/reset (GSR) is active. GSR defaults to active-High but can be inverted by adding an inverter in front of the GSR input of the appropriate *STARTUP\_architecture* symbol.

## Logic Table

Inputs			Outputs
E	D	C	O
0	X	X	Z
1	Dn	↑	Dn

## Design Entry Method

This design element is only for use in schematics.

## For More Information

See the [Spartan-6 FPGA User Documentation \(User Guides and Data Sheets\)](#).

## OFDE4

### Macro: 4-Bit D Flip-Flop with Active-High Enable Output Buffers

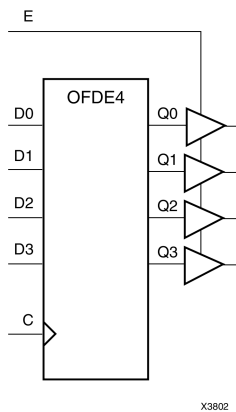

## Introduction

This is a multiple D flip-flop whose outputs are enabled by 3-state buffers. The flip-flop data outputs (Q) are connected to the inputs of output buffers (OBUFE). The OBUFE outputs (O) are connected to OPADs or IOPADs. The data on the data inputs (D) is loaded into the flip-flops during the Low-to-High clock (C) transition. When the active-High enable inputs (E) are High, the data on the flip-flop outputs (Q) appears on the OBUFE outputs (O). When (E) is Low, outputs are high impedance (Z state or Off).

This flip-flop is asynchronously cleared, outputs Low, when power is applied. For FPGA devices, power-on conditions are simulated when global set/reset (GSR) is active. GSR defaults to active-High but can be inverted by adding an inverter in front of the GSR input of the appropriate `STARTUP_architecture` symbol.

## Logic Table

Inputs			Outputs
E	D	C	O
0	X	X	Z
1	D <sub>n</sub>	↑	D <sub>n</sub>

## Design Entry Method

This design element is only for use in schematics.

## For More Information

See the [Spartan-6 FPGA User Documentation \(User Guides and Data Sheets\)](#).

## OFDE8

### Macro: 8-Bit D Flip-Flop with Active-High Enable Output Buffers

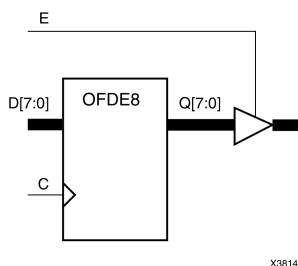

## Introduction

This is a multiple D flip-flop whose outputs are enabled by 3-state buffers. The flip-flop data outputs (Q) are connected to the inputs of output buffers (OBUFE). The OBUFE outputs (O) are connected to OPADs or IOPADs. The data on the data inputs (D) is loaded into the flip-flops during the Low-to-High clock (C) transition. When the active-High enable inputs (E) are High, the data on the flip-flop outputs (Q) appears on the OBUFE outputs (O). When (E) is Low, outputs are high impedance (Z state or Off).

This flip-flop is asynchronously cleared, outputs Low, when power is applied. For FPGA devices, power-on conditions are simulated when global set/reset (GSR) is active. GSR defaults to active-High but can be inverted by adding an inverter in front of the GSR input of the appropriate *STARTUP\_architecture* symbol.

## Logic Table

Inputs			Outputs
E	D	C	O
0	X	X	Z
1	Dn	↑	Dn

## Design Entry Method

This design element is only for use in schematics.

## For More Information

See the [Spartan-6 FPGA User Documentation \(User Guides and Data Sheets\)](#).



## OFDI

### Macro: Output D Flip-Flop (Asynchronous Preset)

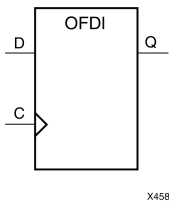

## Introduction

The design element is contained in an input/output block (IOB). The output (Q) of the (D) flip-flop is connected to an OPAD or an IOPAD. The data on the (D) input is loaded into the flip-flop during the Low-to-High clock (C) transition and appears at the output (Q).

This flip-flop is asynchronously preset, output High, when power is applied. For FPGA devices, power-on conditions are simulated when global set/reset (GSR) is active. GSR defaults to active-High but can be inverted by adding an inverter in front of the GSR input of the appropriate `STARTUP_architecture` symbol.

## Logic Table

Inputs		Outputs
D	C	Q
D	↑	D

## Design Entry Method

This design element is only for use in schematics.

## For More Information

See the [Spartan-6 FPGA User Documentation \(User Guides and Data Sheets\)](#).

## OFDI\_1

Macro: Output D Flip-Flop with Inverted Clock (Asynchronous Preset)

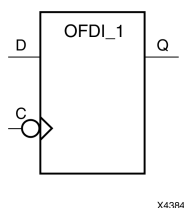

### Introduction

This design element exists in an input/output block (IOB). The (D) flip-flop output (Q) is connected to an OPAD or an IOPAD. The data on the (D) input is loaded into the flip-flop during the High-to-Low clock (C) transition and appears on the (Q) output.

This flip-flop is asynchronously preset, output High, when power is applied. For FPGA devices, power-on conditions are simulated when global set/reset (GSR) is active. GSR defaults to active-High but can be inverted by adding an inverter in front of the GSR input of the appropriate *STARTUP\_architecture* symbol.

### Logic Table

Inputs		Outputs
D	C	Q
D	↓	D

### Design Entry Method

This design element is only for use in schematics.

### For More Information

See the [Spartan-6 FPGA User Documentation \(User Guides and Data Sheets\)](#).

## OFDT

### Macro: D Flip-Flop with Active-Low 3-State Output Buffer

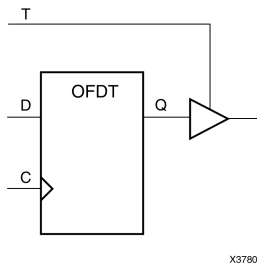

## Introduction

This design element is a single D flip-flops whose output is enabled by a 3-state buffer.

The data outputs (Q) of the flip-flops are connected to the inputs of output buffers (OBUFT). The outputs of the OBUFTs (O) are connected to OPADs or IOPADs. The data on the data inputs (D) is loaded into the flip-flops during the Low-to-High clock (C) transition. When the active-Low enable inputs (T) are Low, the data on the flip-flop outputs (Q) appears on the (O) outputs. When (T) is High, outputs are high impedance (Off).

This flip-flop is asynchronously cleared, outputs Low, when power is applied. For FPGA devices, power-on conditions are simulated when global set/reset (GSR) is active. GSR defaults to active-High but can be inverted by adding an inverter in front of the GSR input of the appropriate `STARTUP_architecture` symbol.

## Logic Table

Inputs			Outputs
T	D	C	O
1	X	X	Z
0	D	↑	D

## Design Entry Method

This design element is only for use in schematics.

## For More Information

See the [Spartan-6 FPGA User Documentation \(User Guides and Data Sheets\)](#).

## OFDT\_1

### Macro: D Flip-Flop with Active-Low 3-State Output Buffer and Inverted Clock

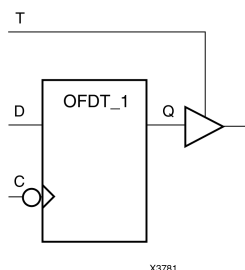

## Introduction

The design element and its output buffer are located in an input/output block (IOB). The flip-flop data output (Q) is connected to the input of an output buffer (OBUFT). The OBUFT output is connected to an OPAD or an IOPAD. The data on the data input (D) is loaded into the flip-flop on the High-to-Low clock (C) transition. When the active-Low enable input (T) is Low, the data on the flip-flop output (Q) appears on the (O) output. When (T) is High, the output is high impedance (Off).

This flip-flop is asynchronously cleared, outputs Low, when power is applied. For FPGA devices, power-on conditions are simulated when global set/reset (GSR) is active. GSR defaults to active-High but can be inverted by adding an inverter in front of the GSR input of the appropriate `STARTUP_architecture` symbol.

## Logic Table

Inputs			Outputs
T	D	C	O
1	X	X	Z
0	D	↓	D

## Design Entry Method

This design element is only for use in schematics.

## For More Information

See the [Spartan-6 FPGA User Documentation \(User Guides and Data Sheets\)](#).

# OFDT16

## Macro: 16-Bit D Flip-Flop with Active-Low 3-State Output Buffers

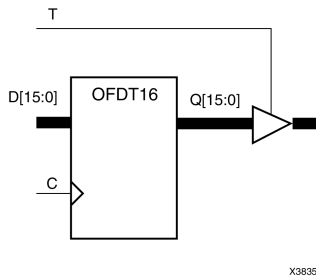

### Introduction

This design element is a multiple D flip-flop whose output are enabled by 3-state buffers.

The data outputs (Q) of the flip-flops are connected to the inputs of output buffers (OBUFT). The outputs of the OBUFTs (O) are connected to OPADs or IOPADs. The data on the data inputs (D) is loaded into the flip-flops during the Low-to-High clock (C) transition. When the active-Low enable inputs (T) are Low, the data on the flip-flop outputs (Q) appears on the (O) outputs. When (T) is High, outputs are high impedance (Off).

This flip-flop is asynchronously cleared, outputs Low, when power is applied. For FPGA devices, power-on conditions are simulated when global set/reset (GSR) is active. GSR defaults to active-High but can be inverted by adding an inverter in front of the GSR input of the appropriate *STARTUP\_architecture* symbol.

### Logic Table

Inputs			Outputs
T	D	C	O
1	X	X	Z
0	D	↑	D

### Design Entry Method

This design element is only for use in schematics.

### For More Information

See the [Spartan-6 FPGA User Documentation \(User Guides and Data Sheets\)](#).

## OFDT4

### Macro: 4-Bit D Flip-Flop with Active-Low 3-State Output Buffers

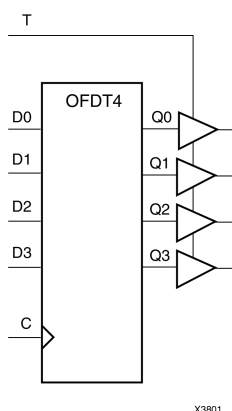

## Introduction

This design element is a multiple D flip-flop whose output are enabled by 3-state buffers.

The data outputs (Q) of the flip-flops are connected to the inputs of output buffers (OBUFT). The outputs of the OBUFTs (O) are connected to OPADs or IOPADs. The data on the data inputs (D) is loaded into the flip-flops during the Low-to-High clock (C) transition. When the active-Low enable inputs (T) are Low, the data on the flip-flop outputs (Q) appears on the (O) outputs. When (T) is High, outputs are high impedance (Off).

This flip-flop is asynchronously cleared, outputs Low, when power is applied. For FPGA devices, power-on conditions are simulated when global set/reset (GSR) is active. GSR defaults to active-High but can be inverted by adding an inverter in front of the GSR input of the appropriate `STARTUP_architecture` symbol.

## Logic Table

Inputs			Outputs
T	D	C	O
1	X	X	Z
0	D	↑	D

## Design Entry Method

This design element is only for use in schematics.

## For More Information

See the [Spartan-6 FPGA User Documentation \(User Guides and Data Sheets\)](#).

## OFDT8

### Macro: 8-Bit D Flip-Flop with Active-Low 3-State Output Buffers

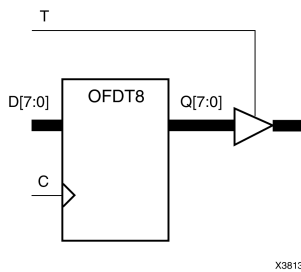

## Introduction

This design element is a multiple D flip-flop whose output are enabled by 3-state buffers.

The data outputs (Q) of the flip-flops are connected to the inputs of output buffers (OBUFT). The outputs of the OBUFTs (O) are connected to OPADs or IOPADs. The data on the data inputs (D) is loaded into the flip-flops during the Low-to-High clock (C) transition. When the active-Low enable inputs (T) are Low, the data on the flip-flop outputs (Q) appears on the (O) outputs. When (T) is High, outputs are high impedance (Off).

This flip-flop is asynchronously cleared, outputs Low, when power is applied. For FPGA devices, power-on conditions are simulated when global set/reset (GSR) is active. GSR defaults to active-High but can be inverted by adding an inverter in front of the GSR input of the appropriate `STARTUP_architecture` symbol.

## Logic Table

Inputs			Outputs
T	D	C	O
1	X	X	Z
0	D	↑	D

## Design Entry Method

This design element is only for use in schematics.

## For More Information

See the [Spartan-6 FPGA User Documentation \(User Guides and Data Sheets\)](#).

## OFDX

### Macro: Output D Flip-Flop with Clock Enable

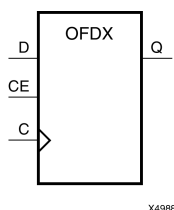

## Introduction

This design element is a single output D flip-flop. The (Q) output is connected to OPAD or IOPAD. The data on the (D) input is loaded into the flip-flop during the Low-to-High clock (C) transition and appears on the (Q) output. When (CE) is Low, the flip-flop output does not change.

This flip-flop is asynchronously cleared, outputs Low, when power is applied. For FPGA devices, power-on conditions are simulated when global set/reset (GSR) is active. GSR defaults to active-High but can be inverted by adding an inverter in front of the GSR input of the appropriate *STARTUP\_architecture* symbol.

## Logic Table

Inputs			Outputs
CE	D	C	Q
1	Dn	↑	Dn
0	X	X	No change

## Design Entry Method

This design element is only for use in schematics.

## For More Information

See the [Spartan-6 FPGA User Documentation \(User Guides and Data Sheets\)](#).



## OFDX\_1

### Macro: Output D Flip-Flop with Inverted Clock and Clock Enable

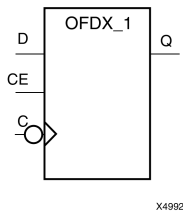

## Introduction

The design element is located in an input/output block (IOB). The output (Q) of the (D) flip-flop is connected to an OPAD or an IOPAD. The data on the (D) input is loaded into the flip-flop during the High-to-Low clock (C) transition and appears on the (Q) output. When the (CE) pin is Low, the output (Q) does not change.

This flip-flop is asynchronously cleared, outputs Low, when power is applied. For FPGA devices, power-on conditions are simulated when global set/reset (GSR) is active. GSR defaults to active-High but can be inverted by adding an inverter in front of the GSR input of the appropriate *STARTUP\_architecture* symbol.

## Logic Table

Inputs			Outputs
CE	D	C	Q
1	D	↓	D
0	X	X	No Change

## Design Entry Method

This design element is only for use in schematics.

## For More Information

See the [Spartan-6 FPGA User Documentation \(User Guides and Data Sheets\)](#).

## OFDX16

### Macro: 16-Bit Output D Flip-Flop with Clock Enable

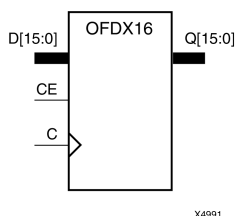

## Introduction

This design element is a multiple output D flip-flop. The (Q) output is connected to OPAD or IOPAD. The data on the (D) input is loaded into the flip-flop during the Low-to-High clock (C) transition and appears on the (Q) output. When (CE) is Low, the flip-flop output does not change.

This flip-flop is asynchronously cleared, outputs Low, when power is applied. For FPGA devices, power-on conditions are simulated when global set/reset (GSR) is active. GSR defaults to active-High but can be inverted by adding an inverter in front of the GSR input of the appropriate `STARTUP_architecture` symbol.

## Logic Table

Inputs			Outputs
CE	D	C	Q
1	Dn	↑	Dn
0	X	X	No change

## Design Entry Method

This design element is only for use in schematics.

## For More Information

See the [Spartan-6 FPGA User Documentation \(User Guides and Data Sheets\)](#).

## OFDX4

### Macro: 4-Bit Output D Flip-Flop with Clock Enable

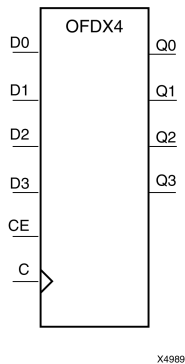

## Introduction

This design element is a multiple output D flip-flop. The (Q) output is connected to OPAD or IOPAD. The data on the (D) input is loaded into the flip-flop during the Low-to-High clock (C) transition and appears on the (Q) output. When (CE) is Low, the flip-flop output does not change.

This flip-flop is asynchronously cleared, outputs Low, when power is applied. For FPGA devices, power-on conditions are simulated when global set/reset (GSR) is active. GSR defaults to active-High but can be inverted by adding an inverter in front of the GSR input of the appropriate *STARTUP\_architecture* symbol.

## Logic Table

Inputs			Outputs
CE	D	C	Q
1	Dn	↑	Dn
0	X	X	No change

## Design Entry Method

This design element is only for use in schematics.

## For More Information

See the [Spartan-6 FPGA User Documentation \(User Guides and Data Sheets\)](#).

## OFDX8

### Macro: 8-Bit Output D Flip-Flop with Clock Enable

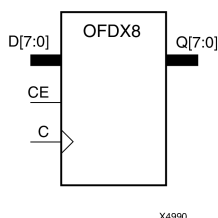

## Introduction

This design element is a multiple output D flip-flop. The (Q) output is connected to OPAD or IOPAD. The data on the (D) input is loaded into the flip-flop during the Low-to-High clock (C) transition and appears on the (Q) output. When (CE) is Low, the flip-flop output does not change.

This flip-flop is asynchronously cleared, outputs Low, when power is applied. For FPGA devices, power-on conditions are simulated when global set/reset (GSR) is active. GSR defaults to active-High but can be inverted by adding an inverter in front of the GSR input of the appropriate `STARTUP_architecture` symbol.

## Logic Table

Inputs			Outputs
CE	D	C	Q
1	Dn	↑	Dn
0	X	X	No change

## Design Entry Method

This design element is only for use in schematics.

## For More Information

See the [Spartan-6 FPGA User Documentation \(User Guides and Data Sheets\)](#).

## OFDXI

Macro: Output D Flip-Flop with Clock Enable (Asynchronous Preset)

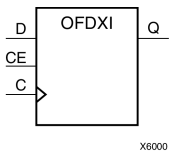

### Introduction

The design element is contained in an input/output block (IOB). The output (Q) of the D flip-flop is connected to an OPAD or an IOPAD. The data on the (D) input is loaded into the flip-flop during the Low-to-High clock (C) transition and appears at the output (Q). When (CE) is Low, the output does not change.

This flip-flop is asynchronously preset, output High, when power is applied. For FPGA devices, power-on conditions are simulated when global set/reset (GSR) is active. GSR defaults to active-High but can be inverted by adding an inverter in front of the GSR input of the appropriate *STARTUP\_architecture* symbol.

### Logic Table

Inputs			Outputs
CE	D	C	Q
1	D	↑	D
0	X	X	No Change

### Design Entry Method

This design element is only for use in schematics.

### For More Information

See the [Spartan-6 FPGA User Documentation \(User Guides and Data Sheets\)](#).

## OFDXI\_1

Macro: Output D Flip-Flop with Inverted Clock and Clock Enable (Asynchronous Preset)

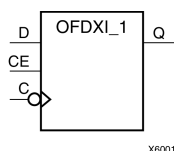

### Introduction

The design element is located in an input/output block (IOB). The D flip-flop output (Q) is connected to an OPAD or an IOPAD. The data on the D input is loaded into the flip-flop during the High-to-Low clock (C) transition and appears on the Q output. When CE is Low, the output (Q) does not change.

This flip-flop is asynchronously preset, output High, when power is applied. For FPGA devices, power-on conditions are simulated when global set/reset (GSR) is active. GSR defaults to active-High but can be inverted by adding an inverter in front of the GSR input of the appropriate *STARTUP\_architecture* symbol.

### Logic Table

Inputs			Outputs
CE	D	C	Q
1	D	↓	D
0	X	X	No Change

### Design Entry Method

This design element is only for use in schematics.

### For More Information

See the [Spartan-6 FPGA User Documentation \(User Guides and Data Sheets\)](#).

## OR12

### Macro: 12-Input OR Gate with Non-Inverted Inputs

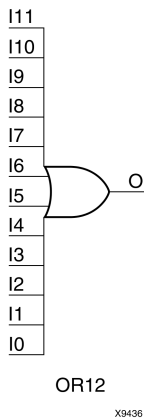

### Introduction

OR elements implement logical disjunction. A High output (1) results if one or more inputs are HIGH (1). A LOW output (0) results only if all inputs are Low (0).

OR functions of up to five inputs are available in any combination of inverting and non-inverting inputs. OR functions of six to nine inputs, 12 inputs, and 16 inputs are available with only non-inverting inputs. To invert some or all inputs, use external inverters. Because each input uses a CLB resource, replace functions with unused inputs with functions having the necessary number of inputs.

### Logic Table

Input	Output
I0 ... Iz	O
Any input is 1	1
All inputs are 0	0

### Design Entry Method

This design element is only for use in schematics.

### For More Information

See the [Spartan-6 FPGA User Documentation \(User Guides and Data Sheets\)](#).

## OR16

### Macro: 16-Input OR Gate with Non-Inverted Inputs

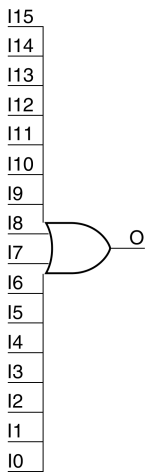

OR16

X9437

## Introduction

OR elements implement logical disjunction. A High output (1) results if one or more inputs are HIGH (1). A LOW output (0) results only if all inputs are Low (0).

OR functions of up to five inputs are available in any combination of inverting and non-inverting inputs. OR functions of six to nine inputs, 12 inputs, and 16 inputs are available with only non-inverting inputs. To invert some or all inputs, use external inverters. Because each input uses a CLB resource, replace functions with unused inputs with functions having the necessary number of inputs.

## Logic Table

Input	Output
I0 ... Iz	O
Any input is 1	1
All inputs are 0	0

## Design Entry Method

This design element is only for use in schematics.

## For More Information

See the [Spartan-6 FPGA User Documentation \(User Guides and Data Sheets\)](#).



## OR2

### Primitive: 2-Input OR Gate with Non-Inverted Inputs

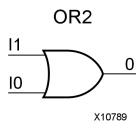

## Introduction

OR elements implement logical disjunction. A High output (1) results if one or more inputs are HIGH (1). A LOW output (0) results only if all inputs are Low (0).

OR functions of up to five inputs are available in any combination of inverting and non-inverting inputs. OR functions of six to nine inputs, 12 inputs, and 16 inputs are available with only non-inverting inputs. To invert some or all inputs, use external inverters. Because each input uses a CLB resource, replace functions with unused inputs with functions having the necessary number of inputs.

## Logic Table

Input	Output
I0 ... Iz	0
Any input is 1	1
All inputs are 0	0

## Design Entry Method

This design element is only for use in schematics.

## For More Information

See the [Spartan-6 FPGA User Documentation \(User Guides and Data Sheets\)](#).

## OR2B1

### Primitive: 2-Input OR Gate with 1 Inverted and 1 Non-Inverted Inputs

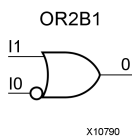

## Introduction

OR elements implement logical disjunction. A High output (1) results if one or more inputs are HIGH (1). A LOW output (0) results only if all inputs are Low (0).

OR functions of up to five inputs are available in any combination of inverting and non-inverting inputs. OR functions of six to nine inputs, 12 inputs, and 16 inputs are available with only non-inverting inputs. To invert some or all inputs, use external inverters. Because each input uses a CLB resource, replace functions with unused inputs with functions having the necessary number of inputs.

## Design Entry Method

This design element is only for use in schematics.

## For More Information

See the [Spartan-6 FPGA User Documentation \(User Guides and Data Sheets\)](#).

## OR2B2

### Primitive: 2-Input OR Gate with Inverted Inputs

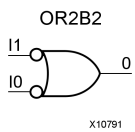

## Introduction

OR elements implement logical disjunction. A High output (1) results if one or more inputs are HIGH (1). A LOW output (0) results only if all inputs are Low (0).

OR functions of up to five inputs are available in any combination of inverting and non-inverting inputs. OR functions of six to nine inputs, 12 inputs, and 16 inputs are available with only non-inverting inputs. To invert some or all inputs, use external inverters. Because each input uses a CLB resource, replace functions with unused inputs with functions having the necessary number of inputs.

## Design Entry Method

This design element is only for use in schematics.

## For More Information

See the [Spartan-6 FPGA User Documentation \(User Guides and Data Sheets\)](#).

## OR2L

Primitive: Two input OR gate implemented in place of a Slice Latch

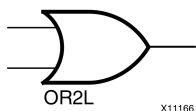

### Introduction

This element allows the specification of a configurable Slice Latch to take the function of a two input OR gate (see Logic Table). The use of this element can reduce logic levels and increase logic density of the part by trading off register/latch resources for logic. Xilinx suggests caution when using this component as it can affect register packing and density since specifying one or more AND2B1L or OR2L components in a Slice disallows the use of the remaining registers and latches.

### Logic Table

Inputs		Outputs
DI	SRI	O
0	0	0
0	1	1
1	0	1
1	1	1

### Port Descriptions

Port	Direction	Width	Function
O	Output	1	Output of the OR gate.
DI	Input	1	Active high input that is generally connected to sourcing LUT located in the same Slice.
SRI	Input	1	Active low input that is generally source from outside of the Slice. <b>Note</b> To allow more than one AND2B1L or OR2B1L to be packed into a single Slice, a common signal must be connected to this input.

### Design Entry Method

This design element is only for use in schematics.

### For More Information

- See the [Spartan-6 FPGA Configurable Logic Block User Guide \(UG384\)](#).
- See the [Spartan-6 FPGA Data Sheet: DC and Switching Characteristics \(DS162\)](#).

## OR3

### Primitive: 3-Input OR Gate with Non-Inverted Inputs

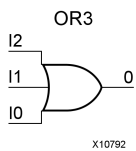

## Introduction

OR elements implement logical disjunction. A High output (1) results if one or more inputs are HIGH (1). A LOW output (0) results only if all inputs are Low (0).

OR functions of up to five inputs are available in any combination of inverting and non-inverting inputs. OR functions of six to nine inputs, 12 inputs, and 16 inputs are available with only non-inverting inputs. To invert some or all inputs, use external inverters. Because each input uses a CLB resource, replace functions with unused inputs with functions having the necessary number of inputs.

## Logic Table

Input	Output
I0 ... Iz	0
Any input is 1	1
All inputs are 0	0

## Design Entry Method

This design element is only for use in schematics.

## For More Information

See the [Spartan-6 FPGA User Documentation \(User Guides and Data Sheets\)](#).

## OR3B1

Primitive: 3-Input OR Gate with 1 Inverted and 2 Non-Inverted Inputs

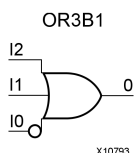

### Introduction

OR elements implement logical disjunction. A High output (1) results if one or more inputs are HIGH (1). A LOW output (0) results only if all inputs are Low (0).

OR functions of up to five inputs are available in any combination of inverting and non-inverting inputs. OR functions of six to nine inputs, 12 inputs, and 16 inputs are available with only non-inverting inputs. To invert some or all inputs, use external inverters. Because each input uses a CLB resource, replace functions with unused inputs with functions having the necessary number of inputs.

### Design Entry Method

This design element is only for use in schematics.

### For More Information

See the [Spartan-6 FPGA User Documentation \(User Guides and Data Sheets\)](#).

## OR3B2

Primitive: 3-Input OR Gate with 2 Inverted and 1 Non-Inverted Inputs

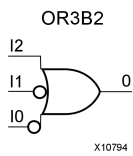

### Introduction

OR elements implement logical disjunction. A High output (1) results if one or more inputs are HIGH (1). A LOW output (0) results only if all inputs are Low (0).

OR functions of up to five inputs are available in any combination of inverting and non-inverting inputs. OR functions of six to nine inputs, 12 inputs, and 16 inputs are available with only non-inverting inputs. To invert some or all inputs, use external inverters. Because each input uses a CLB resource, replace functions with unused inputs with functions having the necessary number of inputs.

### Design Entry Method

This design element is only for use in schematics.

### For More Information

See the [Spartan-6 FPGA User Documentation \(User Guides and Data Sheets\)](#).

## OR3B3

### Primitive: 3-Input OR Gate with Inverted Inputs

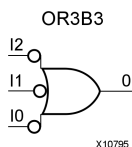

## Introduction

OR elements implement logical disjunction. A High output (1) results if one or more inputs are HIGH (1). A LOW output (0) results only if all inputs are Low (0).

OR functions of up to five inputs are available in any combination of inverting and non-inverting inputs. OR functions of six to nine inputs, 12 inputs, and 16 inputs are available with only non-inverting inputs. To invert some or all inputs, use external inverters. Because each input uses a CLB resource, replace functions with unused inputs with functions having the necessary number of inputs.

## Design Entry Method

This design element is only for use in schematics.

## For More Information

See the [Spartan-6 FPGA User Documentation \(User Guides and Data Sheets\)](#).



## OR4

### Primitive: 4-Input OR Gate with Non-Inverted Inputs

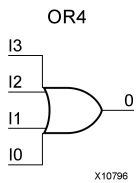

## Introduction

OR elements implement logical disjunction. A High output (1) results if one or more inputs are HIGH (1). A LOW output (0) results only if all inputs are Low (0).

OR functions of up to five inputs are available in any combination of inverting and non-inverting inputs. OR functions of six to nine inputs, 12 inputs, and 16 inputs are available with only non-inverting inputs. To invert some or all inputs, use external inverters. Because each input uses a CLB resource, replace functions with unused inputs with functions having the necessary number of inputs.

## Logic Table

Input	Output
I0 ... Iz	0
Any input is 1	1
All inputs are 0	0

## Design Entry Method

This design element is only for use in schematics.

## For More Information

See the [Spartan-6 FPGA User Documentation \(User Guides and Data Sheets\)](#).

## OR4B1

Primitive: 4-Input OR Gate with 1 Inverted and 3 Non-Inverted Inputs

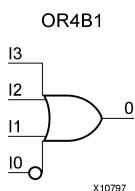

### Introduction

OR elements implement logical disjunction. A High output (1) results if one or more inputs are HIGH (1). A LOW output (0) results only if all inputs are Low (0).

OR functions of up to five inputs are available in any combination of inverting and non-inverting inputs. OR functions of six to nine inputs, 12 inputs, and 16 inputs are available with only non-inverting inputs. To invert some or all inputs, use external inverters. Because each input uses a CLB resource, replace functions with unused inputs with functions having the necessary number of inputs.

### Design Entry Method

This design element is only for use in schematics.

### For More Information

See the [Spartan-6 FPGA User Documentation \(User Guides and Data Sheets\)](#).

## OR4B2

Primitive: 4-Input OR Gate with 2 Inverted and 2 Non-Inverted Inputs

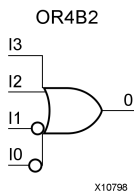

### Introduction

OR elements implement logical disjunction. A High output (1) results if one or more inputs are HIGH (1). A LOW output (0) results only if all inputs are Low (0).

OR functions of up to five inputs are available in any combination of inverting and non-inverting inputs. OR functions of six to nine inputs, 12 inputs, and 16 inputs are available with only non-inverting inputs. To invert some or all inputs, use external inverters. Because each input uses a CLB resource, replace functions with unused inputs with functions having the necessary number of inputs.

### Design Entry Method

This design element is only for use in schematics.

### For More Information

See the [Spartan-6 FPGA User Documentation \(User Guides and Data Sheets\)](#).

## OR4B3

### Primitive: 4-Input OR Gate with 3 Inverted and 1 Non-Inverted Inputs

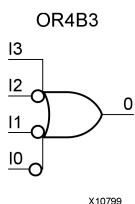

## Introduction

OR elements implement logical disjunction. A High output (1) results if one or more inputs are HIGH (1). A LOW output (0) results only if all inputs are Low (0).

OR functions of up to five inputs are available in any combination of inverting and non-inverting inputs. OR functions of six to nine inputs, 12 inputs, and 16 inputs are available with only non-inverting inputs. To invert some or all inputs, use external inverters. Because each input uses a CLB resource, replace functions with unused inputs with functions having the necessary number of inputs.

## Design Entry Method

This design element is only for use in schematics.

## For More Information

See the [Spartan-6 FPGA User Documentation \(User Guides and Data Sheets\)](#).

## OR4B4

### Primitive: 4-Input OR Gate with Inverted Inputs

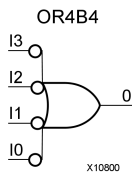

## Introduction

OR elements implement logical disjunction. A High output (1) results if one or more inputs are HIGH (1). A LOW output (0) results only if all inputs are Low (0).

OR functions of up to five inputs are available in any combination of inverting and non-inverting inputs. OR functions of six to nine inputs, 12 inputs, and 16 inputs are available with only non-inverting inputs. To invert some or all inputs, use external inverters. Because each input uses a CLB resource, replace functions with unused inputs with functions having the necessary number of inputs.

## Design Entry Method

This design element is only for use in schematics.

## For More Information

See the [Spartan-6 FPGA User Documentation \(User Guides and Data Sheets\)](#).

## OR5

### Primitive: 5-Input OR Gate with Non-Inverted Inputs

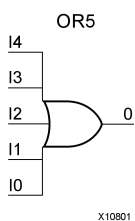

## Introduction

OR elements implement logical disjunction. A High output (1) results if one or more inputs are HIGH (1). A LOW output (0) results only if all inputs are Low (0).

OR functions of up to five inputs are available in any combination of inverting and non-inverting inputs. OR functions of six to nine inputs, 12 inputs, and 16 inputs are available with only non-inverting inputs. To invert some or all inputs, use external inverters. Because each input uses a CLB resource, replace functions with unused inputs with functions having the necessary number of inputs.

## Logic Table

Input	Output
I0 ... Iz	0
Any input is 1	1
All inputs are 0	0

## Design Entry Method

This design element is only for use in schematics.

## For More Information

See the [Spartan-6 FPGA User Documentation \(User Guides and Data Sheets\)](#).

## OR5B1

Primitive: 5-Input OR Gate with 1 Inverted and 4 Non-Inverted Inputs

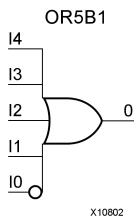

### Introduction

OR elements implement logical disjunction. A High output (1) results if one or more inputs are HIGH (1). A LOW output (0) results only if all inputs are Low (0).

OR functions of up to five inputs are available in any combination of inverting and non-inverting inputs. OR functions of six to nine inputs, 12 inputs, and 16 inputs are available with only non-inverting inputs. To invert some or all inputs, use external inverters. Because each input uses a CLB resource, replace functions with unused inputs with functions having the necessary number of inputs.

### Design Entry Method

This design element is only for use in schematics.

### For More Information

See the [Spartan-6 FPGA User Documentation \(User Guides and Data Sheets\)](#).

## OR5B2

Primitive: 5-Input OR Gate with 2 Inverted and 3 Non-Inverted Inputs

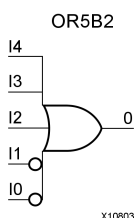

### Introduction

OR elements implement logical disjunction. A High output (1) results if one or more inputs are HIGH (1). A LOW output (0) results only if all inputs are Low (0).

OR functions of up to five inputs are available in any combination of inverting and non-inverting inputs. OR functions of six to nine inputs, 12 inputs, and 16 inputs are available with only non-inverting inputs. To invert some or all inputs, use external inverters. Because each input uses a CLB resource, replace functions with unused inputs with functions having the necessary number of inputs.

### Design Entry Method

This design element is only for use in schematics.

### For More Information

See the [Spartan-6 FPGA User Documentation \(User Guides and Data Sheets\)](#).



## OR5B3

### Primitive: 5-Input OR Gate with 3 Inverted and 2 Non-Inverted Inputs

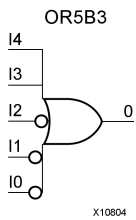

## Introduction

OR elements implement logical disjunction. A High output (1) results if one or more inputs are HIGH (1). A LOW output (0) results only if all inputs are Low (0).

OR functions of up to five inputs are available in any combination of inverting and non-inverting inputs. OR functions of six to nine inputs, 12 inputs, and 16 inputs are available with only non-inverting inputs. To invert some or all inputs, use external inverters. Because each input uses a CLB resource, replace functions with unused inputs with functions having the necessary number of inputs.

## Design Entry Method

This design element is only for use in schematics.

## For More Information

See the [Spartan-6 FPGA User Documentation \(User Guides and Data Sheets\)](#).

## OR5B4

Primitive: 5-Input OR Gate with 4 Inverted and 1 Non-Inverted Inputs

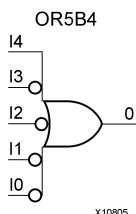

### Introduction

OR elements implement logical disjunction. A High output (1) results if one or more inputs are HIGH (1). A LOW output (0) results only if all inputs are Low (0).

OR functions of up to five inputs are available in any combination of inverting and non-inverting inputs. OR functions of six to nine inputs, 12 inputs, and 16 inputs are available with only non-inverting inputs. To invert some or all inputs, use external inverters. Because each input uses a CLB resource, replace functions with unused inputs with functions having the necessary number of inputs.

### Design Entry Method

This design element is only for use in schematics.

### For More Information

See the [Spartan-6 FPGA User Documentation \(User Guides and Data Sheets\)](#).

## OR5B5

### Primitive: 5-Input OR Gate with Inverted Inputs

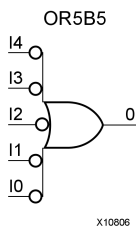

## Introduction

OR elements implement logical disjunction. A High output (1) results if one or more inputs are HIGH (1). A LOW output (0) results only if all inputs are Low (0).

OR functions of up to five inputs are available in any combination of inverting and non-inverting inputs. OR functions of six to nine inputs, 12 inputs, and 16 inputs are available with only non-inverting inputs. To invert some or all inputs, use external inverters. Because each input uses a CLB resource, replace functions with unused inputs with functions having the necessary number of inputs.

## Design Entry Method

This design element is only for use in schematics.

## For More Information

See the [Spartan-6 FPGA User Documentation \(User Guides and Data Sheets\)](#).

## OR6

### Macro: 6-Input OR Gate with Non-Inverted Inputs

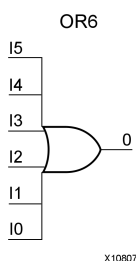

## Introduction

OR elements implement logical disjunction. A High output (1) results if one or more inputs are HIGH (1). A LOW output (0) results only if all inputs are Low (0).

OR functions of up to five inputs are available in any combination of inverting and non-inverting inputs. OR functions of six to nine inputs, 12 inputs, and 16 inputs are available with only non-inverting inputs. To invert some or all inputs, use external inverters. Because each input uses a CLB resource, replace functions with unused inputs with functions having the necessary number of inputs.

## Logic Table

Input	Output
I0 ... Iz	0
Any input is 1	1
All inputs are 0	0

## Design Entry Method

This design element is only for use in schematics.

## For More Information

See the [Spartan-6 FPGA User Documentation \(User Guides and Data Sheets\)](#).

## OR7

### Macro: 7-Input OR Gate with Non-Inverted Inputs

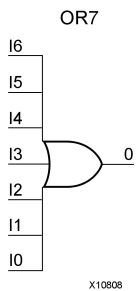

## Introduction

OR elements implement logical disjunction. A High output (1) results if one or more inputs are HIGH (1). A LOW output (0) results only if all inputs are Low (0).

OR functions of up to five inputs are available in any combination of inverting and non-inverting inputs. OR functions of six to nine inputs, 12 inputs, and 16 inputs are available with only non-inverting inputs. To invert some or all inputs, use external inverters. Because each input uses a CLB resource, replace functions with unused inputs with functions having the necessary number of inputs.

## Logic Table

Input	Output
I0 ... Iz	0
Any input is 1	1
All inputs are 0	0

## Design Entry Method

This design element is only for use in schematics.

## For More Information

See the [Spartan-6 FPGA User Documentation \(User Guides and Data Sheets\)](#).

## OR8

### Macro: 8-Input OR Gate with Non-Inverted Inputs

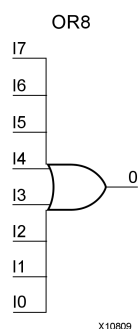

## Introduction

OR elements implement logical disjunction. A High output (1) results if one or more inputs are HIGH (1). A LOW output (0) results only if all inputs are Low (0).

OR functions of up to five inputs are available in any combination of inverting and non-inverting inputs. OR functions of six to nine inputs, 12 inputs, and 16 inputs are available with only non-inverting inputs. To invert some or all inputs, use external inverters. Because each input uses a CLB resource, replace functions with unused inputs with functions having the necessary number of inputs.

## Logic Table

Input	Output
I0 ... Iz	0
Any input is 1	1
All inputs are 0	0

## Design Entry Method

This design element is only for use in schematics.

## For More Information

See the [Spartan-6 FPGA User Documentation \(User Guides and Data Sheets\)](#).

## OR9

### Macro: 9-Input OR Gate with Non-Inverted Inputs

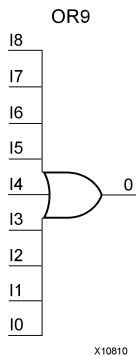

## Introduction

OR elements implement logical disjunction. A High output (1) results if one or more inputs are HIGH (1). A LOW output (0) results only if all inputs are Low (0).

OR functions of up to five inputs are available in any combination of inverting and non-inverting inputs. OR functions of six to nine inputs, 12 inputs, and 16 inputs are available with only non-inverting inputs. To invert some or all inputs, use external inverters. Because each input uses a CLB resource, replace functions with unused inputs with functions having the necessary number of inputs.

## Logic Table

Input	Output
I0 ... Iz	0
Any input is 1	1
All inputs are 0	0

## Design Entry Method

This design element is only for use in schematics.

## For More Information

See the [Spartan-6 FPGA User Documentation \(User Guides and Data Sheets\)](#).

## OSERDES2

Primitive: Dedicated IOB Output Serializer

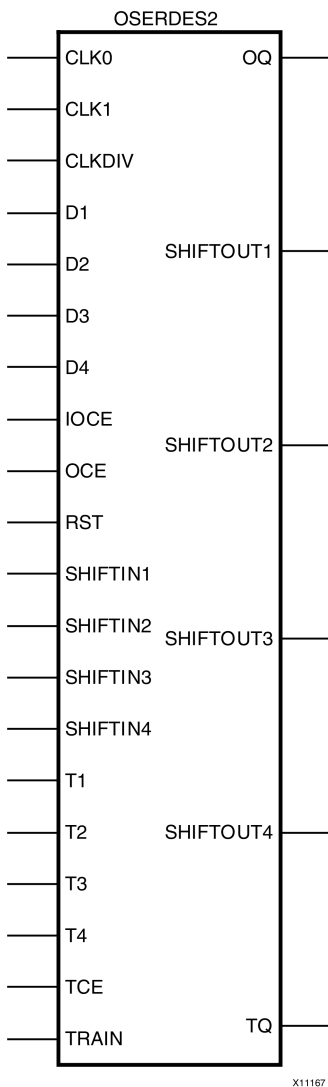

### Introduction

Each IOB contains an output serializer block that can be instantiated in a design by using the OSERDES2 primitive. OSERDES2 allows parallel-to-serial conversion with SerDes ratios of 2:1, 3:1, and 4:1. The SerDes ratio is the ratio between the high-speed I/O clock that is transmitting data, and the slower internal global clock used for processing the parallel data. For example, with an I/O clock running at 500 MHz to transmit data at 500 Mb/s, the OSERDES transfers four bits of data at one quarter of this rate (125 MHz) from the FPGA logic. When using differential outputs, the two OSERDES2 primitives associated with the two IOBs can be cascaded to allow higher SerDes ratios of 5:1, 6:1, 7:1 and 8:1.



## Port Descriptions

Port	Direction	Width	Function
CLKDIV	Input	1	Global clock network input. This is the clock for the fabric domain.
CLK0	Input	1	I/O clock network input. Optionally invertible. This is the primary clock input used when the clock doubler circuit is not engaged. See DATA_RATE attribute for more information.
CLK1	Input	1	IO Clock network input. Optionally Invertible. This secondary clock input is only used when the clock doubler is engaged.
D1 - D4	Input	1	Parallel data inputs.
IOCE	Input	1	Data strobe signal derived from BUFIO2 CE. Strokes data capture to be correctly timed with respect to the I/O and global clocks for the SerDes mode selected.
OCE	Input	1	Clock enable for data inputs.
OQ	Output	1	Data path output to pad or IODELAY2.
RST	Input	1	Shared data, 3-state reset pin. Asynchronous only.
SHIFTIN1	Input	1	Cascade data input signal (dummy in Master). Used for DATA_WIDTHs greater than four.
SHIFTIN2	Input	1	Cascade 3-state input signal (dummy in master). Used for DATA_WIDTHs greater than 4.
SHIFTIN3	Input	1	Differential data input Signals (dummy in Slave).
SHIFTIN4	Input	1	Differential 3-state input signal (dummy in Slave)
SHIFTOUT1	Output	1	Cascade data output signal (dummy in Slave). Used for DATA_WIDTHs greater than four.
SHIFTOUT2	Output	1	Cascade 3-state output signal (dummy in Slave). Used for DATA_WIDTHs greater than 4.
SHIFTOUT3	Output	1	Differential data output signals (dummy in Master).
SHIFTOUT4	Output	1	Differential 3-state output signal (dummy in Master)
TCE	Input	1	Clock enable for 3-state inputs.
TQ	Output	1	3-state path output to pad or IODELAY2.
TRAIN	Input	1	Enable use of the training pattern. The train function is a means of specifying a fixed output pattern that can be used to calibrate the receiver of the signal. This port allows the FPGA logic to control whether the output is that fixed pattern or the input data from the pins.
T1 - T4	Input	1	3-state control inputs.

## Design Entry Method

This design element can be used in schematics.

## Available Attributes

Attribute	Data Type	Allowed Values	Default	Description
BYPASS_GCLK_FF	Boolean	FALSE, TRUE	FALSE	Bypass CLKDIV synchronization registers.
DATA_RATE_OQ	String	"DDR", "SDR"	"DDR"	Data rate setting. The DDR clock can be supplied by separate I/O clocks or by a single I/O clock. If two clocks are supplied, they must be approximately 180 out of phase.
DATA_RATE_OT	String	"DDR", "BUF", "SDR"	"DDR"	3-state data rate setting. The DDR clock can be supplied by separate I/O clocks or by a single I/O clock. If two clocks are supplied, they must be approximately 180 out of phase.
DATA_WIDTH	Integer	2, 1, 3, 4, 5, 6, 7, 8	2	Data width. Determines the parallel data input width of the parallel-to-serial converter. Values greater than four are only valid when two OSERDES2 blocks are cascaded. In this case, the same value should be applied to both the master and slave blocks.
OUTPUT_MODE	String	"SINGLE_ENDED", "DIFFERENTIAL"	"SINGLE_ENDED"	Output Mode.
SERDES_MODE	String	"MASTER", "SLAVE"	"MASTER"	Indicates whether OSERDES is being used alone, or as a Master or Slave when two OSERDES2 blocks are cascaded.
TRAIN_PATTERN	Integer	0, 1, 2, 3, 4, 5, 6, 7, 8, 9, 10, 11, 12, 13, 14, 15	0	Defines training pattern to be sent when TRAIN port is active.

## For More Information

- See the [Spartan-6 FPGA SelectIO Resources User Guide \(UG381\)](#).
- See the [Spartan-6 FPGA Data Sheet: DC and Switching Characteristics \(DS162\)](#).



## Introduction

This design element is intended for use in conjunction with other resources located in the FPGA, such as the RocketIO™ transceiver, block RAMs, and various clocking resources. To implement a PCI EXPRESS® design using PCIE\_A1, designers must use the CORE Generator™ software tool (part of the ISE® Design Suite) to create a LogiCORE™ IP core for PCI EXPRESS designs. The LogiCORE IP instantiates the PCIE\_A1 software primitive, connects the interfaces to the correct FPGA resources, sets all attributes, and presents a simple, user-friendly interface.

## Design Entry Method

To instantiate this component, use the PCI EXPRESS® core or an associated core containing the component. Xilinx does not recommend direct instantiation of this component.

This design element can be used in schematics.

## For More Information

- See the [Spartan-6 FPGA RocketIO GTP Transceivers User Guide \(UG386\)](#).
- See the [LogiCORE™ IP Spartan-6 FPGA Integrated Endpoint Block v1.1 for PCI EXPRESS® User Guide \(UG654\)](#).
- See the [Spartan-6 FPGA Data Sheet: DC and Switching Characteristics \(DS162\)](#).

# PLL\_BASE

## Primitive: Basic Phase Locked Loop Clock Circuit

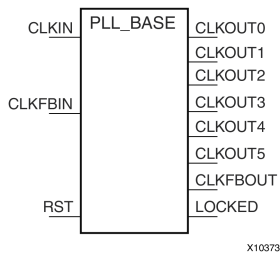

## Introduction

This design element is a direct sub-set of the PLL\_ADV design element, an embedded Phase Locked Loop clock circuit that provides added capabilities for clock synthesis and management both within the FPGA and in circuits external to the FPGA. The PLL\_BASE is provided in order to ease the integration for most PLL clocking circuits. However, this primitive does not contain all of the functionality that the PLL can possibly provide. This component allows the input clock to be phase shifted, multiplied and divided, and supports other features, such as modification of the duty cycle and jitter filtering.

## Port Descriptions

Port	Direction	Width	Function
Clock Outputs/Inputs			
CLKOUT0-5	Output	1	One of six phase controlled output clocks from the PLL.
CLKFBOUT	Output	1	Dedicated PLL feedback output used to determine how the PLL compensates clock network delay. Depending on the type of compensation desired, this output might or might not need to be connected.
CLKIN	Input	1	Clock source input to the PLL. This pin can be driven by a dedicated clock pin to the FPGA, a DCM output clock pin, or a BUFG output.
CLKFBIN	Input	1	Clock feedback input. This pin should only be sourced from the CLKFBOUT port.
Status Outputs/Control Inputs			
LOCKED	Output	1	Asynchronous output from the PLL that provides you with an indication the PLL has achieved phase alignment and is ready for operation.
RST	Input	1	Asynchronous reset of the PLL.

## Design Entry Method

This design element can be used in schematics.

## Available Attributes

Attribute	Data Type	Allowed Values	Default	Description
COMPENSATION	String	"SYSTEM_SYNCHRONOUS", "SOURCE_SYNCHRONOUS"	"SYSTEM_SYNCHRONOUS"	Specifies the PLL phase compensation for the incoming clock. SYSTEM_SYNCHRONOUS attempts to compensate all clock delay while SOURCE_SYNCHRONOUS is used when a clock is provided with data and thus phased with the clock.
BANDWIDTH	String	"HIGH", "LOW", "OPTIMIZED"	"OPTIMIZED"	Specifies the PLL programming algorithm affecting the jitter, phase margin and other characteristics of the PLL.
CLKOUT0_DIVIDE, CLKOUT1_DIVIDE, CLKOUT2_DIVIDE, CLKOUT3_DIVIDE, CLKOUT4_DIVIDE, CLKOUT5_DIVIDE	Integer	1 to 128	1	Specifies the amount to divide the associated CLKOUT clock output if a different frequency is desired. This number in combination with the FBCLKOUT_MULT value determines the output frequency.
CLKOUT0_PHASE, CLKOUT1_PHASE, CLKOUT2_PHASE, CLKOUT3_PHASE, CLKOUT4_PHASE, CLKOUT5_PHASE	Real	0.01 to 360.0	0.0	Allows specification of the output phase relationship of the associated CLKOUT clock output in number of degrees offset (for instance, 90 indicates a 90 degree offset or 1/4 cycle phase offset while 180 indicates a 180 degree offset or 1/2 cycle phase offset).
CLKOUT0_DUTY_CYCLE, CLKOUT1_DUTY_CYCLE, CLKOUT2_DUTY_CYCLE, CLKOUT3_DUTY_CYCLE, CLKOUT4_DUTY_CYCLE, CLKOUT5_DUTY_CYCLE,	Real	0.01 to 0.99	0.50	Specifies the Duty Cycle of the associated CLKOUT clock output in percentage (i.e. 0.50 generates a 50% duty cycle).
CLKFBOUT_MULT	Integer	1 to 64	1	Specifies the amount to multiply all CLKOUT clock outputs if a different frequency is desired. This number in combination with the associated CLKOUT#_DIVIDE value determines the output frequency.
DIVCLK_DIVIDE	Integer	1 to 52	1	Specifies the division ratio for all output clocks.
CLKFBOUT_PHASE	Real	0.0 to 360	0.0	Specifies the phase offset in degrees of the clock feedback output.
CLK_FEEDBACK	String	"CLKFBOUT", "CLKOUT0"	"CLKFBOUT"	Specifies the clock source to drive CLKFB_IN. Refer to <i>Spartan®-6 FPGA Clocking Resources User Guiden (UG382)</i> for correct usage of feedback resources and calculating VCO frequency.

Attribute	Data Type	Allowed Values	Default	Description
REF_JITTER	Real	0.000 to 0.999	0.100	The reference clock jitter is specified in terms of the UI which is a percentage of the reference clock. The number provided should be the maximum peak to peak value on the input clock.
CLKIN_PERIOD	Real	1.000 to 52.630	None	Specified the input period in ns to the PLL CLKIN input.

## For More Information

See the [Spartan-6 FPGA User Documentation \(User Guides and Data Sheets\)](#).

## POST\_CRC\_INTERNAL

Primitive: Post-configuration CRC error detection

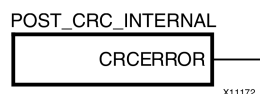

### Introduction

This primitive provides fabric access to post CRC error. This new primitive is added to provide more flexibility of POST\_CRC usage. It is also the only access to POST CRC status when CRC\_EXTSTAT\_DISABLE is activated.

### Port Descriptions

Port	Direction	Width	Function
CRCERROR	Output	1	Post-configuration CRC error

### Design Entry Method

This design element can be used in schematics.

### For More Information

- See the [Spartan-6 FPGA Configuration User Guide \(UG380\)](#).
- See the [Spartan-6 FPGA Data Sheet: DC and Switching Characteristics \(DS162\)](#).



## PULLDOWN

Primitive: Resistor to GND for Input Pads, Open-Drain, and 3-State Outputs

PULLDOWN

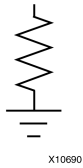

### Introduction

This resistor element is connected to input, output, or bidirectional pads to guarantee a logic Low level for nodes that might float.

### Port Descriptions

Port	Direction	Width	Function
O	Output	1	Pulldown output (connect directly to top level port)

### Design Entry Method

This design element can be used in schematics.

This element can be connected to a net in the following locations on a top-level schematic file:

- A net connected to an input IO Marker.
- A net connected to both an output IO Marker and 3-statable IO element, such as an OBUFT.

### For More Information

- See the [Spartan-6 FPGA SelectIO Resources User Guide \(UG381\)](#).
- See the [Spartan-6 FPGA Data Sheet: DC and Switching Characteristics \(DS162\)](#).

## PULLUP

Primitive: Resistor to VCC for Input PADs, Open-Drain, and 3-State Outputs

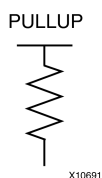

### Introduction

This design element allows for an input, 3-state output or bi-directional port to be driven to a weak high value when not being driven by an internal or external source. This element establishes a High logic level for open-drain elements and macros when all the drivers are off.

### Port Descriptions

Port	Direction	Width	Function
O	Output	1	Pullup output (connect directly to top level port)

### Design Entry Method

This design element can be used in schematics.

This element can be connected to a net in the following locations on a top-level schematic file:

- A net connected to an input IO Marker
- A net connected to both an output IO Marker and 3-statable IO element, such as an OBUFT.

### For More Information

- See the [Spartan-6 FPGA SelectIO Resources User Guide \(UG381\)](#).
- See the [Spartan-6 FPGA Data Sheet: DC and Switching Characteristics \(DS162\)](#).

# RAM128X1D

Primitive: 128-Deep by 1-Wide Dual Port Random Access Memory (Select RAM)

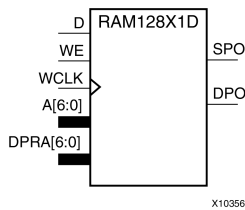

## Introduction

This design element is a 128-bit deep by 1-bit wide random access memory and has a read/write port that writes the value on the D input data pin when the write enable (WE) is high to the location specified by the A address bus. This happens shortly after the rising edge of the WCLK and that same value is reflected in the data output SPO. When WE is low, an asynchronous read is initiated in which the contents of the memory location specified by the A address bus is output asynchronously to the SPO output. The read port can perform asynchronous read access of the memory by changing the value of the address bus DPRA, and by outputting that value to the DPO data output.

## Port Descriptions

Port	Direction	Width	Function
SPO	Output	1	Read/Write port data output addressed by A
DPO	Output	1	Read port data output addressed by DPRA
D	Input	1	Write data input addressed by A
A	Input	7	Read/Write port address bus
DPRA	Input	7	Read port address bus
WE	Input	1	Write Enable
WCLK	Input	1	Write clock (reads are asynchronous)

If instantiated, the following connections should be made to this component:

- Tie the WCLK input to the desired clock source, the D input to the data source to be stored and the DPO output to an FDCE D input or other appropriate data destination.
- Optionally, the SPO output can also be connected to the appropriate data destination or else left unconnected.
- The WE clock enable pin should be connected to the proper write enable source in the design.
- The 7-bit A bus should be connected to the source for the read/write addressing and the 7-bit DPRA bus should be connected to the appropriate read address connections.
- An optional INIT attribute consisting of a 128-bit Hexadecimal value can be specified to indicate the initial contents of the RAM.

If left unspecified, the initial contents default to all zeros.

## Design Entry Method

This design element can be used in schematics.

## Available Attributes

Attribute	Type	Allowed Values	Default	Description
INIT	Hexadecimal	Any 128-Bit Value	All zeros	Specifies the initial contents of the RAM.

## For More Information

- See the [Spartan-6 FPGA Configurable Logic Block User Guide \(UG384\)](#).
- See the [Spartan-6 FPGA Data Sheet: DC and Switching Characteristics \(DS162\)](#).

# RAM16X1D

## Primitive: 16-Deep by 1-Wide Static Dual Port Synchronous RAM

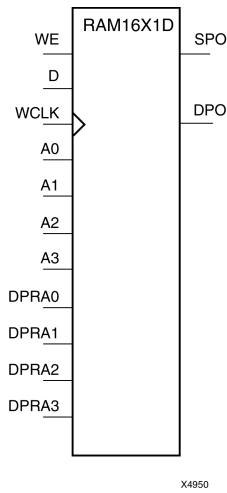

### Introduction

This element is a 16-word by 1-bit static dual port random access memory with synchronous write capability. The device has two address ports: the read address (DPRA3:DPRA0) and the write address (A3:A0). These two address ports are asynchronous. The read address controls the location of the data driven out of the output pin (DPO), and the write address controls the destination of a valid write transaction. When the write enable (WE) is Low, transitions on the write clock (WCLK) are ignored and data stored in the RAM is not affected.

When WE is High, any positive transition on (WCLK) loads the data on the data input (D) into the word selected by the 4-bit write address. For predictable performance, write address and data inputs must be stable before a Low-to-High (WCLK) transition. This RAM block assumes an active-High (WCLK). (WCLK) can be active-High or active-Low. Any inverter placed on the (WCLK) input net is absorbed into the block.

The SPO output reflects the data in the memory cell addressed by A3:A0. The DPO output reflects the data in the memory cell addressed by DPRA3:DPRA0.

**Note** The write process is not affected by the address on the read address port.

You can use the INIT attribute to directly specify an initial value. The value must be a hexadecimal number, for example, INIT=ABAC. If the INIT attribute is not specified, the RAM is initialized with all zeros.

### Logic Table

Mode selection is shown in the following logic table:

Inputs			Outputs	
WE (mode)	WCLK	D	SPO	DPO
0 (read)	X	X	data_a	data_d
1 (read)	0	X	data_a	data_d
1 (read)	1	X	data_a	data_d
1 (write)	↑	D	D	data_d
1 (read)	↓	X	data_a	data_d

data\_a = word addressed by bits A3-A0  
 data\_d = word addressed by bits DPRA3-DPRA0

## Design Entry Method

This design element can be used in schematics.

### Available Attributes

Attribute	Data Type	Allowed Values	Default	Description
INIT	Hexadecimal	Any 16-Bit Value	All zeros.	Initializes RAMs, registers, and look-up tables.

### For More Information

See the [Spartan-6 FPGA User Documentation \(User Guides and Data Sheets\)](#).

# RAM16X1D\_1

Primitive: 16-Deep by 1-Wide Static Dual Port Synchronous RAM with Negative-Edge Clock

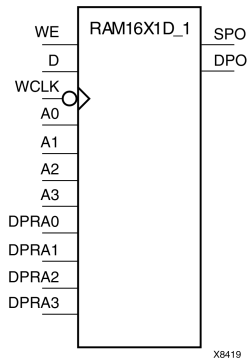

## Introduction

This is a 16-word by 1-bit static dual port random access memory with synchronous write capability and negative-edge clock. The device has two separate address ports: the read address (DPRA3:DPRA0) and the write address (A3:A0). These two address ports are asynchronous. The read address controls the location of the data driven out of the output pin (DPO), and the write address controls the destination of a valid write transaction.

When the write enable (WE) is set to Low, transitions on the write clock (WCLK) are ignored and data stored in the RAM is not affected. When (WE) is High, any negative transition on (WCLK) loads the data on the data input (D) into the word selected by the 4-bit write address. For predictable performance, write address and data inputs must be stable before a High-to-Low WCLK transition. This RAM block assumes an active-Low (WCLK). (WCLK) can be active-High or active-Low. Any inverter placed on the (WCLK) input net is absorbed into the block.

You can initialize RAM16X1D\_1 during configuration using the INIT attribute.

The SPO output reflects the data in the memory cell addressed by A3:A0. The DPO output reflects the data in the memory cell addressed by DPRA3:DPRA0.

**Note** The write process is not affected by the address on the read address port.

## Logic Table

Mode selection is shown in the following logic table:

Inputs			Outputs	
WE (mode)	WCLK	D	SPO	DPO
0 (read)	X	X	data_a	data_d
1 (read)	0	X	data_a	data_d
1 (read)	1	X	data_a	data_d
1 (write)	↓	D	D	data_d
1 (read)	↑	X	data_a	data_d

data\_a = word addressed by bits A3:A0  
 data\_d = word addressed by bits DPRA3:DPRA0

## Port Descriptions

Port	Direction	Width	Function
DPO	Output	1	Read-only 1-Bit data output
SPO	Output	1	R/W 1-Bit data output
A0	Input	1	R/W address[0] input
A1	Input	1	R/W address[1] input
A2	Input	1	R/W address[2] input
A3	Input	1	R/W address[3] input
D	Input	1	Write 1-Bit data input
DPRA0	Input	1	Read-only address[0] input
DPRA1	Input	1	Read-only address[1] input
DPRA2	Input	1	Read-only address[2] input
DPRA3	Input	1	Read-only address[3] input
WCLK	Input	1	Write clock input
WE	Input	1	Write enable input

## Design Entry Method

This design element can be used in schematics.

## Available Attributes

Attribute	Data Type	Allowed Values	Default	Description
INIT	Hexadecimal	Any 16-Bit Value	All zeros	Initializes RAMs, registers, and look-up tables.

## For More Information

See the [Spartan-6 FPGA User Documentation \(User Guides and Data Sheets\)](#).



# RAM16X1S

Primitive: 16-Deep by 1-Wide Static Synchronous RAM

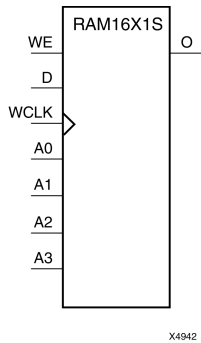

## Introduction

This element is a 16-word by 1-bit static random access memory with synchronous write capability. When the write enable (WE) is set Low, transitions on the write clock (WCLK) are ignored and data stored in the RAM is not affected. When WE is set High, any positive transition on WCLK loads the data on the data input (D) into the word selected by the 4-bit address (A3:A0). This RAM block assumes an active-High WCLK. However, WCLK can be active-High or active-Low. Any inverter placed on the WCLK input net is absorbed into the block.

The signal output on the data output pin (O) is the data that is stored in the RAM at the location defined by the values on the address pins. You can initialize RAM16X1S during configuration using the INIT attribute.

## Logic Table

Inputs			Outputs
WE(mode)	WCLK	D	O
0 (read)	X	X	Data
1 (read)	0	X	Data
1 (read)	1	X	Data
1 (write)	↑	D	D
1 (read)	↓	X	Data

Data = word addressed by bits A3:A0

## Design Entry Method

This design element can be used in schematics.

## Available Attributes

Attribute	Data Type	Allowed Values	Default	Description
INIT	Hexadecimal	Any 16-Bit Value	All zeros	Specifies initial contents of the RAM.

## For More Information

See the [Spartan-6 FPGA User Documentation \(User Guides and Data Sheets\)](#).

## RAM16X1S\_1

Primitive: 16-Deep by 1-Wide Static Synchronous RAM with Negative-Edge Clock

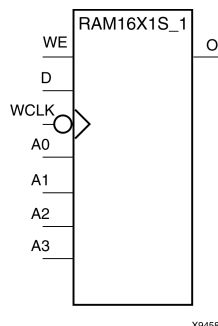

### Introduction

This element is a 16-word by 1-bit static random access memory with synchronous write capability and negative-edge clock. When the write enable (WE) is Low, transitions on the write clock (WCLK) are ignored and data stored in the RAM is not affected. When (WE) is High, any negative transition on (WCLK) loads the data on the data input (D) into the word selected by the 4-bit address (A3:A0). For predictable performance, address and data inputs must be stable before a High-to-Low WCLK transition. This RAM block assumes an active-Low (WCLK). However, (WCLK) can be active-High or active-Low. Any inverter placed on the (WCLK) input net is absorbed into the block.

The signal output on the data output pin (O) is the data that is stored in the RAM at the location defined by the values on the address pins.

You can initialize this element during configuration using the INIT attribute.

### Logic Table

Inputs			Outputs
WE(mode)	WCLK	D	O
0 (read)	X	X	Data
1 (read)	0	X	Data
1 (read)	1	X	Data
1 (write)	↓	D	D
1 (read)	↑	X	Data

Data = word addressed by bits A3:A0

### Design Entry Method

This design element can be used in schematics.

### Available Attributes

Attribute	Data Type	Allowed Values	Default	Description
INIT	Hexadecimal	Any 16-Bit Value	All zeros	Specifies initial contents of the RAM.

## For More Information

See the [Spartan-6 FPGA User Documentation \(User Guides and Data Sheets\)](#).

## RAM16X2S

### Primitive: 16-Deep by 2-Wide Static Synchronous RAM

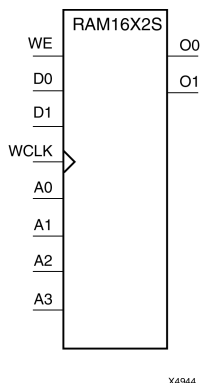

### Introduction

This element is a 16-word by 2-bit static random access memory with synchronous write capability. When the write enable (WE) is Low, transitions on the write clock (WCLK) are ignored and data stored in the RAM is not affected. When WE is High, any positive transition on WCLK loads the data on the data input (D1:D0) into the word selected by the 4-bit address (A3:A0). For predictable performance, address and data inputs must be stable before a Low-to-High WCLK transition. This RAM block assumes an active-High WCLK. However, WCLK can be active-High or active-Low. Any inverter placed on the WCLK input net is absorbed into the block.

The signal output on the data output pins (O1:O0) is the data that is stored in the RAM at the location defined by the values on the address pins.

You can use the INIT\_xx properties to specify the initial contents of a wide RAM. INIT\_00 initializes the RAM cells corresponding to the O0 output, INIT\_01 initializes the cells corresponding to the O1 output, etc. For example, a RAM16X2S instance is initialized by INIT\_00 and INIT\_01 containing 4 hex characters each. A RAM16X8S instance is initialized by eight properties INIT\_00 through INIT\_07 containing 4 hex characters each. A RAM64x2S instance is completely initialized by two properties INIT\_00 and INIT\_01 containing 16 hex characters each.

Except for Virtex-4 devices, the initial contents of this element cannot be specified directly.

### Logic Table

Inputs			Outputs
WE (mode)	WCLK	D1:D0	O1:O0
0 (read)	X	X	Data
1 (read)	0	X	Data
1 (read)	1	X	Data
1 (write)	↑	D1:D0	D1:D0
1 (read)	↓	X	Data

Data = word addressed by bits A3:A0

### Design Entry Method

This design element can be used in schematics.

## Available Attributes

Attribute	Data Type	Allowed Values	Default	Description
INIT_00 to INIT_01	Hexadecimal	Any 16-Bit Value	All zeros	Initializes RAMs, registers, and look-up tables.

## For More Information

See the [Spartan-6 FPGA User Documentation \(User Guides and Data Sheets\)](#).

## RAM16X4S

### Primitive: 16-Deep by 4-Wide Static Synchronous RAM

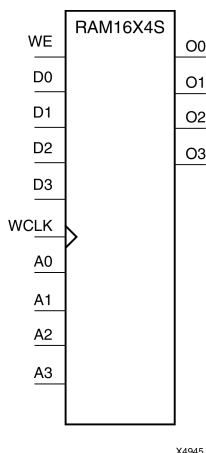

### Introduction

This element is a 16-word by 4-bit static random access memory with synchronous write capability. When the write enable (WE) is Low, transitions on the write clock (WCLK) are ignored and data stored in the RAM is not affected. When WE is High, any positive transition on WCLK loads the data on the data input (D3:D0) into the word selected by the 4-bit address (A3:A0). For predictable performance, address and data inputs must be stable before a Low-to-High WCLK transition. This RAM block assumes an active-High WCLK. However, WCLK can be active-High or active-Low. Any inverter placed on the WCLK input net is absorbed into the block.

The signal output on the data output pins (O3:O0) is the data that is stored in the RAM at the location defined by the values on the address pins.

### Logic Table

Inputs			Outputs
WE (mode)	WCLK	D3:D0	O3:O0
0 (read)	X	X	Data
1 (read)	0	X	Data
1 (read)	1	X	Data
1 (write)	↑	D3:D0	D3:D0
1 (read)	↓	X	Data

Data = word addressed by bits A3:A0.

### Design Entry Method

This design element is only for use in schematics.

### Available Attributes

Attribute	Data Type	Allowed Values	Default	Description
INIT_00 to INIT_03	Hexadecimal	Any 16-Bit Value	All zeros	INIT of RAM

## For More Information

See the [Spartan-6 FPGA User Documentation \(User Guides and Data Sheets\)](#).

## RAM16X8S

Primitive: 16-Deep by 8-Wide Static Synchronous RAM

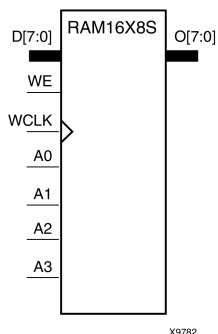

### Introduction

This element is a 16-word by 8-bit static random access memory with synchronous write capability. When the write enable (WE) is Low, transitions on the write clock (WCLK) are ignored and data stored in the RAM is not affected. When WE is High, any positive transition on WCLK loads the data on data inputs (D7:D0) into the word selected by the 4-bit address (A3:A0). For predictable performance, address and data inputs must be stable before a Low-to-High WCLK transition. This RAM block assumes an active-High WCLK. However, WCLK can be active-High or active-Low. Any inverter placed on the WCLK input net is absorbed into the block.

The signal output on the data output pins (O7:O0) is the data that is stored in the RAM at the location defined by the values on the address pins.

### Logic Table

Inputs			Outputs
WE (mode)	WCLK	D7:D0	O7:O0
0 (read)	X	X	Data
1 (read)	0	X	Data
1 (read)	1	X	Data
1 (write)	↑	D7:D0	D7:D0
1 (read)	↓	X	Data

Data = word addressed by bits A3:A0

### Design Entry Method

This design element is only for use in schematics.

### Available Attributes

Attribute	Data Type	Allowed Values	Default	Description
INIT_00 to INIT_07	Hexadecimal	Any 16-Bit Value	All zeros	Initializes RAMs, registers, and look-up tables.

### For More Information

See the [Spartan-6 FPGA User Documentation \(User Guides and Data Sheets\)](#).



# RAM256X1S

Primitive: 256-Deep by 1-Wide Random Access Memory (Select RAM)

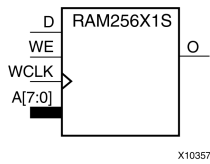

## Introduction

This design element is a 256-bit deep by 1-bit wide random access memory with synchronous write and asynchronous read capability. This RAM is implemented using the LUT resources of the device (also known as Select RAM), and does not consume any of the block RAM resources of the device. If a synchronous read capability is preferred, a register can be attached to the output and placed in the same slice as long as the same clock is used for both the RAM and the register. The RAM256X1S has an active, High write enable, WE, so that when that signal is High, and a rising edge occurs on the WCLK pin, a write is performed recording the value of the D input data pin into the memory array. The output O displays the contents of the memory location addressed by A, regardless of the WE value. When a write is performed, the output is updated to the new value shortly after the write completes.

## Port Descriptions

Port	Direction	Width	Function
O	Output	1	Read/Write port data output addressed by A
D	Input	1	Write data input addressed by A
A	Input	8	Read/Write port address bus
WE	Input	1	Write Enable
WCLK	Input	1	Write clock (reads are asynchronous)

## Design Entry Method

This design element can be used in schematics.

If instantiated, the following connections should be made to this component:

- Tie the WCLK input to the desired clock source, the D input to the data source to be stored, and the O output to an FDCE D input or other appropriate data destination.
- The WE clock enable pin should be connected to the proper write enable source in the design.
- The 8-bit A bus should be connected to the source for the read/write.
- An optional INIT attribute consisting of a 256-bit Hexadecimal value can be specified to indicate the initial contents of the RAM.

If left unspecified, the initial contents default to all zeros.

## Available Attributes

Attribute	Data Type	Allowed Values	Default	Description
INIT	Hexadecimal	Any 256-Bit Value	All zeros	Specifies the initial contents of the RAM.

## For More Information

- See the [Spartan-6 FPGA Configurable Logic Block User Guide \(UG384\)](#).
- See the [Spartan-6 FPGA Data Sheet: DC and Switching Characteristics \(DS162\)](#).

# RAM32M

## Primitive: 32-Deep by 8-bit Wide Multi Port Random Access Memory (Select RAM)

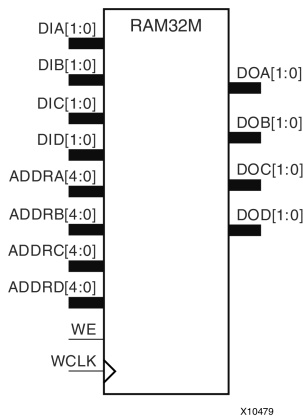

### Introduction

This design element is a 32-bit deep by 8-bit wide, multi-port, random access memory with synchronous write and asynchronous independent, 2-bit, wide-read capability. This RAM is implemented using the LUT resources of the device known as SelectRAM™, and does not consume any of the Block RAM resources of the device. The RAM32M is implemented in a single slice and consists of one 8-bit write, 2-bit read port and three separate 2-bit read ports from the same memory. This configuration allows for byte-wide write and independent 2-bit read access RAM. If the DIA, DIB, DIC and DID inputs are all tied to the same data inputs, the RAM can become a 1 read/write port, 3 independent read port, 32x2 quad port memory. If DID is grounded, DOD is not used, while ADDRA, ADDR B and ADDRC are tied to the same address, the RAM becomes a 32x6 simple dual port RAM. If ADDR D is tied to ADDRA, ADDR B, and ADDRC, then the RAM is a 32x8 single port RAM. There are several other possible configurations for this RAM.

### Port Descriptions

Port	Direction	Width	Function
DOA	Output	2	Read port data outputs addressed by ADDRA
DOB	Output	2	Read port data outputs addressed by ADDR B
DOC	Output	2	Read port data outputs addressed by ADDRC
DOD	Output	2	Read/Write port data outputs addressed by ADDR D
DIA	Input	2	Write data inputs addressed by ADDR D (read output is addressed by ADDRA)
DIB	Input	2	Write data inputs addressed by ADDR D (read output is addressed by ADDR B)
DIC	Input	2	Write data inputs addressed by ADDR D (read output is addressed by ADDRC)
DID	Input	2	Write data inputs addressed by ADDR D
ADDRA	Input	5	Read address bus A
ADDR B	Input	5	Read address bus B
ADDRC	Input	5	Read address bus C
ADDR D	Input	5	8-bit data write port, 2-bit data read port address bus D

Port	Direction	Width	Function
WE	Input	1	Write Enable
WCLK	Input	1	Write clock (reads are asynchronous)

## Design Entry Method

This design element can be used in schematics.

## Available Attributes

Attribute	Data Type	Allowed Values	Default	Description
INIT_A	Hexadecimal	Any 64-Bit Value	All zeros	Specifies the initial contents of the RAM on the A port.
INIT_B	Hexadecimal	Any 64-Bit Value	All zeros	Specifies the initial contents of the RAM on the B port.
INIT_C	Hexadecimal	Any 64-Bit Value	All zeros	Specifies the initial contents of the RAM on the C port.
INIT_D	Hexadecimal	Any 64-Bit Value	All zeros	Specifies the initial contents of the RAM on the D port.

## For More Information

- See the [Spartan-6 FPGA Configurable Logic Block User Guide \(UG384\)](#).
- See the [Spartan-6 FPGA Data Sheet: DC and Switching Characteristics \(DS162\)](#).

# RAM32X1D

## Primitive: 32-Deep by 1-Wide Static Dual Port Synchronous RAM

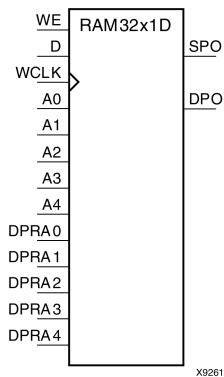

### Introduction

The design element is a 32-word by 1-bit static dual port random access memory with synchronous write capability. The device has two separate address ports: the read address (DPRA4:DPRA0) and the write address (A4:A0). These two address ports are completely asynchronous. The read address controls the location of the data driven out of the output pin (DPO), and the write address controls the destination of a valid write transaction. When the write enable (WE) is Low, transitions on the write clock (WCLK) are ignored and data stored in the RAM is not affected. When WE is High, any positive transition on WCLK loads the data on the data input (D) into the word selected by the 5-bit write address. For predictable performance, write address and data inputs must be stable before a Low-to-High WCLK transition. This RAM block assumes an active-High WCLK. WCLK can be active-High or active-Low. Any inverter placed on the WCLK input net is absorbed into the block. You can initialize RAM32X1D during configuration using the INIT attribute. Mode selection is shown in the following logic table.

The SPO output reflects the data in the memory cell addressed by A4:A0. The DPO output reflects the data in the memory cell addressed by DPRA4:DPRA0. The write process is not affected by the address on the read address port.

### Logic Table

Inputs			Outputs	
WE (Mode)	WCLK	D	SPO	DPO
0 (read)	X	X	data_a	data_d
1 (read)	0	X	data_a	data_d
1 (read)	1	X	data_a	data_d
1 (write)	↑	D	D	data_d
1 (read)	↓	X	data_a	data_d

### Design Entry Method

This design element can be used in schematics.

## Available Attributes

Attribute	Data Type	Allowed Values	Default	Descriptions
INIT	Hexadecimal	Any 32-Bit Value	All Zeros	Initializes ROMs, RAMs, registers, and look-up tables.

## For More Information

See the [Spartan-6 FPGA User Documentation \(User Guides and Data Sheets\)](#).

## RAM32X1S

Primitive: 32-Deep by 1-Wide Static Synchronous RAM

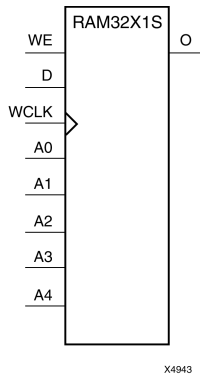

### Introduction

The design element is a 32-word by 1-bit static random access memory with synchronous write capability. When the write enable is Low, transitions on the write clock (WCLK) are ignored and data stored in the RAM is not affected. When (WE) is High, any positive transition on (WCLK) loads the data on the data input (D) into the word selected by the 5-bit address (A4-A0). For predictable performance, address and data inputs must be stable before a Low-to-High (WCLK) transition. This RAM block assumes an active-High (WCLK). However, (WCLK) can be active-High or active-Low. Any inverter placed on the (WCLK) input net is absorbed into the block.

The signal output on the data output pin (O) is the data that is stored in the RAM at the location defined by the values on the address pins. You can initialize RAM32X1S during configuration using the INIT attribute.

### Logic Table

Inputs			Outputs
WE (Mode)	WCLK	D	O
0 (read)	X	X	Data
1 (read)	0	X	Data
1 (read)	1	X	Data
1 (write)	↑	D	D
1 (read)	↓	X	Data

### Design Entry Method

This design element can be used in schematics.

### Available Attributes

Attribute	Data Type	Allowed Values	Default	Descriptions
INIT	Hexadecimal	Any 32-Bit Value	All zeros	Specifies initial contents of the RAM.

### For More Information

- See the [Spartan-6 FPGA Configurable Logic Block User Guide \(UG384\)](#).
- See the [Spartan-6 FPGA Data Sheet: DC and Switching Characteristics \(DS162\)](#).

## RAM32X1S\_1

Primitive: 32-Deep by 1-Wide Static Synchronous RAM with Negative-Edge Clock

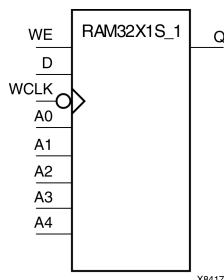

### Introduction

The design element is a 32-word by 1-bit static random access memory with synchronous write capability. When the write enable is Low, transitions on the write clock (WCLK) are ignored and data stored in the RAM is not affected. When (WE) is High, any negative transition on (WCLK) loads the data on the data input (D) into the word selected by the 5-bit address (A4:A0). For predictable performance, address and data inputs must be stable before a High-to-Low (WCLK) transition. This RAM block assumes an active-Low (WCLK). However, (WCLK) can be active-High or active-Low. Any inverter placed on the (WCLK) input net is absorbed into the block.

The signal output on the data output pin (O) is the data that is stored in the RAM at the location defined by the values on the address pins. You can initialize RAM32X1S\_1 during configuration using the INIT attribute.

### Logic Table

Inputs			Outputs
WE (Mode)	WCLK	D	O
0 (read)	X	X	Data
1 (read)	0	X	Data
1 (read)	1	X	Data
1 (write)	↓	D	D
1 (read)	↑	X	Data

Data = word addressed by bits A4:A0

### Design Entry Method

This design element can be used in schematics.

### Available Attributes

Attribute	Data Type	Allowed Values	Default	Descriptions
INIT	Hexadecimal	Any 32-Bit Value	0	Initializes RAMs, registers, and look-up tables.

### For More Information

See the [Spartan-6 FPGA User Documentation \(User Guides and Data Sheets\)](#).



# RAM32X2S

Primitive: 32-Deep by 2-Wide Static Synchronous RAM

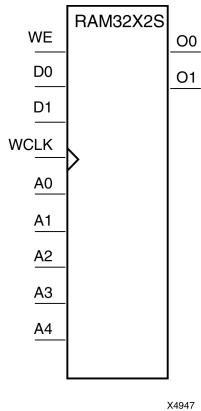

## Introduction

The design element is a 32-word by 2-bit static random access memory with synchronous write capability. When the write enable (WE) is Low, transitions on the write clock (WCLK) are ignored and data stored in the RAM is not affected. When (WE) is High, any positive transition on (WCLK) loads the data on the data input (D1-D0) into the word selected by the 5-bit address (A4-A0). For predictable performance, address and data inputs must be stable before a Low-to-High (WCLK) transition. This RAM block assumes an active-High (WCLK). However, (WCLK) can be active-High or active-Low. Any inverter placed on the (WCLK) input net is absorbed into the block. The signal output on the data output pins (O1-O0) is the data that is stored in the RAM at the location defined by the values on the address pins.

You can use the INIT\_00 and INIT\_01 properties to specify the initial contents of RAM32X2S.

## Logic Table

Inputs			Outputs
WE (Mode)	WCLK	D	O0-O1
0 (read)	X	X	Data
1 (read)	0	X	Data
1 (read)	1	X	Data
1 (write)	↑	D1:D0	D1:D0
1 (read)	↓	X	Data

Data = word addressed by bits A4:A0

## Design Entry Method

This design element can be used in schematics.

## Available Attributes

Attribute	Data Type	Allowed Values	Default	Descriptions
INIT_00	Hexadecimal	Any 32-Bit Value	All zeros	INIT for bit 0 of RAM.
INIT_01	Hexadecimal	Any 32-Bit Value	All zeros	INIT for bit 1 of RAM.

## For More Information

See the [Spartan-6 FPGA User Documentation \(User Guides and Data Sheets\)](#).

# RAM32X4S

Primitive: 32-Deep by 4-Wide Static Synchronous RAM

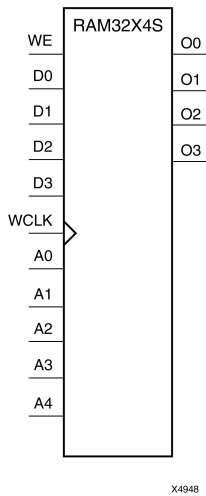

## Introduction

This design element is a 32-word by 4-bit static random access memory with synchronous write capability. When the write enable (WE) is Low, transitions on the write clock (WCLK) are ignored and data stored in the RAM is not affected. When WE is High, any positive transition on WCLK loads the data on the data inputs (D3-D0) into the word selected by the 5-bit address (A4:A0). For predictable performance, address and data inputs must be stable before a Low-to-High WCLK transition. This RAM block assumes an active-High WCLK. However, WCLK can be active-High or active-Low. Any inverter placed on the WCLK input net is absorbed into the block.

The signal output on the data output pins (O3-O0) is the data that is stored in the RAM at the location defined by the values on the address pins.

## Logic Table

Inputs			Outputs
WE	WCLK	D3-D0	O3-O0
0 (read)	X	X	Data
1 (read)	0	X	Data
1 (read)	1	X	Data
1 (write)	↑	D3:D0	D3:D0
1 (read)	↓	X	Data
Data = word addressed by bits A4:A0			

## Design Entry Method

This design element is only for use in schematics.

## Available Attributes

Attribute	Data Type	Allowed Values	Default	Description
INIT_00	Hexadecimal	Any 32-Bit Value	All zeros	INIT for bit 0 of RAM.
INIT_01	Hexadecimal	Any 32-Bit Value	All zeros	INIT for bit 1 of RAM.
INIT_02	Hexadecimal	Any 32-Bit Value	All zeros	INIT for bit 2 of RAM.
INIT_03	Hexadecimal	Any 32-Bit Value	All zeros	INIT for bit 3 of RAM.

## For More Information

See the [Spartan-6 FPGA User Documentation \(User Guides and Data Sheets\)](#).

# RAM32X8S

Primitive: 32-Deep by 8-Wide Static Synchronous RAM

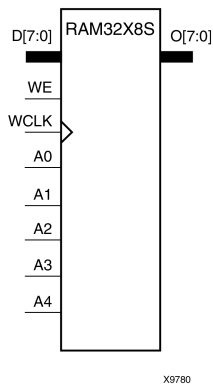

## Introduction

This design element is a 32-word by 8-bit static random access memory with synchronous write capability. When the write enable (WE) is Low, transitions on the write clock (WCLK) are ignored and data stored in the RAM is not affected. When WE is High, any positive transition on WCLK loads the data on the data inputs (D7:D0) into the word selected by the 5-bit address (A4:A0). For predictable performance, address and data inputs must be stable before a Low-to-High WCLK transition. This RAM block assumes an active-High WCLK. However, WCLK can be active-High or active-Low. Any inverter placed on the WCLK input net is absorbed into the block.

The signal output on the data output pins (O7:O0) is the data that is stored in the RAM at the location defined by the values on the address pins.

## Logic Table

Inputs			Outputs
WE (mode)	WCLK	D7:D0	O7:O0
0 (read)	X	X	Data
1 (read)	0	X	Data
1 (read)	1	X	Data
1 (write)	↑	D7:D0	D7:D0
1 (read)	↓	X	Data
Data = word addressed by bits A4:A0			

## Design Entry Method

This design element is only for use in schematics.

## Available Attributes

Attribute	Data Type	Allowed Values	Default	Description
INIT_00	Hexadecimal	Any 32-Bit Value	All zeros	INIT for bit 0 of RAM.
INIT_01	Hexadecimal	Any 32-Bit Value	All zeros	INIT for bit 1 of RAM.
INIT_02	Hexadecimal	Any 32-Bit Value	All zeros	INIT for bit 2 of RAM.
INIT_03	Hexadecimal	Any 32-Bit Value	All zeros	INIT for bit 3 of RAM.
INIT_04	Hexadecimal	Any 32-Bit Value	All zeros	INIT for bit 4 of RAM.
INIT_05	Hexadecimal	Any 32-Bit Value	All zeros	INIT for bit 5 of RAM.
INIT_06	Hexadecimal	Any 32-Bit Value	All zeros	INIT for bit 6 of RAM.
INIT_07	Hexadecimal	Any 32-Bit Value	All zeros	INIT for bit 7 of RAM.

## For More Information

See the [Spartan-6 FPGA User Documentation \(User Guides and Data Sheets\)](#).

# RAM64M

Primitive: 64-Deep by 4-bit Wide Multi Port Random Access Memory (Select RAM)

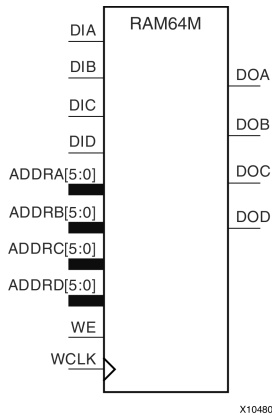

## Introduction

This design element is a 64-bit deep by 4-bit wide, multi-port, random access memory with synchronous write and asynchronous independent bit wide read capability. This RAM is implemented using the LUT resources of the device (also known as SelectRAM™) and does not consume any of the block RAM resources of the device. The RAM64M component is implemented in a single slice, and consists of one 4-bit write, 1-bit read port, and three separate 1-bit read ports from the same memory allowing for 4-bit write and independent bit read access RAM. If the DIA, DIB, DIC and DID inputs are all tied to the same data inputs, the RAM can become a 1 read/write port, 3 independent read port 64x1 quad port memory. If DID is grounded, DOD is not used. While ADDR A, ADDR B and ADDR C are tied to the same address the RAM becomes a 64x3 simple dual port RAM. If ADDR D is tied to ADDR A, ADDR B, and ADDR C; then the RAM is a 64x4 single port RAM. There are several other possible configurations for this RAM.

## Port Descriptions

Port	Direction	Width	Function
DOA	Output	1	Read port data outputs addressed by ADDR A
DOB	Output	1	Read port data outputs addressed by ADDR B
DOC	Output	1	Read port data outputs addressed by ADDR C
DOD	Output	1	Read/Write port data outputs addressed by ADDR D
DIA	Input	1	Write data inputs addressed by ADDR D (read output is addressed by ADDR A)
DIB	Input	1	Write data inputs addressed by ADDR D (read output is addressed by ADDR B)
DIC	Input	1	Write data inputs addressed by ADDR D (read output is addressed by ADDR C)
DID	Input	1	Write data inputs addressed by ADDR D
ADDR A	Input	6	Read address bus A
ADDR B	Input	6	Read address bus B
ADDR C	Input	6	Read address bus C
ADDR D	Input	6	4-bit data write port, 1-bit data read port address bus D

Port	Direction	Width	Function
WE	Input	1	Write Enable
WCLK	Input	1	Write clock (reads are asynchronous)

## Design Entry Method

This design element can be used in schematics.

## Available Attributes

Attribute	Data Type	Allowed Values	Default	Description
INIT_A	Hexadecimal	Any 64-Bit Value	All zero	Specifies the initial contents of the RAM on the A port.
INIT_B	Hexadecimal	Any 64-Bit Value	All zero	Specifies the initial contents of the RAM on the B port.
INIT_C	Hexadecimal	Any 64-Bit Value	All zero	Specifies the initial contents of the RAM on the C port.
INIT_D	Hexadecimal	Any 64-Bit Value	All zero	Specifies the initial contents of the RAM on the D port.

## For More Information

- See the [Spartan-6 FPGA Configurable Logic Block User Guide \(UG384\)](#).
- See the [Spartan-6 FPGA Data Sheet: DC and Switching Characteristics \(DS162\)](#).



# RAM64X1D

## Primitive: 64-Deep by 1-Wide Dual Port Static Synchronous RAM

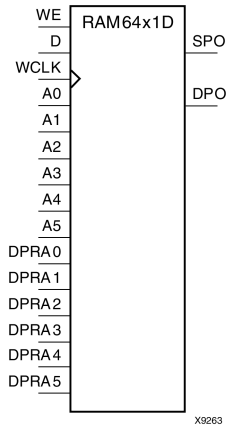

### Introduction

This design element is a 64-word by 1-bit static dual port random access memory with synchronous write capability. The device has two separate address ports: the read address (DPRA5:DPRA0) and the write address (A5:A0). These two address ports are completely asynchronous. The read address controls the location of the data driven out of the output pin (DPO), and the write address controls the destination of a valid write transaction. When the write enable (WE) is Low, transitions on the write clock (WCLK) are ignored and data stored in the RAM is not affected.

When WE is High, any positive transition on WCLK loads the data on the data input (D) into the word selected by the 6-bit (A0:A5) write address. For predictable performance, write address and data inputs must be stable before a Low-to-High WCLK transition. This RAM block assumes an active-High WCLK. WCLK can be active-High or active-Low. Any inverter placed on the WCLK input net is absorbed into the block.

The SPO output reflects the data in the memory cell addressed by A5:A0. The DPO output reflects the data in the memory cell addressed by DPRA5:DPRA0.

**Note** The write process is not affected by the address on the read address port.

### Logic Table

Inputs			Outputs	
WE (mode)	WCLK	D	SPO	DPO
0 (read)	X	X	data_a	data_d
1 (read)	0	X	data_a	data_d
1 (read)	1	X	data_a	data_d
1 (write)	↑	D	D	data_d
1 (read)	↓	X	data_a	data_d

data\_a = word addressed by bits A5:A0  
 data\_d = word addressed by bits DPRA5:DPRA0

### Design Entry Method

This design element can be used in schematics.

## Available Attributes

Attribute	Data Type	Allowed Values	Default	Description
INIT	Hexadecimal	Any 64-Bit Value	All zeros	Initializes RAMs, registers, and look-up tables.

## For More Information

- See the [Spartan-6 FPGA Configurable Logic Block User Guide \(UG384\)](#).
- See the [Spartan-6 FPGA Data Sheet: DC and Switching Characteristics \(DS162\)](#).

# RAM64X1S

## Primitive: 64-Deep by 1-Wide Static Synchronous RAM

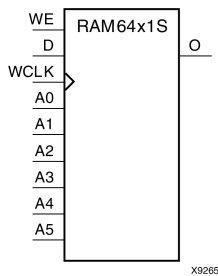

### Introduction

This design element is a 64-word by 1-bit static random access memory (RAM) with synchronous write capability. When the write enable is set Low, transitions on the write clock (WCLK) are ignored and data stored in the RAM is not affected. When WE is set High, any positive transition on WCLK loads the data on the data input (D) into the word selected by the 6-bit address (A5:A0). This RAM block assumes an active-High WCLK. However, WCLK can be active-High or active-Low. Any inverter placed on the WCLK input net is absorbed into the block.

The signal output on the data output pin (O) is the data that is stored in the RAM at the location defined by the values on the address pins.

You can initialize this element during configuration using the INIT attribute.

### Logic Table

Mode selection is shown in the following logic table

Inputs			Outputs
WE (mode)	WCLK	D	O
0 (read)	X	X	Data
1 (read)	0	X	Data
1 (read)	1	X	Data
1 (write)	↑	D	D
1 (read)	↓	X	Data

Data = word addressed by bits A5:A0

### Design Entry Method

This design element can be used in schematics.

### Available Attributes

Attribute	Data Type	Allowed Values	Default	Description
INIT	Hexadecimal	Any 64-Bit Value	All zeros	Initializes ROMs, RAMs, registers, and look-up tables.

## For More Information

- See the [Spartan-6 FPGA Configurable Logic Block User Guide \(UG384\)](#).
- See the [Spartan-6 FPGA Data Sheet: DC and Switching Characteristics \(DS162\)](#).

## RAM64X1S\_1

Primitive: 64-Deep by 1-Wide Static Synchronous RAM with Negative-Edge Clock

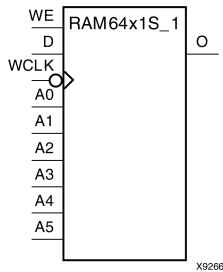

### Introduction

This design element is a 64-word by 1-bit static random access memory with synchronous write capability. When the write enable is Low, transitions on the write clock (WCLK) are ignored and data stored in the RAM is not affected. When (WE) is High, any negative transition on (WCLK) loads the data on the data input (D) into the word selected by the 6-bit address (A5:A0). For predictable performance, address and data inputs must be stable before a High-to-Low (WCLK) transition. This RAM block assumes an active-Low (WCLK). However, (WCLK) can be active-High or active-Low. Any inverter placed on the (WCLK) input net is absorbed into the block.

The signal output on the data output pin (O) is the data that is stored in the RAM at the location defined by the values on the address pins.

You can initialize this element during configuration using the INIT attribute.

### Logic Table

Inputs			Outputs
WE (mode)	WCLK	D	O
0 (read)	X	X	Data
1 (read)	0	X	Data
1 (read)	1	X	Data
1 (write)	↓	D	D
1 (read)	↑	X	Data

Data = word addressed by bits A5:A0

### Design Entry Method

This design element can be used in schematics.

### Available Attributes

Attribute	Data Type	Allowed Values	Default	Description
INIT	Hexadecimal	Any 64-Bit Value	All zeros	Initializes ROMs, RAMs, registers, and look-up tables.

### For More Information

See the [Spartan-6 FPGA User Documentation \(User Guides and Data Sheets\)](#).

## RAM64X2S

### Primitive: 64-Deep by 2-Wide Static Synchronous RAM

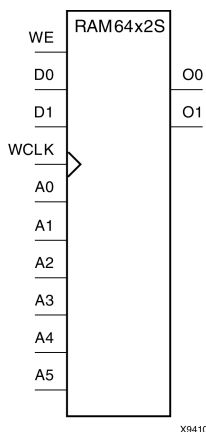

## Introduction

This design element is a 64-word by 2-bit static random access memory with synchronous write capability. When the write enable (WE) is Low, transitions on the write clock (WCLK) are ignored and data stored in the RAM is not affected. When WE is High, any positive transition on WCLK loads the data on the data input (D1:D0) into the word selected by the 6-bit address (A5:A0). For predictable performance, address and data inputs must be stable before a Low-to-High WCLK transition. This RAM block assumes an active-High WCLK. However, WCLK can be active-High or active-Low. Any inverter placed on the WCLK input net is absorbed into the block.

The signal output on the data output pins (O1:O0) is the data that is stored in the RAM at the location defined by the values on the address pins. You can use the INIT\_00 and INIT\_01 properties to specify the initial contents of this design element.

## Logic Table

Inputs			Outputs
WE (mode)	WCLK	D0:D1	O0:O1
0 (read)	X	X	Data
1 (read)	0	X	Data
1 (read)	1	X	Data
1 (write)	↑	D1:D0	D1:D0
1 (read)	↓	X	Data
Data = word addressed by bits A5:A0			

## Design Entry Method

This design element is only for use in schematics.

## Available Attributes

Attribute	Data Type	Allowed Values	Default	Description
INIT_00	Hexadecimal	Any 64-Bit Value	All zeros	Initializes RAMs, registers, and look-up tables.
INIT_01	Hexadecimal	Any 64-Bit Value	All zeros	Initializes RAMs, registers, and look-up tables.

## For More Information

See the [Spartan-6 FPGA User Documentation \(User Guides and Data Sheets\)](#).

## RAMB16BWER

Primitive: 16K-bit Data and 2K-bit Parity Configurable Synchronous Dual Port Block RAM with Optional Output Registers

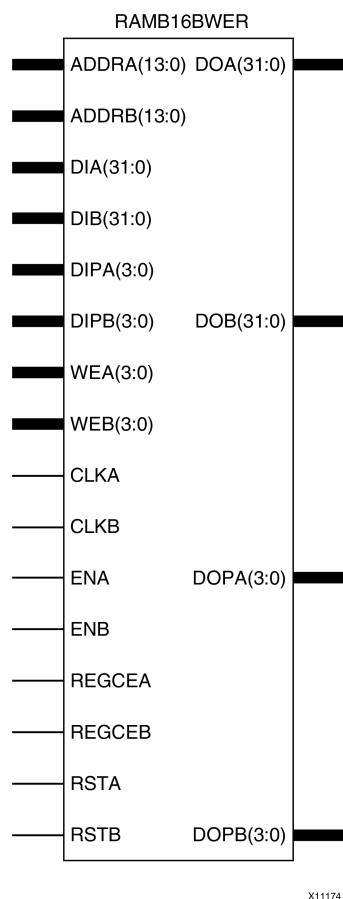

## Introduction

This design element contains several block RAM memories that can be configured as general-purpose 16kb data + 2kb parity RAM/ROM memories. These block RAM memories offer fast and flexible storage of large amounts of on-chip data. This component can be configured and used as a 1-bit wide by 16K deep to a 36-bit wide by 512 deep, single-port or dual port RAM. Both read and write operations are fully synchronous to the supplied clock(s) to the component. However, Port A and Port B can operate fully independently and asynchronously to each other, accessing the same memory array. When these ports are configured in the wider data width modes, byte-enable write operations are possible. This RAM also offers a configurable output register that can be enabled to improve clock-to-out times of the RAM while incurring an extra clock cycle of latency during the read operation.

## Port Descriptions

The following table shows the necessary input and output connections for the variable input ports for each DATA\_WIDTH value for either Port A or Port B.



DATA_WIDTH Value	DI, DIP Connections	ADDR Connections	WE Connections
1	DI[0]	ADDR[13:0]	Connect WE[3:0] to single user WE signal.
2	DI[1:0]	ADDR[13:1]	Connect WE[3:0] to single user WE signal.
4	DI[3:0]	ADDR[13:2]	Connect WE[3:0] to single user WE signal.
9	DI[7:0], DIP[0]	ADDR[13:3]	Connect WE[3:0] to single user WE signal.
18	DI[15:0], DIP[1:0]	ADDR[13:4]	Connect WE[0] and WE[2] to user WE[0] and WE[1] and WE[3] to user WE[1].
36	DI[31:0], DIP[3:0]	ADDR[13:5]	Connect each WE[3:0] signal to the associated byte write enable.

Alternatively, the older RAMB16\_Sm\_Sn and RAMB16BWER\_Sm\_Sn elements can be instantiated if the output registers are not necessary. If any of these components are used, the software will automatically retarget them to a properly configured RAMB16BWER element.

Port	Direction	Width	Function
ADDRA[13:0]	Input	14	Port A address input bus. MSB always exists on ADDRA[13] while the LSB is determined by the settings for DATA_WIDTH_A.
ADDRB[13:0]	Input	14	Port B address input bus. MSB always exists on ADDR[13] while the LSB is determined by the settings for DATA_WIDTH_B.
CLKA	Input	1	Port A clock input.
CLKB	Input	1	Port B clock input.
DIA[31:0]	Input	32	Port A data input bus.
DIB[31:0]	Input	32	Port B data input bus.
DIPA[3:0]	Input	4	Port A parity input bus.
DIPB[3:0]	Input	4	Port B parity input bus.
DOA[31:0]	Output	32	Port A data output bus.
DOB[31:0]	Output	32	Port B data output bus.
DOPA[3:0]	Output	4	Port A parity output bus.
DOPB[3:0]	Output	4	Port B parity output bus.
ENA	Input	1	Port A enable.
ENB	Input	1	Port B enable.
REGCEA	Input	1	Output register clock enable.
REGCEB	Input	1	Output register clock enable.
RSTA	Input	1	Port A output registers set/reset. This reset is configurable to be synchronous or asynchronous, depending on the value of the RSTTYPE attribute.
RSTB	Input	1	Port B output registers set/reset. This reset is configurable to be synchronous or asynchronous, depending on the value of the RSTTYPE attribute.
WEA[3:0]	Input	4	Port A byte-wide write enable.
WEB[3:0]	Input	4	Port B byte-wide write enable.

## Design Entry Method

This design element can be used in schematics.

Connect all necessary inputs to the desired signals in the design. The CLKA/CLKB clock signals must be tied to an active clock for RAM operation, and the SRA/SRB reset signals must be either tied to a logic zero or to the proper reset signal. ENA/ENB must either be tied to a logic one or a proper RAM port enable signal. REGCEA and REGCEB must be tied to the proper output register clock enable, or a logic one if the respective DOA\_REG or DOB\_REG attribute is set to 1. If DOA\_REG is set to 0, then REGCEA and REGCEB must be set to a logic 0.

Refer to the DATA\_WIDTH column in the "Port Description" table (above) for the necessary data input, data output, write enable and address connection information for each DATA\_WIDTH setting, since the necessary connections for these signals change, based on this attribute. All other output signals can be left unconnected (open) and all unused input signals should be tied to a logic zero.

## Available Attributes

Attribute	Data Type	Allowed Values	Default	Description
DATA_WIDTH_A	Integer	0, 1, 2, 4, 9, 18, 36	0	Specifies the configurable data width for port A. Need not equal the width for port B.
DATA_WIDTH_B	Integer	0, 1, 2, 4, 9, 18, 36	0	Specifies the configurable data width for port B. Need not equal the width for port A.
DOA_REG	Integer	0, 1	0	Set to 1 to use the A port output registers.
DOB_REG	Integer	0, 1	0	Set to 1 to use the B port output registers.
EN_RSTRAM_A	String	"TRUE", "FALSE"	"TRUE"	Disables A port RST capability when equal to FALSE and enables this capability when equal to TRUE.
EN_RSTRAM_B	String	"TRUE", "FALSE"	"TRUE"	Disables B port RST capability when equal to FALSE and enables this capability when equal to TRUE.
INIT_A	Hexa-decimal	36'h00000000 to 36'hfffffff	All zeros	Specifies the initial value on the port A output after configuration.
INIT_B	Hexa-decimal	36'h00000000 to 36'hfffffff	All zeros	Specifies the initial value on the Port B output after configuration.
INIT_FILE	String	String representing file name and location	NONE	File name of file used to specify initial RAM contents.
INIT_00 to INIT_3F	Hexa-decimal	Any 256 bit value	All zeros	Specifies the initial contents of the 16 kb data memory array.
INITP_01 to INITP_07	Hexa-decimal	Any 256 bit value	All zeros	Specifies the initial contents of the 2 kb parity data memory array.
RST_PRIORITY_A	String	"CE", "SR"	"CE"	When DOA_REG=0, selects the priority between the A port RAM EN and RST pin. When DOA_REG=1 (using the optional output register), selects priority between REGCE and RST pin.
RST_PRIORITY_B	String	"CE", "SR"	"CE"	When DOB_REG=0, selects the priority between the B port RAM EN and RST pin. When DOB_REG=1 (using the optional output register), selects priority between REGCE and RST pin.

Attribute	Data Type	Allowed Values	Default	Description
RSTTYPE	String	"SYNC", "ASYNC"	"SYNC"	Selects whether the RAM outputs should have a synchronous or asynchronous reset capability. Due to improved timing and circuit stability, it is recommended to always have this set to "SYNC" unless an asynchronous reset is absolutely necessary.
SIM_COLLISION_CHECK	String	"ALL", "GENERATE_X_ONLY", "WARNING_ONLY", "NONE"	"ALL"	<p>Allows modification of the simulation behavior so that if a memory collision occurs:</p> <ul style="list-style-type: none"> <li>"ALL" - Warning produced and affected outputs/memory go unknown (X).</li> <li>"WARNING_ONLY" - Warning produced and affected outputs/memory retain last value.</li> <li>"GENERATE_X_ONLY" - No warning, but affected outputs/memory go unknown (X).</li> <li>"NONE" - No warning and affected outputs/memory retain last value.</li> </ul> <p><b>Note</b> Setting this to a value other than "ALL" can allow problems in the design to go unnoticed during simulation. Care should be taken when changing the value of this attribute.</p>
SRVAL_A	Hexa-decimal	36'h00000000 to 36'hfffffff	All zeros	Specifies the output value of Port A upon the assertion of the reset (RSTA) signal.
SRVAL_B	Hexa-decimal	36'h00000000 to 36'hfffffff	All zeros	Specifies the output value of Port B upon the assertion of the reset (RSTB) signal.
WRITE_MODE_A	String	"WRITE_FIRST", "READ_FIRST", "NO_CHANGE"	"WRITE_FIRST"	<p>Specifies output behavior of the port being written to:</p> <ul style="list-style-type: none"> <li>"WRITE_FIRST" - Written value appears on output port of the RAM.</li> <li>"READ_FIRST" - Previous RAM contents for that memory location appear on the output port.</li> <li>"NO_CHANGE" - Previous value on the output port remains the same.</li> </ul>
WRITE_MODE_B	String	"WRITE_FIRST", "READ_FIRST", "NO_CHANGE"	"WRITE_FIRST"	<p>Specifies output behavior of the port being written to:</p> <ul style="list-style-type: none"> <li>"WRITE_FIRST" - Written value appears on output port of the RAM.</li> <li>"READ_FIRST" - Previous RAM contents for that memory location appear on the output port.</li> <li>"NO_CHANGE" - Previous value on the output port remains the same.</li> </ul>

## For More Information

- See the [Spartan-6 FPGA Block RAM User Guide \(UG383\)](#).
- See the [Spartan-6 FPGA Data Sheet: DC and Switching Characteristics \(DS162\)](#).

## RAMB8BWER

Primitive: 8K-bit Data and 1K-bit Parity Configurable Synchronous Dual Port Block RAM with Optional Output Registers

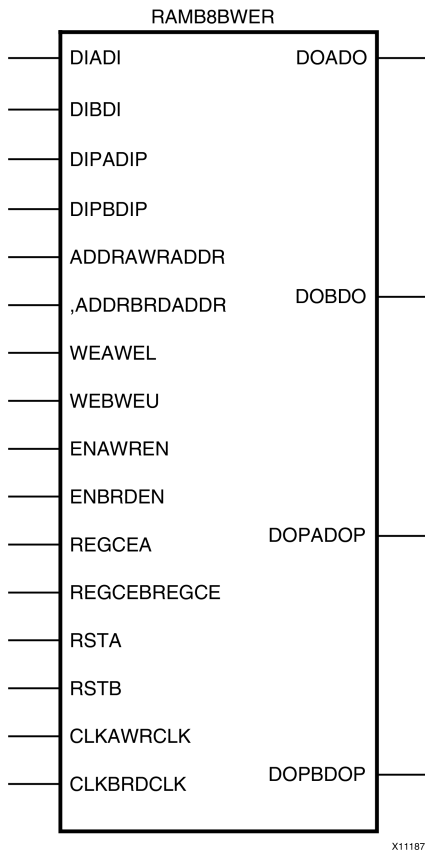

### Introduction

Spartan®-6 devices contain several block RAM memories that can be configured as general-purpose RAM/ROM memories. These block RAM memories offer fast and flexible storage of large amounts of on-chip data. The RAMB8BWER allows access to the block RAM in the 8KB data + 1KB parity configuration. This element can be configured and used as a 1-bit wide by 8K deep to an 18-bit wide by 512-bit deep true dual port RAM. This element can also be configured as a 36-bit wide by 246 deep simple dual port RAM. Both read and write operations are fully synchronous to the supplied clock(s) to the component. However, the READ and WRITE ports can operate fully independent and asynchronous to each other, accessing the same memory array. When configured in the wider data width modes, byte-enable write operations are possible. This RAM also offers a configurable output register that can be enabled in order to improve clock-to-out times of the RAM while incurring an extra clock cycle of latency during the read operation.

## Port Descriptions

Port	Direction	Width	Function
ADDRWRADDR[12:0]	Input	13	Port A address input bus when RAM_MODE=TDP. MSB always exists on ADDRWRADDR[12] while the LSB is determined by the settings for DATA_WIDTH_A. Write address input bus when RAM_MODE=SDP.
ADDRBRDADDR[12:0]	Input	13	Port B address input bus when RAM_MODE=TDP. MSB always exists on ADDRBRDADDR[12] while the LSB is determined by the settings for DATA_WIDTH_B. Write address input bus when RAM_MODE=SDP.
CLKAWRCLK	Input	1	Port A clock input/Write clock input.
CLKBRDCLK	Input	1	Port B clock input/Read clock input.
DIADI[15:0]	Input	16	Port A data input bus when RAM_MODE=TDP. Data input bus addressed by WRADDR when RAM_MODE=SDP. DIADI is the logical DI[15:0] for SDP mode.
DIBDI[15:0]	Input	16	Port B data input bus when RAM_MODE=TDP. Data input bus addressed by WRADDR when RAM_MODE=SDP. DIBDI is the logical DI[31:16] for SDP mode.
DIPADIP[1:0]	Input	2	Port A parity data input bus when RAM_MODE=TDP. Data parity input bus addressed by WRADDR when RAM_MODE=SDP. DIPADIP is the logical DIP[1:0] for SDP mode.
DIPBDIP[1:0]	Input	2	Port B parity data input bus when RAM_MODE=TDP. Data parity input bus addressed by WRADDR when RAM_MODE=SDP. DIPBDIP is the logical DIP[3:2] for SDP mode.
DOADO[15:0]	Output	16	Port A data output bus/Data output bus addressed by RDADDR. When RAM_MODE=SDP, DOADO is the logical DO[15:0].
DOBDO[15:0]	Output	16	Port B data output bus/Data output bus addressed by RDADDR. When RAM_MODE=SDP, DOBDO is the logical DO[31:16].
DOPADOP[1:0]	Output	2	Port A parity data output bus/Data parity output bus addressed by RDADDR. When RAM_MODE=SDP, DOPADOP is the logical DOP[1:0].
DOPBDOP[1:0]	Output	2	Port B parity data output bus/Data parity output bus addressed by RDADDR. When RAM_MODE=SDP, DOPBDOP is the logical DOP[3:2].
ENAWREN	Input	1	Port A RAM enable/Write enable.
ENBRDEN	Input	1	Port B RAM enable/Read enable.
REGCEA	Input	1	Port A output register clock enable input (valid only when DOA_REG=1). Not used when RAM_MODE=SDP.
REGCEBREGCE	Input	1	Port B output register clock enable input (valid only when DOB_REG=1). Output register clock enable input when RAM_MODE=SDP.
RSTA	Input	1	Port A set/reset value indicated by SRVAL_A. This reset is configurable to be synchronous or asynchronous depending on the value of the RSTTYPE attribute. Affects the output value on the output registers (DOA_REG=1) as well as on the output latches. Not used when RAM_MODE=SDP.

Port	Direction	Width	Function
RSTBRST	Input	1	Port B set/reset to value indicated by SRVAL_B. This reset is configurable to be synchronous or asynchronous depending on the value of the RSTTYPE attribute. Affects the output value on the output registers (DOB_REG=1) as well as on the output latches. This is the Reset input when RAM_MODE=SDP.
WEAWEL	Input	2	Port A byte-wide write enable when RAM_MODE=TDP. In SDP mode, WEAWEL is logical WE[1:0].
WEBWEU	Input	2	Port B byte-wide write enable when RAM_MODE=TDP. In SDP mode, WEBWEU is logical WE[3:2].

## Design Entry Method

This design element can be used in schematics.

## Available Attributes

Attribute	Data Type	Allowed Values	Default	Description
DATA_WIDTH_A	Integer	0, 1, 2, 4, 9, 18, 36	0	Specifies the configurable data width for port A. Need not equal the width for port B. A width of 36 is valid for SDP mode only.
DATA_WIDTH_B	Integer	0, 1, 2, 4, 9, 18, 36	0	Specifies the configurable data width for port B. Need not equal the width for port A. A width of 36 is valid for SDP mode only.
DOA_REG	Integer	0, 1	0	Set to 1 to use the A port output registers. Applies to port A in TDP mode and up to 18 low order bits (including parity bits) in SDP mode.
DOB_REG	Integer	0, 1	0	Set to 1 to use the B port output registers. Applies to port B in TDP mode and up to 18 high order bits (including parity bits) in SDP mode.
EN_RSTRAM_A	String	"TRUE", "FALSE"	"TRUE"	Disables A port RST capability when equal to FALSE and enables this capability when equal to TRUE.
EN_RSTRAM_B	String	"TRUE", "FALSE"	"TRUE"	Disables B port RST capability when equal to FALSE and enables this capability when equal to TRUE.
INIT_A	Hexa-decimal	18'h00000 to 18'h3ffff	All zeros	Specifies the initial value on the port A output after configuration. Applies to port A in TDP mode and up to 18 low order bits (including parity bits) in SDP mode.
INIT_B	Hexa-decimal	18'h00000 to 18'h3ffff	All zeros	Specifies the initial value on the port B output after configuration. Applies to port B in TDP mode and up to 18 high order bits (including parity bits) in SDP mode.
INIT_FILE	String	String representing file name and location	None	File name of file used to specify initial RAM contents.
INIT_00 to INIT_1F	Hexa-decimal	Any 256 bit value	All zeros	Allows specification of the initial contents of the 8KB data memory array.

Attribute	Data Type	Allowed Values	Default	Description
INITP_01 to INITP_03	Hexa-decimal	Any 256 bit value	All zeros	Allows specification of the initial contents of the 1KB parity data memory array.
RAM_MODE	String	"TDP", "SDP"	"TDP"	Select "SDP" to configure this element as a simple dual port RAM (write-only on one port and read-only on the other). Select "TDP" to configure this element as a true dual port RAM (read and write capability on one or both ports).
RST_PRIORITY_A	String	"CE", "SR"	"CE"	When DOA_REG=0, selects the priority between the A port RAM EN and RST pin. When DOA_REG=1 (using the optional output register), selects priority between REGCE and RST pin.
RST_PRIORITY_B	String	"CE", "SR"	"CE"	When DOB_REG=0, selects the priority between the B port RAM EN and RST pin. When DOB_REG=1 (using the optional output register), selects priority between REGCE and RST pin.
RSTTYPE	String	"SYNC", "ASYNC"	"SYNC"	Selects whether the RAM outputs should have a synchronous or asynchronous reset capability. Due to improved timing and circuit stability, it is recommended to always have this set to "SYNC" unless an asynchronous reset is absolutely necessary.
SIM_COLLISION_CHECK	String	"ALL", "GENERATE_X_ONLY", "WARNING_ONLY", "NONE"	ALL	Allows modification of the simulation behavior so that if a memory collision occurs: <ul style="list-style-type: none"> <li>• ALL - Warning produced and affected outputs/memory location go unknown (X).</li> <li>• WARNING_ONLY - Warning produced and affected outputs/memory retain last value.</li> <li>• GENERATE_X_ONLY - No warning, but affected outputs/memory go unknown (X).</li> <li>• NONE - No warning and affected outputs/memory retain last value.</li> </ul> <b>Note</b> Setting this to a value other than "ALL" can allow problems in the design to go unnoticed during simulation. Care should be taken when changing the value of this attribute.
SRVAL_A	Hexa-decimal	18'h00000 to 18'h3ffff	All zeros	Specifies the output value of Port A upon the assertion of the reset (RSTA) signal. Applies to port A in TDP mode. In SDP mode, use only SRVAL_A if the port width is 18 bits or less. If the port width is greater than 18 bits, SRVAL_A applies to the 18 low order bits (including parity bits).



Attribute	Data Type	Allowed Values	Default	Description
SRVAL_B	Hexa-decimal	18'h00000 to 18'h3ffff	All zeros	Specifies the output value of Port B upon the assertion of the reset (RSTB) signal. Applies to port B in TDP mode. In SDP mode, use only SRVAL_A if the port width is 18 bits or less. If the port width is greater than 18 bits, SRVAL_B applies to the 18 high order bits (including parity bits).
WRITE_MODE_A	String	"WRITE_FIRST", "READ_FIRST", "NO_CHANGE"	"WRITE_FIRST"	Specifies output behavior of the port being written to: <ul style="list-style-type: none"> <li>• WRITE_FIRST - Written value appears on output port of the RAM.</li> <li>• READ_FIRST - Previous RAM contents for that memory location appear on the output port.</li> <li>• NO_CHANGE - Previous value on the output port remains the same.</li> </ul> When RAM_MODE=SDP, WRITE_MODE_A must equal "READ_FIRST" (when using a common clock on both ports) or "WRITE_FIRST" (when using different clocks on both ports).
WRITE_MODE_B	String	"WRITE_FIRST", "READ_FIRST", "NO_CHANGE"	"WRITE_FIRST"	Specifies output behavior of the port being written to: <ul style="list-style-type: none"> <li>• WRITE_FIRST - Written value appears on output port of the RAM.</li> <li>• READ_FIRST - Previous RAM contents for that memory location appear on the output port.</li> <li>• NO_CHANGE - Previous value on the output port remains the same.</li> </ul> When RAM_MODE=SDP, WRITE_MODE_B must equal "READ_FIRST" (when using a common clock on both ports) or "WRITE_FIRST" (when using different clocks on both ports).

## For More Information

- See the [Spartan-6 FPGA Block RAM User Guide](#)
- See the [Spartan-6 FPGA Data Sheet: DC and Switching Characteristics](#).

## ROM128X1

Primitive: 128-Deep by 1-Wide ROM

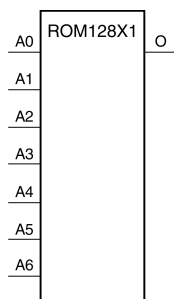

X9731

### Introduction

This design element is a 128-word by 1-bit read-only memory. The data output (O) reflects the word selected by the 7-bit address (A6:A0). The ROM is initialized to a known value during configuration with the INIT=value parameter. The value consists of 32 hexadecimal digits that are written into the ROM from the most-significant digit A=FH to the least-significant digit A=0H. An error occurs if the INIT=value is not specified.

### Logic Table

Input				Output
I0	I1	I2	I3	O
0	0	0	0	INIT(0)
0	0	0	1	INIT(1)
0	0	1	0	INIT(2)
0	0	1	1	INIT(3)
0	1	0	0	INIT(4)
0	1	0	1	INIT(5)
0	1	1	0	INIT(6)
0	1	1	1	INIT(7)
1	0	0	0	INIT(8)
1	0	0	1	INIT(9)
1	0	1	0	INIT(10)
1	0	1	1	INIT(11)
1	1	0	0	INIT(12)
1	1	0	1	INIT(13)
1	1	1	0	INIT(14)
1	1	1	1	INIT(15)

### Design Entry Method

This design element can be used in schematics.

## Available Attributes

Attribute	Data Type	Allowed Values	Default	Description
INIT	Hexadecimal	Any 128-Bit Value	All zeros	Specifies the contents of the ROM.

## For More Information

See the [Spartan-6 FPGA User Documentation \(User Guides and Data Sheets\)](#).

## ROM256X1

Primitive: 256-Deep by 1-Wide ROM

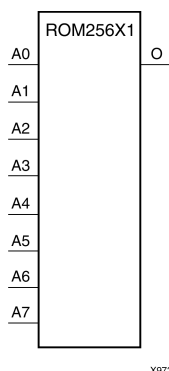

### Introduction

This design element is a 256-word by 1-bit read-only memory. The data output (O) reflects the word selected by the 8-bit address (A7:A0). The ROM is initialized to a known value during configuration with the INIT=value parameter. The value consists of 64 hexadecimal digits that are written into the ROM from the most-significant digit A=FH to the least-significant digit A=0H.

An error occurs if the INIT=value is not specified.

### Logic Table

Input				Output
I0	I1	I2	I3	O
0	0	0	0	INIT(0)
0	0	0	1	INIT(1)
0	0	1	0	INIT(2)
0	0	1	1	INIT(3)
0	1	0	0	INIT(4)
0	1	0	1	INIT(5)
0	1	1	0	INIT(6)
0	1	1	1	INIT(7)
1	0	0	0	INIT(8)
1	0	0	1	INIT(9)
1	0	1	0	INIT(10)
1	0	1	1	INIT(11)
1	1	0	0	INIT(12)
1	1	0	1	INIT(13)
1	1	1	0	INIT(14)
1	1	1	1	INIT(15)

## Design Entry Method

This design element can be used in schematics.

### Available Attributes

Attribute	Data Type	Allowed Values	Default	Description
INIT	Hexadecimal	Any 256-Bit Value	All zeros	Specifies the contents of the ROM.

### For More Information

See the [Spartan-6 FPGA User Documentation \(User Guides and Data Sheets\)](#).

## ROM32X1

### Primitive: 32-Deep by 1-Wide ROM

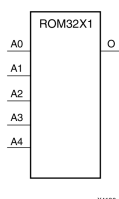

## Introduction

This design element is a 32-word by 1-bit read-only memory. The data output (O) reflects the word selected by the 5-bit address (A4:A0). The ROM is initialized to a known value during configuration with the INIT=value parameter. The value consists of eight hexadecimal digits that are written into the ROM from the most-significant digit A=1FH to the least-significant digit A=00H.

For example, the INIT=10A78F39 parameter produces the data stream: 0001 0000 1010 0111 1000 1111 0011 1001. An error occurs if the INIT=value is not specified.

## Logic Table

Input				Output
I0	I1	I2	I3	O
0	0	0	0	INIT(0)
0	0	0	1	INIT(1)
0	0	1	0	INIT(2)
0	0	1	1	INIT(3)
0	1	0	0	INIT(4)
0	1	0	1	INIT(5)
0	1	1	0	INIT(6)
0	1	1	1	INIT(7)
1	0	0	0	INIT(8)
1	0	0	1	INIT(9)
1	0	1	0	INIT(10)
1	0	1	1	INIT(11)
1	1	0	0	INIT(12)
1	1	0	1	INIT(13)
1	1	1	0	INIT(14)
1	1	1	1	INIT(15)

## Design Entry Method

This design element can be used in schematics.

## Available Attributes

Attribute	Type	Allowed Values	Default	Description
INIT	Hexadecimal	Any 32-Bit Value	All zeros	Specifies the contents of the ROM.

## For More Information

See the [Spartan-6 FPGA User Documentation \(User Guides and Data Sheets\)](#).

## ROM64X1

Primitive: 64-Deep by 1-Wide ROM

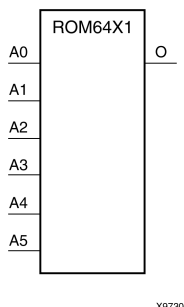

### Introduction

This design element is a 64-word by 1-bit read-only memory. The data output (O) reflects the word selected by the 6-bit address (A5:A0). The ROM is initialized to a known value during configuration with the INIT=value parameter. The value consists of 16 hexadecimal digits that are written into the ROM from the most-significant digit A=FH to the least-significant digit A=0H. An error occurs if the INIT=value is not specified.

### Logic Table

Input				Output
I0	I1	I2	I3	O
0	0	0	0	INIT(0)
0	0	0	1	INIT(1)
0	0	1	0	INIT(2)
0	0	1	1	INIT(3)
0	1	0	0	INIT(4)
0	1	0	1	INIT(5)
0	1	1	0	INIT(6)
0	1	1	1	INIT(7)
1	0	0	0	INIT(8)
1	0	0	1	INIT(9)
1	0	1	0	INIT(10)
1	0	1	1	INIT(11)
1	1	0	0	INIT(12)
1	1	0	1	INIT(13)
1	1	1	0	INIT(14)
1	1	1	1	INIT(15)

### Design Entry Method

This design element can be used in schematics.



## Available Attributes

Attribute	Data Type	Allowed Values	Default	Description
INIT	Hexadecimal	Any 64-Bit Value	All zeros	Specifies the contents of the ROM.

## For More Information

See the [Spartan-6 FPGA User Documentation \(User Guides and Data Sheets\)](#).

## SOP3

### Macro: 3-Input Sum of Products

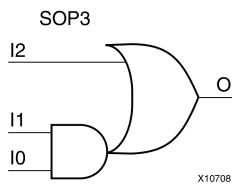

## Introduction

Three input Sum of Products (SOP) macros provide common logic functions by OR gating the output of one AND function with one direct input. Variations of inverting and non-inverting inputs are available.

## Design Entry Method

This design element is only for use in schematics.

## For More Information

See the [Spartan-6 FPGA User Documentation \(User Guides and Data Sheets\)](#).

## SOP3B1A

Macro: 3-Input Sum of Products with One Inverted Input (Option A)

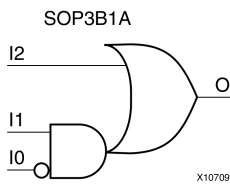

### Introduction

Three input Sum of Products (SOP) macros provide common logic functions by OR gating the output of one AND function with one direct input. Variations of inverting and non-inverting inputs are available.

### Design Entry Method

This design element is only for use in schematics.

### For More Information

See the [Spartan-6 FPGA User Documentation \(User Guides and Data Sheets\)](#).

## SOP3B1B

Macro: 3-Input Sum of Products with One Inverted Input (Option B)

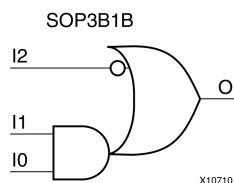

### Introduction

Three input Sum of Products (SOP) macros provide common logic functions by OR gating the output of one AND function with one direct input. Variations of inverting and non-inverting inputs are available.

### Design Entry Method

This design element is only for use in schematics.

### For More Information

See the [Spartan-6 FPGA User Documentation \(User Guides and Data Sheets\)](#).

## SOP3B2A

### Macro: 3-Input Sum of Products with Two Inverted Inputs (Option A)

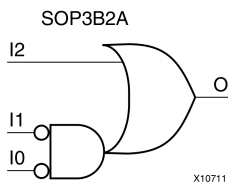

## Introduction

Three input Sum of Products (SOP) macros provide common logic functions by OR gating the output of one AND function with one direct input. Variations of inverting and non-inverting inputs are available.

## Design Entry Method

This design element is only for use in schematics.

## For More Information

See the [Spartan-6 FPGA User Documentation \(User Guides and Data Sheets\)](#).

## SOP3B2B

### Macro: 3-Input Sum of Products with Two Inverted Inputs (Option B)

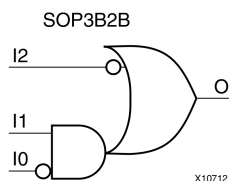

## Introduction

Three input Sum of Products (SOP) macros provide common logic functions by OR gating the output of one AND function with one direct input. Variations of inverting and non-inverting inputs are available.

## Design Entry Method

This design element is only for use in schematics.

## For More Information

See the [Spartan-6 FPGA User Documentation \(User Guides and Data Sheets\)](#).

## SOP3B3

### Macro: 3-Input Sum of Products with Inverted Inputs

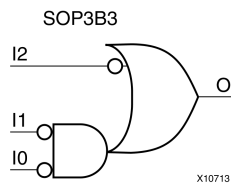

## Introduction

Three input Sum of Products (SOP) macros provide common logic functions by OR gating the output of one AND function with one direct input. Variations of inverting and non-inverting inputs are available.

## Design Entry Method

This design element is only for use in schematics.

## For More Information

See the [Spartan-6 FPGA User Documentation \(User Guides and Data Sheets\)](#).

## SOP4

### Macro: 4-Input Sum of Products

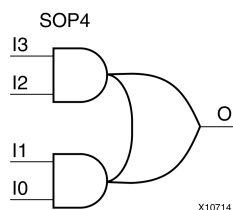

## Introduction

Four input Sum of Products (SOP) macros provide common logic functions by OR gating the outputs of two AND functions. Variations of inverting and non-inverting inputs are available.

## Design Entry Method

This design element is only for use in schematics.

## For More Information

See the [Spartan-6 FPGA User Documentation \(User Guides and Data Sheets\)](#).



## SOP4B1

Macro: 4–Input Sum of Products with One Inverted Input

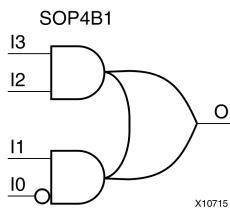

### Introduction

Four input Sum of Products (SOP) macros provide common logic functions by OR gating the outputs of two AND functions. Variations of inverting and non-inverting inputs are available.

### Design Entry Method

This design element is only for use in schematics.

### For More Information

See the [Spartan-6 FPGA User Documentation \(User Guides and Data Sheets\)](#).

## SOP4B2A

### Macro: 4-Input Sum of Products with Two Inverted Inputs (Option A)

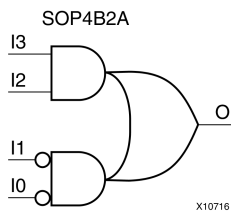

## Introduction

Four input Sum of Products (SOP) macros provide common logic functions by OR gating the outputs of two AND functions. Variations of inverting and non-inverting inputs are available.

## Design Entry Method

This design element is only for use in schematics.

## For More Information

See the [Spartan-6 FPGA User Documentation \(User Guides and Data Sheets\)](#).

## SOP4B2B

Macro: 4-Input Sum of Products with Two Inverted Inputs (Option B)

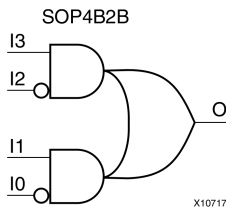

### Introduction

Four input Sum of Products (SOP) macros provide common logic functions by OR gating the outputs of two AND functions. Variations of inverting and non-inverting inputs are available.

### Design Entry Method

This design element is only for use in schematics.

### For More Information

See the [Spartan-6 FPGA User Documentation \(User Guides and Data Sheets\)](#).

## SOP4B3

### Macro: 4-Input Sum of Products with Three Inverted Inputs

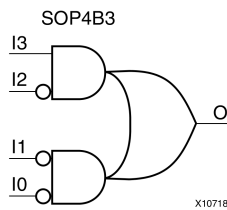

## Introduction

Four input Sum of Products (SOP) macros provide common logic functions by OR gating the outputs of two AND functions. Variations of inverting and non-inverting inputs are available.

## Design Entry Method

This design element is only for use in schematics.

## For More Information

See the [Spartan-6 FPGA User Documentation \(User Guides and Data Sheets\)](#).

## SOP4B4

### Macro: 4-Input Sum of Products with Inverted Inputs

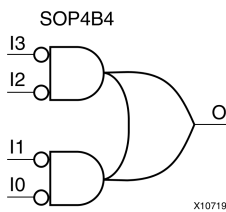

## Introduction

Four input Sum of Products (SOP) macros provide common logic functions by OR gating the outputs of two AND functions. Variations of inverting and non-inverting inputs are available.

## Design Entry Method

This design element is only for use in schematics.

## For More Information

See the [Spartan-6 FPGA User Documentation \(User Guides and Data Sheets\)](#).

## SR16CE

### Macro: 16-Bit Serial-In Parallel-Out Shift Register with Clock Enable and Asynchronous Clear

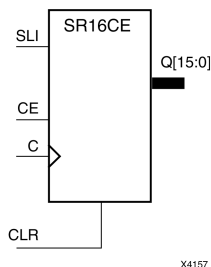

## Introduction

This design element is a shift register with a shift-left serial input (SLI), parallel outputs (Q), and clock enable (CE) and asynchronous clear (CLR) inputs. The (CLR) input, when High, overrides all other inputs and resets the data outputs (Q) Low. When (CE) is High and (CLR) is Low, the data on the SLI input is loaded into the first bit of the shift register during the Low-to-High clock (C) transition and appears on the (Q0) output. During subsequent Low-to-High clock transitions, when (CE) is High and (CLR) is Low, data shifts to the next highest bit position as new data is loaded into (Q0) (SLI into Q0, Q0 into Q1, Q1 into Q2, and so forth). The register ignores clock transitions when (CE) is Low.

Registers can be cascaded by connecting the last (Q) output of one stage to the SLI input of the next stage and connecting clock, (CE), and (CLR) in parallel.

This register is asynchronously cleared, outputs Low, when power is applied. For FPGA devices, power-on conditions are simulated when global set/reset (GSR) is active. GSR defaults to active-High but can be inverted by adding an inverter in front of the GSR input of the appropriate `STARTUP_architecture` symbol.

## Logic Table

Inputs				Outputs	
CLR	CE	SLI	C	Q0	Qz : Q1
1	X	X	X	0	0
0	0	X	X	No Change	No Change
0	1	SLI	↑	SLI	qn-1

z = bit width - 1  
qn-1 = state of referenced output one setup time prior to active clock transition

## Design Entry Method

This design element is only for use in schematics.

## For More Information

See the [Spartan-6 FPGA User Documentation \(User Guides and Data Sheets\)](#).

# SR16CLE

Macro: 16-Bit Loadable Serial/Parallel-In Parallel-Out Shift Register with Clock Enable and Asynchronous Clear

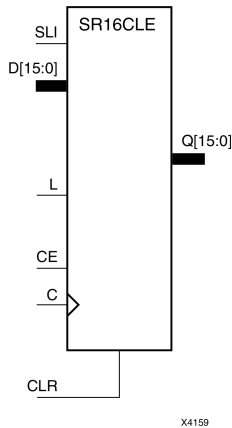

## Introduction

This design element is a shift register with a shift-left serial input (SLI), parallel inputs (D), parallel outputs (Q), and three control inputs: clock enable (CE), load enable (L), and asynchronous clear (CLR). The register ignores clock transitions when (L) and (CE) are Low. The asynchronous (CLR), when High, overrides all other inputs and resets the data outputs (Q) Low. When (L) is High and (CLR) is Low, data on the Dn -D0 inputs is loaded into the corresponding Qn -(Q0) bits of the register.

When (CE) is High and (L) and (CLR) are Low, data on the SLI input is loaded into the first bit of the shift register during the Low-to-High clock (C) transition and appears on the (Q0) output. During subsequent clock transitions, when (CE) is High and (L) and (CLR) are Low, the data shifts to the next highest bit position as new data is loaded into (Q)0 (SLI into Q0, Q0 into Q1, Q1 into Q2, and so forth).

Registers can be cascaded by connecting the last (Q) output of one stage to the SLI input of the next stage and connecting clock, (CE), (L), and (CLR) inputs in parallel.

This register is asynchronously cleared, outputs Low, when power is applied. For FPGA devices, power-on conditions are simulated when global set/reset (GSR) is active. GSR defaults to active-High but can be inverted by adding an inverter in front of the GSR input of the appropriate STARTUP\_architecture symbol.

## Logic Table

Inputs						Outputs	
CLR	L	CE	SLI	Dn : D0	C	Q0	Qz : Q1
1	X	X	X	X	X	0	0
0	1	X	X	Dn : D0	↑	D0	Dn
0	0	1	SLI	X	↑	SLI	qn-1
0	0	0	X	X	X	No Change	No Change

z = bitwidth -1  
qn-1 = state of referenced output one setup time prior to active clock transition

## Design Entry Method

This design element is only for use in schematics.

## For More Information

See the [Spartan-6 FPGA User Documentation \(User Guides and Data Sheets\)](#).



# SR16CLED

## Macro: 16-Bit Shift Register with Clock Enable and Asynchronous Clear

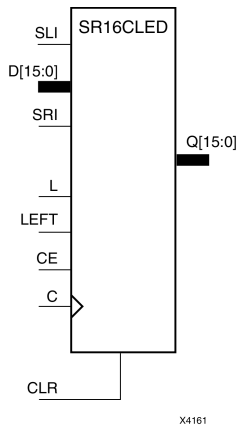

### Introduction

This design element is a shift register with shift-left (SLI) and shift-right (SRI) serial inputs, parallel inputs (D), parallel outputs (Q), and four control inputs: clock enable (CE), load enable (L), shift left/right (LEFT), and asynchronous clear (CLR). The register ignores clock transitions when (CE) and (L) are Low. The asynchronous clear, when High, overrides all other inputs and resets the data outputs (Qn) Low.

When (L) is High and (CLR) is Low, the data on the (D) inputs is loaded into the corresponding (Q) bits of the register. When (CE) is High and (L) and (CLR) are Low, data is shifted right or left, depending on the state of the LEFT input. If LEFT is High, data on the SLI is loaded into (Q0) during the Low-to-High clock transition and shifted left (for example, to Q1 or Q2) during subsequent clock transitions. If LEFT is Low, data on the SRI is loaded into the last (Q) output during the Low-to-High clock transition and shifted right during subsequent clock transitions. The logic tables indicate the state of the (Q) outputs under all input conditions.

This register is asynchronously cleared, outputs Low, when power is applied. For FPGA devices, power-on conditions are simulated when global set/reset (GSR) is active. GSR defaults to active-High but can be inverted by adding an inverter in front of the GSR input of the appropriate STARTUP\_architecture symbol.

### Logic Table

Inputs								Outputs		
CLR	L	CE	LEFT	SLI	SRI	D15 : D0	C	Q0	Q15	Q14 : Q1
1	X	X	X	X	X	X	X	0	0	0
0	1	X	X	X	X	D15 : D0	↑	D0	D15	Dn
0	0	0	X	X	X	X	X	No Change	No Change	No Change
0	0	1	1	SLI	X	X	↑	SLI	q14	qn-1
0	0	1	0	X	SRI	X	↑	q1	SRI	qn+1

qn-1 or qn+1 = state of referenced output one setup time prior to active clock transition.

### Design Entry Method

This design element is only for use in schematics.

## For More Information

See the [Spartan-6 FPGA User Documentation \(User Guides and Data Sheets\)](#).

## SR16RE

### Macro: 16-Bit Serial-In Parallel-Out Shift Register with Clock Enable and Synchronous Reset

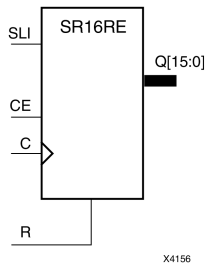

## Introduction

This design element is a shift register with shift-left serial input (SLI), parallel outputs (Qn), clock enable (CE), and synchronous reset (R) inputs. The R input, when High, overrides all other inputs during the Low-to-High clock (C) transition and resets the data outputs (Q) Low.

When (CE) is High and (R) is Low, the data on the (SLI) is loaded into the first bit of the shift register during the Low-to-High clock (C) transition and appears on the (Q0) output. During subsequent Low-to-High clock transitions, when (CE) is High and R is Low, data shifts to the next highest bit position as new data is loaded into (Q0) (SLI into Q0, Q0 into Q1, Q1 into Q2, and so forth). The register ignores clock transitions when (CE) is Low.

Registers can be cascaded by connecting the last (Q) output of one stage to the SLI input of the next stage and connecting clock, (CE), and (R) in parallel.

This register is asynchronously cleared, outputs Low, when power is applied. For FPGA devices, power-on conditions are simulated when global set/reset (GSR) is active. GSR defaults to active-High but can be inverted by adding an inverter in front of the GSR input of the appropriate STARTUP\_architecture symbol.

## Logic Table

Inputs				Outputs	
R	CE	SLI	C	Q0	Qz : Q1
1	X	X	↑	0	0
0	0	X	X	No Change	No Change
0	1	SLI	↑	SLI	qn-1

z = bitwidth -1  
qn-1 = state of referenced output one setup time prior to active clock transition

## Design Entry Method

This design element is only for use in schematics.

## For More Information

See the [Spartan-6 FPGA User Documentation \(User Guides and Data Sheets\)](#).

## SR16RLE

Macro: 16-Bit Loadable Serial/Parallel-In Parallel-Out Shift Register with Clock Enable and Synchronous Reset

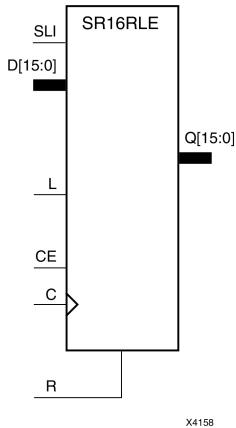

### Introduction

This design element is a shift register with shift-left serial input (SLI), parallel inputs (D), parallel outputs (Q), and three control inputs: clock enable (CE), load enable (L), and synchronous reset (R). The register ignores clock transitions when (L) and (CE) are Low. The synchronous (R), when High, overrides all other inputs during the Low-to-High clock (C) transition and resets the data outputs (Q) Low. When (L) is High and (R) is Low during the Low-to-High clock transition, data on the (D) inputs is loaded into the corresponding Q bits of the register.

When (CE) is High and (L) and (R) are Low, data on the (SLI) input is loaded into the first bit of the shift register during the Low-to-High clock (C) transition and appears on the Q0 output. During subsequent clock transitions, when (CE) is High and (L) and (R) are Low, the data shifts to the next highest bit position as new data is loaded into Q0.

Registers can be cascaded by connecting the last Q output of one stage to the SLI input of the next stage and connecting clock, (CE), (L), and (R) inputs in parallel.

This register is asynchronously cleared, outputs Low, when power is applied. For FPGA devices, power-on conditions are simulated when global set/reset (GSR) is active. GSR defaults to active-High but can be inverted by adding an inverter in front of the GSR input of the appropriate `STARTUP_architecture` symbol.

### Logic Table

Inputs						Outputs	
R	L	CE	SLI	Dz : D0	C	Q0	Qz : Q1
1	X	X	X	X	↑	0	0
0	1	X	X	Dz : D0	↑	D0	Dn
0	0	1	SLI	X	↑	SLI	qn-1
0	0	0	X	X	X	No Change	No Change

z = bitwidth -1  
qn-1 = state of referenced output one setup time prior to active clock transition

### Design Entry Method

This design element is only for use in schematics.

## For More Information

See the [Spartan-6 FPGA User Documentation \(User Guides and Data Sheets\)](#).

## SR16RLED

### Macro: 16-Bit Shift Register with Clock Enable and Synchronous Reset

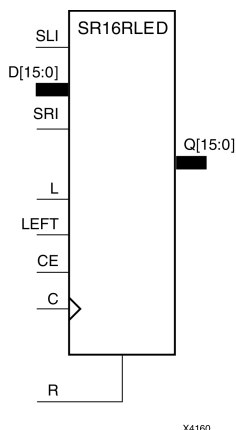

## Introduction

This design element is a shift register with shift-left (SLI) and shift-right (SRI) serial inputs, parallel inputs (D), parallel outputs (Q) and four control inputs - clock enable (CE), load enable (L), shift left/right (LEFT), and synchronous reset (R). The register ignores clock transitions when (CE) and (L) are Low. The synchronous (R), when High, overrides all other inputs during the Low-to-High clock (C) transition and resets the data outputs (Q) Low. When (L) is High and (R) is Low during the Low-to-High clock transition, the data on the (D) inputs is loaded into the corresponding (Q) bits of the register.

When (CE) is High and (L) and (R) are Low, data shifts right or left, depending on the state of the LEFT input. If LEFT is High, data on (SLI) is loaded into (Q0) during the Low-to-High clock transition and shifted left (for example, to Q1 and Q2) during subsequent clock transitions. If LEFT is Low, data on the (SRI) is loaded into the last (Q) output during the Low-to-High clock transition and shifted right ) during subsequent clock transitions. The logic tables below indicates the state of the (Q) outputs under all input conditions.

This register is asynchronously cleared, outputs Low, when power is applied. For FPGA devices, power-on conditions are simulated when global set/reset (GSR) is active. GSR defaults to active-High but can be inverted by adding an inverter in front of the GSR input of the appropriate STARTUP\_architecture symbol.

## Logic Table

Inputs								Outputs		
R	L	CE	LEFT	SLI	SRI	D15:D0	C	Q0	Q15	Q14:Q1
1	X	X	X	X	X	X	↑	0	0	0
0	1	X	X	X	X	D15:D0	↓	D0	D15	Dn
0	0	0	X	X	X	X	X	No Change	No Change	No Change
0	0	1	1	SLI	X	X	↑	SLI	q14	qn-1
0	0	1	0	X	SRI	X	↓	q1	SRI	qn+1

qn-1 or qn+1 = state of referenced output one setup time prior to active clock transition

## Design Entry Method

This design element is only for use in schematics.

## For More Information

See the [Spartan-6 FPGA User Documentation \(User Guides and Data Sheets\)](#).

## SR4CE

### Macro: 4-Bit Serial-In Parallel-Out Shift Register with Clock Enable and Asynchronous Clear

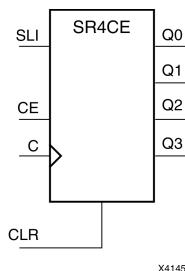

## Introduction

This design element is a shift register with a shift-left serial input (SLI), parallel outputs (Q), and clock enable (CE) and asynchronous clear (CLR) inputs. The (CLR) input, when High, overrides all other inputs and resets the data outputs (Q) Low. When (CE) is High and (CLR) is Low, the data on the SLI input is loaded into the first bit of the shift register during the Low-to-High clock (C) transition and appears on the (Q0) output. During subsequent Low-to-High clock transitions, when (CE) is High and (CLR) is Low, data shifts to the next highest bit position as new data is loaded into (Q0) (SLI into Q0, Q0 into Q1, Q1 into Q2, and so forth). The register ignores clock transitions when (CE) is Low.

Registers can be cascaded by connecting the last (Q) output of one stage to the SLI input of the next stage and connecting clock, (CE), and (CLR) in parallel.

This register is asynchronously cleared, outputs Low, when power is applied. For FPGA devices, power-on conditions are simulated when global set/reset (GSR) is active. GSR defaults to active-High but can be inverted by adding an inverter in front of the GSR input of the appropriate `STARTUP_architecture` symbol.

## Logic Table

Inputs				Outputs	
CLR	CE	SLI	C	Q0	Qz : Q1
1	X	X	X	0	0
0	0	X	X	No Change	No Change
0	1	SLI	↑	SLI	qn-1

z = bit width - 1  
qn-1 = state of referenced output one setup time prior to active clock transition

## Design Entry Method

This design element is only for use in schematics.

## For More Information

See the [Spartan-6 FPGA User Documentation \(User Guides and Data Sheets\)](#).



# SR4CLE

Macro: 4-Bit Loadable Serial/Parallel-In Parallel-Out Shift Register with Clock Enable and Asynchronous Clear

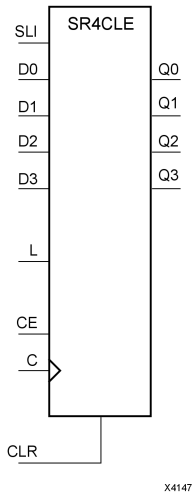

## Introduction

This design element is a shift register with a shift-left serial input (SLI), parallel inputs (D), parallel outputs (Q), and three control inputs: clock enable (CE), load enable (L), and asynchronous clear (CLR). The register ignores clock transitions when (L) and (CE) are Low. The asynchronous (CLR), when High, overrides all other inputs and resets the data outputs (Q) Low. When (L) is High and (CLR) is Low, data on the Dn -D0 inputs is loaded into the corresponding Qn -(Q0) bits of the register.

When (CE) is High and (L) and (CLR) are Low, data on the SLI input is loaded into the first bit of the shift register during the Low-to-High clock (C) transition and appears on the (Q0) output. During subsequent clock transitions, when (CE) is High and (L) and (CLR) are Low, the data shifts to the next highest bit position as new data is loaded into (Q)0 (SLI into Q0, Q0 into Q1, Q1 into Q2, and so forth).

Registers can be cascaded by connecting the last (Q) output of one stage to the SLI input of the next stage and connecting clock, (CE), (L), and (CLR) inputs in parallel.

This register is asynchronously cleared, outputs Low, when power is applied. For FPGA devices, power-on conditions are simulated when global set/reset (GSR) is active. GSR defaults to active-High but can be inverted by adding an inverter in front of the GSR input of the appropriate STARTUP\_architecture symbol.

## Logic Table

Inputs						Outputs	
CLR	L	CE	SLI	Dn : D0	C	Q0	Qz : Q1
1	X	X	X	X	X	0	0
0	1	X	X	Dn : D0	↑	D0	Dn
0	0	1	SLI	X	↑	SLI	qn-1
0	0	0	X	X	X	No Change	No Change

z = bitwidth -1  
qn-1 = state of referenced output one setup time prior to active clock transition

## Design Entry Method

This design element is only for use in schematics.

## For More Information

See the [Spartan-6 FPGA User Documentation \(User Guides and Data Sheets\)](#).

# SR4CLED

## Macro: 4-Bit Shift Register with Clock Enable and Asynchronous Clear

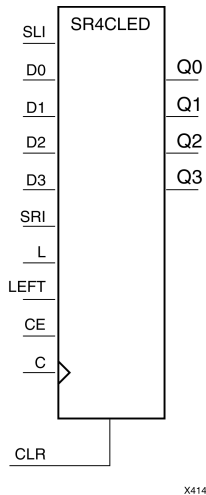

### Introduction

This design element is a shift register with shift-left (SLI) and shift-right (SRI) serial inputs, parallel inputs (D), parallel outputs (Q), and four control inputs: clock enable (CE), load enable (L), shift left/right (LEFT), and asynchronous clear (CLR). The register ignores clock transitions when (CE) and (L) are Low. The asynchronous clear, when High, overrides all other inputs and resets the data outputs (Qn) Low.

When (L) is High and (CLR) is Low, the data on the (D) inputs is loaded into the corresponding (Q) bits of the register. When (CE) is High and (L) and (CLR) are Low, data is shifted right or left, depending on the state of the LEFT input. If LEFT is High, data on the SLI is loaded into (Q0) during the Low-to-High clock transition and shifted left (for example, to Q1 or Q2) during subsequent clock transitions. If LEFT is Low, data on the SRI is loaded into the last (Q) output during the Low-to-High clock transition and shifted right during subsequent clock transitions. The logic tables indicate the state of the (Q) outputs under all input conditions.

This register is asynchronously cleared, outputs Low, when power is applied. For FPGA devices, power-on conditions are simulated when global set/reset (GSR) is active. GSR defaults to active-High but can be inverted by adding an inverter in front of the GSR input of the appropriate STARTUP\_architecture symbol.

### Logic Table

Inputs								Outputs		
CLR	L	CE	LEFT	SLI	SRI	D3 : D0	C	Q0	Q3	Q2 : Q1
1	X	X	X	X	X	X	X	0	0	0
0	1	X	X	X	X	D3– D0	↑	D0	D3	Dn
0	0	0	X	X	X	X	X	No Change	No Change	No Change
0	0	1	1	SLI	X	X	↑	SLI	q2	qn-1
0	0	1	0	X	SRI	X	↑	q1	SRI	qn+1

qn-1 and qn+1 = state of referenced output one setup time prior to active clock transition.

### Design Entry Method

This design element is only for use in schematics.

## For More Information

See the [Spartan-6 FPGA User Documentation \(User Guides and Data Sheets\)](#).

## SR4RE

### Macro: 4-Bit Serial-In Parallel-Out Shift Register with Clock Enable and Synchronous Reset

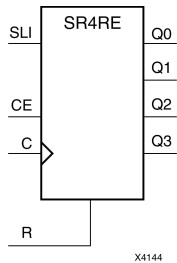

## Introduction

This design element is a shift register with shift-left serial input (SLI), parallel outputs (Qn), clock enable (CE), and synchronous reset (R) inputs. The R input, when High, overrides all other inputs during the Low-to-High clock (C) transition and resets the data outputs (Q) Low.

When (CE) is High and (R) is Low, the data on the (SLI) is loaded into the first bit of the shift register during the Low-to-High clock (C) transition and appears on the (Q0) output. During subsequent Low-to-High clock transitions, when (CE) is High and R is Low, data shifts to the next highest bit position as new data is loaded into (Q0) (SLI into Q0, Q0 into Q1, Q1 into Q2, and so forth). The register ignores clock transitions when (CE) is Low.

Registers can be cascaded by connecting the last (Q) output of one stage to the SLI input of the next stage and connecting clock, (CE), and (R) in parallel.

This register is asynchronously cleared, outputs Low, when power is applied. For FPGA devices, power-on conditions are simulated when global set/reset (GSR) is active. GSR defaults to active-High but can be inverted by adding an inverter in front of the GSR input of the appropriate `STARTUP_architecture` symbol.

## Logic Table

Inputs				Outputs	
R	CE	SLI	C	Q0	Qz : Q1
1	X	X	↑	0	0
0	0	X	X	No Change	No Change
0	1	SLI	↑	SLI	qn-1
z = bitwidth -1					
qn-1 = state of referenced output one setup time prior to active clock transition					

## Design Entry Method

This design element is only for use in schematics.

## For More Information

See the [Spartan-6 FPGA User Documentation \(User Guides and Data Sheets\)](#).

## SR4RLE

### Macro: 4-Bit Loadable Serial/Parallel-In Parallel-Out Shift Register with Clock Enable and Synchronous Reset

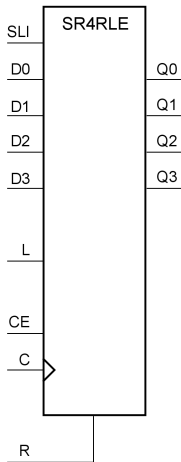

X4146

## Introduction

This design element is a shift register with shift-left serial input (SLI), parallel inputs (D), parallel outputs (Q), and three control inputs: clock enable (CE), load enable (L), and synchronous reset (R). The register ignores clock transitions when (L) and (CE) are Low. The synchronous (R), when High, overrides all other inputs during the Low-to-High clock (C) transition and resets the data outputs (Q) Low. When (L) is High and (R) is Low during the Low-to-High clock transition, data on the (D) inputs is loaded into the corresponding Q bits of the register.

When (CE) is High and (L) and (R) are Low, data on the (SLI) input is loaded into the first bit of the shift register during the Low-to-High clock (C) transition and appears on the Q0 output. During subsequent clock transitions, when (CE) is High and (L) and (R) are Low, the data shifts to the next highest bit position as new data is loaded into Q0.

Registers can be cascaded by connecting the last Q output of one stage to the SLI input of the next stage and connecting clock, (CE), (L), and (R) inputs in parallel.

This register is asynchronously cleared, outputs Low, when power is applied. For FPGA devices, power-on conditions are simulated when global set/reset (GSR) is active. GSR defaults to active-High but can be inverted by adding an inverter in front of the GSR input of the appropriate *STARTUP\_architecture* symbol.

## Logic Table

Inputs						Outputs	
R	L	CE	SLI	Dz : D0	C	Q0	Qz : Q1
1	X	X	X	X	↑	0	0
0	1	X	X	Dz : D0	↑	D0	Dn
0	0	1	SLI	X	↑	SLI	qn-1
0	0	0	X	X	X	No Change	No Change

z = bitwidth -1  
qn-1 = state of referenced output one setup time prior to active clock transition

## Design Entry Method

This design element is only for use in schematics.

## For More Information

See the [Spartan-6 FPGA User Documentation \(User Guides and Data Sheets\)](#).

## SR4RLED

### Macro: 4-Bit Shift Register with Clock Enable and Synchronous Reset

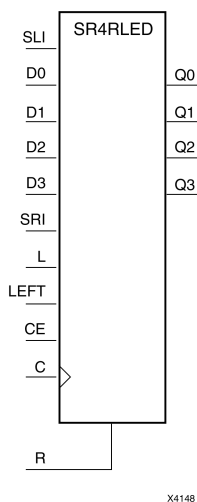

## Introduction

This design element is a shift register with shift-left (SLI) and shift-right (SRI) serial inputs, parallel inputs (D), parallel outputs (Q) and four control inputs - clock enable (CE), load enable (L), shift left/right (LEFT), and synchronous reset (R). The register ignores clock transitions when (CE) and (L) are Low. The synchronous (R), when High, overrides all other inputs during the Low-to-High clock (C) transition and resets the data outputs (Q) Low. When (L) is High and (R) is Low during the Low-to-High clock transition, the data on the (D) inputs is loaded into the corresponding (Q) bits of the register.

When (CE) is High and (L) and (R) are Low, data shifts right or left, depending on the state of the LEFT input. If LEFT is High, data on (SLI) is loaded into (Q0) during the Low-to-High clock transition and shifted left (for example, to Q1 and Q2) during subsequent clock transitions. If LEFT is Low, data on the (SRI) is loaded into the last (Q) output during the Low-to-High clock transition and shifted right ) during subsequent clock transitions. The logic tables below indicates the state of the (Q) outputs under all input conditions.

This register is asynchronously cleared, outputs Low, when power is applied. For FPGA devices, power-on conditions are simulated when global set/reset (GSR) is active. GSR defaults to active-High but can be inverted by adding an inverter in front of the GSR input of the appropriate STARTUP\_architecture symbol.

## Logic Table

Inputs								Outputs		
R	L	CE	LEFT	SLI	SRI	D3 : D0	C	Q0	Q3	Q2 : Q1
1	X	X	X	X	X	X	↑	0	0	0
0	1	X	X	X	X	D3 : D0	↑	D0	D3	Dn
0	0	0	X	X	X	X	X	No Change	No Change	No Change
0	0	1	1	SLI	X	X	↑	SLI	q2	qn-1
0	0	1	0	X	SRI	X	↑	q1	SRI	qn+1

qn-1 or qn+1 = state of referenced output one setup time prior to active clock transition



## Design Entry Method

This design element is only for use in schematics.

## For More Information

See the [Spartan-6 FPGA User Documentation \(User Guides and Data Sheets\)](#).

## SR8CE

### Macro: 8-Bit Serial-In Parallel-Out Shift Register with Clock Enable and Asynchronous Clear

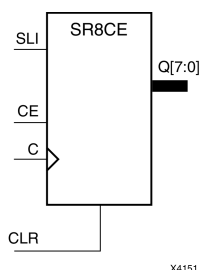

## Introduction

This design element is a shift register with a shift-left serial input (SLI), parallel outputs (Q), and clock enable (CE) and asynchronous clear (CLR) inputs. The (CLR) input, when High, overrides all other inputs and resets the data outputs (Q) Low. When (CE) is High and (CLR) is Low, the data on the SLI input is loaded into the first bit of the shift register during the Low-to-High clock (C) transition and appears on the (Q0) output. During subsequent Low-to-High clock transitions, when (CE) is High and (CLR) is Low, data shifts to the next highest bit position as new data is loaded into (Q0) (SLI into Q0, Q0 into Q1, Q1 into Q2, and so forth). The register ignores clock transitions when (CE) is Low.

Registers can be cascaded by connecting the last (Q) output of one stage to the SLI input of the next stage and connecting clock, (CE), and (CLR) in parallel.

This register is asynchronously cleared, outputs Low, when power is applied. For FPGA devices, power-on conditions are simulated when global set/reset (GSR) is active. GSR defaults to active-High but can be inverted by adding an inverter in front of the GSR input of the appropriate `STARTUP_architecture` symbol.

## Logic Table

Inputs				Outputs	
CLR	CE	SLI	C	Q0	Qz : Q1
1	X	X	X	0	0
0	0	X	X	No Change	No Change
0	1	SLI	↑	SLI	qn-1

z = bit width - 1  
qn-1 = state of referenced output one setup time prior to active clock transition

## Design Entry Method

This design element is only for use in schematics.

## For More Information

See the [Spartan-6 FPGA User Documentation \(User Guides and Data Sheets\)](#).

## SR8CLE

Macro: 8-Bit Loadable Serial/Parallel-In Parallel-Out Shift Register with Clock Enable and Asynchronous Clear

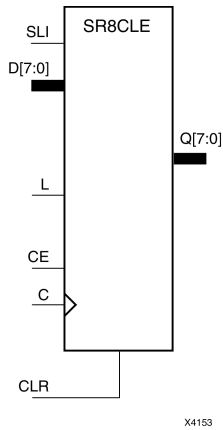

### Introduction

This design element is a shift register with a shift-left serial input (SLI), parallel inputs (D), parallel outputs (Q), and three control inputs: clock enable (CE), load enable (L), and asynchronous clear (CLR). The register ignores clock transitions when (L) and (CE) are Low. The asynchronous (CLR), when High, overrides all other inputs and resets the data outputs (Q) Low. When (L) is High and (CLR) is Low, data on the Dn -D0 inputs is loaded into the corresponding Qn -(Q0) bits of the register.

When (CE) is High and (L) and (CLR) are Low, data on the SLI input is loaded into the first bit of the shift register during the Low-to-High clock (C) transition and appears on the (Q0) output. During subsequent clock transitions, when (CE) is High and (L) and (CLR) are Low, the data shifts to the next highest bit position as new data is loaded into (Q)0 (SLI into Q0, Q0 into Q1, Q1 into Q2, and so forth).

Registers can be cascaded by connecting the last (Q) output of one stage to the SLI input of the next stage and connecting clock, (CE), (L), and (CLR) inputs in parallel.

This register is asynchronously cleared, outputs Low, when power is applied. For FPGA devices, power-on conditions are simulated when global set/reset (GSR) is active. GSR defaults to active-High but can be inverted by adding an inverter in front of the GSR input of the appropriate *STARTUP\_architecture* symbol.

### Logic Table

Inputs						Outputs	
CLR	L	CE	SLI	Dn : D0	C	Q0	Qz : Q1
1	X	X	X	X	X	0	0
0	1	X	X	Dn : D0	↑	D0	Dn
0	0	1	SLI	X	↑	SLI	qn-1
0	0	0	X	X	X	No Change	No Change

z = bitwidth -1  
qn-1 = state of referenced output one setup time prior to active clock transition

### Design Entry Method

This design element is only for use in schematics.

## For More Information

See the [Spartan-6 FPGA User Documentation \(User Guides and Data Sheets\)](#).

# SR8CLED

## Macro: 8-Bit Shift Register with Clock Enable and Asynchronous Clear

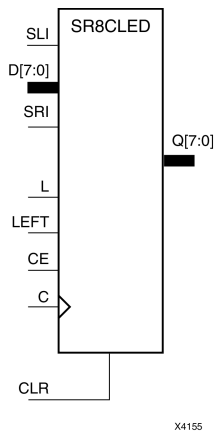

### Introduction

This design element is a shift register with shift-left (SLI) and shift-right (SRI) serial inputs, parallel inputs (D), parallel outputs (Q), and four control inputs: clock enable (CE), load enable (L), shift left/right (LEFT), and asynchronous clear (CLR). The register ignores clock transitions when (CE) and (L) are Low. The asynchronous clear, when High, overrides all other inputs and resets the data outputs (Qn) Low.

When (L) is High and (CLR) is Low, the data on the (D) inputs is loaded into the corresponding (Q) bits of the register. When (CE) is High and (L) and (CLR) are Low, data is shifted right or left, depending on the state of the LEFT input. If LEFT is High, data on the SLI is loaded into (Q0) during the Low-to-High clock transition and shifted left (for example, to Q1 or Q2) during subsequent clock transitions. If LEFT is Low, data on the SRI is loaded into the last (Q) output during the Low-to-High clock transition and shifted right during subsequent clock transitions. The logic tables indicate the state of the (Q) outputs under all input conditions.

This register is asynchronously cleared, outputs Low, when power is applied. For FPGA devices, power-on conditions are simulated when global set/reset (GSR) is active. GSR defaults to active-High but can be inverted by adding an inverter in front of the GSR input of the appropriate STARTUP\_architecture symbol.

### Logic Table

Inputs								Outputs		
CLR	L	CE	LEFT	SLI	SRI	D7 : D0	C	Q0	Q7	Q6 : Q1
1	X	X	X	X	X	X	X	0	0	0
0	1	X	X	X	X	D7 : D0	↑	D0	D7	Dn
0	0	0	X	X	X	X	X	No Change	No Change	No Change
0	0	1	1	SLI	X	X	↑	SLI	q6	qn-1
0	0	1	0	X	SRI	X	↑	q1	SRI	qn+1

qn-1 or qn+1 = state of referenced output one setup time prior to active clock transition.

### Design Entry Method

This design element is only for use in schematics.

## For More Information

See the [Spartan-6 FPGA User Documentation \(User Guides and Data Sheets\)](#).

## SR8RE

### Macro: 8-Bit Serial-In Parallel-Out Shift Register with Clock Enable and Synchronous Reset

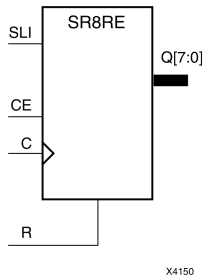

## Introduction

This design element is a shift register with shift-left serial input (SLI), parallel outputs (Qn), clock enable (CE), and synchronous reset (R) inputs. The R input, when High, overrides all other inputs during the Low-to-High clock (C) transition and resets the data outputs (Q) Low.

When (CE) is High and (R) is Low, the data on the (SLI) is loaded into the first bit of the shift register during the Low-to-High clock (C) transition and appears on the (Q0) output. During subsequent Low-to-High clock transitions, when (CE) is High and R is Low, data shifts to the next highest bit position as new data is loaded into (Q0) (SLI into Q0, Q0 into Q1, Q1 into Q2, and so forth). The register ignores clock transitions when (CE) is Low.

Registers can be cascaded by connecting the last (Q) output of one stage to the SLI input of the next stage and connecting clock, (CE), and (R) in parallel.

This register is asynchronously cleared, outputs Low, when power is applied. For FPGA devices, power-on conditions are simulated when global set/reset (GSR) is active. GSR defaults to active-High but can be inverted by adding an inverter in front of the GSR input of the appropriate *STARTUP\_architecture* symbol.

## Logic Table

Inputs				Outputs	
R	CE	SLI	C	Q0	Qz : Q1
1	X	X	↑	0	0
0	0	X	X	No Change	No Change
0	1	SLI	↑	SLI	qn-1

z = bitwidth -1  
qn-1 = state of referenced output one setup time prior to active clock transition

## Design Entry Method

This design element is only for use in schematics.

## For More Information

See the [Spartan-6 FPGA User Documentation \(User Guides and Data Sheets\)](#).

## SR8RLE

Macro: 8-Bit Loadable Serial/Parallel-In Parallel-Out Shift Register with Clock Enable and Synchronous Reset

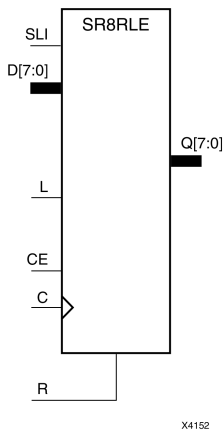

### Introduction

This design element is a shift register with shift-left serial input (SLI), parallel inputs (D), parallel outputs (Q), and three control inputs: clock enable (CE), load enable (L), and synchronous reset (R). The register ignores clock transitions when (L) and (CE) are Low. The synchronous (R), when High, overrides all other inputs during the Low-to-High clock (C) transition and resets the data outputs (Q) Low. When (L) is High and (R) is Low during the Low-to-High clock transition, data on the (D) inputs is loaded into the corresponding Q bits of the register.

When (CE) is High and (L) and (R) are Low, data on the (SLI) input is loaded into the first bit of the shift register during the Low-to-High clock (C) transition and appears on the Q0 output. During subsequent clock transitions, when (CE) is High and (L) and (R) are Low, the data shifts to the next highest bit position as new data is loaded into Q0.

Registers can be cascaded by connecting the last Q output of one stage to the SLI input of the next stage and connecting clock, (CE), (L), and (R) inputs in parallel.

This register is asynchronously cleared, outputs Low, when power is applied. For FPGA devices, power-on conditions are simulated when global set/reset (GSR) is active. GSR defaults to active-High but can be inverted by adding an inverter in front of the GSR input of the appropriate `STARTUP_architecture` symbol.

### Logic Table

Inputs						Outputs	
R	L	CE	SLI	Dz : D0	C	Q0	Qz : Q1
1	X	X	X	X	↑	0	0
0	1	X	X	Dz : D0	↑	D0	Dn
0	0	1	SLI	X	↑	SLI	qn-1
0	0	0	X	X	X	No Change	No Change

z = bitwidth -1  
qn-1 = state of referenced output one setup time prior to active clock transition

### Design Entry Method

This design element is only for use in schematics.



## For More Information

See the [Spartan-6 FPGA User Documentation \(User Guides and Data Sheets\)](#).

## SR8RLED

### Macro: 8-Bit Shift Register with Clock Enable and Synchronous Reset

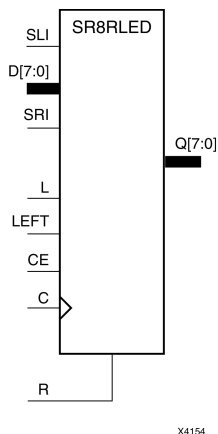

X4154

## Introduction

This design element is a shift register with shift-left (SLI) and shift-right (SRI) serial inputs, parallel inputs (D), parallel outputs (Q) and four control inputs - clock enable (CE), load enable (L), shift left/right (LEFT), and synchronous reset (R). The register ignores clock transitions when (CE) and (L) are Low. The synchronous (R), when High, overrides all other inputs during the Low-to-High clock (C) transition and resets the data outputs (Q) Low. When (L) is High and (R) is Low during the Low-to-High clock transition, the data on the (D) inputs is loaded into the corresponding (Q) bits of the register.

When (CE) is High and (L) and (R) are Low, data shifts right or left, depending on the state of the LEFT input. If LEFT is High, data on (SLI) is loaded into (Q0) during the Low-to-High clock transition and shifted left (for example, to Q1 and Q2) during subsequent clock transitions. If LEFT is Low, data on the (SRI) is loaded into the last (Q) output during the Low-to-High clock transition and shifted right ) during subsequent clock transitions. The logic tables below indicates the state of the (Q) outputs under all input conditions.

This register is asynchronously cleared, outputs Low, when power is applied. For FPGA devices, power-on conditions are simulated when global set/reset (GSR) is active. GSR defaults to active-High but can be inverted by adding an inverter in front of the GSR input of the appropriate *STARTUP\_architecture* symbol.

## Logic Table

Inputs								Outputs		
R	L	CE	LEFT	SLI	SRI	D7 : D0	C	Q0	Q7	Q6 : Q1
1	X	X	X	X	X	X	↑	0	0	0
0	1	X	X	X	X	D7 : D0	↓	D0	D7	Dn
0	0	0	X	X	X	X	X	No Change	No Change	No Change
0	0	1	1	SLI	X	X	↑	SLI	q6	qn-1
0	0	1	0	X	SRI	X	↓	q1	SRI	qn+1

qn-1 or qn+1 = state of referenced output one setup time prior to active clock transition

## Design Entry Method

This design element is only for use in schematics.

## For More Information

See the [Spartan-6 FPGA User Documentation \(User Guides and Data Sheets\)](#).

## SRL16

### Primitive: 16-Bit Shift Register Look-Up Table (LUT)

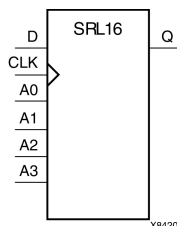

## Introduction

This design element is a shift register look-up table (LUT). The inputs A3, A2, A1, and A0 select the output length of the shift register.

The shift register can be of a fixed, static length or it can be dynamically adjusted.

- **To create a fixed-length shift register** - Drive the A3 through A0 inputs with static values. The length of the shift register can vary from 1 bit to 16 bits, as determined by the following formula:  $\text{Length} = (8 \times A3) + (4 \times A2) + (2 \times A1) + A0 + 1$ . If A3, A2, A1, and A0 are all zeros (0000), the shift register is one bit long. If they are all ones (1111), it is 16 bits long.
- **To change the length of the shift register dynamically** - Change the values driving the A3 through A0 inputs. For example, if A2, A1, and A0 are all ones (111) and A3 toggles between a one (1) and a zero (0), the length of the shift register changes from 16 bits to 8 bits. Internally, the length of the shift register is always 16 bits and the input lines A3 through A0 select which of the 16 bits reach the output.

The shift register LUT contents are initialized by assigning a four-digit hexadecimal number to an INIT attribute. The first, or the left-most, hexadecimal digit is the most significant bit. If an INIT value is not specified, it defaults to a value of four zeros (0000) so that the shift register LUT is cleared during configuration.

The data (D) is loaded into the first bit of the shift register during the Low-to-High clock (CLK) transition. During subsequent Low-to-High clock transitions data shifts to the next highest bit position while new data is loaded. The data appears on the Q output when the shift register length determined by the address inputs is reached.

## Logic Table

Inputs			Output
A <sub>m</sub>	CLK	D	Q
A <sub>m</sub>	X	X	Q(A <sub>m</sub> )
A <sub>m</sub>	↑	D	Q(A <sub>m</sub> - 1)
m = 0, 1, 2, 3			

## Design Entry Method

This design element can be used in schematics.

## Available Attributes

Attribute	Data Type	Allowed Values	Default	Description
INIT	Hexadecimal	Any 16-Bit Value	All zeros	Sets the initial value of Q output after configuration.

## For More Information

See the [Spartan-6 FPGA User Documentation \(User Guides and Data Sheets\)](#).

## SRL16\_1

### Primitive: 16-Bit Shift Register Look-Up Table (LUT) with Negative-Edge Clock

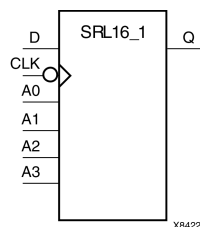

## Introduction

This design element is a shift register look-up table (LUT). The inputs A3, A2, A1, and A0 select the output length of the shift register.

The shift register can be of a fixed, static length or it can be dynamically adjusted.

- **To create a fixed-length shift register** -Drive the A3 through A0 inputs with static values. The length of the shift register can vary from 1 bit to 16 bits, as determined by the following formula:  $\text{Length} = (8 \times A3) + (4 \times A2) + (2 \times A1) + A0 + 1$ . If A3, A2, A1, and A0 are all zeros (0000), the shift register is one bit long. If they are all ones (1111), it is 16 bits long.
- **To change the length of the shift register dynamically** -Change the values driving the A3 through A0 inputs. For example, if A2, A1, and A0 are all ones (111) and A3 toggles between a one (1) and a zero (0), the length of the shift register changes from 16 bits to 8 bits. Internally, the length of the shift register is always 16 bits and the input lines A3 through A0 select which of the 16 bits reach the output.

The shift register LUT contents are initialized by assigning a four-digit hexadecimal number to an INIT attribute. The first, or the left-most, hexadecimal digit is the most significant bit. If an INIT value is not specified, it defaults to a value of four zeros (0000) so that the shift register LUT is cleared during configuration.

The data (D) is loaded into the first bit of the shift register during the High-to-Low clock (CLK) transition. During subsequent High-to-Low clock transitions data shifts to the next highest bit position as new data is loaded. The data appears on the Q output when the shift register length determined by the address inputs is reached.

## Logic Table

Inputs			Output
A <sub>m</sub>	CLK	D	Q
A <sub>m</sub>	X	X	Q(A <sub>m</sub> )
A <sub>m</sub>	↓	D	Q(A <sub>m</sub> - 1)
m = 0, 1, 2, 3			

## Design Entry Method

This design element can be used in schematics.

## Available Attributes

Attribute	Data Type	Allowed Values	Default	Description
INIT	Hexadecimal	Any 16-Bit Value	All zeros	Sets the initial value of Q output after configuration

## For More Information

See the [Spartan-6 FPGA User Documentation \(User Guides and Data Sheets\)](#).

## SRL16E

### Primitive: 16-Bit Shift Register Look-Up Table (LUT) with Clock Enable

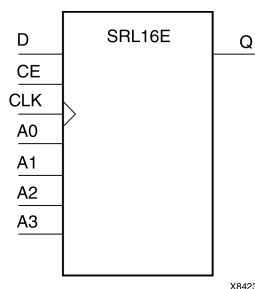

## Introduction

This design element is a shift register look-up table (LUT). The inputs A3, A2, A1, and A0 select the output length of the shift register.

The shift register can be of a fixed, static length or it can be dynamically adjusted.

- **To create a fixed-length shift register** -Drive the A3 through A0 inputs with static values. The length of the shift register can vary from 1 bit to 16 bits, as determined by the following formula:  $\text{Length} = (8 \times A3) + (4 \times A2) + (2 \times A1) + A0 + 1$ . If A3, A2, A1, and A0 are all zeros (0000), the shift register is one bit long. If they are all ones (1111), it is 16 bits long.
- **To change the length of the shift register dynamically** -Change the values driving the A3 through A0 inputs. For example, if A2, A1, and A0 are all ones (111) and A3 toggles between a one (1) and a zero (0), the length of the shift register changes from 16 bits to 8 bits. Internally, the length of the shift register is always 16 bits and the input lines A3 through A0 select which of the 16 bits reach the output.

The shift register LUT contents are initialized by assigning a four-digit hexadecimal number to an INIT attribute. The first, or the left-most, hexadecimal digit is the most significant bit. If an INIT value is not specified, it defaults to a value of four zeros (0000) so that the shift register LUT is cleared during configuration.

When CE is High, the data (D) is loaded into the first bit of the shift register during the Low-to-High clock (CLK) transition. During subsequent Low-to-High clock transitions, when CE is High, data shifts to the next highest bit position as new data is loaded. The data appears on the Q output when the shift register length determined by the address inputs is reached. When CE is Low, the register ignores clock transitions.

## Logic Table

Inputs				Output
A <sub>m</sub>	CE	CLK	D	Q
A <sub>m</sub>	0	X	X	Q(A <sub>m</sub> )
A <sub>m</sub>	1	↑	D	Q(A <sub>m</sub> - 1)
m= 0, 1, 2, 3				



## Port Descriptions

Port	Direction	Width	Function
Q	Output	1	Shift register data output
D	Input	1	Shift register data input
CLK	Input	1	Clock
CE	Input	1	Active high clock enable
A	Input	4	Dynamic depth selection of the SRL <ul style="list-style-type: none"> <li>A=0000 ==&gt; 1-bit shift length</li> <li>A=1111 ==&gt; 16-bit shift length</li> </ul>

## Design Entry Method

This design element can be used in schematics.

## Available Attributes

Attribute	Data Type	Allowed Values	Default	Description
INIT	Hexa-decimal	Any 16-Bit Value	All zeros	Sets the initial value of content and output of shift register after configuration.

## For More Information

See the [Spartan-6 FPGA User Documentation \(User Guides and Data Sheets\)](#).

## SRL16E\_1

### Primitive: 16-Bit Shift Register Look-Up Table (LUT) with Negative-Edge Clock and Clock Enable

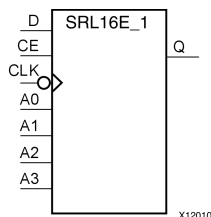

## Introduction

This design element is a shift register look-up table (LUT) with clock enable (CE). The inputs A3, A2, A1, and A0 select the output length of the shift register.

The shift register can be of a fixed, static length or it can be dynamically adjusted.

- **To create a fixed-length shift register** -Drive the A3 through A0 inputs with static values. The length of the shift register can vary from 1 bit to 16 bits, as determined by the following formula:  $\text{Length} = (8 \times A3) + (4 \times A2) + (2 \times A1) + A0 + 1$ . If A3, A2, A1, and A0 are all zeros (0000), the shift register is one bit long. If they are all ones (1111), it is 16 bits long.
- **To change the length of the shift register dynamically** -Change the values driving the A3 through A0 inputs. For example, if A2, A1, and A0 are all ones (111) and A3 toggles between a one (1) and a zero (0), the length of the shift register changes from 16 bits to 8 bits. Internally, the length of the shift register is always 16 bits and the input lines A3 through A0 select which of the 16 bits reach the output.

The shift register LUT contents are initialized by assigning a four-digit hexadecimal number to an INIT attribute. The first, or the left-most, hexadecimal digit is the most significant bit. If an INIT value is not specified, it defaults to a value of four zeros (0000) so that the shift register LUT is cleared during configuration.

When CE is High, the data (D) is loaded into the first bit of the shift register during the High-to-Low clock (CLK) transition. During subsequent High-to-Low clock transitions, when CE is High, data is shifted to the next highest bit position as new data is loaded. The data appears on the Q output when the shift register length determined by the address inputs is reached. When CE is Low, the register ignores clock transitions.

## Logic Table

Inputs				Output
A <sub>m</sub>	CE	CLK	D	Q
A <sub>m</sub>	0	X	X	Q(A <sub>m</sub> )
A <sub>m</sub>	1	↓	D	Q(A <sub>m</sub> - 1)
m = 0, 1, 2, 3				

## Design Entry Method

This design element can be used in schematics.

## Available Attributes

Attribute	Type	Allowed Values	Default	Description
INIT	Hexadecimal	Any 16-Bit Value	All zeros	Sets the initial value of content and output of shift register after configuration.

## For More Information

See the [Spartan-6 FPGA User Documentation \(User Guides and Data Sheets\)](#).

## SRLC16

### Primitive: 16-Bit Shift Register Look-Up Table (LUT) with Carry

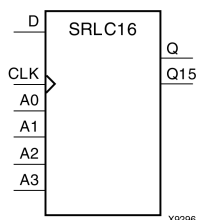

## Introduction

This design element is a shift register look-up table (LUT) with Carry. The inputs A3, A2, A1, and A0 select the output length of the shift register.

The shift register can be of a fixed, static length or it can be dynamically adjusted.

- **To create a fixed-length shift register** -Drive the A3 through A0 inputs with static values. The length of the shift register can vary from 1 bit to 16 bits, as determined by the following formula:  $\text{Length} = (8 \times A3) + (4 \times A2) + (2 \times A1) + A0 + 1$ . If A3, A2, A1, and A0 are all zeros (0000), the shift register is one bit long. If they are all ones (1111), it is 16 bits long.
- **To change the length of the shift register dynamically** -Change the values driving the A3 through A0 inputs. For example, if A2, A1, and A0 are all ones (111) and A3 toggles between a one (1) and a zero (0), the length of the shift register changes from 16 bits to 8 bits. Internally, the length of the shift register is always 16 bits and the input lines A3 through A0 select which of the 16 bits reach the output.

The shift register LUT contents are initialized by assigning a four-digit hexadecimal number to an INIT attribute. The first, or the left-most, hexadecimal digit is the most significant bit. If an INIT value is not specified, it defaults to a value of four zeros (0000) so that the shift register LUT is cleared during configuration.

The data (D) is loaded into the first bit of the shift register during the Low-to-High clock (CLK) transition. During subsequent Low-to-High clock transitions data shifts to the next highest bit position as new data is loaded. The data appears on the Q output when the shift register length determined by the address inputs is reached.

**Note** The Q15 output is available for you in cascading to multiple shift register LUTs to create larger shift registers.

## Logic Table

Inputs			Output
A <sub>m</sub>	CLK	D	Q
A <sub>m</sub>	X	X	Q(A <sub>m</sub> )
A <sub>m</sub>	↑	D	Q(A <sub>m</sub> - 1)
m = 0, 1, 2, 3			

## Design Entry Method

This design element can be used in schematics.

## Available Attributes

Attribute	Data Type	Allowed Values	Default	Description
INIT	Hexadecimal	Any 16-Bit Value	All zeros	Sets the initial value of content and output of shift register after configuration.

## For More Information

See the [Spartan-6 FPGA User Documentation \(User Guides and Data Sheets\)](#).

## SRLC16\_1

Primitive: 16-Bit Shift Register Look-Up Table (LUT) with Carry and Negative-Edge Clock

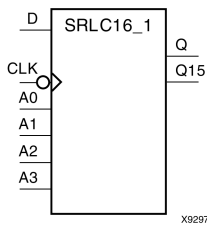

### Introduction

This design element is a shift register look-up table (LUT) with carry and a negative-edge clock. The inputs A3, A2, A1, and A0 select the output length of the shift register.

The shift register can be of a fixed, static length or it can be dynamically adjusted.

- **To create a fixed-length shift register** -Drive the A3 through A0 inputs with static values. The length of the shift register can vary from 1 bit to 16 bits, as determined by the following formula:  $\text{Length} = (8 \times A3) + (4 \times A2) + (2 \times A1) + A0 + 1$ . If A3, A2, A1, and A0 are all zeros (0000), the shift register is one bit long. If they are all ones (1111), it is 16 bits long.
- **To change the length of the shift register dynamically** -Change the values driving the A3 through A0 inputs. For example, if A2, A1, and A0 are all ones (111) and A3 toggles between a one (1) and a zero (0), the length of the shift register changes from 16 bits to 8 bits. Internally, the length of the shift register is always 16 bits and the input lines A3 through A0 select which of the 16 bits reach the output.

The shift register LUT contents are initialized by assigning a four-digit hexadecimal number to an INIT attribute. The first, or the left-most, hexadecimal digit is the most significant bit. If an INIT value is not specified, it defaults to a value of four zeros (0000) so that the shift register LUT is cleared during configuration.

**Note** The Q15 output is available for your use in cascading multiple shift register LUTs to create larger shift registers.

### Logic Table

Inputs			Output	
Am	CLK	D	Q	Q15
Am	X	X	Q(Am)	No Change
Am	↓	D	Q(Am - 1)	Q14
m = 0, 1, 2, 3				

### Design Entry Method

This design element can be used in schematics.

### Available Attributes

Attribute	Data Type	Allowed Values	Default	Description
INIT	Hexadecimal	Any 16-Bit Value	All zeros	Sets the initial value of content and output of shift register after configuration.

## For More Information

See the [Spartan-6 FPGA User Documentation \(User Guides and Data Sheets\)](#).

## SRLC16E

### Primitive: 16-Bit Shift Register Look-Up Table (LUT) with Carry and Clock Enable

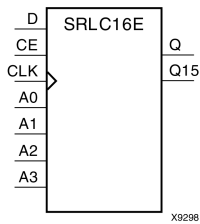

## Introduction

This design element is a shift register look-up table (LUT) with carry and clock enable. The inputs A3, A2, A1, and A0 select the output length of the shift register.

The shift register can be of a fixed, static length or it can be dynamically adjusted.

- **To create a fixed-length shift register** -Drive the A3 through A0 inputs with static values. The length of the shift register can vary from 1 bit to 16 bits, as determined by the following formula: Length =  $(8 \times A3) + (4 \times A2) + (2 \times A1) + A0 + 1$ . If A3, A2, A1, and A0 are all zeros (0000), the shift register is one bit long. If they are all ones (1111), it is 16 bits long.
- **To change the length of the shift register dynamically** -Change the values driving the A3 through A0 inputs. For example, if A2, A1, and A0 are all ones (111) and A3 toggles between a one (1) and a zero (0), the length of the shift register changes from 16 bits to 8 bits. Internally, the length of the shift register is always 16 bits and the input lines A3 through A0 select which of the 16 bits reach the output.

The shift register LUT contents are initialized by assigning a four-digit hexadecimal number to an INIT attribute. The first, or the left-most, hexadecimal digit is the most significant bit. If an INIT value is not specified, it defaults to a value of four zeros (0000) so that the shift register LUT is cleared during configuration.

The data (D) is loaded into the first bit of the shift register during the Low-to-High clock (CLK) transition. When CE is High, during subsequent Low-to-High clock transitions, data shifts to the next highest bit position as new data is loaded. The data appears on the Q output when the shift register length determined by the address inputs is reached.

**Note** The Q15 output is available for you in cascading to multiple shift register LUTs to create larger shift registers.

## Logic Table

Inputs				Output	
Am	CLK	CE	D	Q	Q15
Am	X	0	X	Q(Am)	Q(15)
Am	X	1	X	Q(Am)	Q(15)
Am	↑	1	D	Q(Am - 1)	Q15
m= 0, 1, 2, 3					

## Design Entry Method

This design element can be used in schematics.



## Available Attributes

Attribute	Data Type	Allowed Values	Default	Description
INIT	Hexadecimal	Any 16-Bit Value	All zeros	Sets the initial value of content and output of shift register after configuration.

## For More Information

See the [Spartan-6 FPGA User Documentation \(User Guides and Data Sheets\)](#).

## SRLC16E\_1

Primitive: 16-Bit Shift Register Look-Up Table (LUT) with Carry, Negative-Edge Clock, and Clock Enable

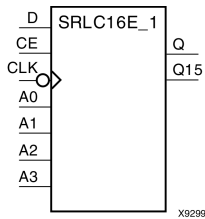

### Introduction

This design element is a shift register look-up table (LUT) with carry, clock enable, and negative-edge clock. The inputs A3, A2, A1, and A0 select the output length of the shift register.

The shift register can be of a fixed, static length or it can be dynamically adjusted.

- **To create a fixed-length shift register** -Drive the A3 through A0 inputs with static values. The length of the shift register can vary from 1 bit to 16 bits, as determined by the following formula: Length =  $(8 \times A3) + (4 \times A2) + (2 \times A1) + A0 + 1$ . If A3, A2, A1, and A0 are all zeros (0000), the shift register is one bit long. If they are all ones (1111), it is 16 bits long.
- **To change the length of the shift register dynamically** -Change the values driving the A3 through A0 inputs. For example, if A2, A1, and A0 are all ones (111) and A3 toggles between a one (1) and a zero (0), the length of the shift register changes from 16 bits to 8 bits. Internally, the length of the shift register is always 16 bits and the input lines A3 through A0 select which of the 16 bits reach the output.

The shift register LUT contents are initialized by assigning a four-digit hexadecimal number to an INIT attribute. The first, or the left-most, hexadecimal digit is the most significant bit. If an INIT value is not specified, it defaults to a value of four zeros (0000) so that the shift register LUT is cleared during configuration.

When CE is High, the data (D) is loaded into the first bit of the shift register during the High-to-Low clock (CLK) transition. During subsequent High-to-Low clock transitions data shifts to the next highest bit position as new data is loaded when CE is High. The data appears on the Q output when the shift register length determined by the address inputs is reached.

**Note** The Q15 output is available for your use in cascading multiple shift register LUTs to create larger shift registers.

### Logic Table

Inputs				Output	
A <sub>m</sub>	CE	CLK	D	Q	Q15
A <sub>m</sub>	0	X	X	Q(A <sub>m</sub> )	No Change
A <sub>m</sub>	1	X	X	Q(A <sub>m</sub> )	No Change
A <sub>m</sub>	1	↓	D	Q(A <sub>m</sub> - 1)	Q14
m = 0, 1, 2, 3					

### Design Entry Method

This design element can be used in schematics.

## Available Attributes

Attribute	Data Type	Allowed Values	Default	Description
INIT	Hexadecimal	Any 16-Bit Value	All zeros	Sets the initial value of content and output of shift register after configuration.

## For More Information

See the [Spartan-6 FPGA User Documentation \(User Guides and Data Sheets\)](#).

## SRLC32E

Primitive: 32 Clock Cycle, Variable Length Shift Register Look-Up Table (LUT) with Clock Enable

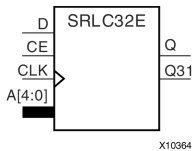

### Introduction

This design element is a variable length, 1 to 32 clock cycle shift register implemented within a single look-up table (LUT). The shift register can be of a fixed length, static length, or it can be dynamically adjusted by changing the address lines to the component. This element also features an active, high-clock enable and a cascading feature in which multiple SRLC32Es can be cascaded in order to create greater shift lengths.

### Port Descriptions

Port	Direction	Width	Function
Q	Output	1	Shift register data output
Q31	Output	1	Shift register cascaded output (connect to the D input of a subsequent SRLC32E)
D	Input	1	Shift register data input
CLK	Input	1	Clock
CE	Input	1	Active high clock enable
A	Input	5	Dynamic depth selection of the SRL A=00000 ==> 1-bit shift length A=11111 ==> 32-bit shift length

### Design Entry Method

This design element can be used in schematics.

If instantiated, the following connections should be made to this component:

- Connect the CLK input to the desired clock source, the D input to the data source to be shifted/stored and the Q output to either an FDCPE or an FDRSE input or other appropriate data destination.
- The CE clock enable pin can be connected to a clock enable signal in the design or else tied to a logic one if not used.
- The 5-bit A bus can either be tied to a static value between 0 and 31 to signify a fixed 1 to 32 bit static shift length, or else it can be tied to the appropriate logic to enable a varying shift depth anywhere between 1 and 32 bits.
- If you want to create a longer shift length than 32, connect the Q31 output pin to the D input pin of a subsequent SRLC32E to cascade and create larger shift registers.
- It is not valid to connect the Q31 output to anything other than another SRLC32E.
- The selectable Q output is still available in the cascaded mode, if needed.
- An optional INIT attribute consisting of a 32-bit Hexadecimal value can be specified to indicate the initial shift pattern of the shift register.
- (INIT[0] will be the first value shifted out.)

## Available Attributes

Attribute	Type	Allowed Values	Default	Description
INIT	Hexa-decimal	Any 32-Bit Value	All zeros	Specifies the initial shift pattern of the SRLC32E.

## For More Information

- See the [Spartan-6 FPGA Configurable Logic Block User Guide \(UG384\)](#).
- See the [Spartan-6 FPGA Data Sheet: DC and Switching Characteristics \(DS162\)](#).

## STARTUP\_SPARTAN6

Primitive: Spartan®-6 Global Set/Reset, Global 3-State and Configuration Start-Up Clock Interface

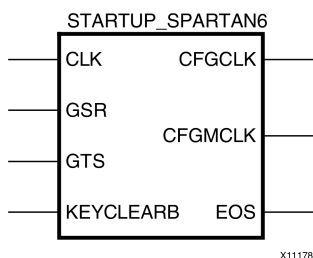

### Introduction

This design element is used to interface device pins and logic to the Global Set/Reset (GSR) signal, the Global Tristate (GTS) dedicated routing, the internal configuration signals, or the input pins for the SPI PROM if an SPI PROM is used to configure the device. This primitive can also be used to specify a different clock for the device startup sequence at the end of configuring the device, and to access the configuration clock to the internal logic.

### Port Descriptions

Port	Direction	Width	Function
CFGCLK	Output	1	Configuration logic main clock output.
CFGMCLK	Output	1	Configuration internal oscillator clock output.
CLK	Input	1	User startup-clock input
EOS	Output	1	Active high output signal indicates the End Of Configuration.
GSR	Input	1	Global Set/Reset (GSR) input (GSR cannot be used for the port name).
GTS	Input	1	Global Tristate (GTS) input (GTS cannot be used for the port name).
KEYCLEARB	Input	1	Clear AES Decrypter Key input from Battery-Backed RAM (BBRAM).

### Design Entry Method

This design element can be used in schematics.

To use the dedicated GSR circuitry, connect the sourcing pin or logic to the GSR pin. However, avoid using the GSR circuitry of this component unless certain precautions are taken first. Since the skew of the GSR net cannot be guaranteed, either use general routing for the set/reset signal in which routing delays and skew can be calculated as a part of the timing analysis of the design, or to take preventative measures to ensure that possible skew on the release of the clock cycle does not interfere with circuit operation.

Similarly, if the dedicated global 3-state is used, connect the appropriate sourcing pin or logic to the GTS input pin of the primitive. To specify a clock for the startup sequence of configuration, connect a clock from the design to the CLK pin of this design element.

### For More Information

- See the [Spartan-6 FPGA Configuration User Guide](#)
- See the [Spartan-6 FPGA Data Sheet: DC and Switching Characteristics](#).

## SUSPEND\_SYNC

### Primitive: Suspend Mode Access

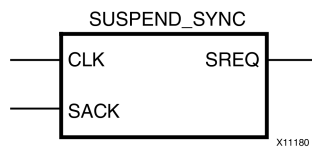

### Introduction

The SUSPEND primitive extends the capabilities of the user to synchronize the design for applications using the suspend mode. It uses a three-pin interface to allow synchronization of the trigger to start the suspend mode, even when there are several clock domains requiring synchronization.

### Port Descriptions

Port	Direction	Width	Function
CLK	Input	1	User clock input.
SACK	Input	1	SUSPEND acknowledgement output.
SREQ	Output	1	Suspend request output.

### Design Entry Method

This design element can be used in schematics.

### For More Information

- See the [Spartan-6 FPGA Configuration User Guide](#)
- See the [Spartan-6 FPGA Data Sheet: DC and Switching Characteristics](#).

# VCC

## Primitive: VCC-Connection Signal Tag



## Introduction

This design element serves as a signal tag, or parameter, that forces a net or input function to a logic High level. A net tied to this element cannot have any other source.

When the placement and routing software encounters a net or input function tied to this element, it removes any logic that is disabled by the Vcc signal, which is only implemented when the disabled logic cannot be removed.

## Design Entry Method

This design element is only for use in schematics.

## For More Information

See the [Spartan-6 FPGA User Documentation \(User Guides and Data Sheets\)](#).



## XNOR2

### Primitive: 2-Input XNOR Gate with Non-Inverted Inputs

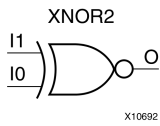

## Introduction

XNOR elements implement Negated XOR. A High (1) output results if there are an even number of High (1) inputs. A Low (0) output results if there is an odd number of High (1) inputs.

XNOR functions of up to nine inputs are available. All inputs are non-inverting. Because each input uses a CLB resource, replace functions with unused inputs with functions having the necessary number of inputs.

## Logic Table

Input	Output
I0 ... Iz	O
Odd number of 1	0
Even number of 1	1

## Design Entry Method

This design element is only for use in schematics.

## For More Information

See the [Spartan-6 FPGA User Documentation \(User Guides and Data Sheets\)](#).

## XNOR3

### Primitive: 3-Input XNOR Gate with Non-Inverted Inputs

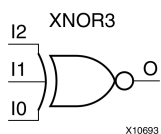

## Introduction

XNOR elements implement Negated XOR. A High (1) output results if there are an even number of High (1) inputs. A Low (0) output results if there is an odd number of High (1) inputs.

XNOR functions of up to nine inputs are available. All inputs are non-inverting. Because each input uses a CLB resource, replace functions with unused inputs with functions having the necessary number of inputs.

## Logic Table

Input	Output
I0 ... Iz	O
Odd number of 1	0
Even number of 1	1

## Design Entry Method

This design element is only for use in schematics.

## For More Information

See the [Spartan-6 FPGA User Documentation \(User Guides and Data Sheets\)](#).

## XNOR4

### Primitive: 4-Input XNOR Gate with Non-Inverted Inputs

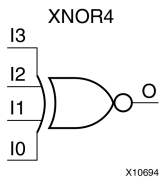

## Introduction

XNOR elements implement Negated XOR. A High (1) output results if there are an even number of High (1) inputs. A Low (0) output results if there is an odd number of High (1) inputs.

XNOR functions of up to nine inputs are available. All inputs are non-inverting. Because each input uses a CLB resource, replace functions with unused inputs with functions having the necessary number of inputs.

## Logic Table

Input	Output
I0 ... Iz	O
Odd number of 1	0
Even number of 1	1

## Design Entry Method

This design element is only for use in schematics.

## For More Information

See the [Spartan-6 FPGA User Documentation \(User Guides and Data Sheets\)](#).

## XNOR5

### Primitive: 5-Input XNOR Gate with Non-Inverted Inputs

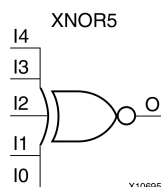

## Introduction

XNOR elements implement Negated XOR. A High (1) output results if there are an even number of High (1) inputs. A Low (0) output results if there is an odd number of High (1) inputs.

XNOR functions of up to nine inputs are available. All inputs are non-inverting. Because each input uses a CLB resource, replace functions with unused inputs with functions having the necessary number of inputs.

## Logic Table

Input	Output
I0 ... Iz	O
Odd number of 1	0
Even number of 1	1

## Design Entry Method

This design element is only for use in schematics.

## For More Information

See the [Spartan-6 FPGA User Documentation \(User Guides and Data Sheets\)](#).

## XNOR6

### Macro: 6-Input XNOR Gate with Non-Inverted Inputs

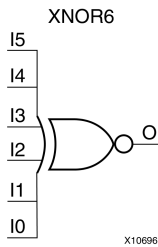

## Introduction

XNOR elements implement Negated XOR. A High (1) output results if there are an even number of High (1) inputs. A Low (0) output results if there is an odd number of High (1) inputs.

XNOR functions of up to nine inputs are available. All inputs are non-inverting. Because each input uses a CLB resource, replace functions with unused inputs with functions having the necessary number of inputs.

## Logic Table

Input	Output
I0 ... Iz	O
Odd number of 1	0
Even number of 1	1

## Design Entry Method

This design element is only for use in schematics.

## For More Information

See the [Spartan-6 FPGA User Documentation \(User Guides and Data Sheets\)](#).

## XNOR7

### Macro: 7-Input XNOR Gate with Non-Inverted Inputs

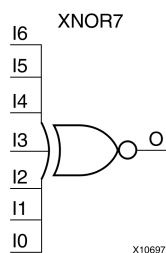

## Introduction

XNOR elements implement Negated XOR. A High (1) output results if there are an even number of High (1) inputs. A Low (0) output results if there is an odd number of High (1) inputs.

XNOR functions of up to nine inputs are available. All inputs are non-inverting. Because each input uses a CLB resource, replace functions with unused inputs with functions having the necessary number of inputs.

## Logic Table

Input	Output
I0 ... Iz	O
Odd number of 1	0
Even number of 1	1

## Design Entry Method

This design element is only for use in schematics.

## For More Information

See the [Spartan-6 FPGA User Documentation \(User Guides and Data Sheets\)](#).

## XNOR8

### Macro: 8-Input XNOR Gate with Non-Inverted Inputs

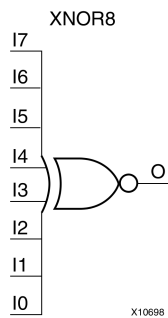

### Introduction

XNOR elements implement Negated XOR. A High (1) output results if there are an even number of High (1) inputs. A Low (0) output results if there is an odd number of High (1) inputs.

XNOR functions of up to nine inputs are available. All inputs are non-inverting. Because each input uses a CLB resource, replace functions with unused inputs with functions having the necessary number of inputs.

### Logic Table

Input	Output
I0 ... Iz	0
Odd number of 1	0
Even number of 1	1

### Design Entry Method

This design element is only for use in schematics.

### For More Information

See the [Spartan-6 FPGA User Documentation \(User Guides and Data Sheets\)](#).

## XNOR9

### Macro: 9-Input XNOR Gate with Non-Inverted Inputs

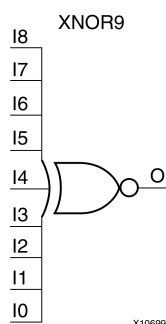

## Introduction

XNOR elements implement Negated XOR. A High (1) output results if there are an even number of High (1) inputs. A Low (0) output results if there is an odd number of High (1) inputs.

XNOR functions of up to nine inputs are available. All inputs are non-inverting. Because each input uses a CLB resource, replace functions with unused inputs with functions having the necessary number of inputs.

## Logic Table

Input	Output
I0 ... Iz	O
Odd number of 1	0
Even number of 1	1

## Design Entry Method

This design element is only for use in schematics.

## For More Information

See the [Spartan-6 FPGA User Documentation \(User Guides and Data Sheets\)](#).



## XOR2

### Primitive: 2-Input XOR Gate with Non-Inverted Inputs

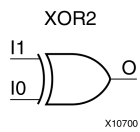

## Introduction

XOR elements implement exclusive OR. A High (1) output results if there are an odd number of High (1) inputs. A Low (0) output results if there is an even number of High (1) inputs.

XOR functions of up to nine inputs are available. All inputs are non-inverting. Because each input uses a CLB resource, replace functions with unused inputs with functions having the necessary number of inputs.

## Logic Table

Input	Output
I0 ... Iz	O
Odd number of 1	1
Even number of 1	0

## Design Entry Method

This design element is only for use in schematics.

## For More Information

See the [Spartan-6 FPGA User Documentation \(User Guides and Data Sheets\)](#).

## XOR3

### Primitive: 3-Input XOR Gate with Non-Inverted Inputs

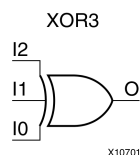

## Introduction

XOR elements implement exclusive OR. A High (1) output results if there are an odd number of High (1) inputs. A Low (0) output results if there is an even number of High (1) inputs.

XOR functions of up to nine inputs are available. All inputs are non-inverting. Because each input uses a CLB resource, replace functions with unused inputs with functions having the necessary number of inputs.

## Logic Table

Input	Output
I0 ... Iz	O
Odd number of 1	1
Even number of 1	0

## Design Entry Method

This design element is only for use in schematics.

## For More Information

See the [Spartan-6 FPGA User Documentation \(User Guides and Data Sheets\)](#).

## XOR4

### Primitive: 4-Input XOR Gate with Non-Inverted Inputs

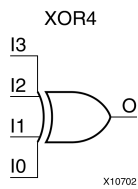

## Introduction

XOR elements implement exclusive OR. A High (1) output results if there are an odd number of High (1) inputs. A Low (0) output results if there is an even number of High (1) inputs.

XOR functions of up to nine inputs are available. All inputs are non-inverting. Because each input uses a CLB resource, replace functions with unused inputs with functions having the necessary number of inputs.

## Logic Table

Input	Output
I0 ... Iz	0
Odd number of 1	1
Even number of 1	0

## Design Entry Method

This design element is only for use in schematics.

## For More Information

See the [Spartan-6 FPGA User Documentation \(User Guides and Data Sheets\)](#).

## XOR5

### Primitive: 5-Input XOR Gate with Non-Inverted Inputs

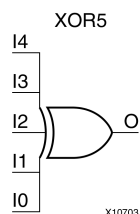

## Introduction

XOR elements implement exclusive OR. A High (1) output results if there are an odd number of High (1) inputs. A Low (0) output results if there is an even number of High (1) inputs.

XOR functions of up to nine inputs are available. All inputs are non-inverting. Because each input uses a CLB resource, replace functions with unused inputs with functions having the necessary number of inputs.

## Logic Table

Input	Output
I0 ... Iz	O
Odd number of 1	1
Even number of 1	0

## Design Entry Method

This design element is only for use in schematics.

## For More Information

See the [Spartan-6 FPGA User Documentation \(User Guides and Data Sheets\)](#).

## XOR6

### Macro: 6-Input XOR Gate with Non-Inverted Inputs

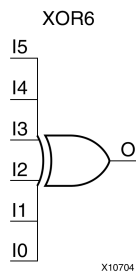

### Introduction

XOR elements implement exclusive OR. A High (1) output results if there are an odd number of High (1) inputs. A Low (0) output results if there is an even number of High (1) inputs.

XOR functions of up to nine inputs are available. All inputs are non-inverting. Because each input uses a CLB resource, replace functions with unused inputs with functions having the necessary number of inputs.

### Logic Table

Input	Output
I0 ... Iz	0
Odd number of 1	1
Even number of 1	0

### Design Entry Method

This design element is only for use in schematics.

### For More Information

See the [Spartan-6 FPGA User Documentation \(User Guides and Data Sheets\)](#).

## XOR7

### Macro: 7-Input XOR Gate with Non-Inverted Inputs

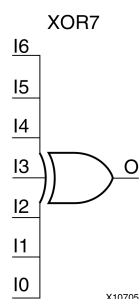

## Introduction

XOR elements implement exclusive OR. A High (1) output results if there are an odd number of High (1) inputs. A Low (0) output results if there is an even number of High (1) inputs.

XOR functions of up to nine inputs are available. All inputs are non-inverting. Because each input uses a CLB resource, replace functions with unused inputs with functions having the necessary number of inputs.

## Logic Table

Input	Output
I0 ... Iz	O
Odd number of 1	1
Even number of 1	0

## Design Entry Method

This design element is only for use in schematics.

## For More Information

See the [Spartan-6 FPGA User Documentation \(User Guides and Data Sheets\)](#).

## XOR8

### Macro: 8-Input XOR Gate with Non-Inverted Inputs

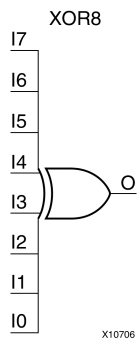

### Introduction

XOR elements implement exclusive OR. A High (1) output results if there are an odd number of High (1) inputs. A Low (0) output results if there is an even number of High (1) inputs.

XOR functions of up to nine inputs are available. All inputs are non-inverting. Because each input uses a CLB resource, replace functions with unused inputs with functions having the necessary number of inputs.

### Logic Table

Input	Output
I0 ... Iz	O
Odd number of 1	1
Even number of 1	0

### Design Entry Method

This design element is only for use in schematics.

### For More Information

See the [Spartan-6 FPGA User Documentation \(User Guides and Data Sheets\)](#).

## XOR9

### Macro: 9-Input XOR Gate with Non-Inverted Inputs

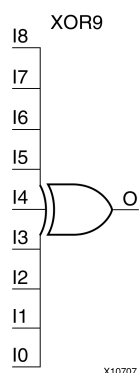

### Introduction

XOR elements implement exclusive OR. A High (1) output results if there are an odd number of High (1) inputs. A Low (0) output results if there is an even number of High (1) inputs.

XOR functions of up to nine inputs are available. All inputs are non-inverting. Because each input uses a CLB resource, replace functions with unused inputs with functions having the necessary number of inputs.

### Logic Table

Input	Output
I0 ... Iz	O
Odd number of 1	1
Even number of 1	0

### Design Entry Method

This design element is only for use in schematics.

### For More Information

See the [Spartan-6 FPGA User Documentation \(User Guides and Data Sheets\)](#).



# XORCY

## Primitive: XOR for Carry Logic with General Output

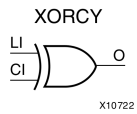

## Introduction

This design element is a special XOR with general O output that generates faster and smaller arithmetic functions. The XORCY primitive is a dedicated XOR function within the carry-chain logic of the slice. It allows for fast and efficient creation of arithmetic (add/subtract) or wide logic functions (large AND/OR gate).

## Logic Table

Input		Output
LI	CI	O
0	0	0
0	1	1
1	0	1
1	1	0

## Design Entry Method

This design element can be used in schematics.

## For More Information

See the [Spartan-6 FPGA User Documentation \(User Guides and Data Sheets\)](#).

## XORCY\_D

Primitive: XOR for Carry Logic with Dual Output

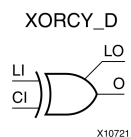

### Introduction

This design element is a special XOR that generates faster and smaller arithmetic functions.

### Logic Table

Input		Output
LI	CI	O and LO
0	0	0
0	1	1
1	0	1
1	1	0

### Design Entry Method

This design element can be used in schematics.

### For More Information

See the [Spartan-6 FPGA User Documentation \(User Guides and Data Sheets\)](#).

## XORCY\_L

### Primitive: XOR for Carry Logic with Local Output

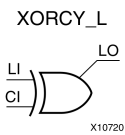

## Introduction

This design element is a special XOR with local LO output that generates faster and smaller arithmetic functions.

## Logic Table

Input		Output
LI	CI	LO
0	0	0
0	1	1
1	0	1
1	1	0

## Design Entry Method

This design element can be used in schematics.

## For More Information

See the [Spartan-6 FPGA User Documentation \(User Guides and Data Sheets\)](#).